



NINJAGO

DRAGONS RISING

71810





Q LEGO® Builder



LEGO.com/sustainable-packaging



 ^{FR} **DONNEZ**
OU
RECYCLEZ

 OU  OU 

ASSOCIATION MAGASIN DÉCHÈTERIE

Adresses sur quefairedemesdechets.fr

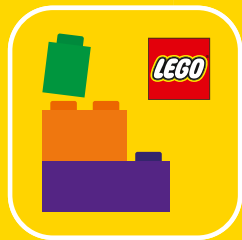

Q LEGO® Builder

BUILDER



Apple and the Apple logo are trademarks of Apple Inc., registered in the U.S. and other countries and regions. App Store is a service mark of Apple Inc. Google Play and the Google Play logo are trademarks of Google LLC. Tencent and the Tencent logo are trademarks of Tencent Inc.

Q [LEGO.com/devicecheck](https://www.lego.com/devicecheck)

EN Ask parents' permission before going online | DE Eltern um Erlaubnis bitten, bevor du online gehst | FR Demande l'autorisation d'un parent avant d'aller en ligne | IT Chiedi il permesso ai tuoi genitori prima di andare online | ES Pídeles permiso a tus papás antes de conectarte a Internet | PT Pede autorização aos pais antes de acederes online | ZH 上网前应先征得父母的同意 | PL Poproś rodziców o zgodę, zanim wejdiesz do Internetu | CS Než půjdeš na internet, požádej rodiče o svolení | SK Skôr než pôjdeš na internet, vypýtaj si povolenie od rodičov | HU Kérj szülői engedélyt, mielőtt online csatlakoznál! | RO Cere permisiunea părinților înainte de a te conecta online | BG Поискайте разрешение от родител, преди да влезете онлайн | LV Pirms došanās tiešsaistē palūdz atļauju vecākiem | ET Enne Interneti kasutamist küsi vanematelt luba | LT Prieš prisijungdami prie interneto, atsiklauskite tėvų



1

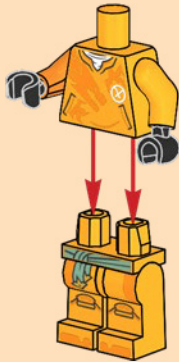

2

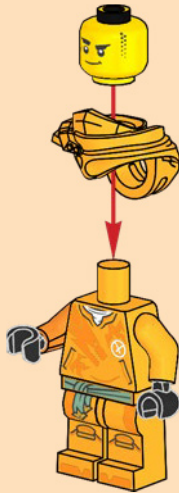

3

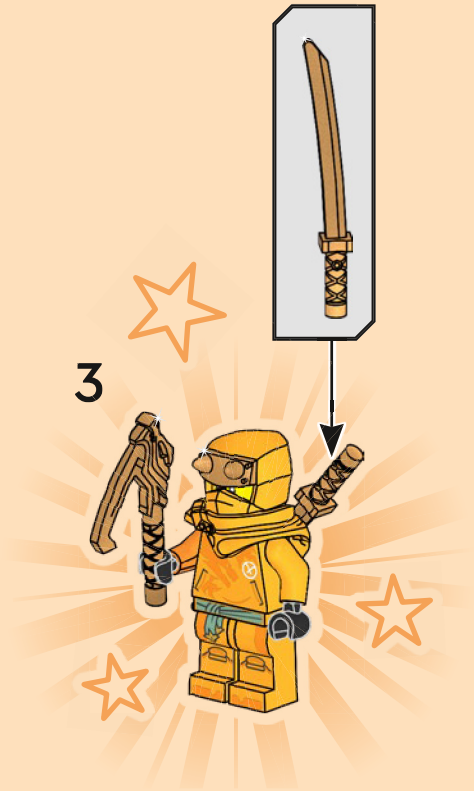

1

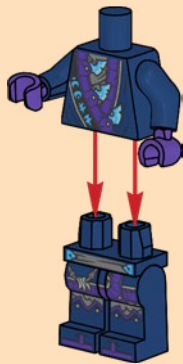

2

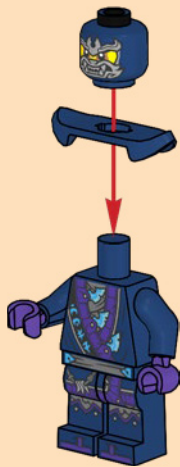

3



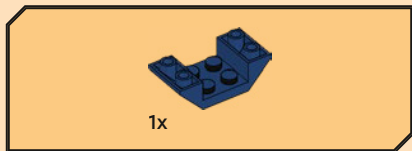
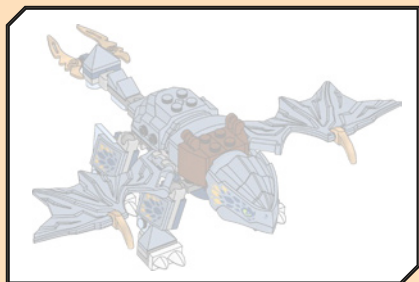

1

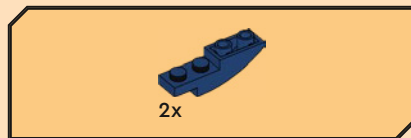
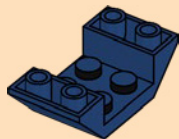

2

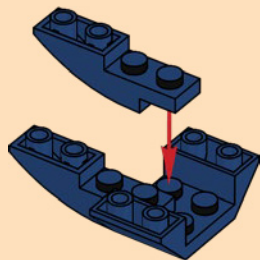

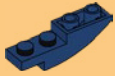

2x

3

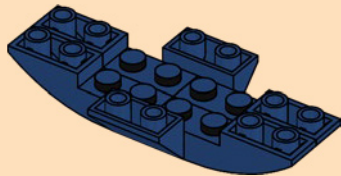

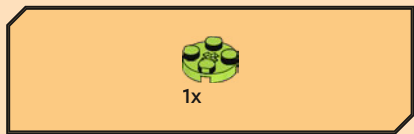

4

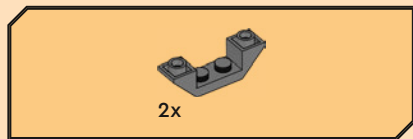
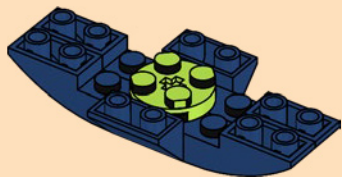

5

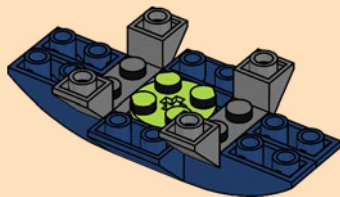



6

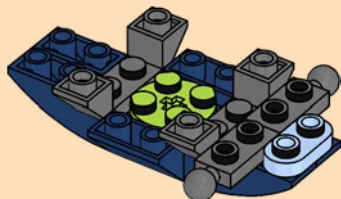

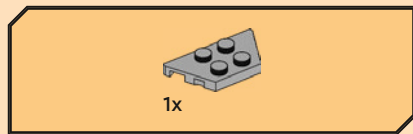

7

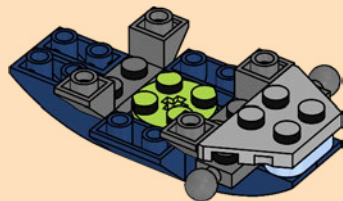

8

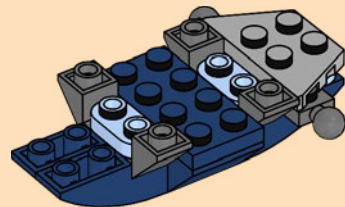



4x

9

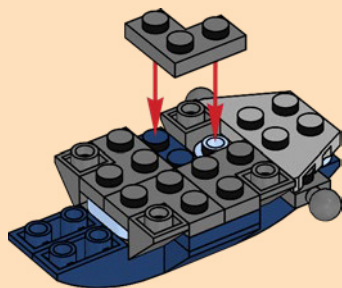

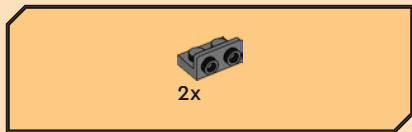

10

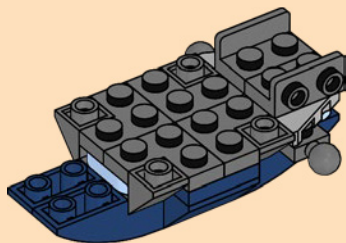

11

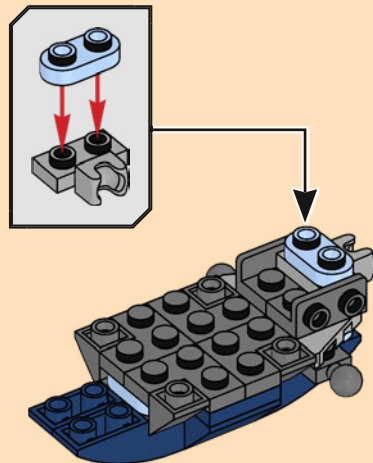



4x

12

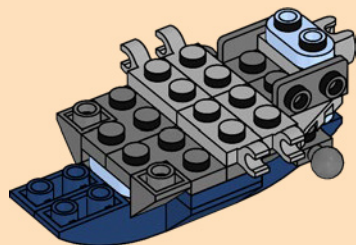

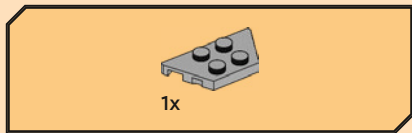

13

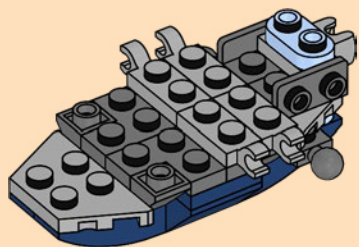

14

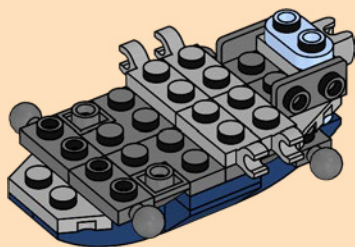



15

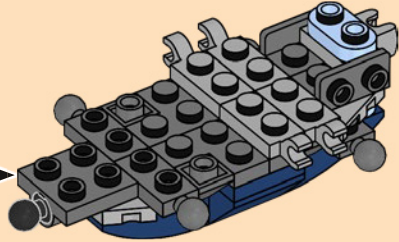
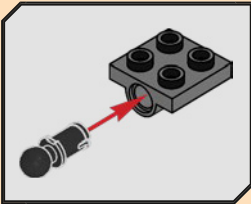



16

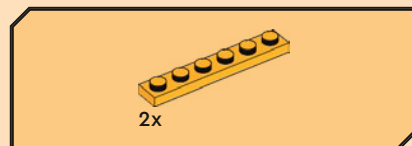
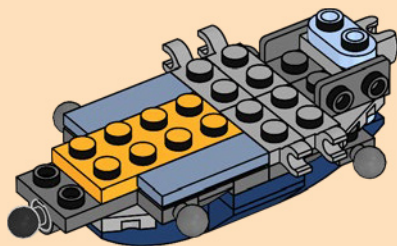

17

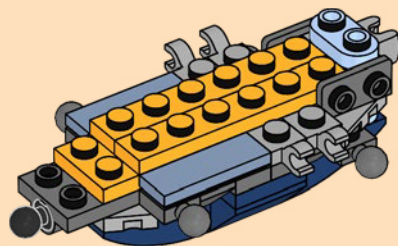



1x



1x

18

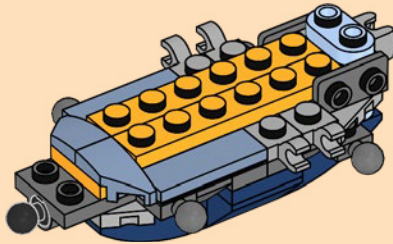

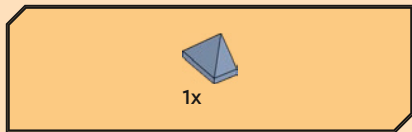

19

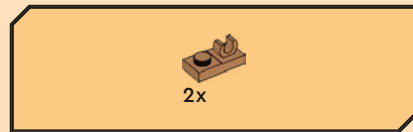
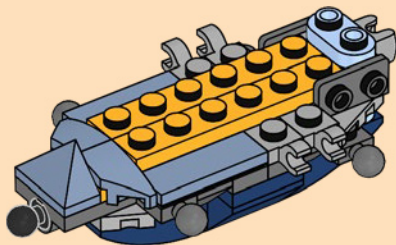

20

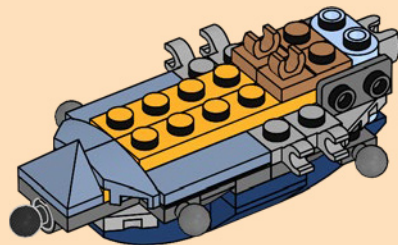

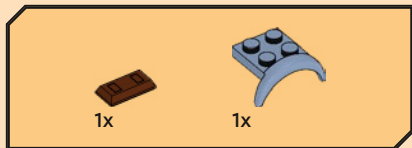

21

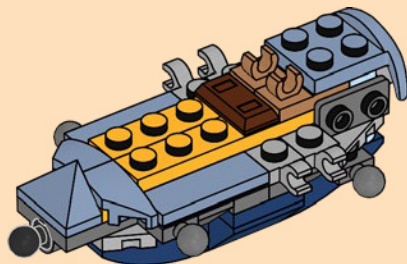



1x

22

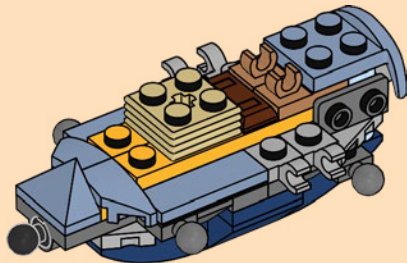

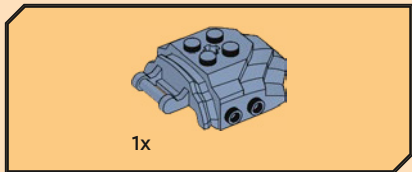

23

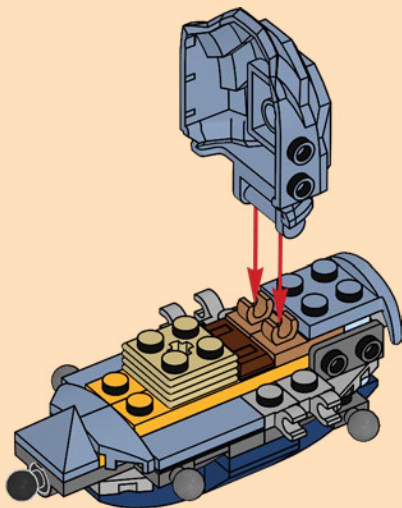

24

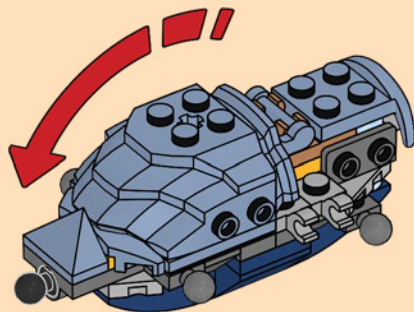



2x

25

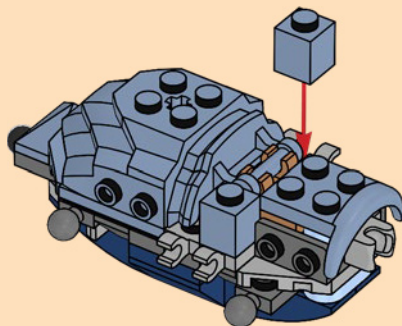

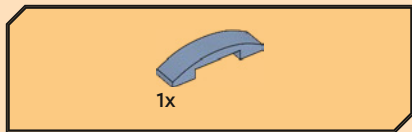

26

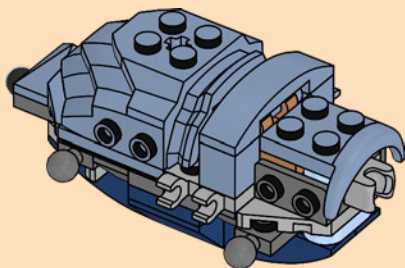

27

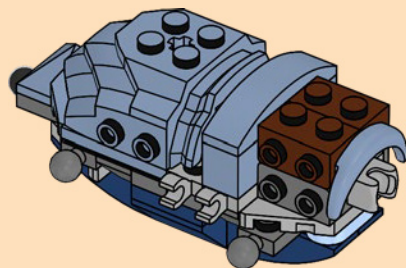



2x

28

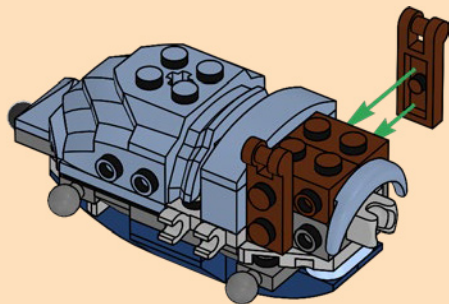



29

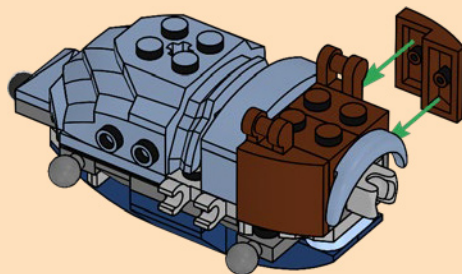

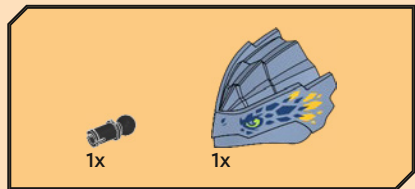

30

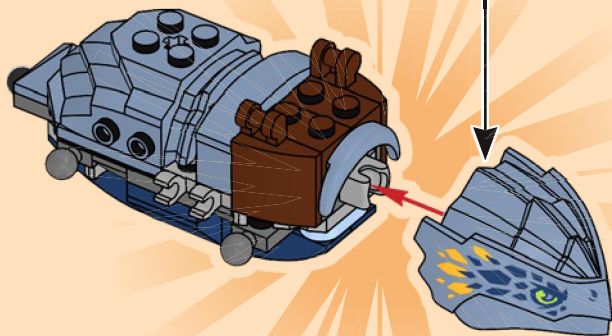
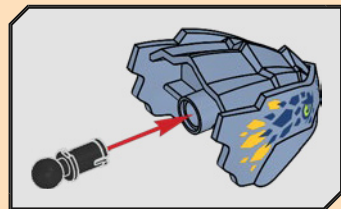



1

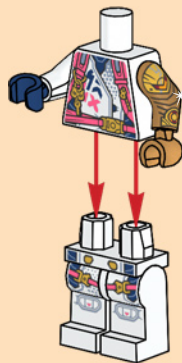

2

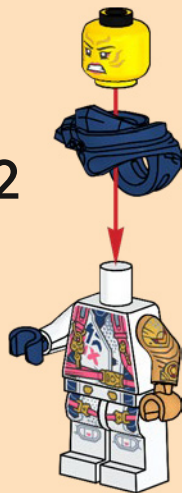

3





31

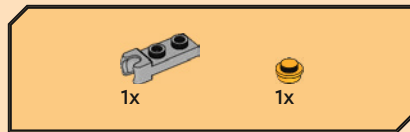

1x

1x

32



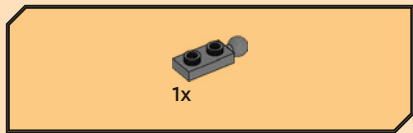

33

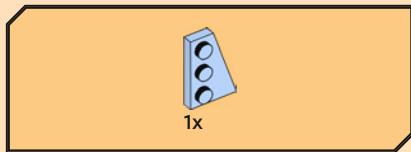

34

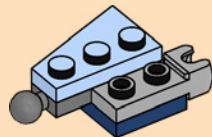

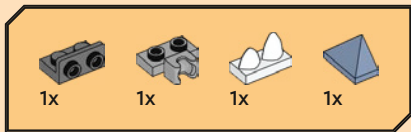

37

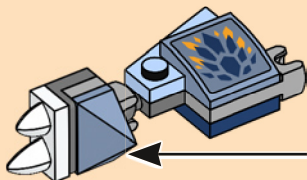
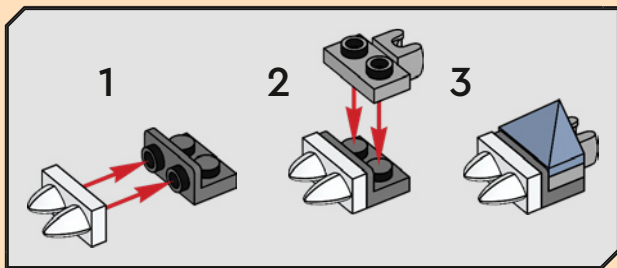

38

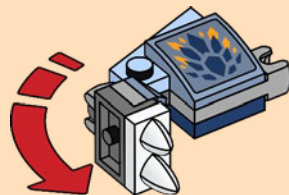

2x

39

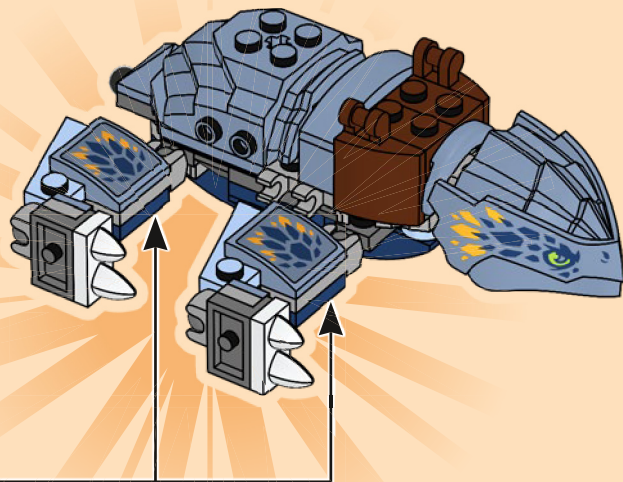

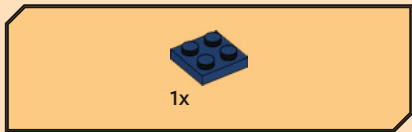

40

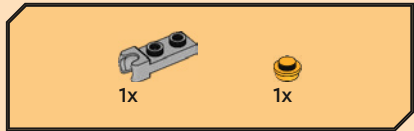

41

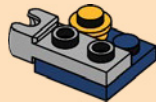

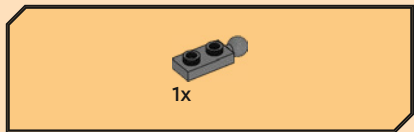

42

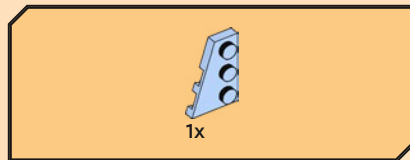
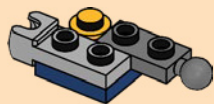

43

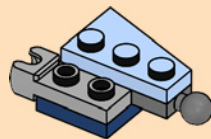

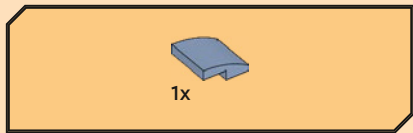

44

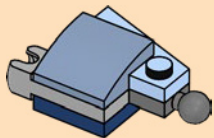

45

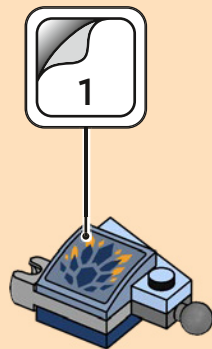

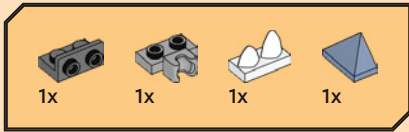

46

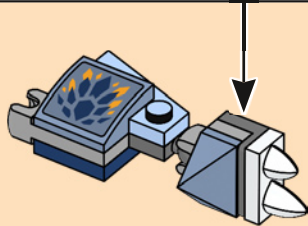
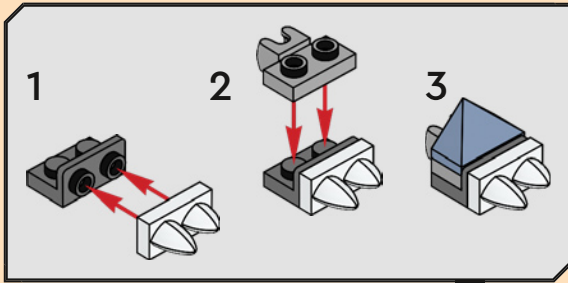

47

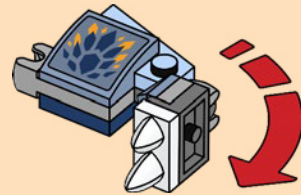

2x



48

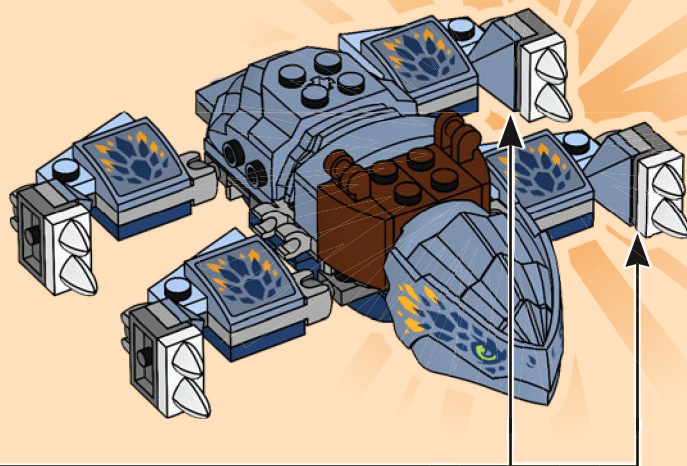

49

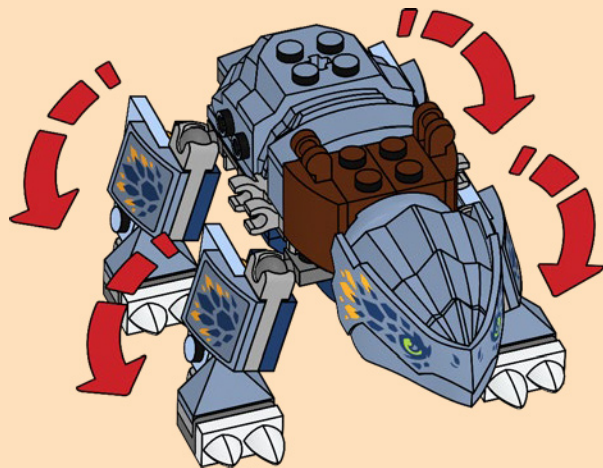



50

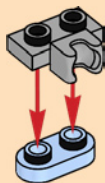

51



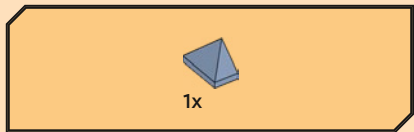

52



53

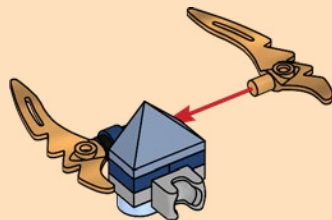

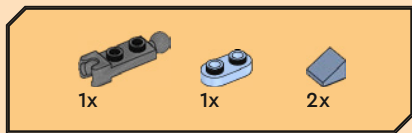

54

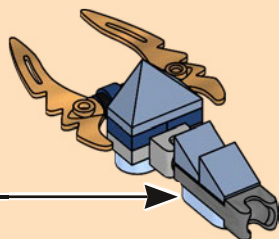
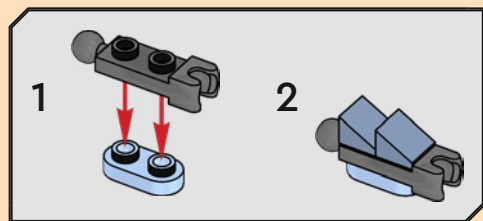

55

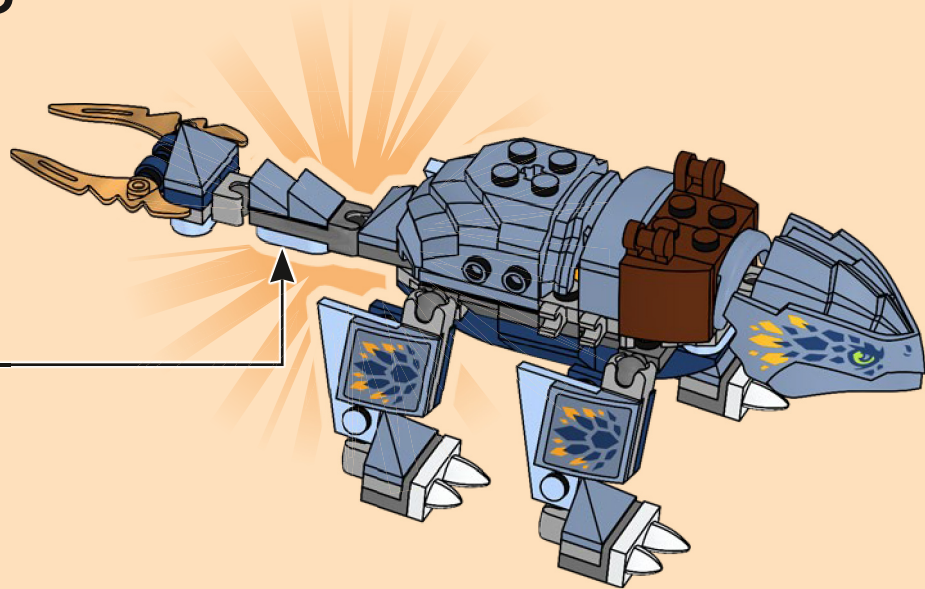

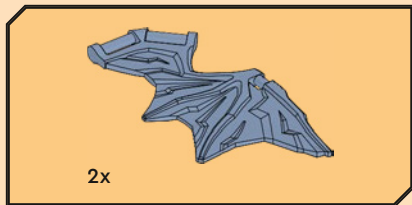

56

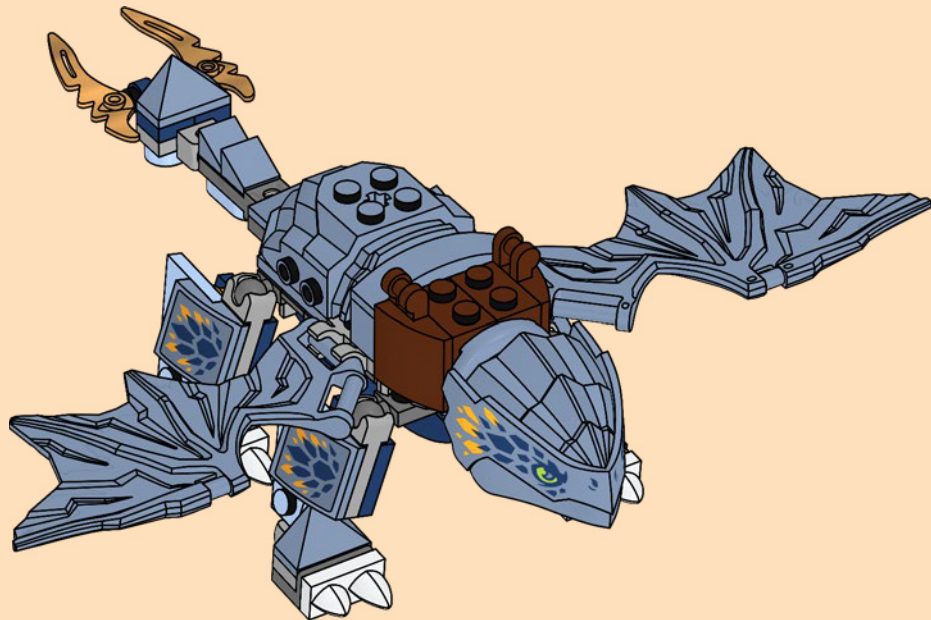



2x

57

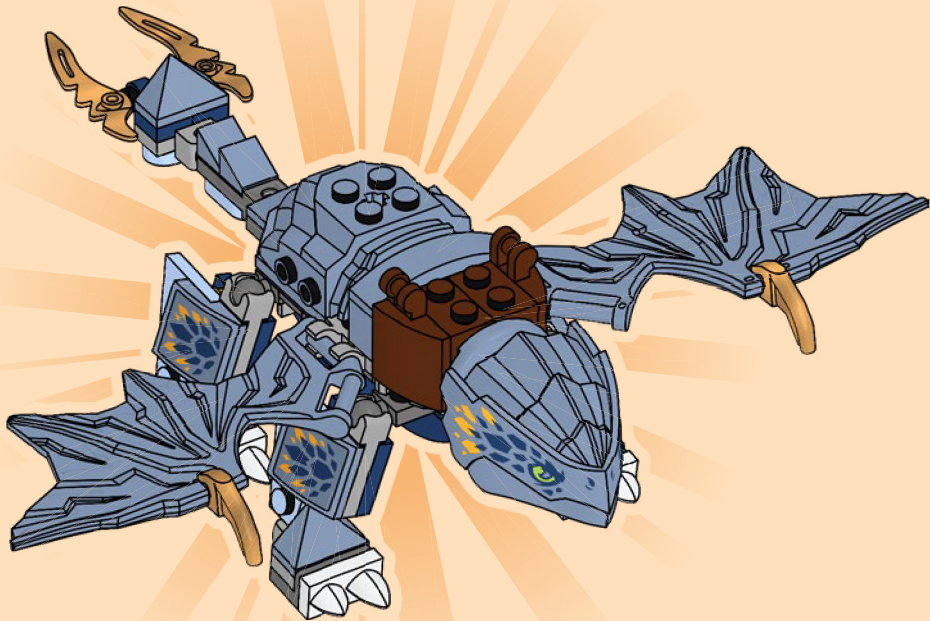

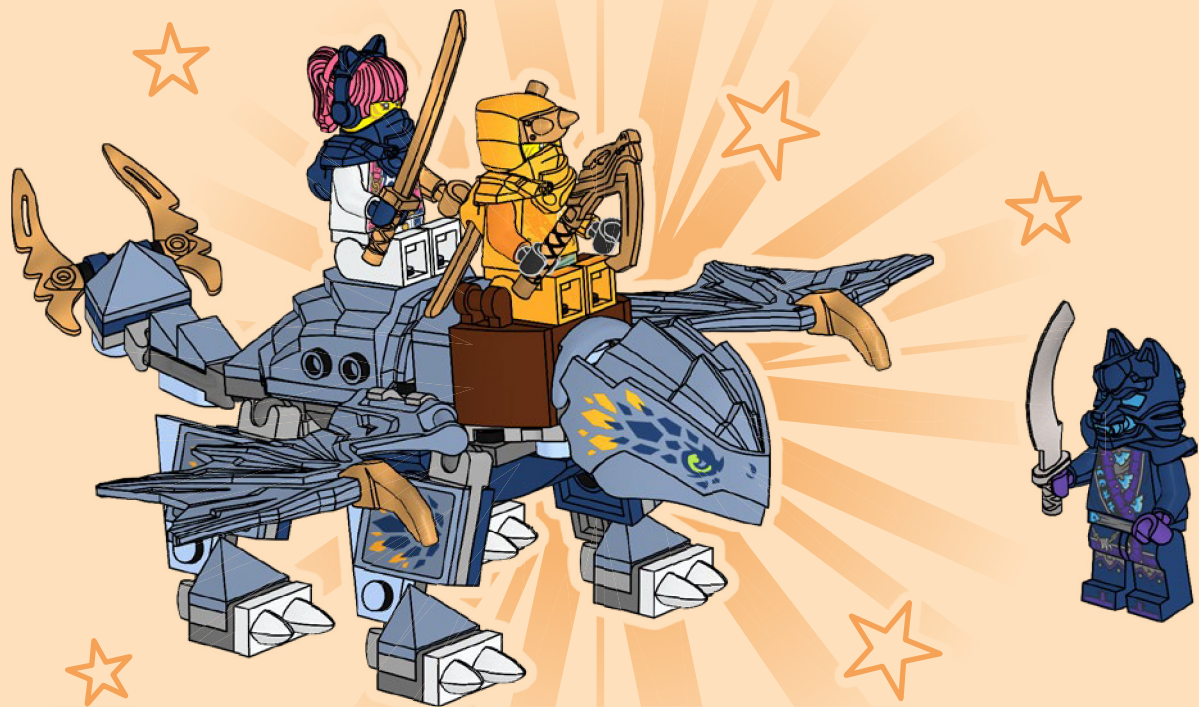

LEGO



71801



71802



71803



71806



71804



71805



71807



71808



71809



71817



71811



71810



71812



71813



71819



1x
6434456



4x
6046384



1x
6437615



1x
6330903



1x
6434457



1x
6442565



2x
6344752



1x
6314224



2x
4620077



1x
6257109



2x
6062686



1x
6257108



6x
6392959



4x
6166865



2x
6262031



1x
6475211



1x
6475223



1x
6475223



1x
6464368

1x
6464368



1x
6475208



2x
6475206



1x
6464352



1x
6468746



2x
6328107



1x
6464354



1x
6437172



1x
6315048



4x
6037890



1x
6469272



1x
6469272



4x
6199906



1x
4667595

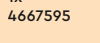

1x
6475225



1x
6434460



1x
6437173



1x
6437858



1x
6437858



1x
6097511



2x
6020074



2x
4507056

2x
4507056



4x
6331261



1x
6430278



1x
6261744



2x
6443654



2x
6146858



2x
6102975



6x
6043656



4x
6319336



4x
6043639



2x
4507056

2x
4507056



6x
6000606



8x
6123814



1x
6047417



4x
4210635



1x
6039482



2x
6185675



6x
6372122



2x
6383097



2x
6383097

2x
6383097

2x
6383097

2x
6383097

2x
6383097



1x
6476963



2x
6270138



2x
6116596



2x
6426622



2x
6426622



2x
6347304



1x
6461579



1x
6461579



1x
6466239



1x
6466239

 [LEGO.com/service](https://www.lego.com/service)



YOU COULD **WIN**



Scan this QR code or go to **LEGO.COM/PRODUCTFEEDBACK** and give us your short feedback about this LEGO® set for a chance to win a cool LEGO prize.

Terms and Conditions apply*



EN: YOU COULD WIN. Terms and Conditions apply* **DE: Du könntest GEWINNEN.** Es gelten die Teilnahmebedingungen* **FR: Tu pourrais GAGNER.** Des conditions s'appliquent* **IT: Potresti VINCERE tu.** Termini e condizioni sono applicabili* **ES: Puedes GANAR.** Aplican términos y condiciones* **PT: Poderá GANHAR.** Aplicam-se termos e condições* **ZH: 轻松获奖. 条款和条件适用*** **PL: Szansa na WYGRANA.** Obowiązują warunki korzystania* **CS: Máte šanci VYHRÁT.** Platí všeobecné smluvní podmínky* **SK: Máte šancu VYHRAŤ.** Platia všeobecné zmluvné podmienky* **HU: TE IS NYERHETSZ.** Felhasználási feltételek érvényesek* **RO: Ai putea CÂȘTIGA.** Se aplică termenii și condiții* **BG: Можете да СПЕЧЕЛИТЕ.** Има определени правила и условия* **LV: Tu vari LAIMĒT.** Ir spēkā noteikumi un nosacījumi.* **ET: Sul on võimalus VÕITA.** Kehtivad tingimused* **LT: Jūs galite LAIMĖTI.** Taikomos sąlygos*

*[LEGO.com/productfeedback-terms](https://www.lego.com/productfeedback-terms)

LEGO, the LEGO logo and NINJAGO are trademarks of the LEGO Group. ©2024 The LEGO Group.

6505907