

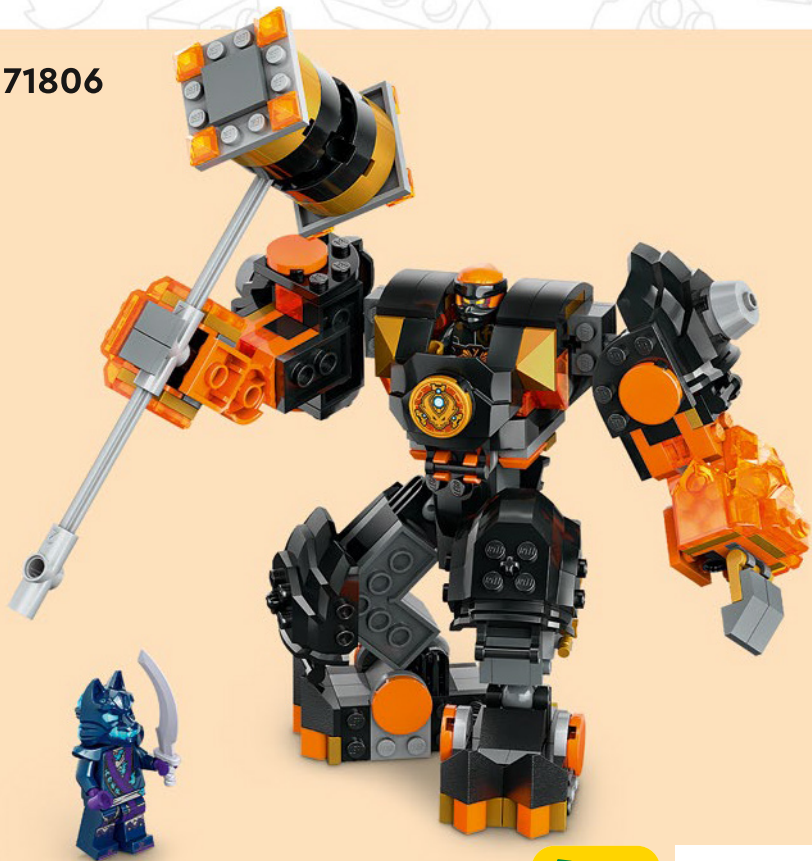

NINJAGO

DRAGONS RISING

71806





Q LEGO® Builder



LEGO.com/sustainable-packaging



FR
DONNEZ
OU
RECYCLEZ

 OU  OU 

ASSOCIATION MAGASIN DÉCHÈTERIE

Adresses sur quefairedemesdechets.fr

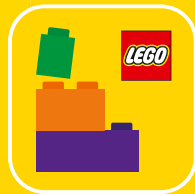

LEGO® Builder

BUILDER



Apple and the Apple logo are trademarks of Apple Inc., registered in the U.S. and other countries and regions. App Store is a service mark of Apple Inc. Google Play and the Google Play logo are trademarks of Google LLC. Tencent and the Tencent logo are trademarks of Tencent Inc.

LEGO.com/devicecheck

EN Ask parents' permission before going online | **DE** Eltern um Erlaubnis bitten, bevor du online gehst | **FR** Demande l'autorisation d'un parent avant d'aller en ligne | **IT** Chiedi il permesso ai tuoi genitori prima di andare online | **ES** Pídeles permiso a tus papás antes de conectarte a Internet | **PT** Peça autorização aos pais antes de acederes online | **ZH** 上网前应先征得父母的同意 | **PL** Poproś rodziców o zgodę, zanim wejdiesz do Internetu | **CS** Než půjdeš na internet, požádej rodiče o svolení | **SK** Skôr než pôjdeš na internet, vypýtaj si povolenie od rodičov | **HU** Kérj szülői engedélyt, mielőtt online csatlakoznál! | **RO** Cere permisiunea părinților înainte de a te conecta online | **BG** Поискайте разрешение от родител, преди да влезете онлайн | **LV** Pirms došanās tiešsaistē palūdz atļauju vecākiem | **ET** Enne Interneti kasutamist küsi vanematelt luba | **LT** Prieš prisijungdami prie interneto, atsiklauskite tėvų



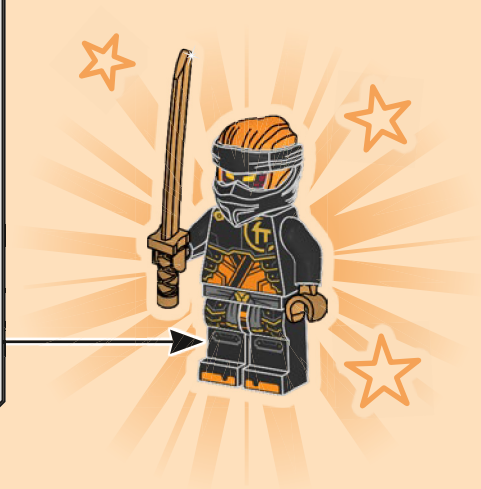
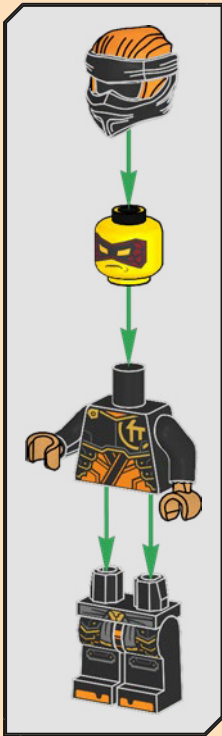

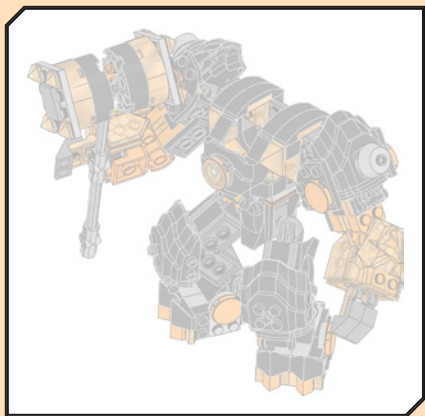

1x

1

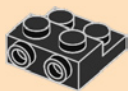

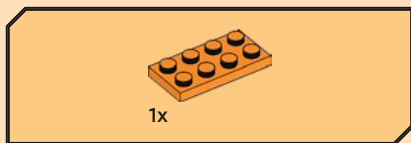

2

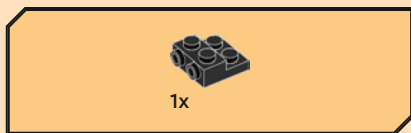
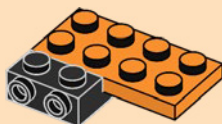

3

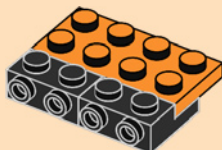

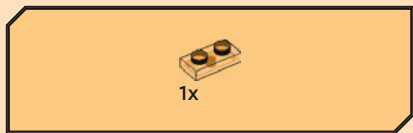

4

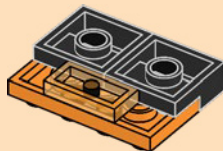

5

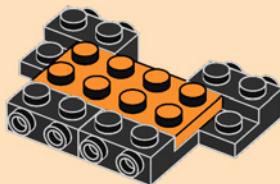

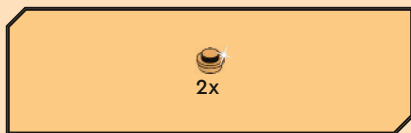

6

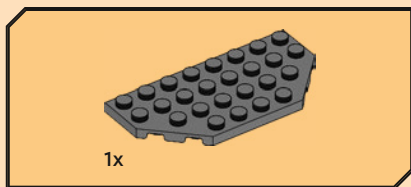
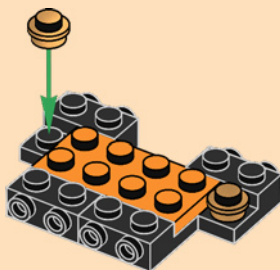

7

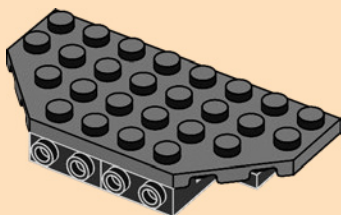

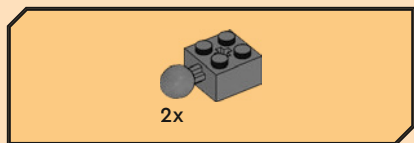

8

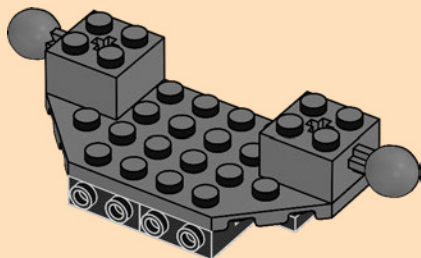

9

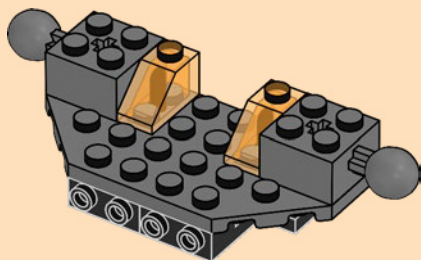

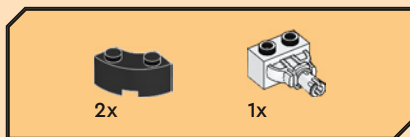

10

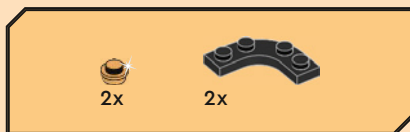
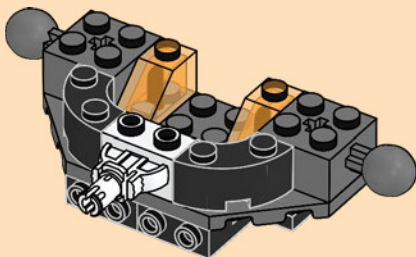

11

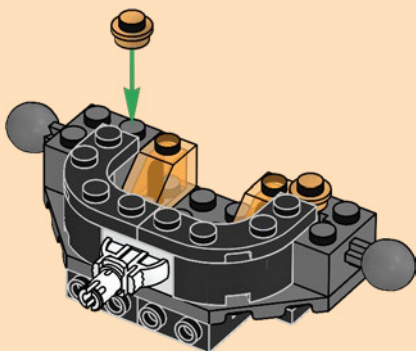



2x

12

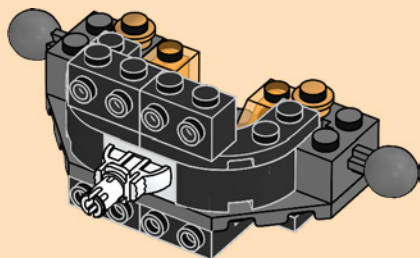

2x



1x

13

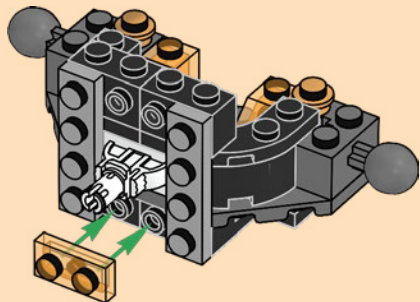



14

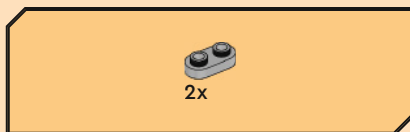
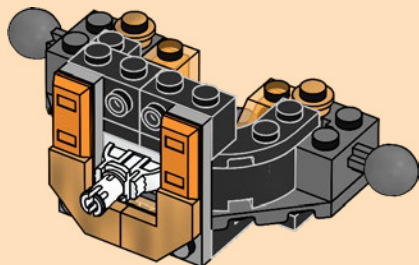

15

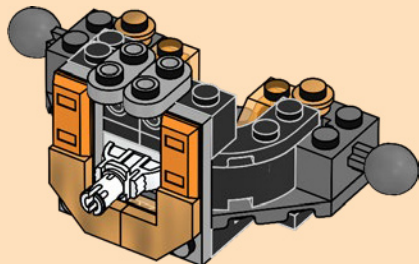

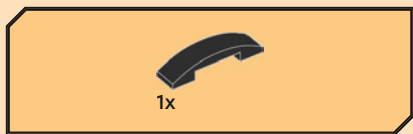

16

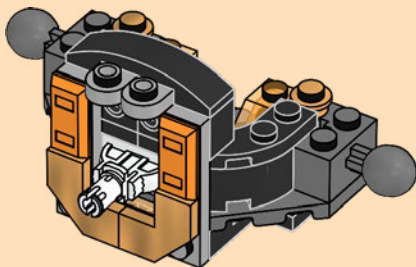

17

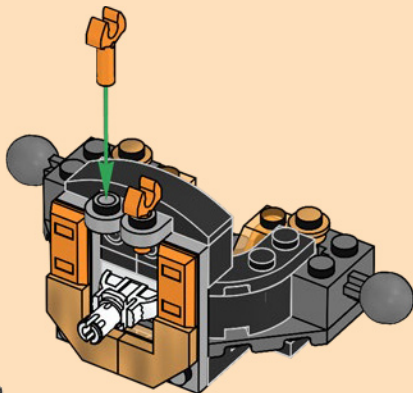



18

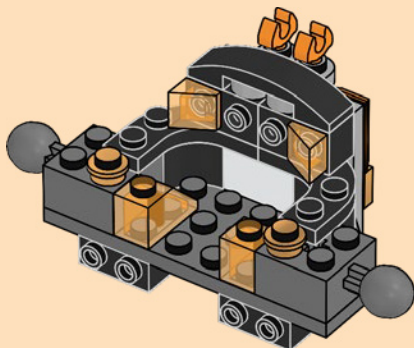

19

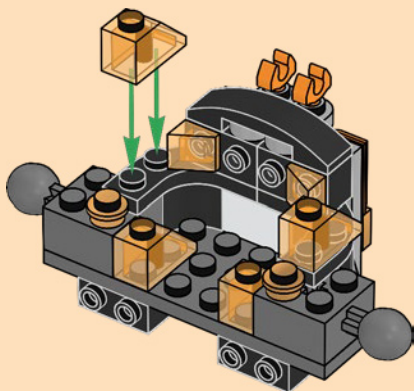



2x

20

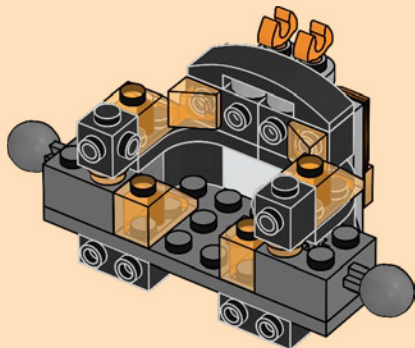

2x

21

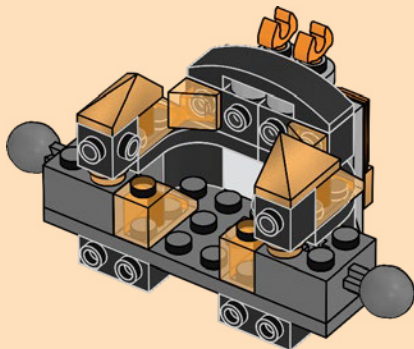

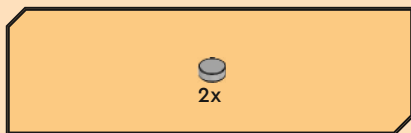

22

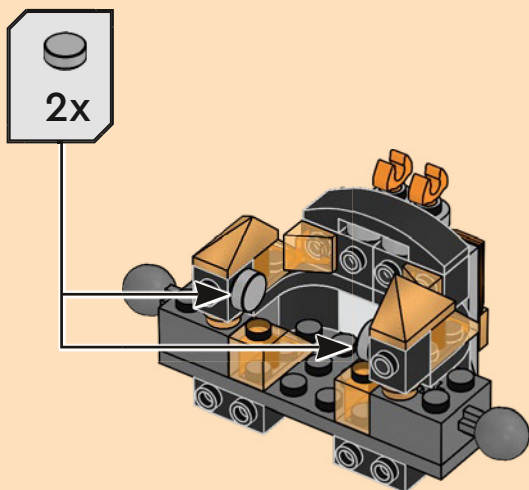



23

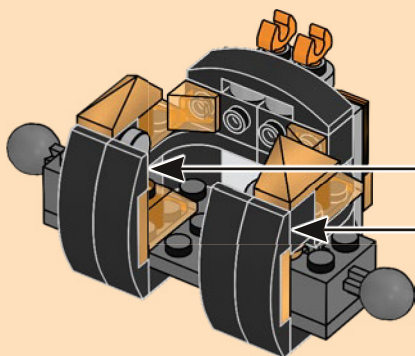
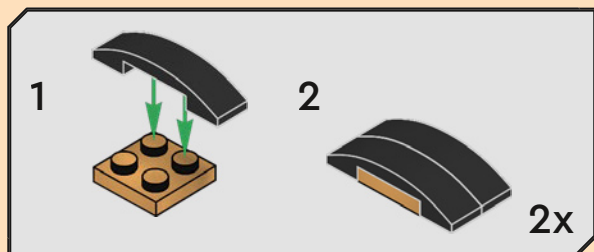



24

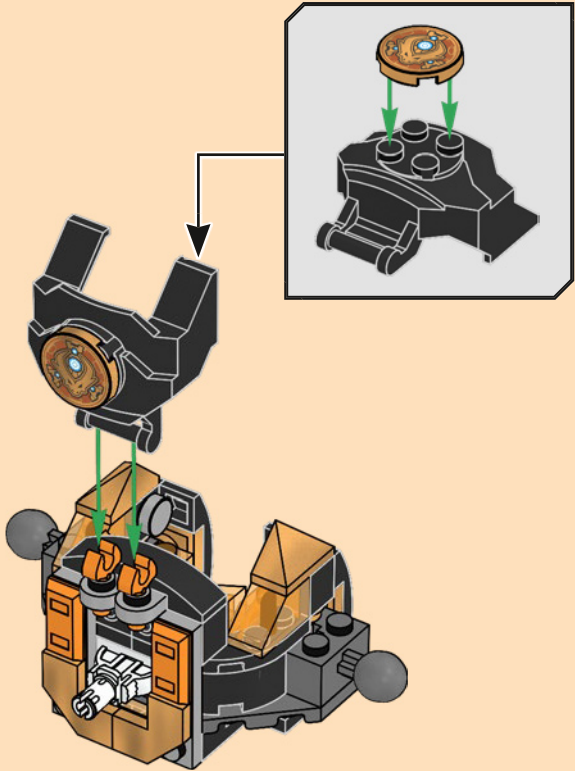

25

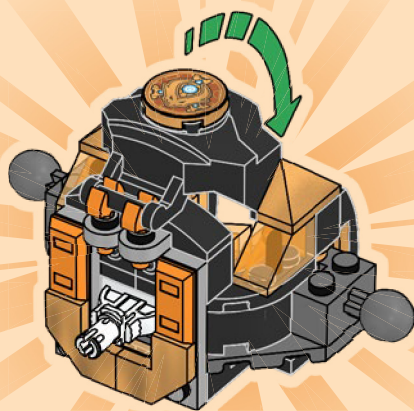

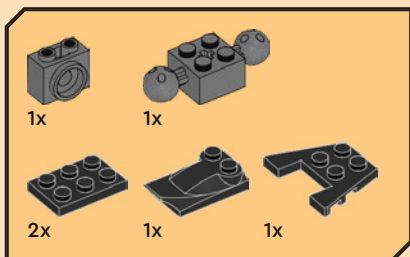

26

1

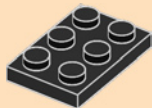

2

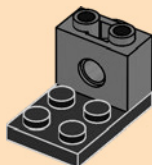

3

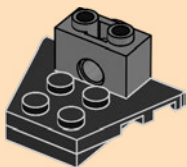

5

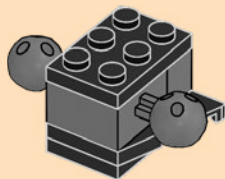

4

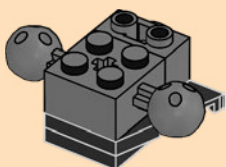

6

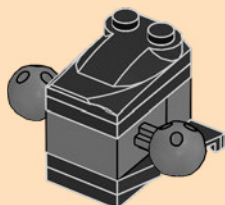

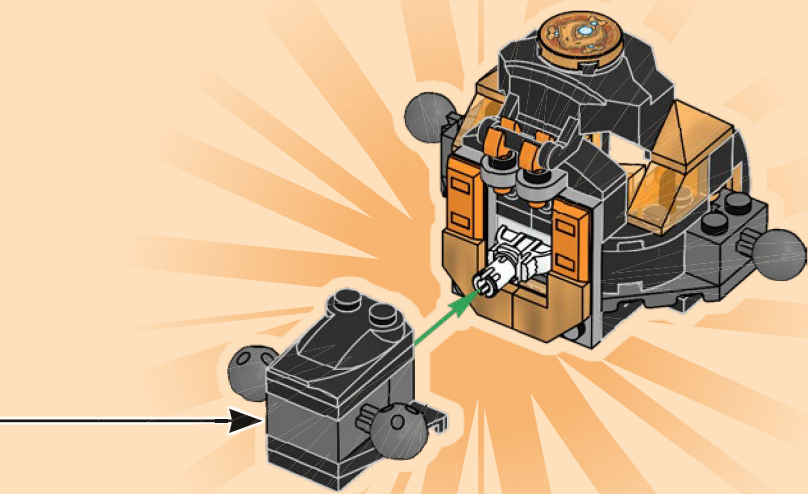



1x

27

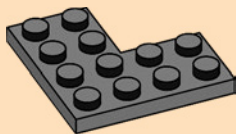

1x



1x

28

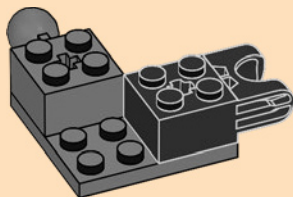



1x

29

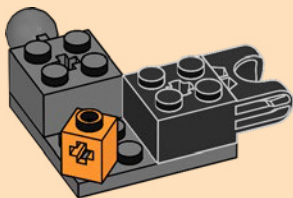

1x

30

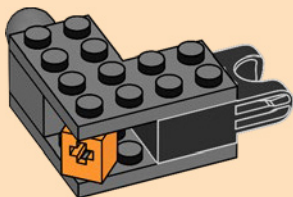



31

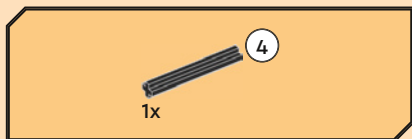
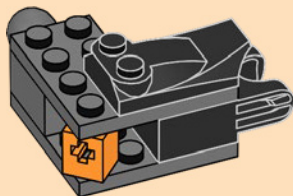

32

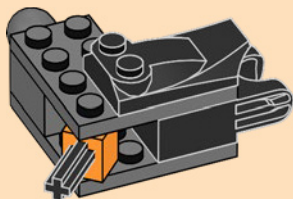

33

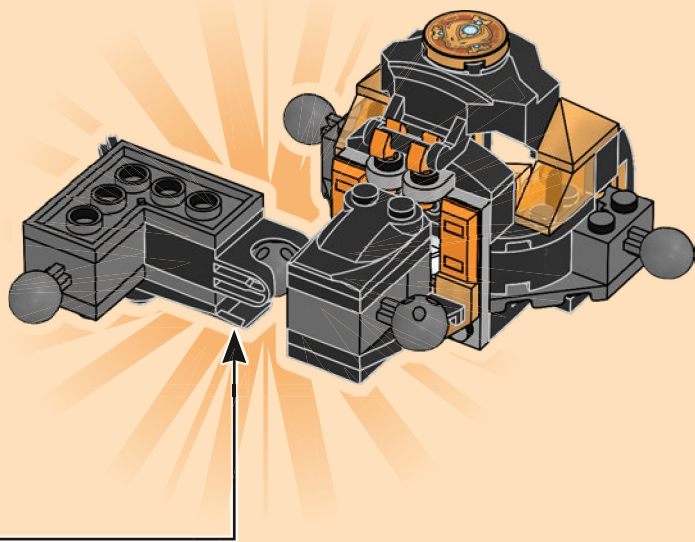

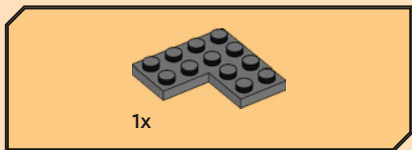

34

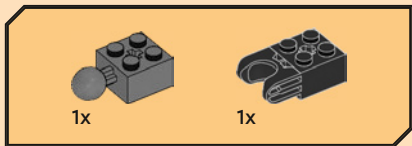

35

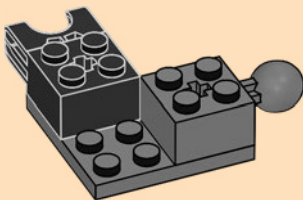



1x

36

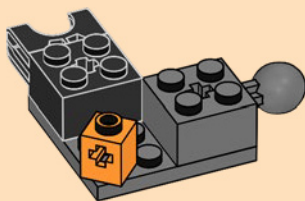

1x

37

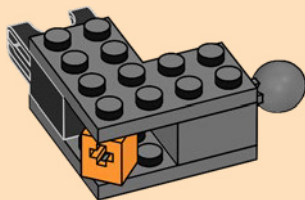

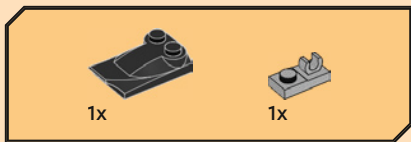

38

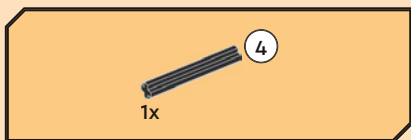
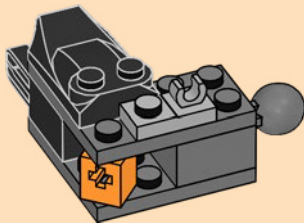

39

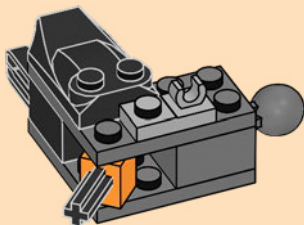

40

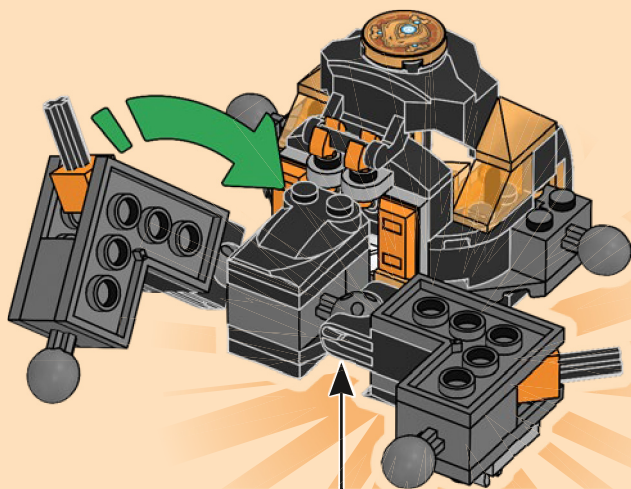

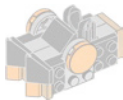

2x



1x

41



2x

42

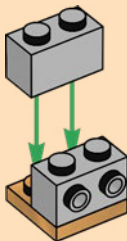

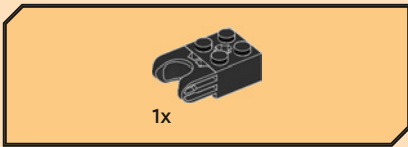

43

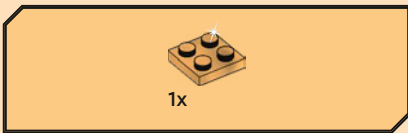
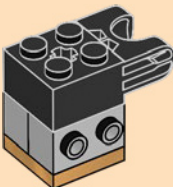

44



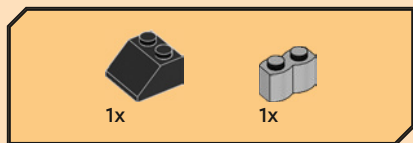

45

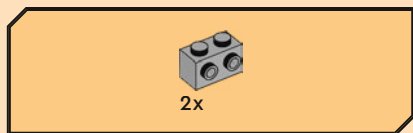
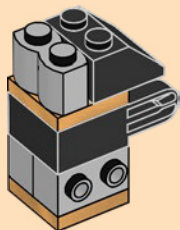

46

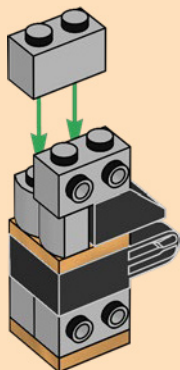



2x

47

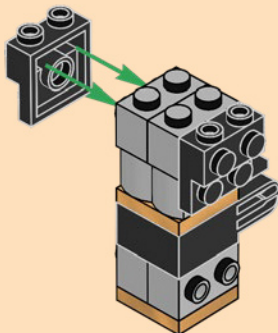

2x

48

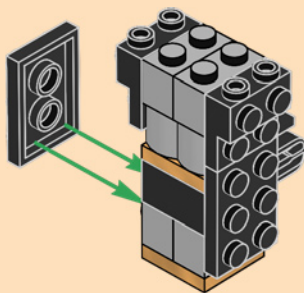



49

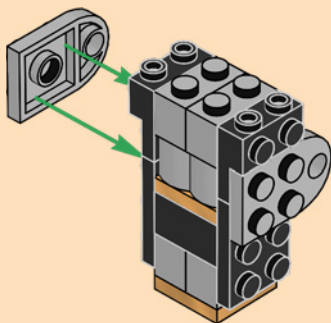

50

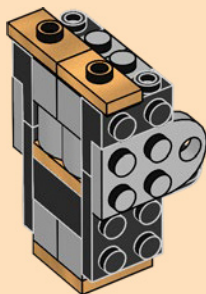



51

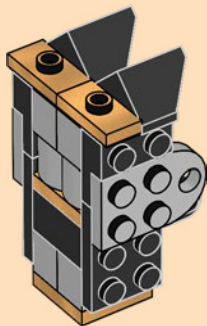

52

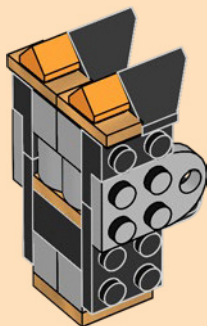



53

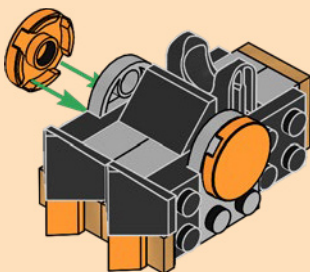

2x



54

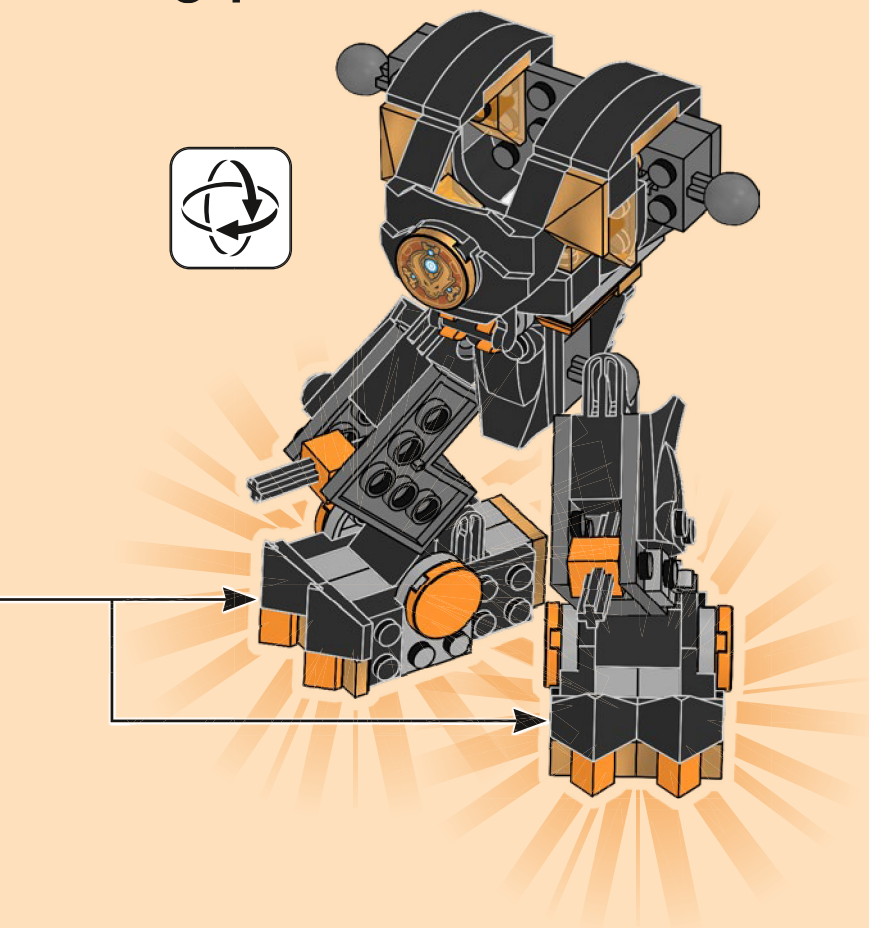



2x

55

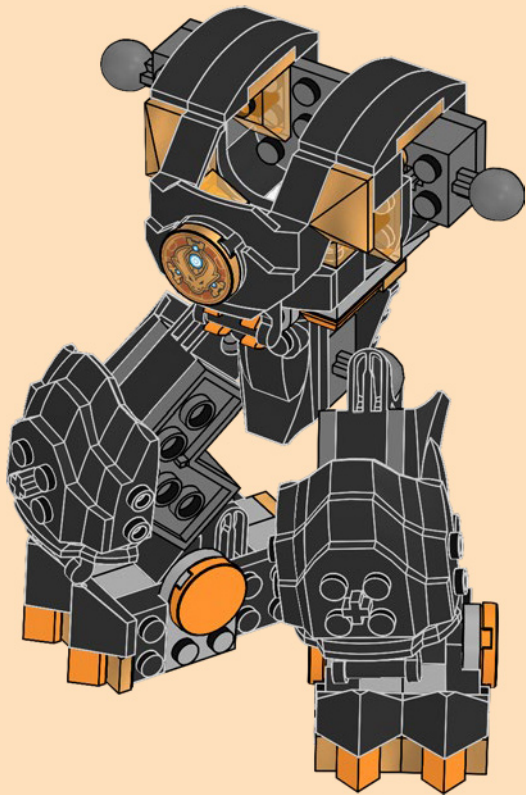



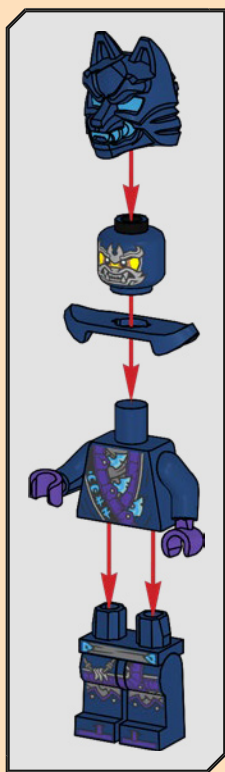

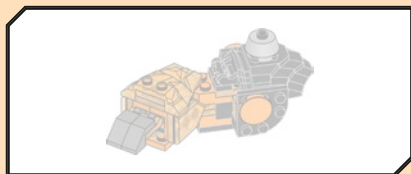

56

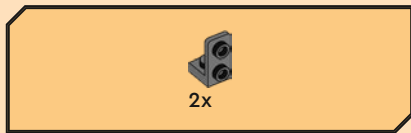
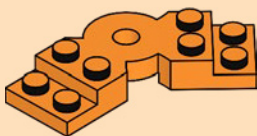

57

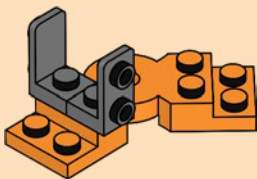

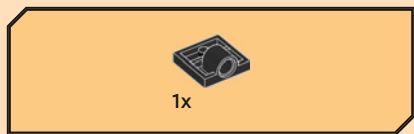

58

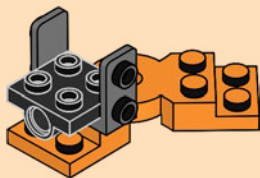

59

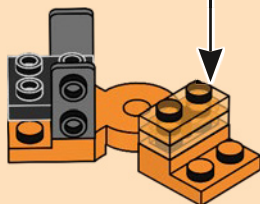
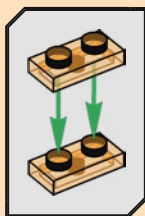



1x

60

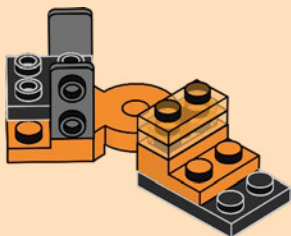

2x

61

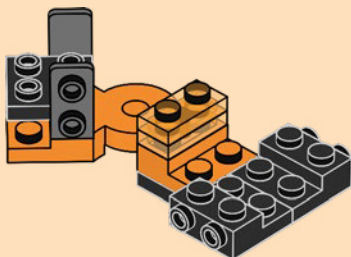



62

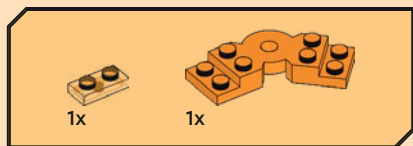
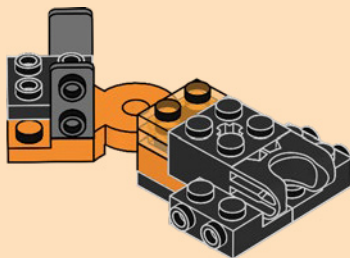

63

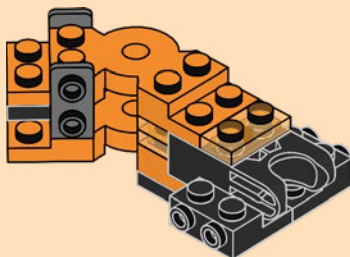

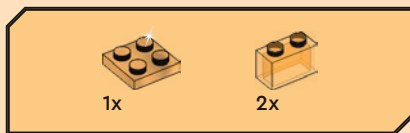

64

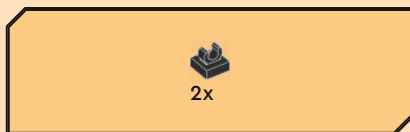
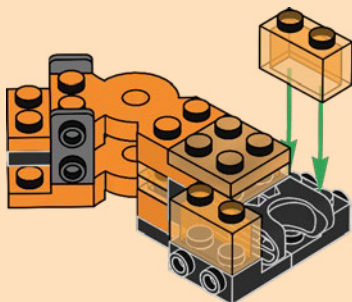

65

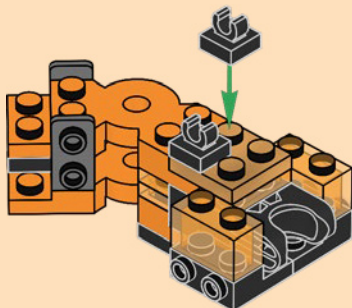

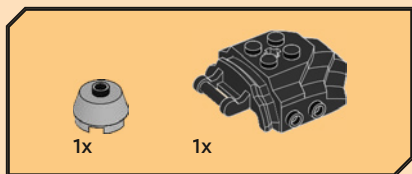

66

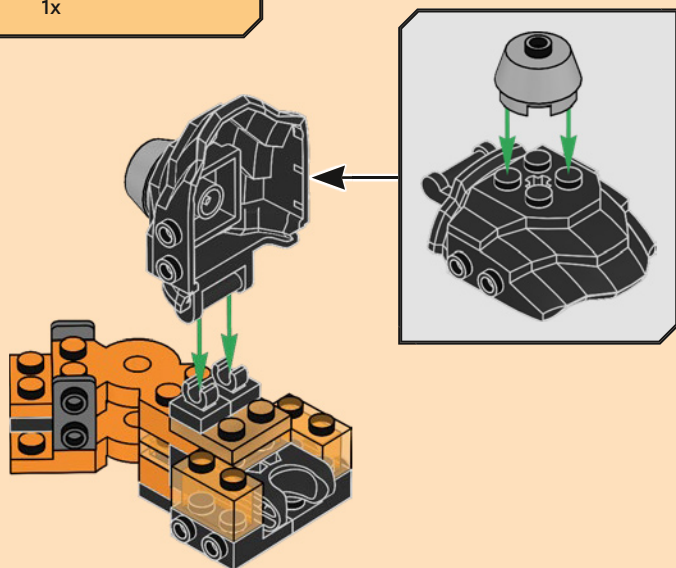

67

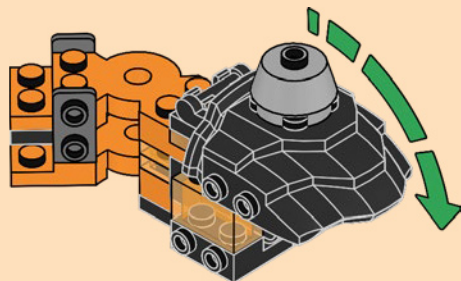

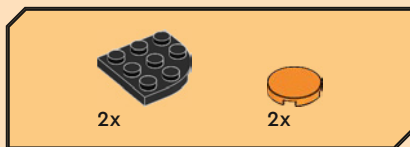

68

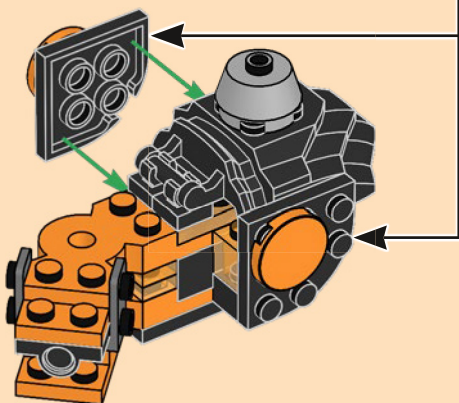
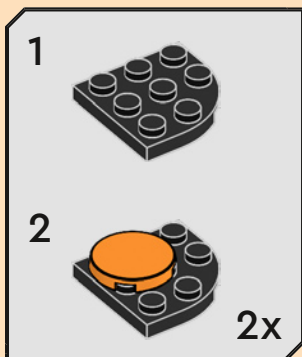



1x

69

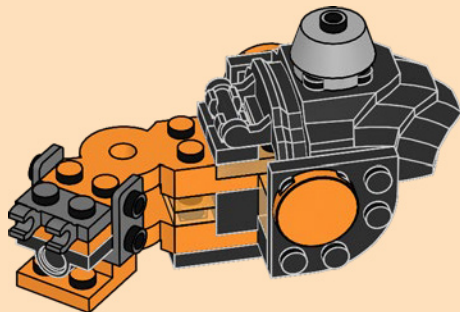

1x



2x

70

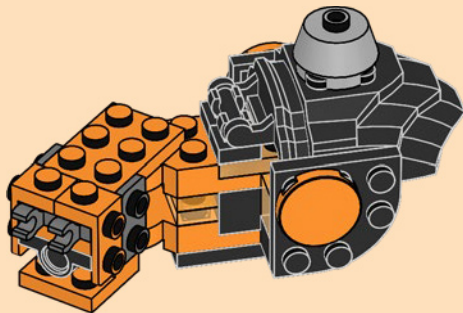

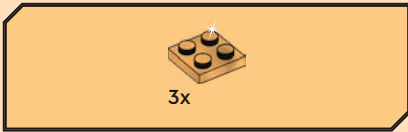

71

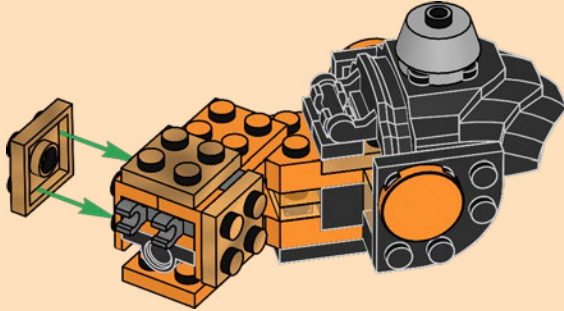

72

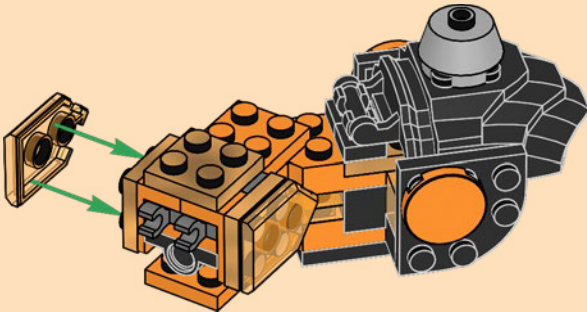

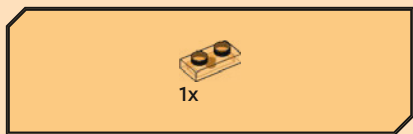

73

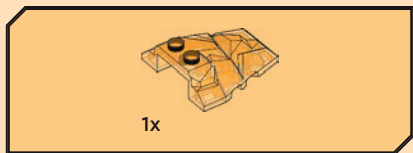
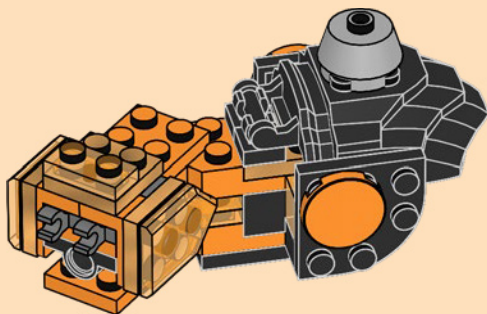

74

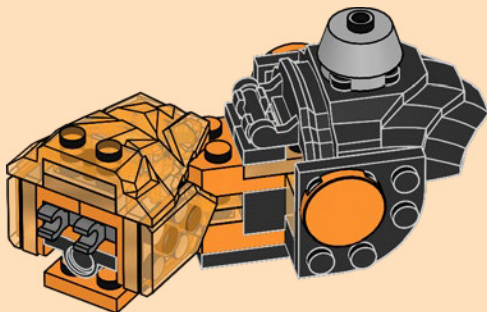

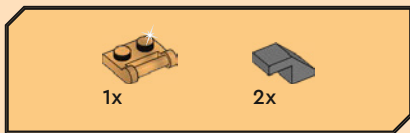

75

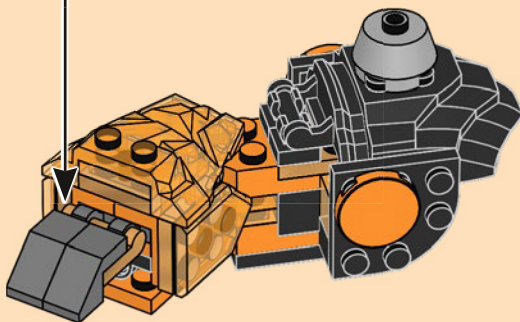
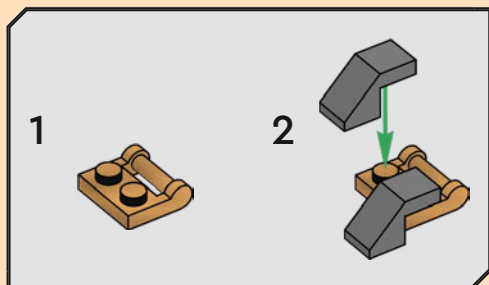

76

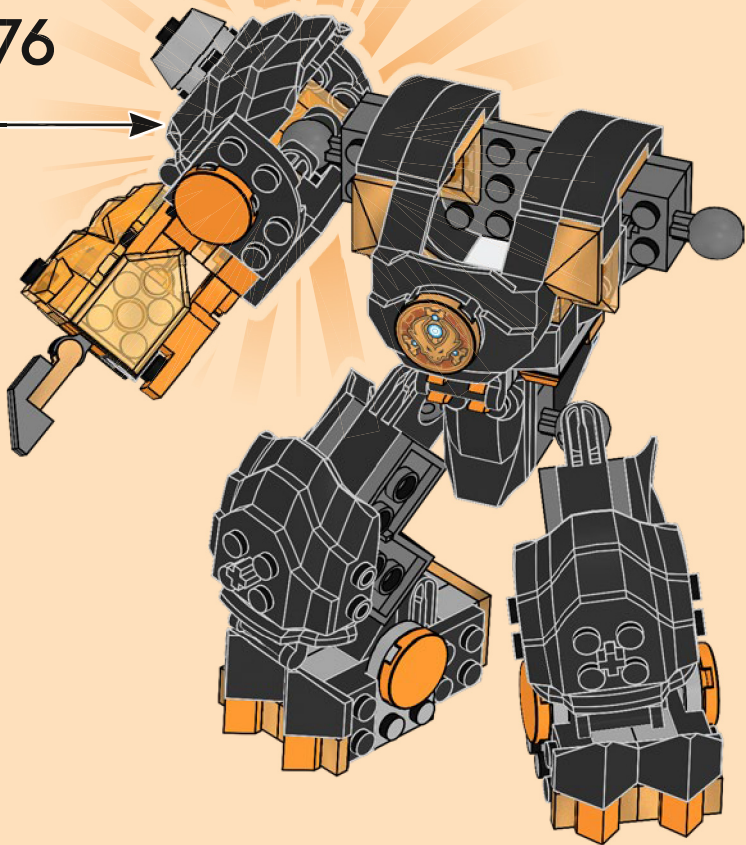

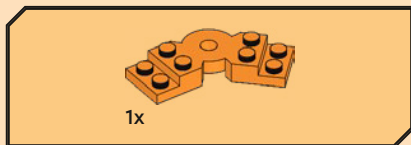
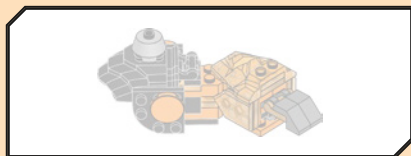

77

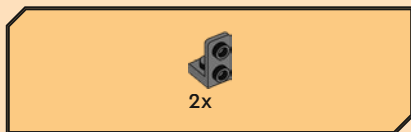
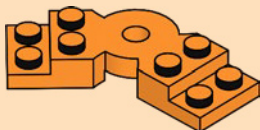

78

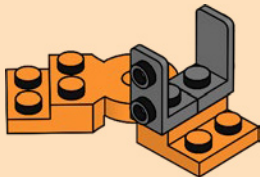



1x

79

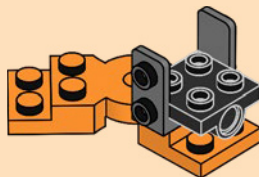

2x

80

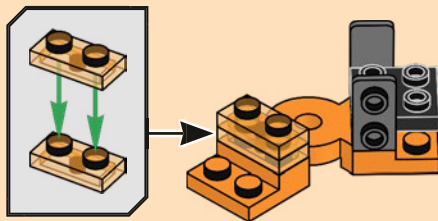

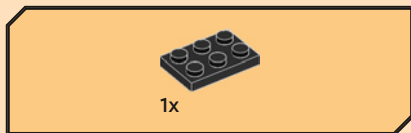

81

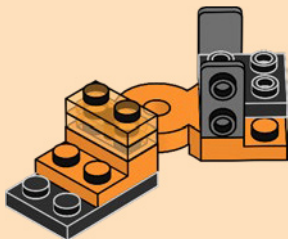

82

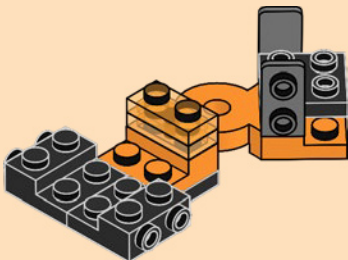



1x

83

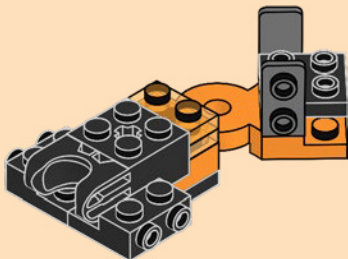

1x



1x

84

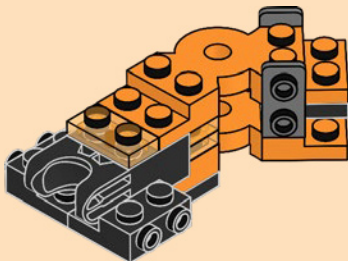

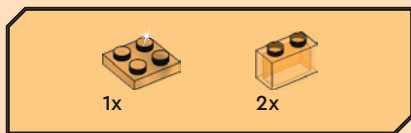

85

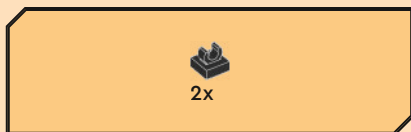
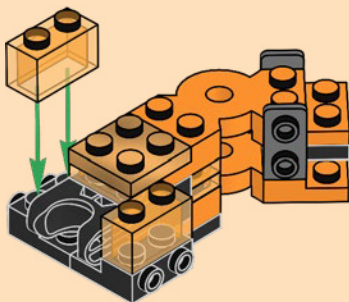

86

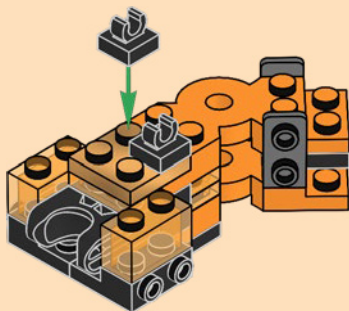

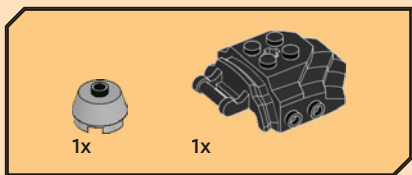

87

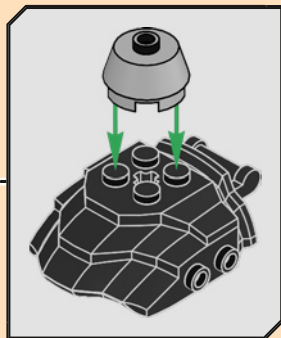
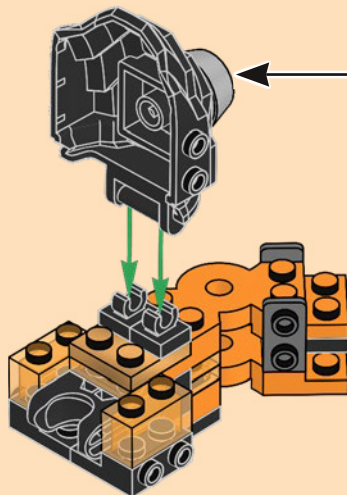

88

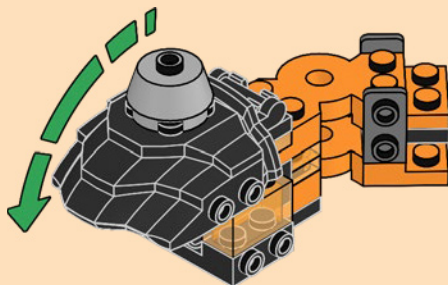



89

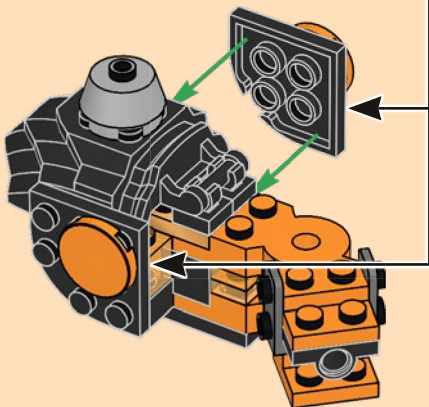
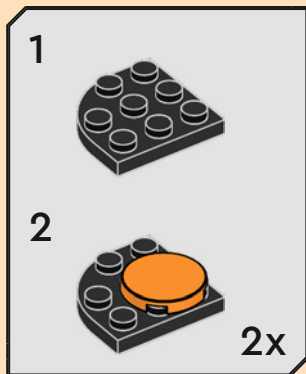



1x

90

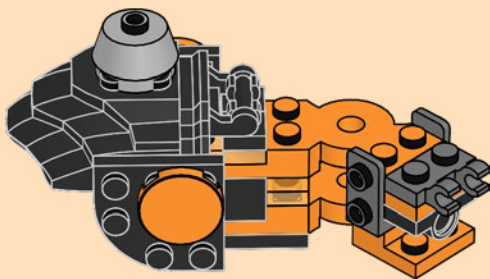

1x



2x

91

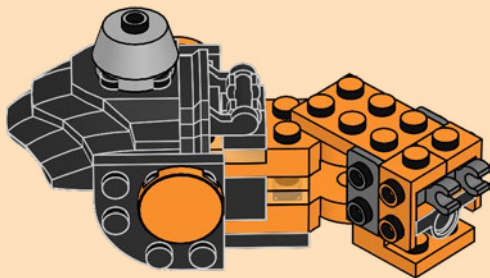

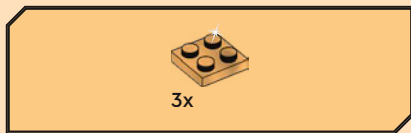

92

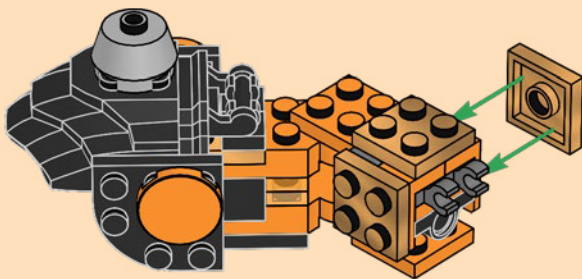

93

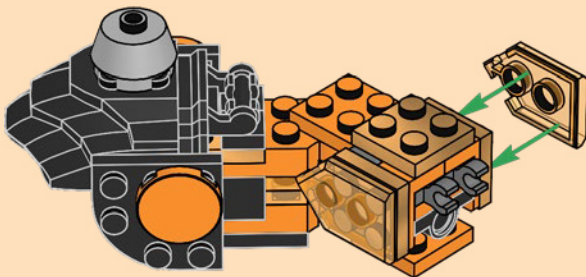

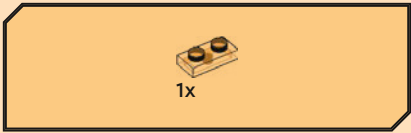

94

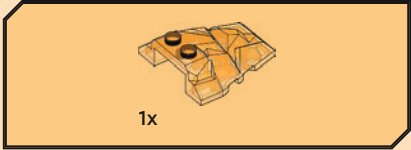
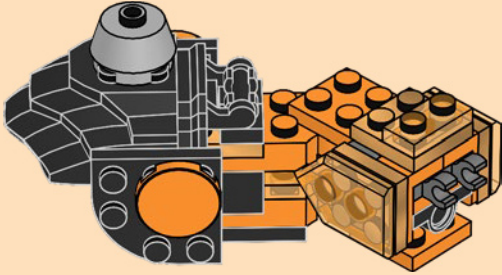

95

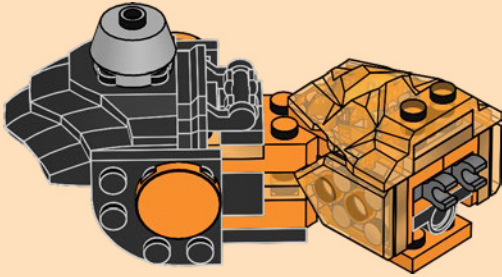

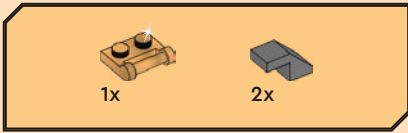

96

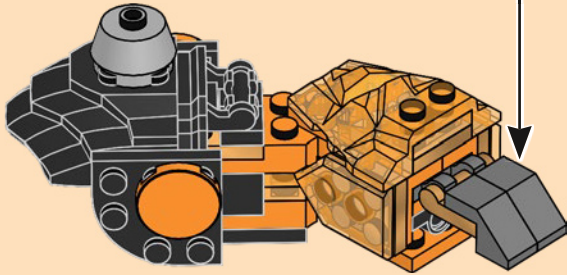
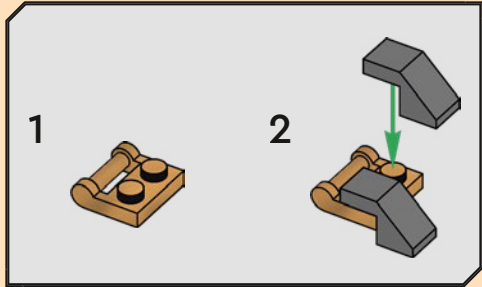

97

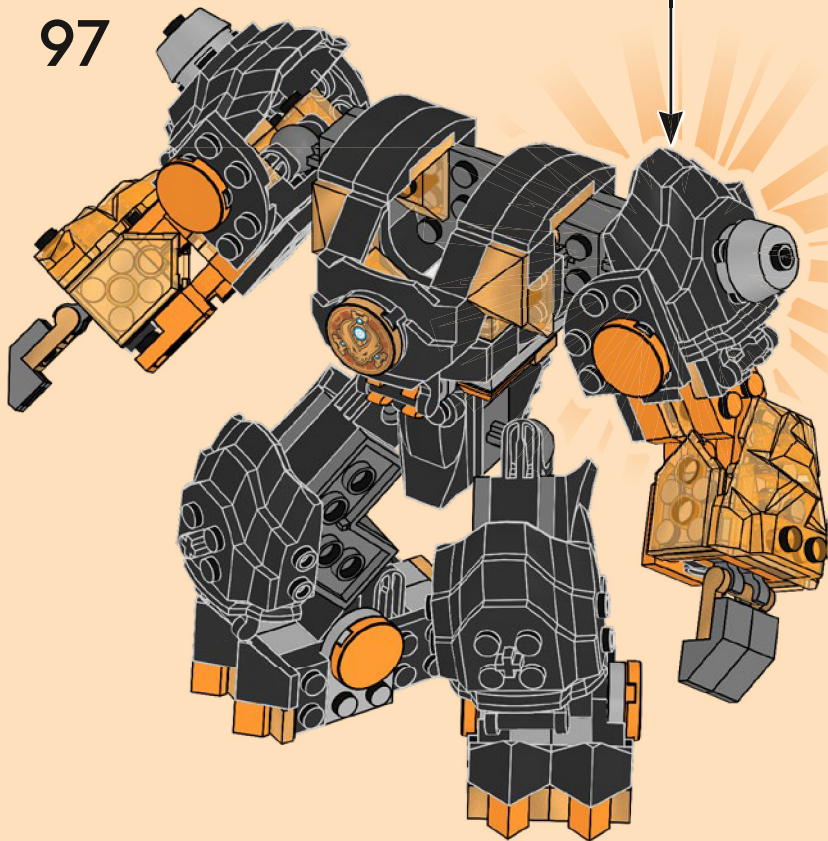

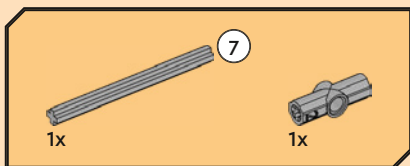
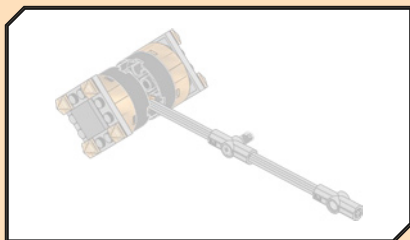

98

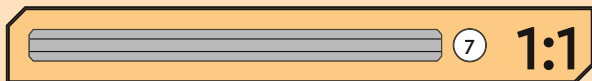
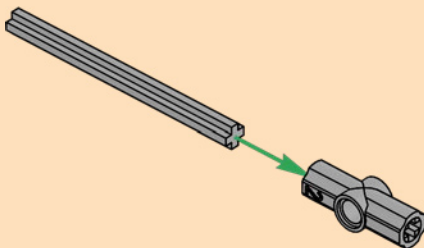

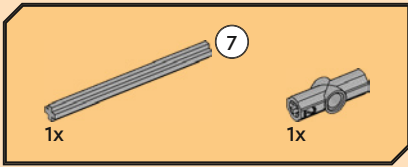

99

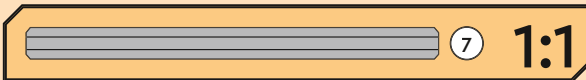
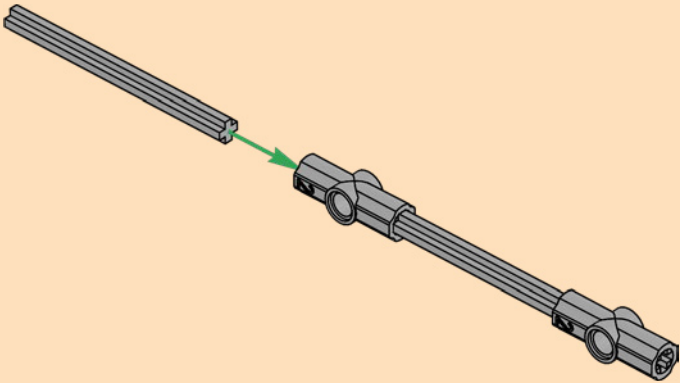

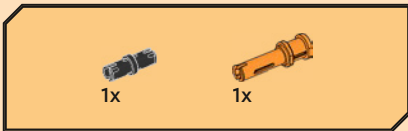

100

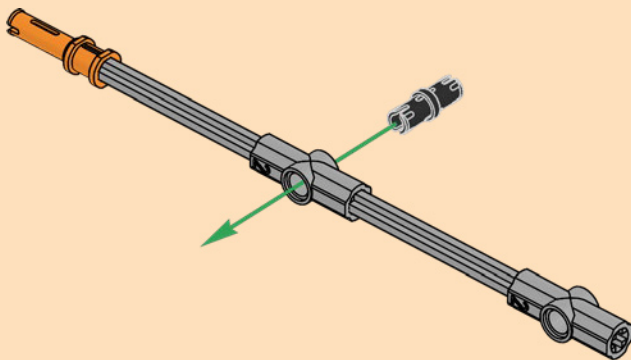



1x

101

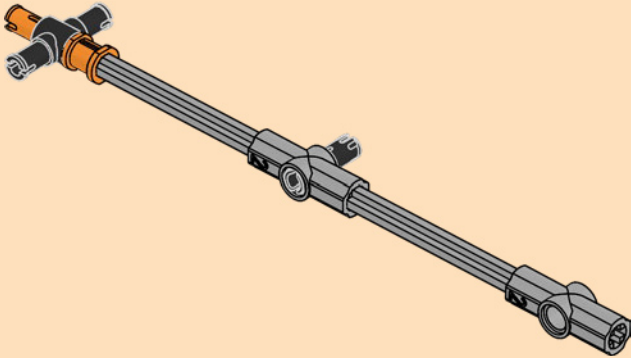

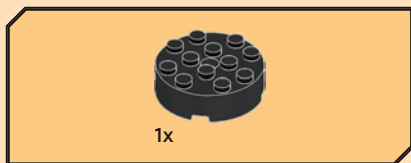
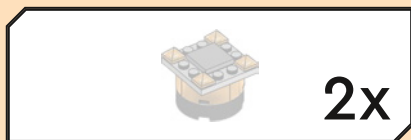

102

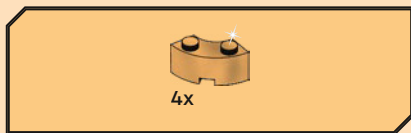

103

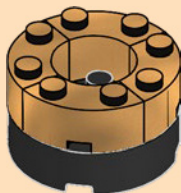

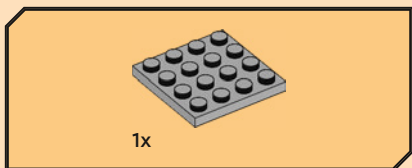

104

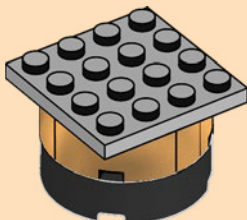

105

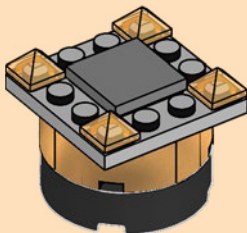

2x

106

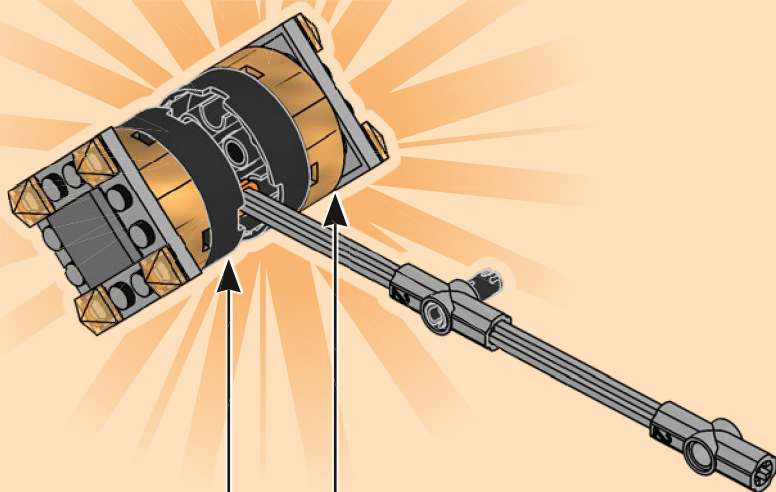

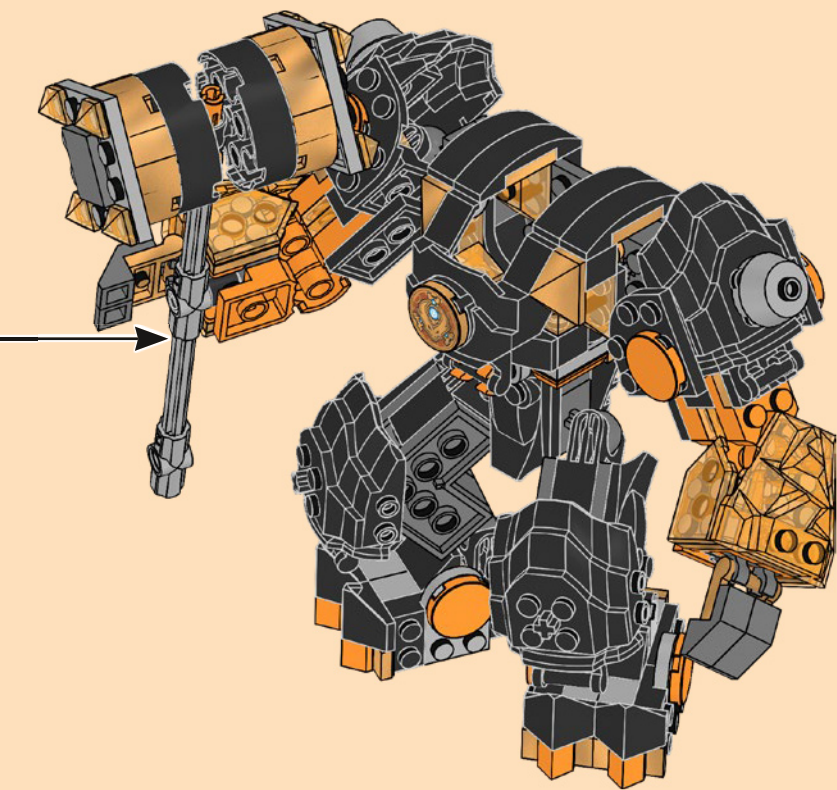

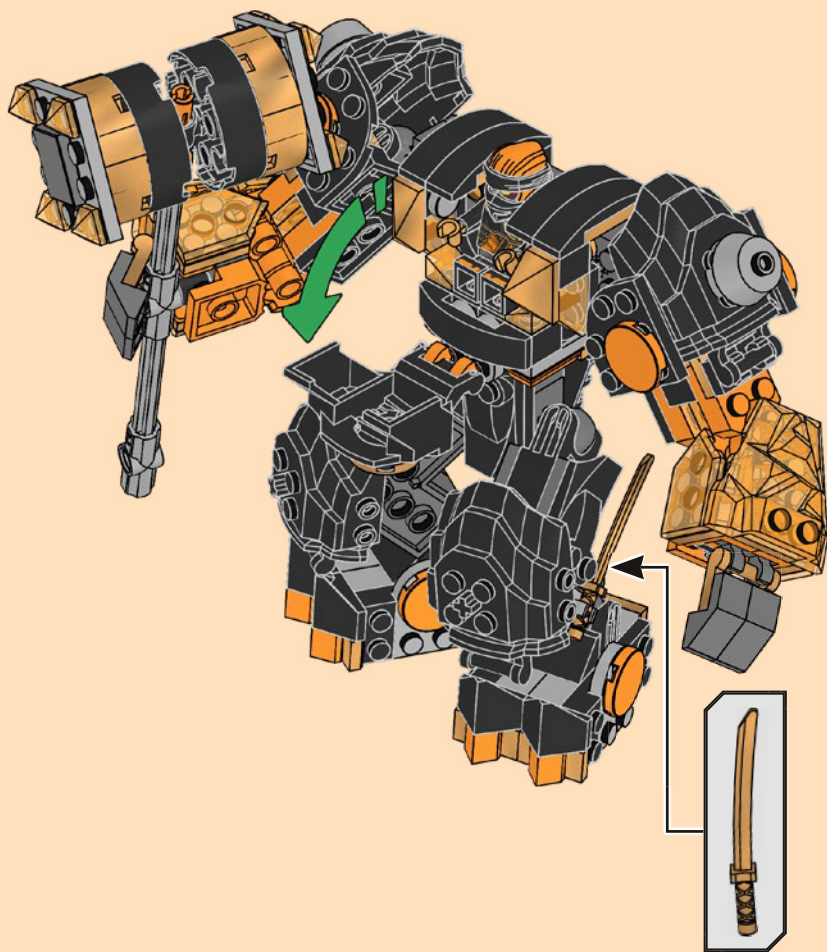





CUSTOMISE YOUR MECH

Customise Your Mech
Personalisiere deinen Mech
Personalise ton robot
Personalizza il tuo mech
Personaliza tu meca
Personaliza o Teu Robô
定制你的机甲
Personalizuj swojego mecha

Uprav si svého robota
Uprav si svojho robota
Tedd egyediév robotodat!
Personalizează-ți robotul
Персоналізуйте свого робота
Pielāgo savu robotu
Kohanda oma robotit
Pritaikykite savo robotą

71806



71807



71808

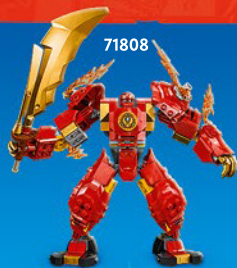

A



B



C



1x
6366229

4x
6335388

2x
6187572

1x
6279875

2x
4253815

1x
6464356

4x
4220539

2x
6061032

2x
303926



2x
4567436

12x
6469445

1x
6469027

4x
4227392

8x
302126

2x
370526

3x
4285883

5x
4613153

6x
6360825

2x
4558957

1x
6170529

2x
6325190

1x
6466691

4x
6466647

2x
6439042

2x
6339309

4x
6223631

4x
6442363

1x
6468747

8x
6092770

2x
6149656

1x
6347790

2x
4125278

1x
4158355

4x
6372446

1x
6464352

1x
6468746

1x
6464354

1x
6315048

1x
6469272

2x
6245265

8x
6250584

4x
6219825

10x
6240217

4x
6466832

4x
6382017

2x
6466641

4

2x
6284071

2x
6248890

2x
6028324

2x
4550325

1x
6326078

8x
6015344

2x
6346487

4x
4211419

2x
4211445

2x
4243797

2x
4211805

4x
6336390

1x
6398662

4x
6168776

2x
6350292

2x
4211055

4x
4497253

1x
6065816

4x
4539429

1x
6311001

4x
4523159

2x
6075079

1x
6467216

4x
6092594

2x
4585493

2x
6388241

8x
6107743

1x
6116596

14x
6347982

1x
6434450

1x
6472887

1x
6461579



LEGO.com/service

YOU COULD

WIN



Scan this QR code or go to
LEGO.COM/PRODUCTFEEDBACK
and give us your short feedback
about this LEGO® set for a chance
to win a cool LEGO prize.

Terms and Conditions apply*



EN: YOU COULD WIN. Terms and Conditions apply* **DE: Du könntest GEWINNEN.** Es gelten die Teilnahmebedingungen* **FR: Tu pourrais GAGNER.** Des conditions s'appliquent* **IT: Potresti VINCERE tu.** Termini e condizioni sono applicabili* **ES: Puedes GANAR.** Aplican términos y condiciones* **PT: Poderá GANHAR.** Aplicam-se termos e condições* **ZH: 轻松获奖. 条款和条件适用*** **PL: Szansa na WYGRANĄ.** Obowiązują warunki korzystania* **CS: Máte šanci VYHRÁT.** Platí všeobecné smluvní podmínky* **SK: Máte šancu VYHRAŤ.** Platia všeobecné zmluvné podmienky* **HU: TE IS NYERHETSZ.** Felhasználási feltételek érvényesek* **RO: Ai putea CÂȘTIGA.** Se aplică termenii și condiții* **BG: Можете да СПЕЧЕЛИТЕ.** Има определени правила и условия* **LV: Tu vari LAIMĒT.** Ir spēkā noteikumi un nosacījumi.* **ET: Sul on võimalus VÕITA.** Kehtivad tingimused* **LT: Jūs galite LAIMĖTI.** Taikomos sąlygos*

*[LEGO.com/productfeedback-terms](https://www.lego.com/productfeedback-terms)

LEGO, the LEGO logo and NINJAGO are trademarks of the LEGO Group. ©2024 The LEGO Group.

6497699