



Friends

42610



LEGO® Builder



LEGO.com/sustainable-packaging



 ^{FR} **DONNEZ**
OU
RECYCLEZ

 OU  OU 

ASSOCIATION MAGASIN DÉCHÈTERIE

Adresses sur quefairedemesdechets.fr

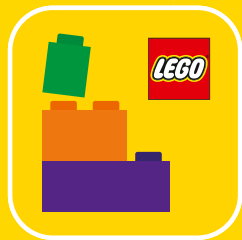

BUILDER



Apple and the Apple logo are trademarks of Apple Inc., registered in the U.S. and other countries and regions. App Store is a service mark of Apple Inc. Google Play and the Google Play logo are trademarks of Google LLC. Tencent and the Tencent logo are trademarks of Tencent Inc.

Q LEGO.com/devicecheck

EN Ask parents' permission before going online | DE Eltern um Erlaubnis bitten, bevor du online gehst | FR Demande l'autorisation d'un parent avant d'aller en ligne | IT Chiedi il permesso ai tuoi genitori prima di andare online | ES Pídeles permiso a tus papás antes de conectarte a Internet | PT Pede autorização aos pais antes de acederes online | ZH 上网前应先征得父母的同意 | PL Poproś rodziców o zgodę, zanim wejdiesz do Internetu | CS Než půjdeš na internet, požádej rodiče o svolení | SK Skôr než pôjdeš na internet, vypýtaj si povolenie od rodičov | HU Kérj szülői engedélyt, mielőtt online csatlakoznál! | RO Cere permisiunea părinților înainte de a te conecta online | BG Поискайте разрешение от родител, преди да влезете онлайн | LV Pirms došanās tiešsaistē palūdz atļauju vecākiem | ET Enne Interneti kasutamist küsi vanematelt luba | LT Prieš prisijungdami prie interneto, atsiklauskite tėvų



LIANN

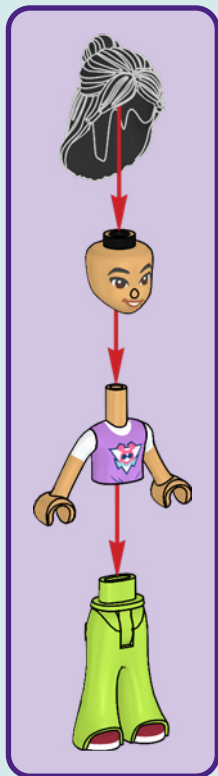



POPCORN

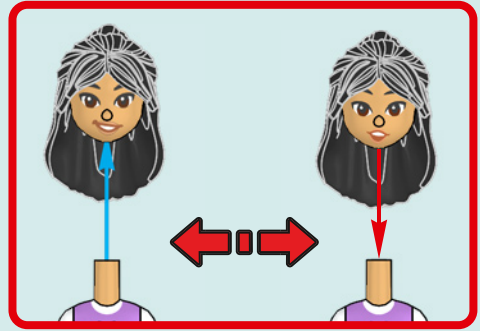

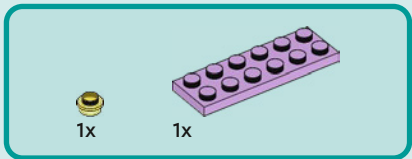
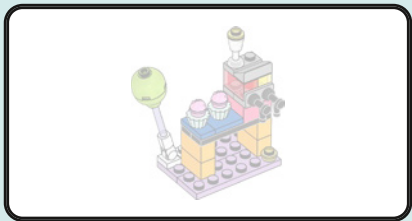

1

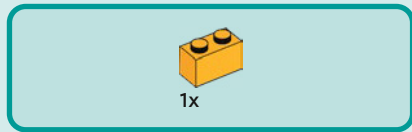
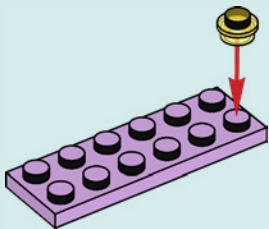

2

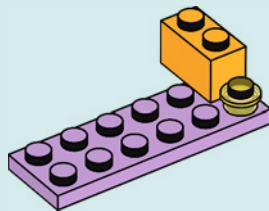

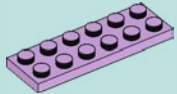

1x

3

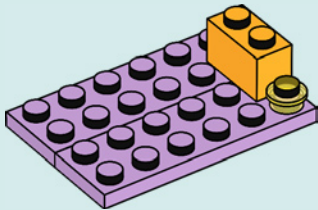

1x

4

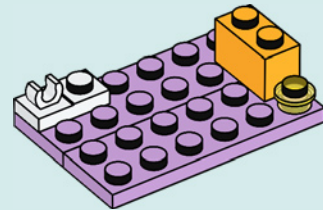



1x

5

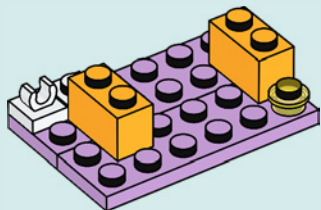

2x

6

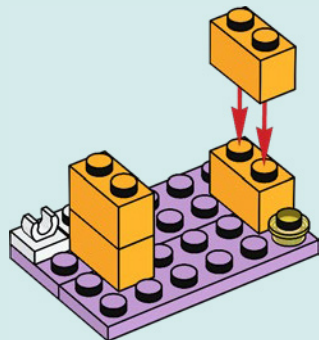



2x

7

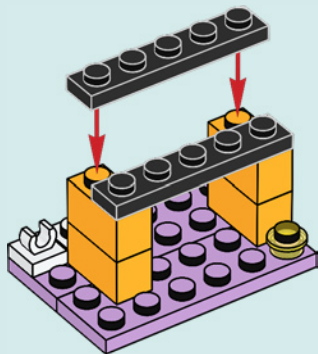

1x



1x



1x

8

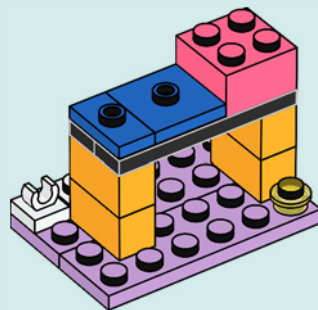



1x



1x

9

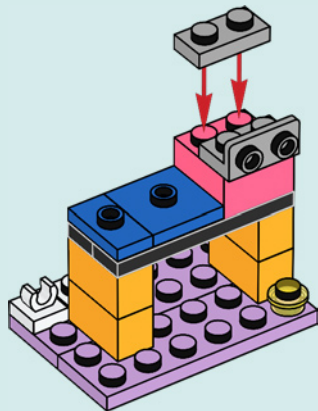

1x



1x

10

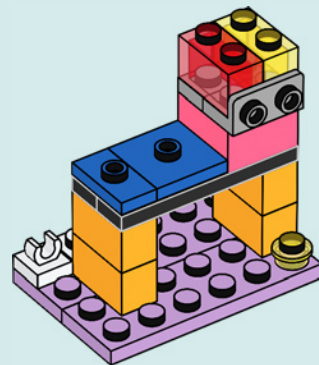



2x

11

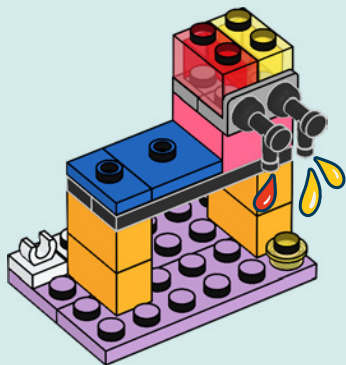

1x



1x

12

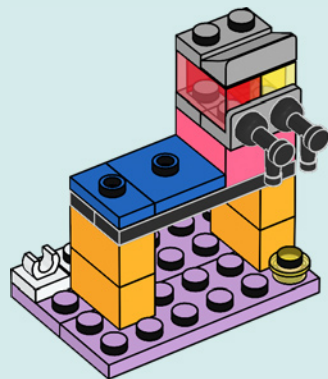



2x



2x

13

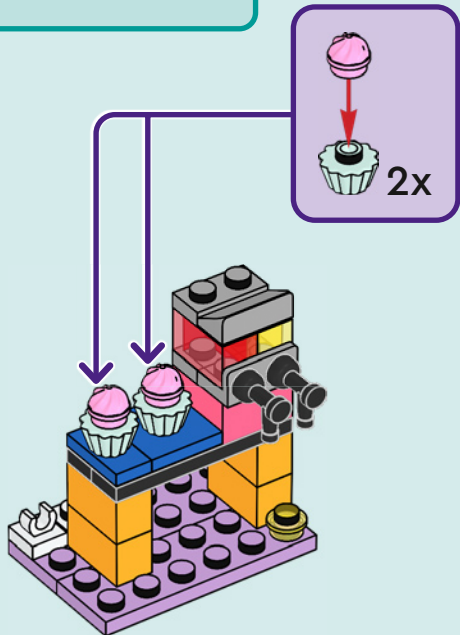

1x



1x

14

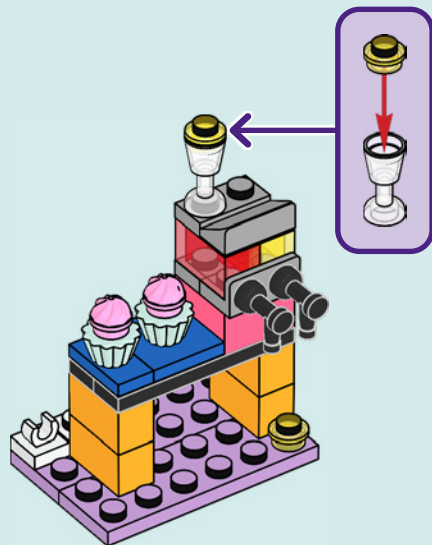

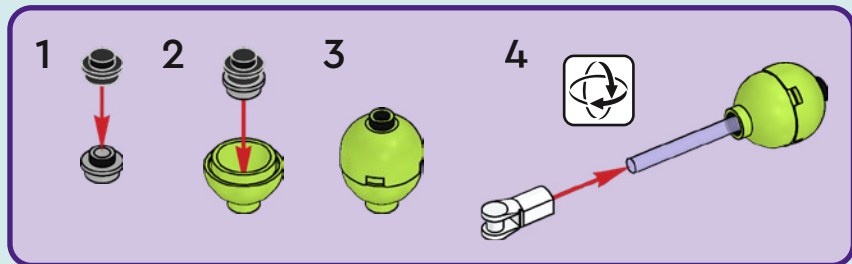
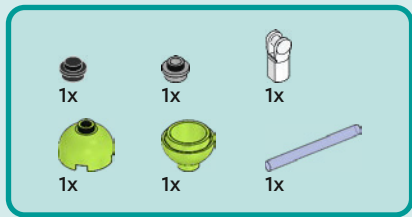

15

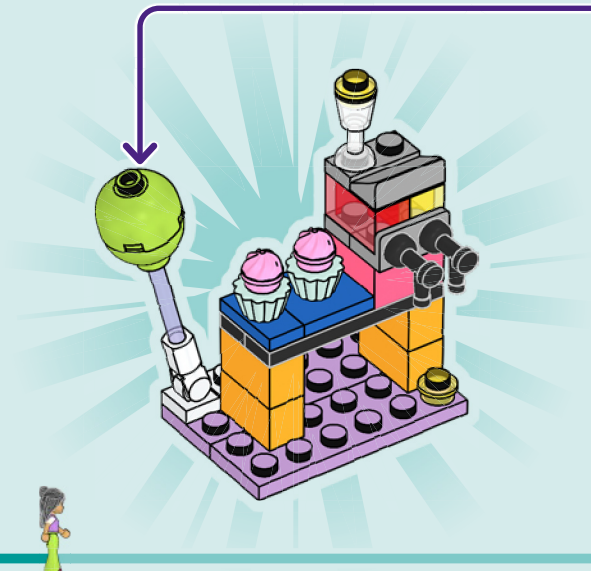

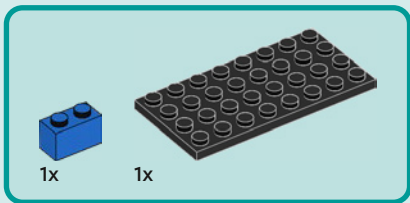
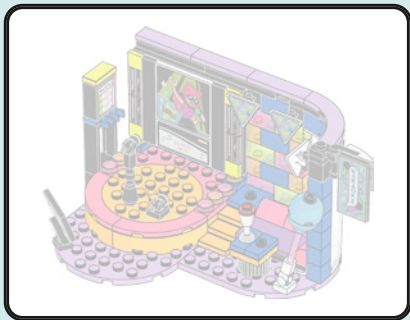

1

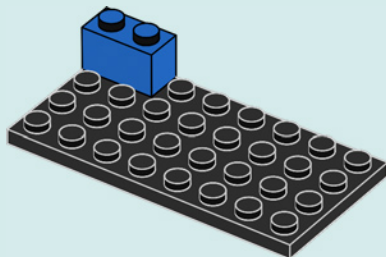



1x



1x

2

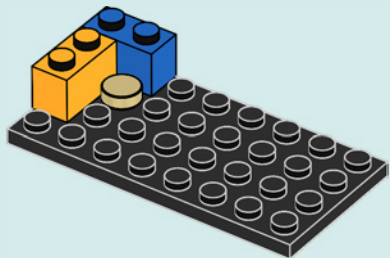

2x



1x

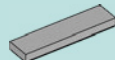

1x

3

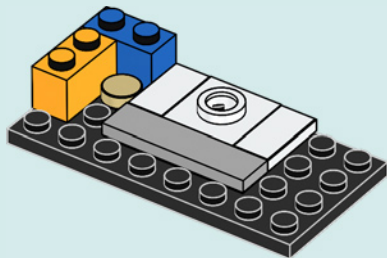

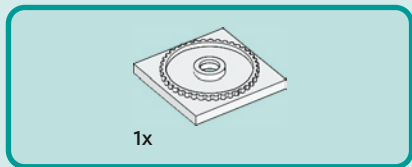

4

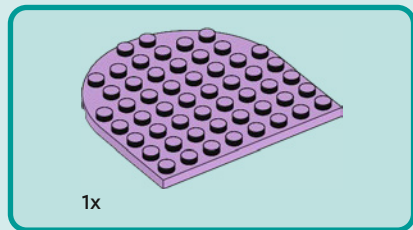
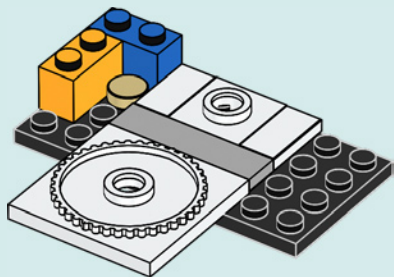

5

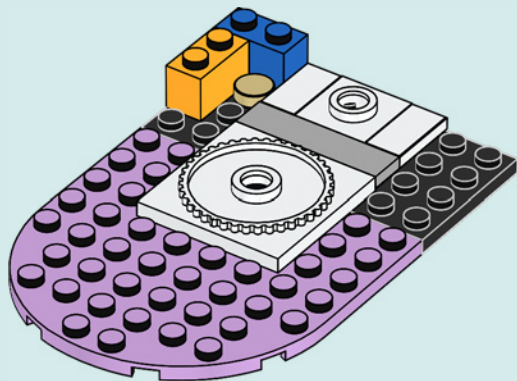

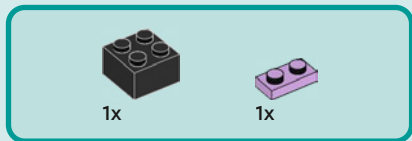

6

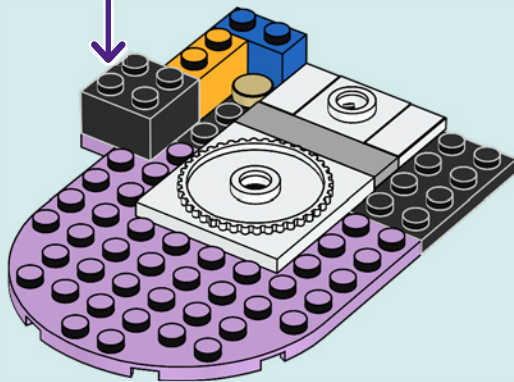
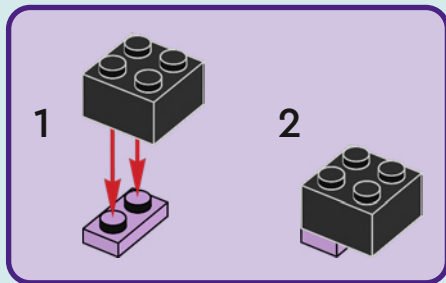

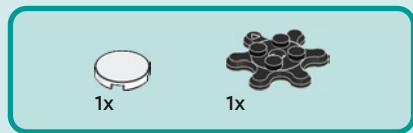

7

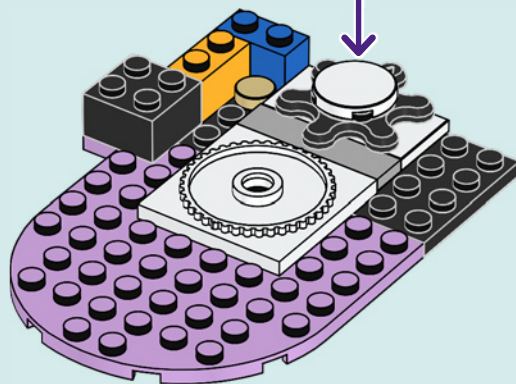
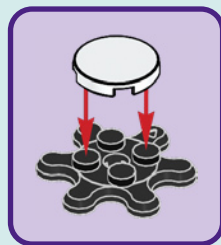

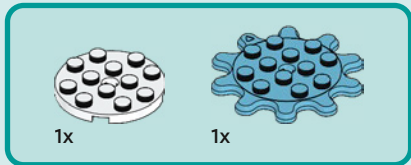

8

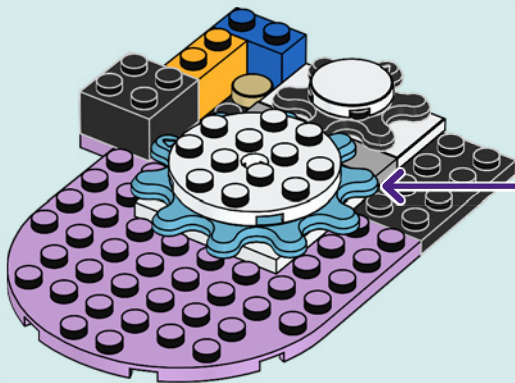
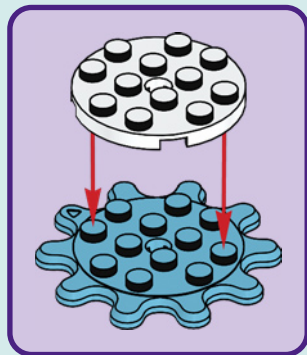

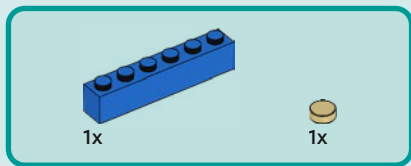

9

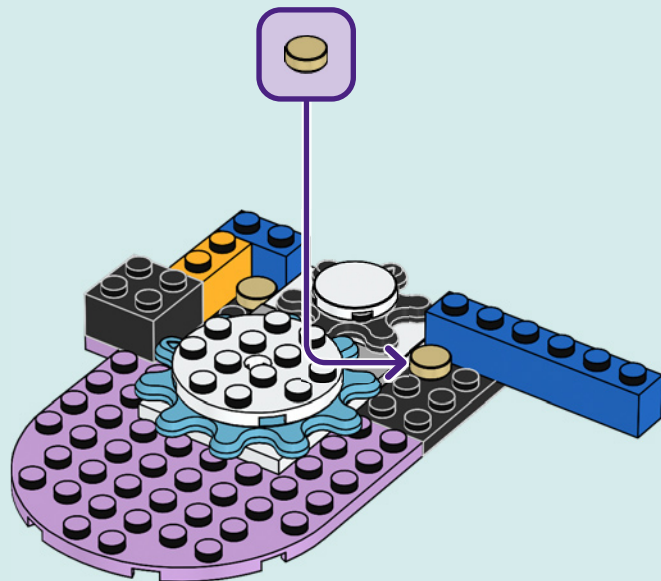

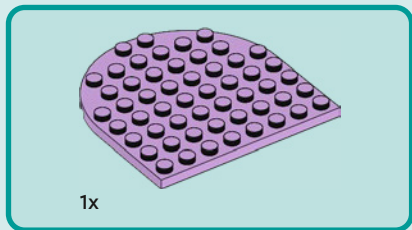

10

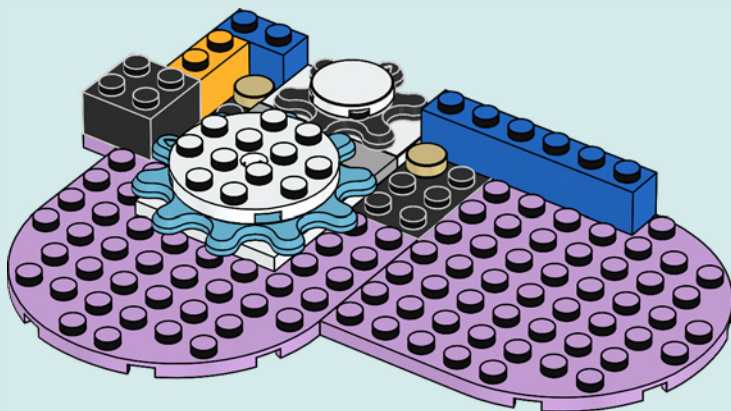



2x

11

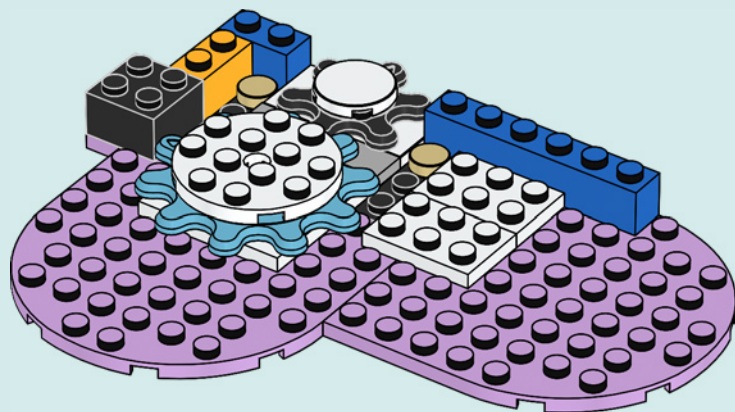



2x

12

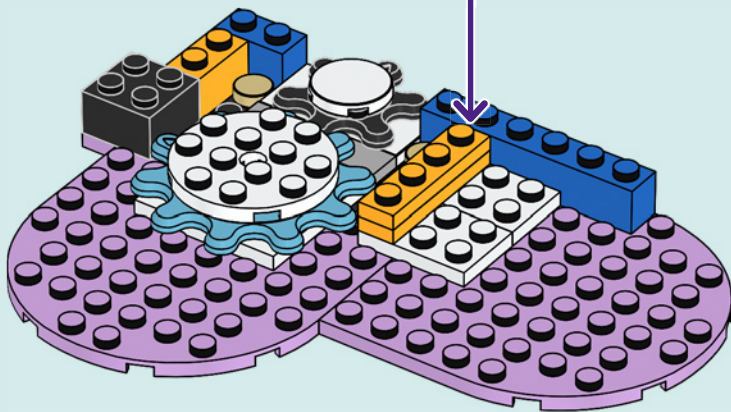
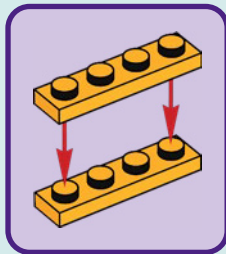



2x



1x

13

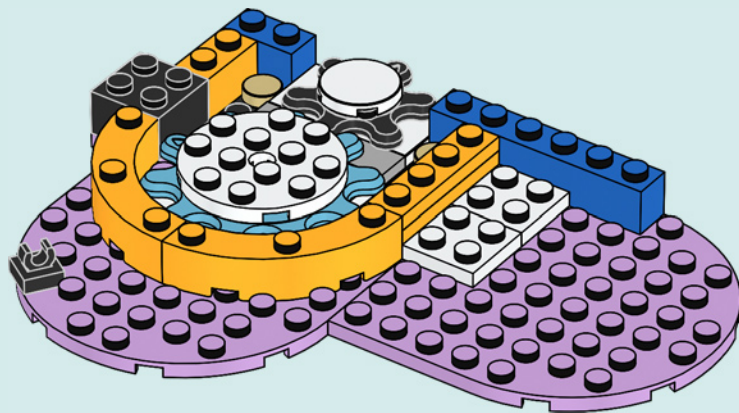

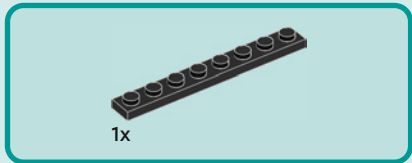

14

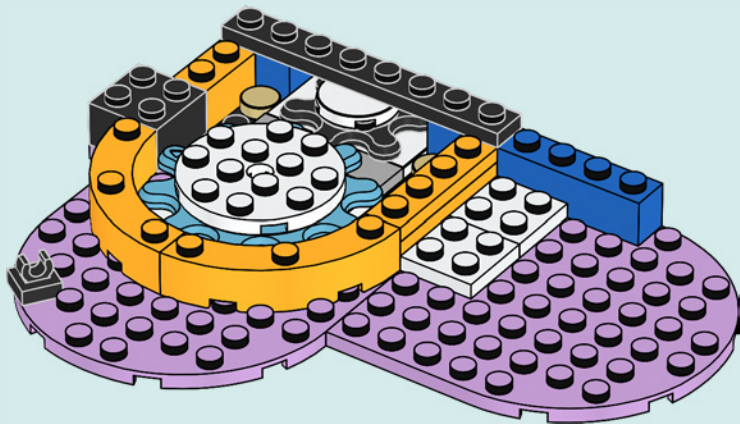



2x

15

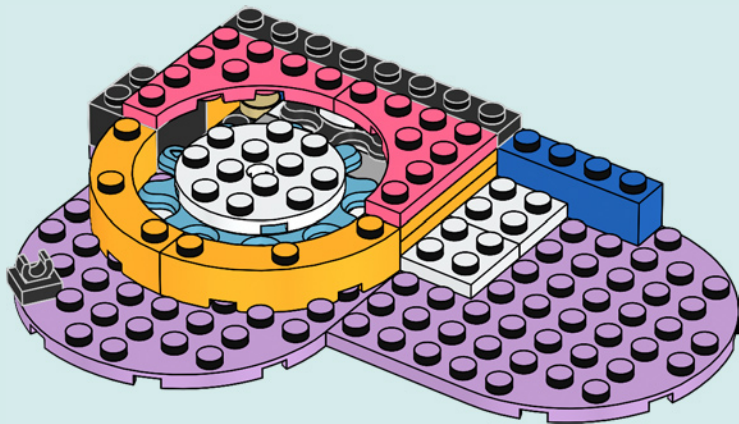

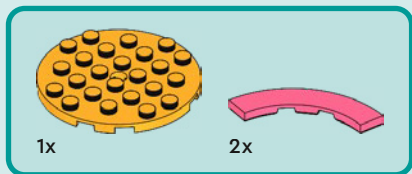

16

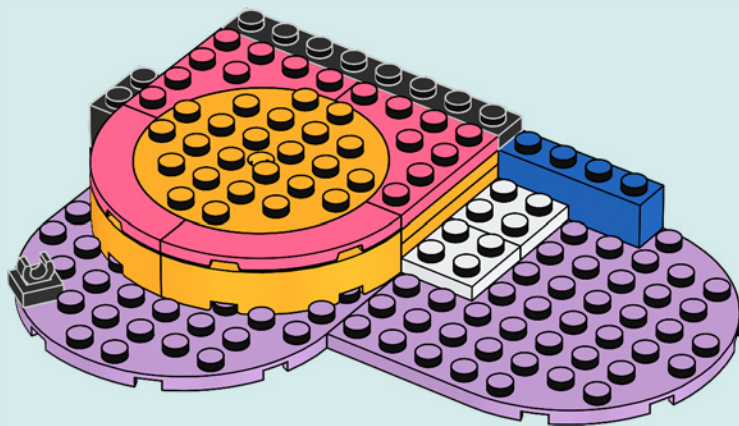

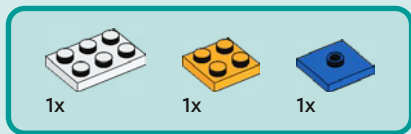

17

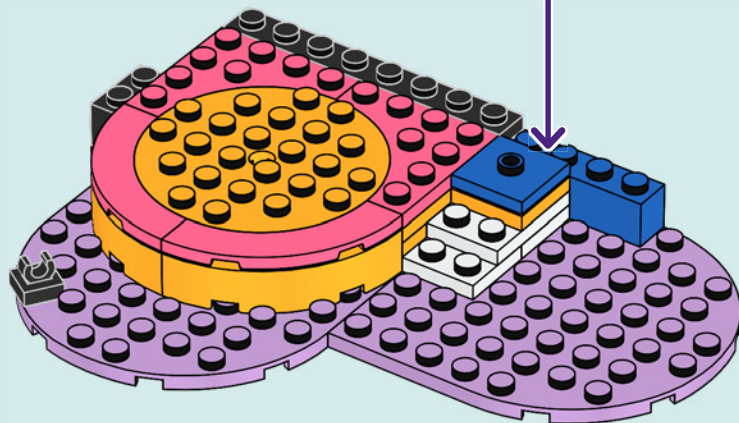
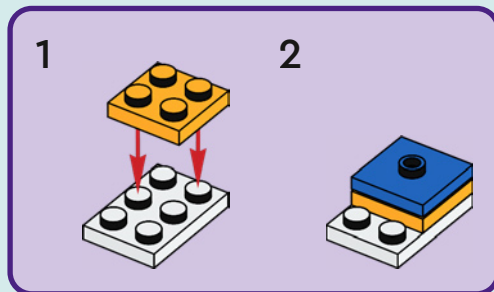



3x

18

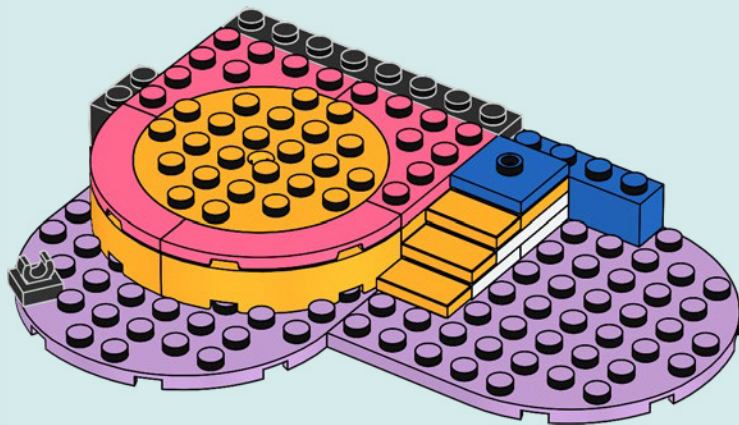

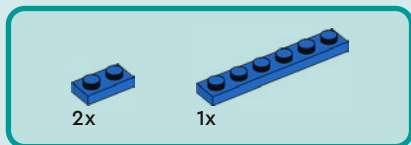

19

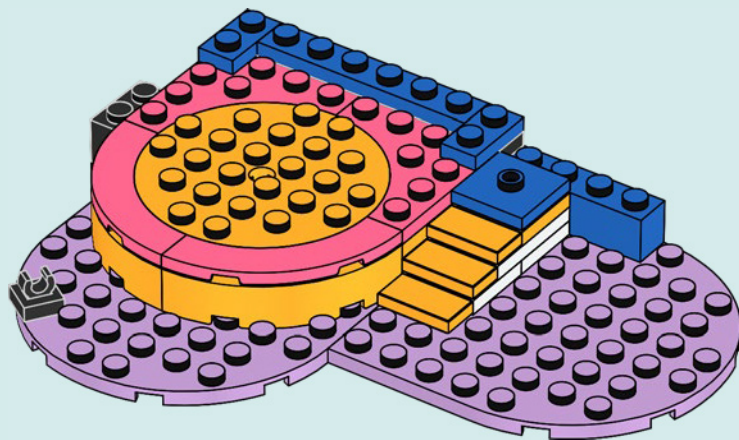

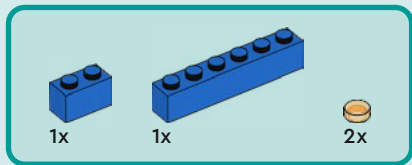

20

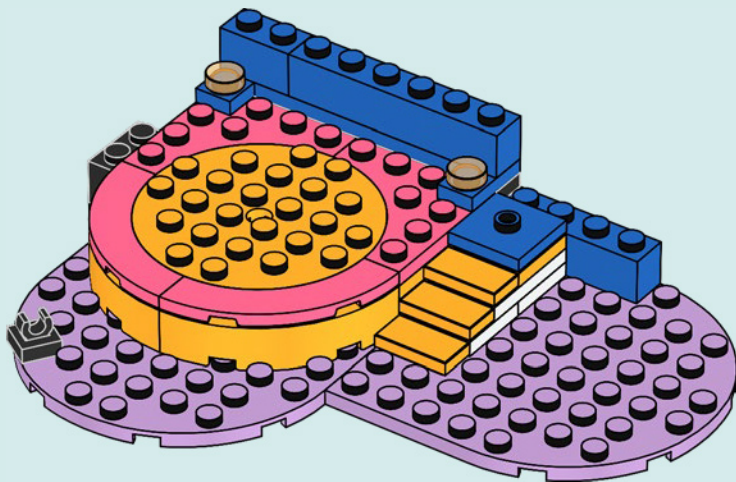



4x



2x

21

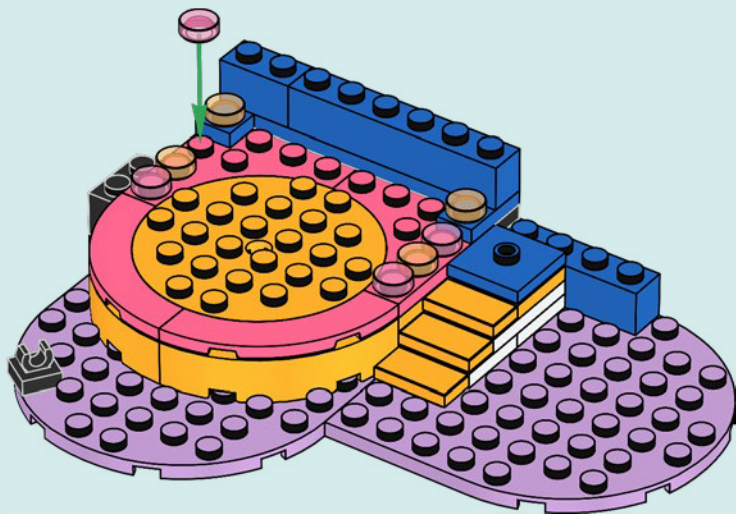

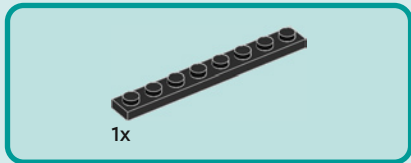

22

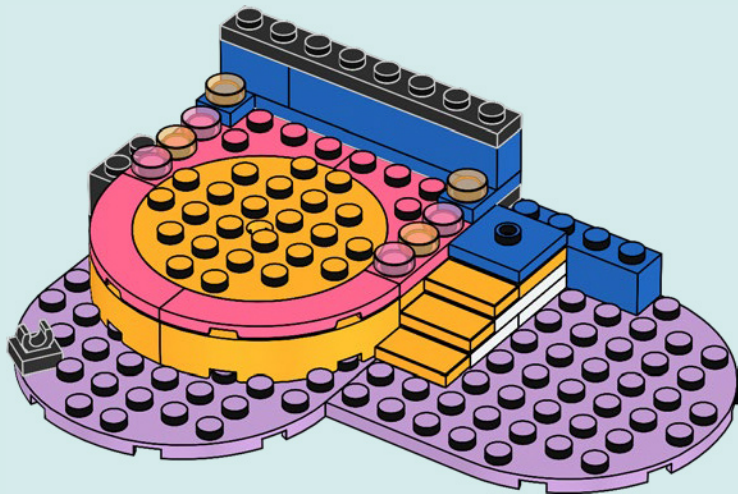



2x

23

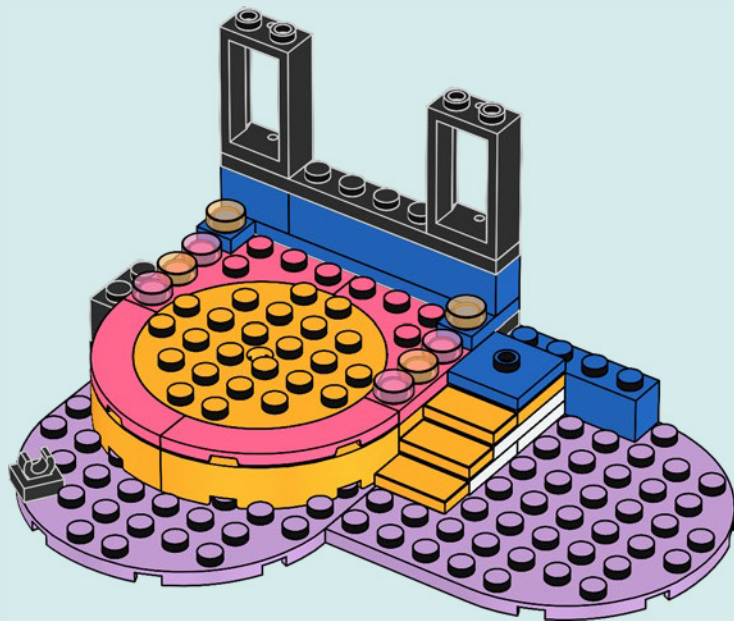

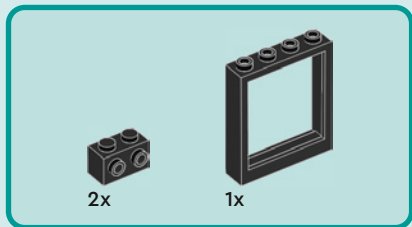

24

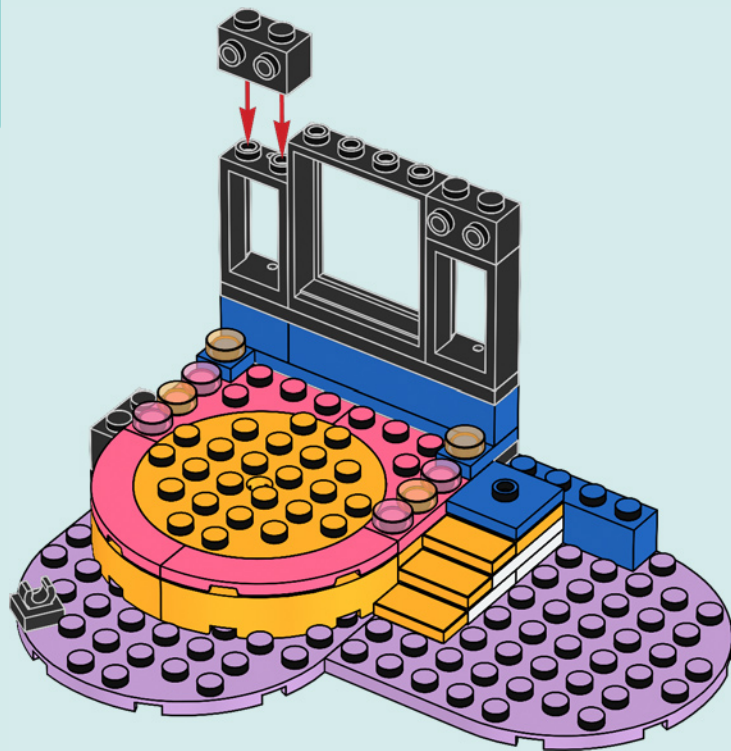



1x



1x

25

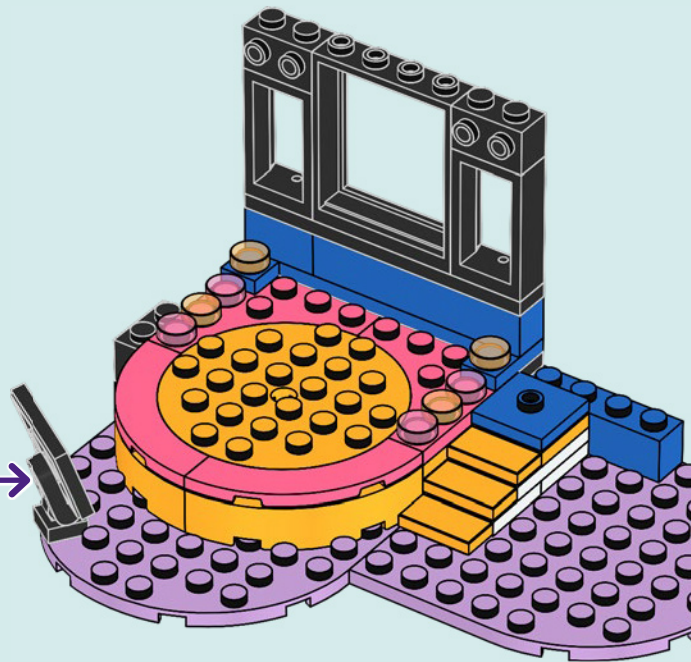
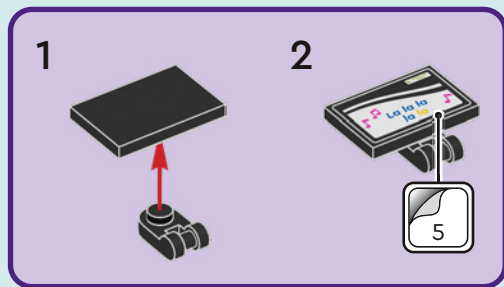

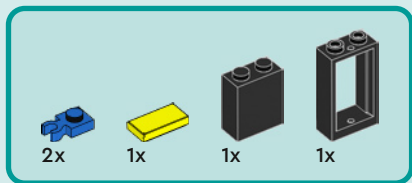

26

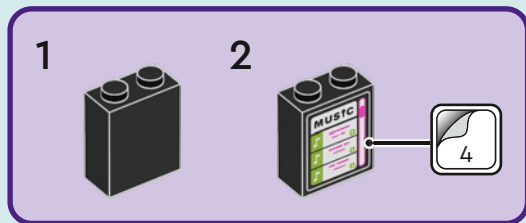

1



2

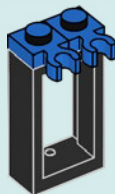

3



4



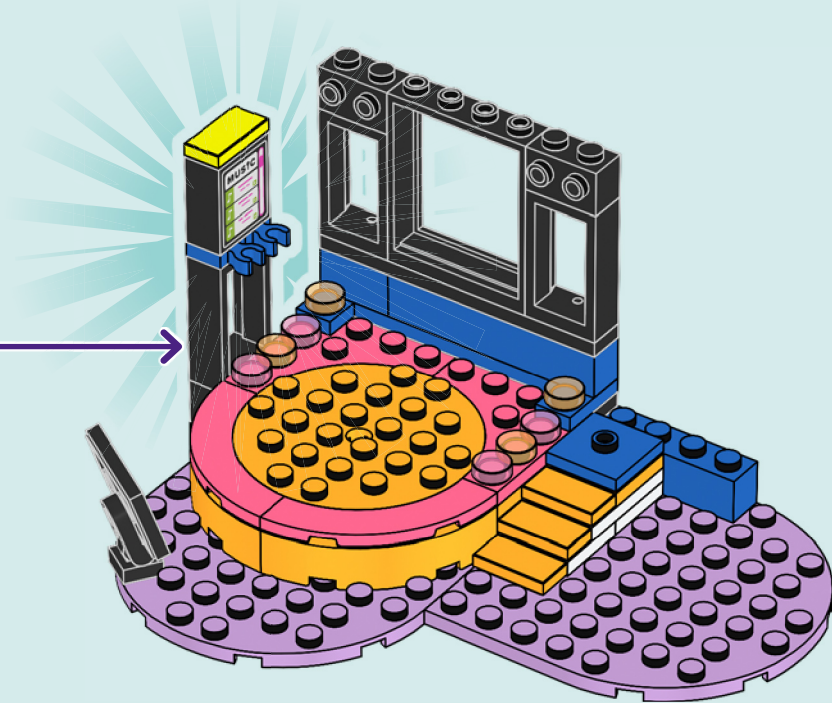



NOVA

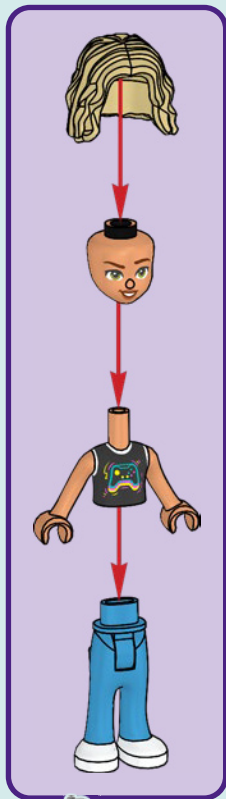

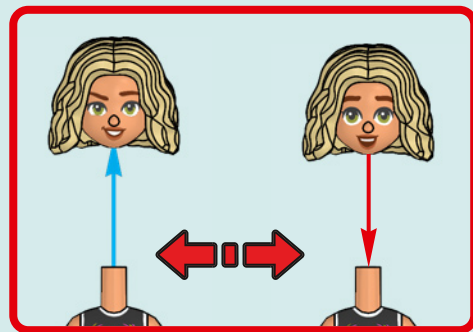



1x



1x



1x



1x



1x





1x



1x

27

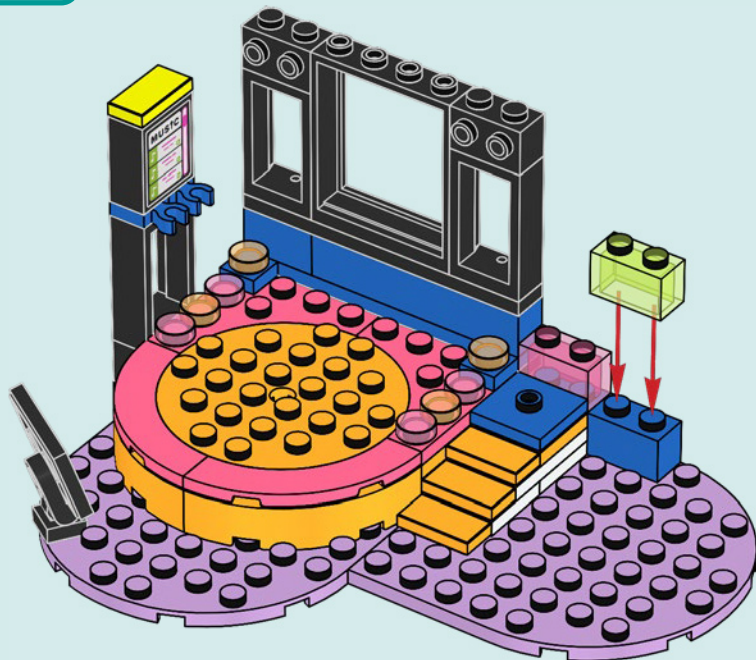



1x



2x

28

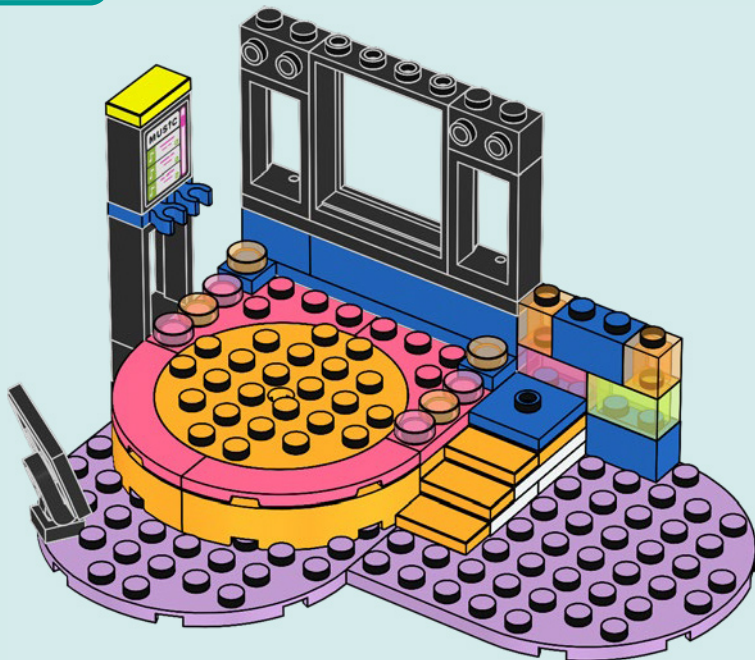



1x



1x

29

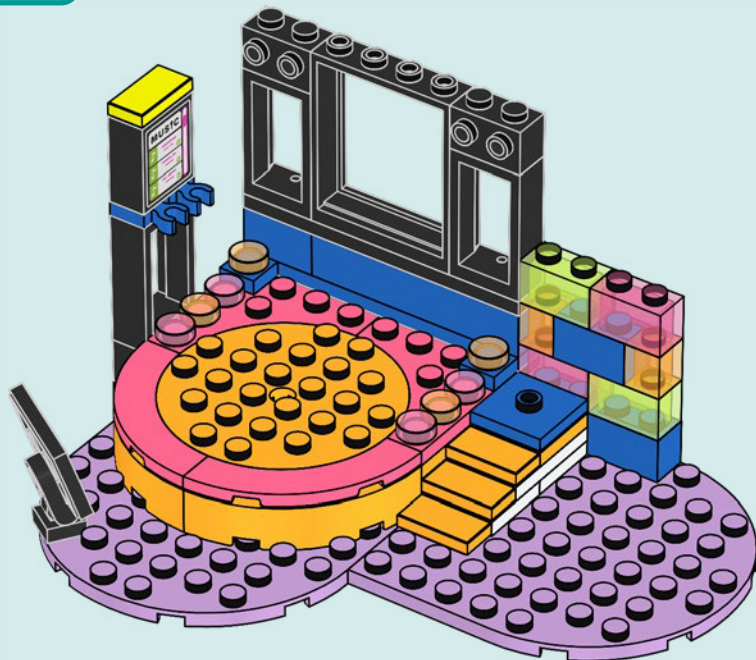



1x



2x

30

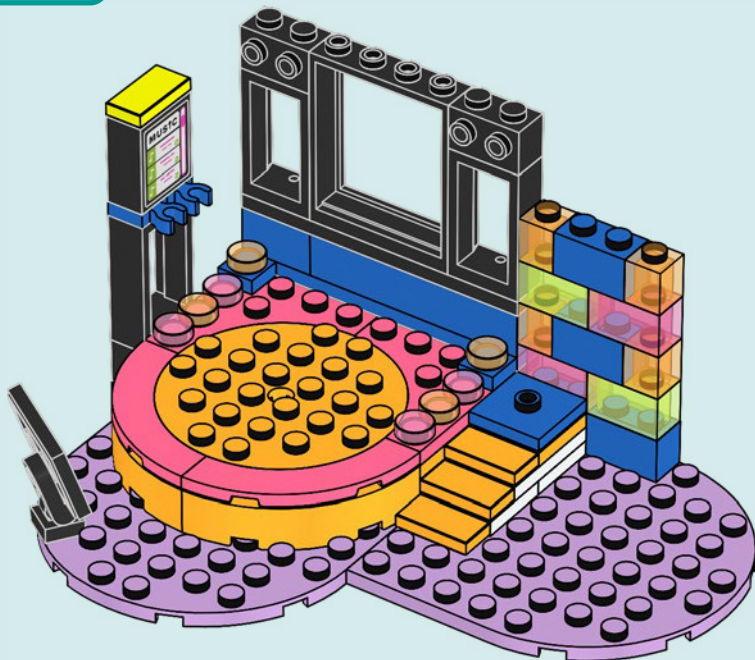



1x



1x

31

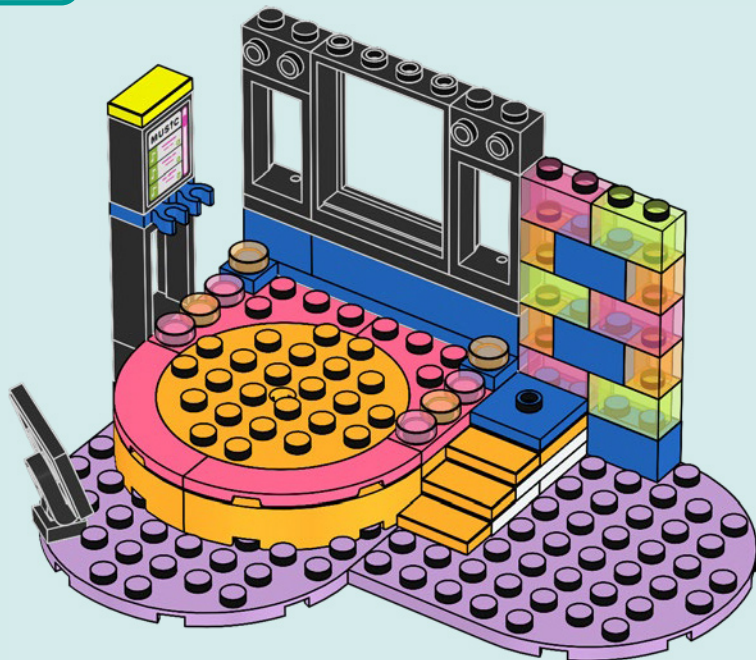

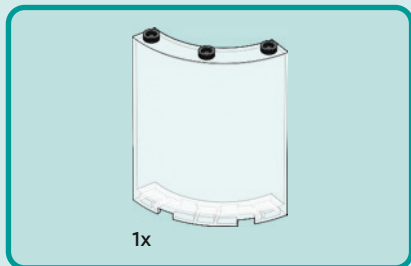

32

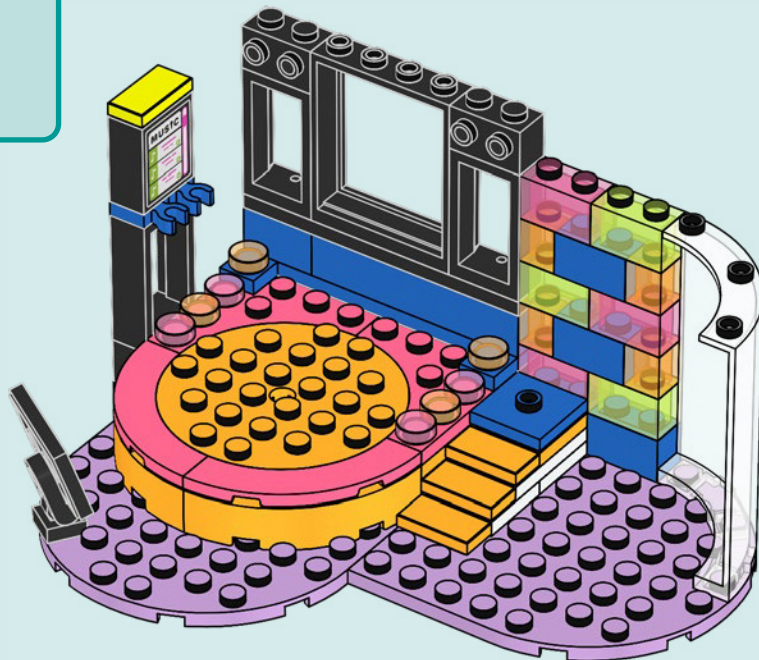

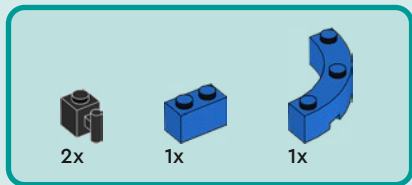

33

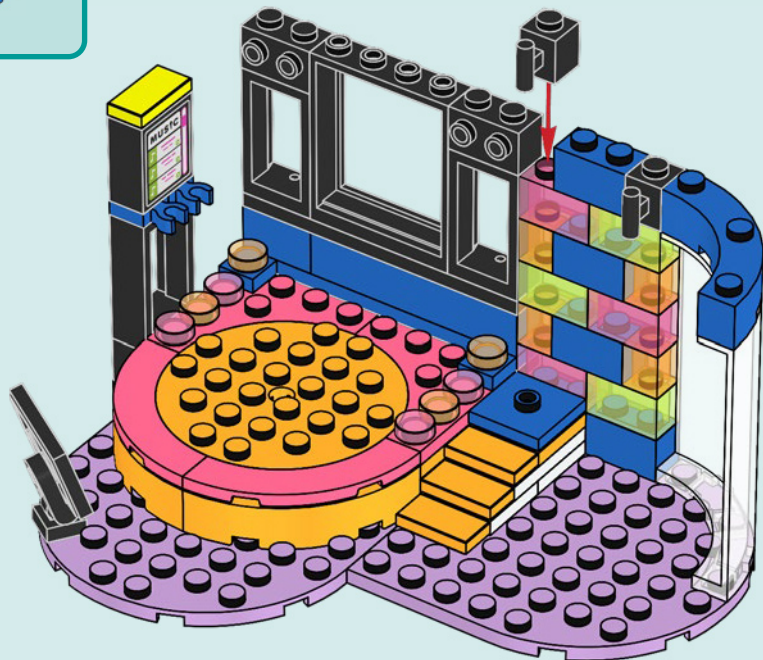



6x



1x

34

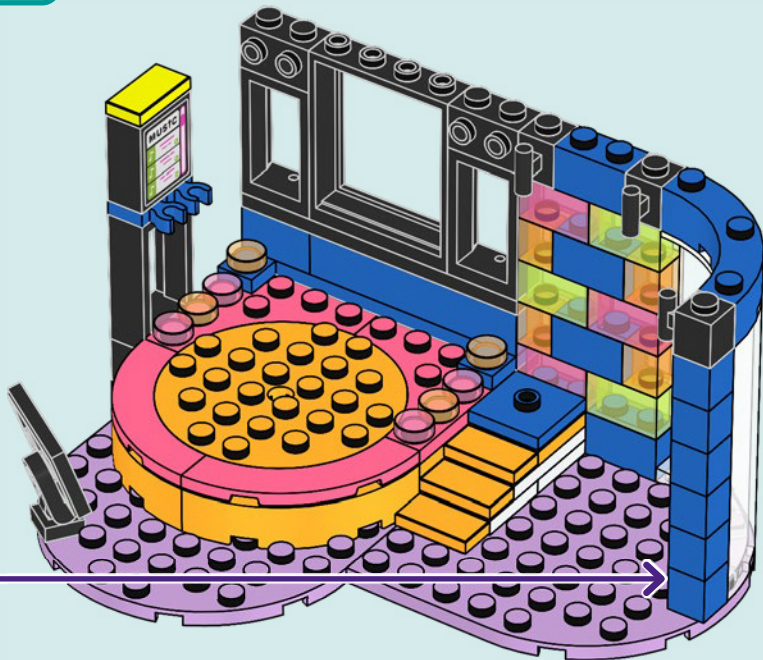
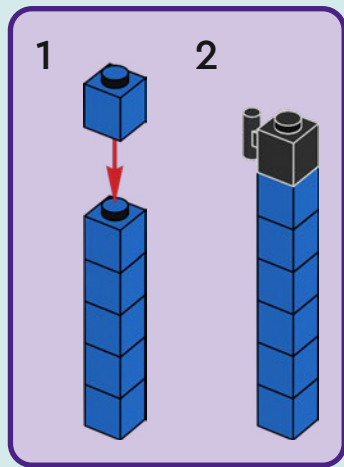

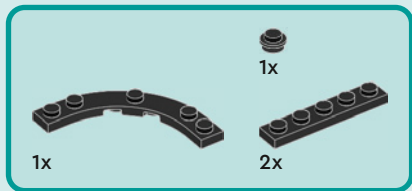

35

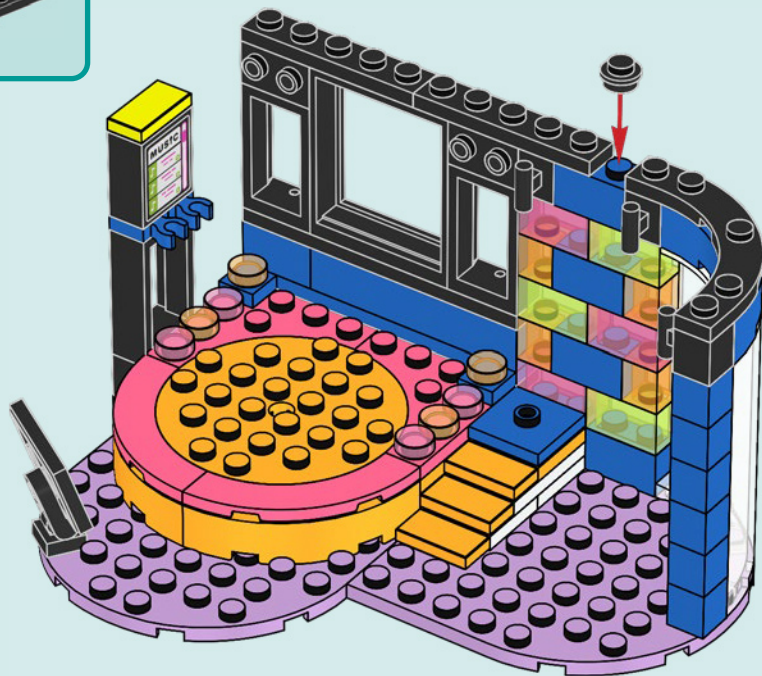

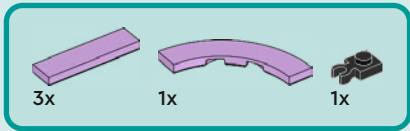

36

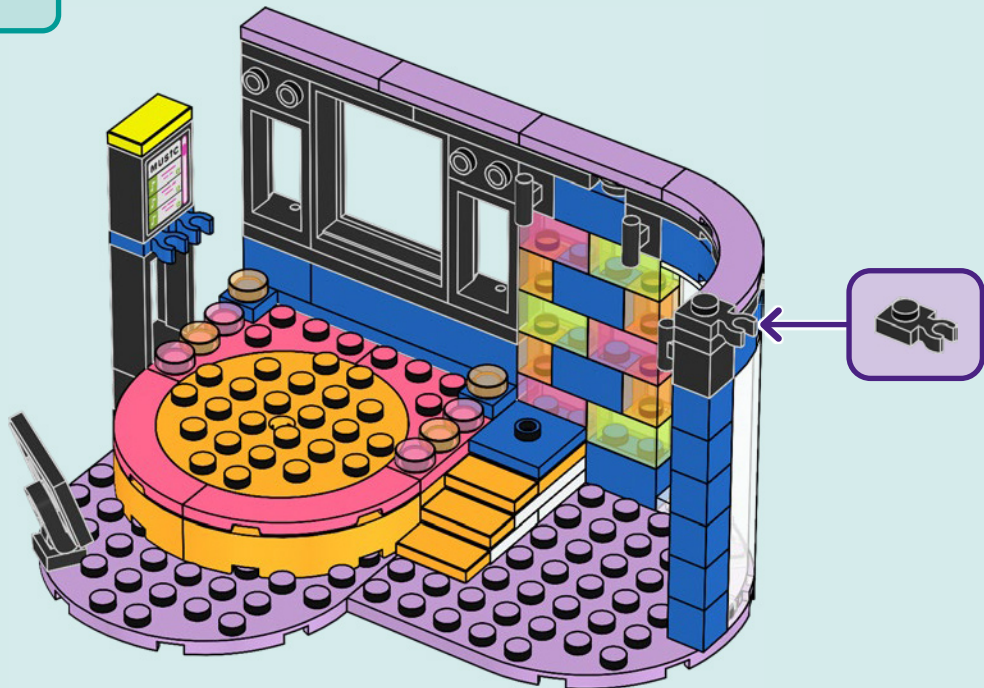

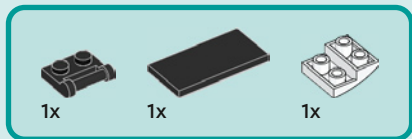

37

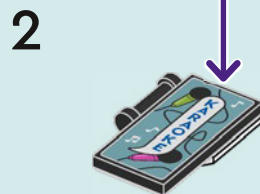
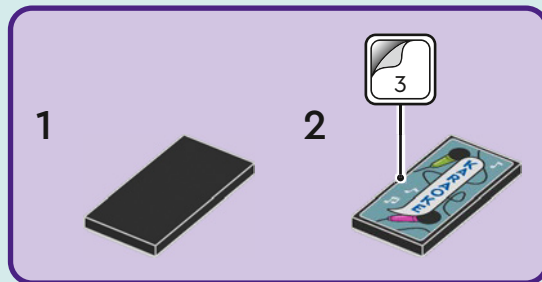
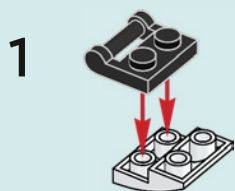

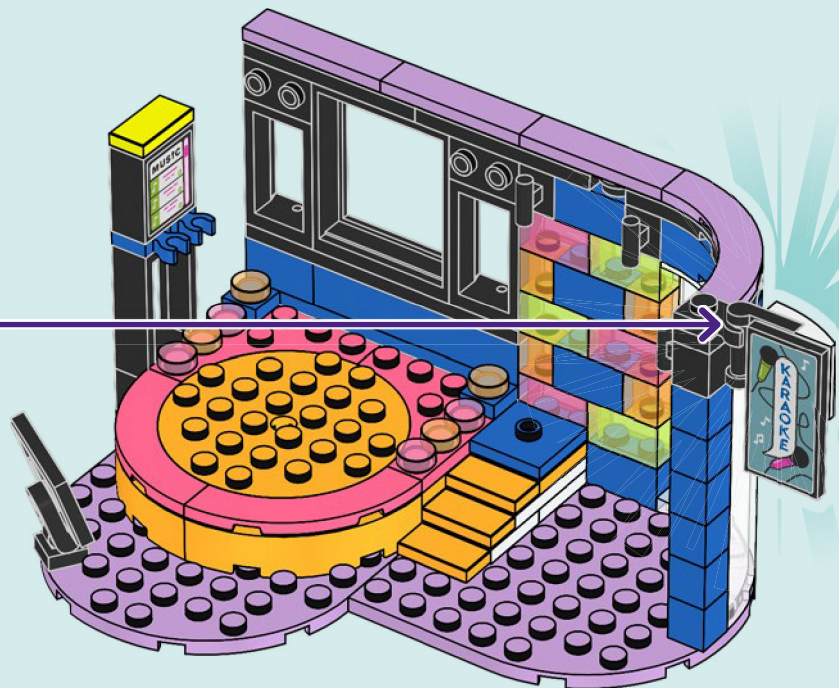

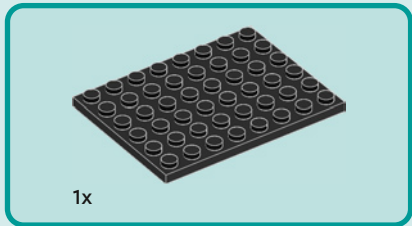

1x

38

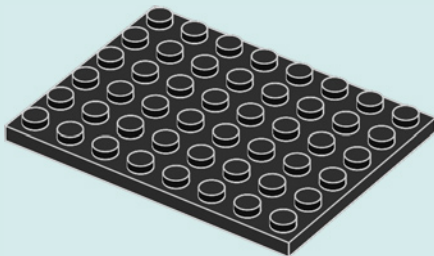



4x



4x

39

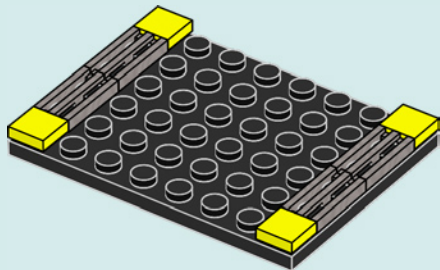

2x

40

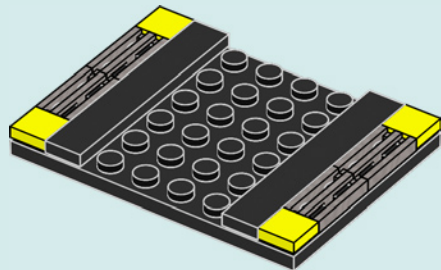

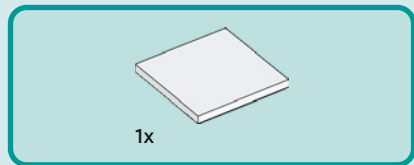

41

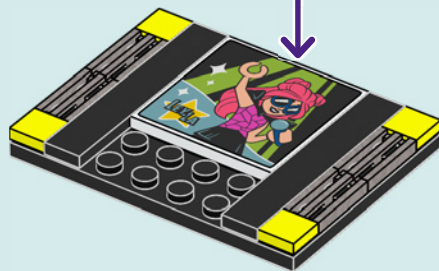
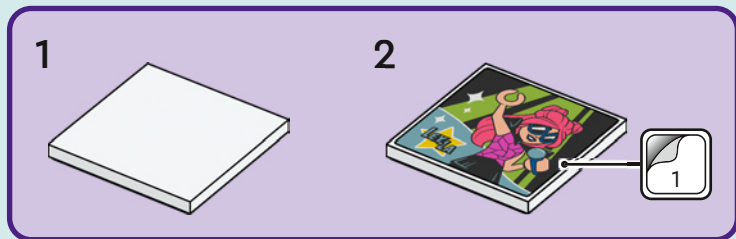

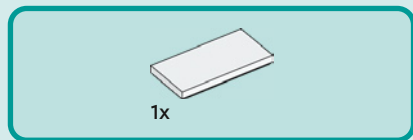

42

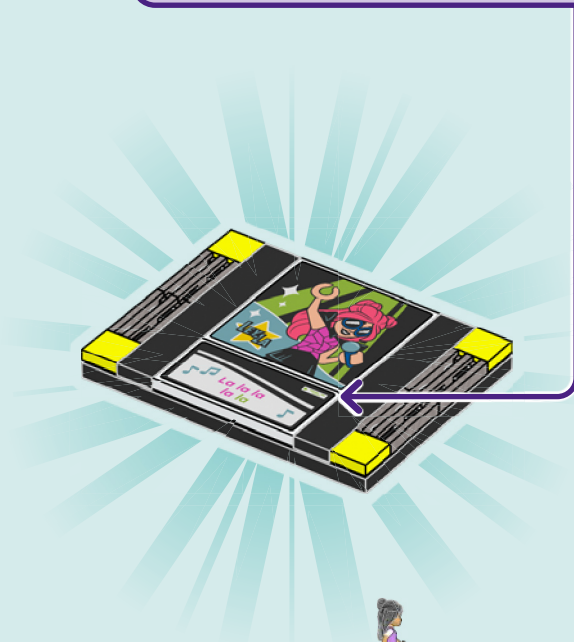
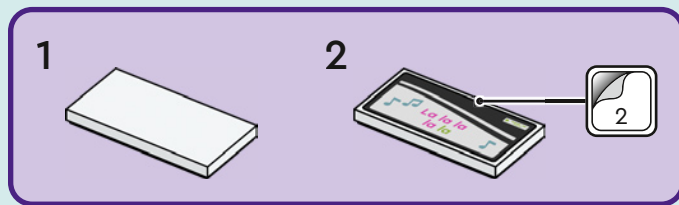

43

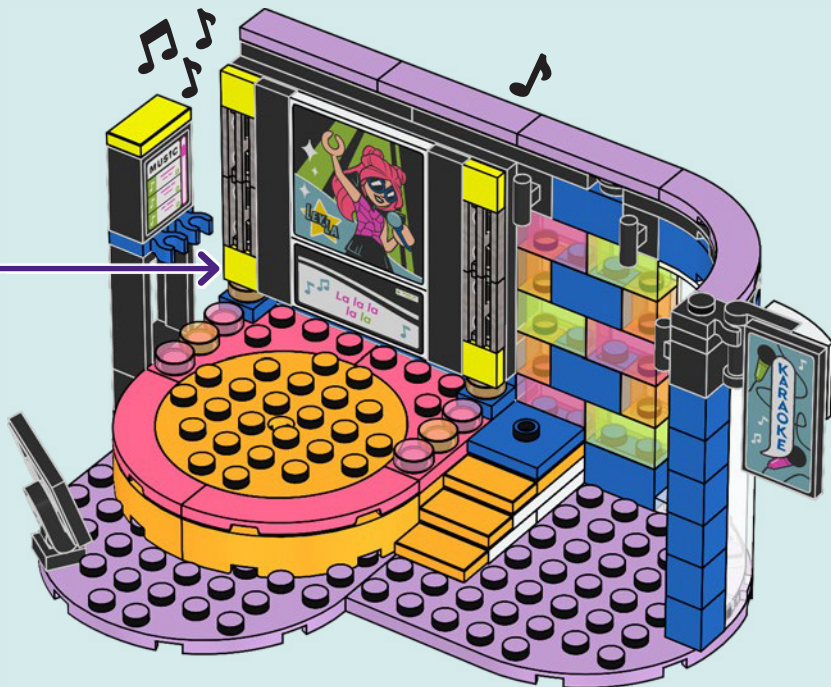



44

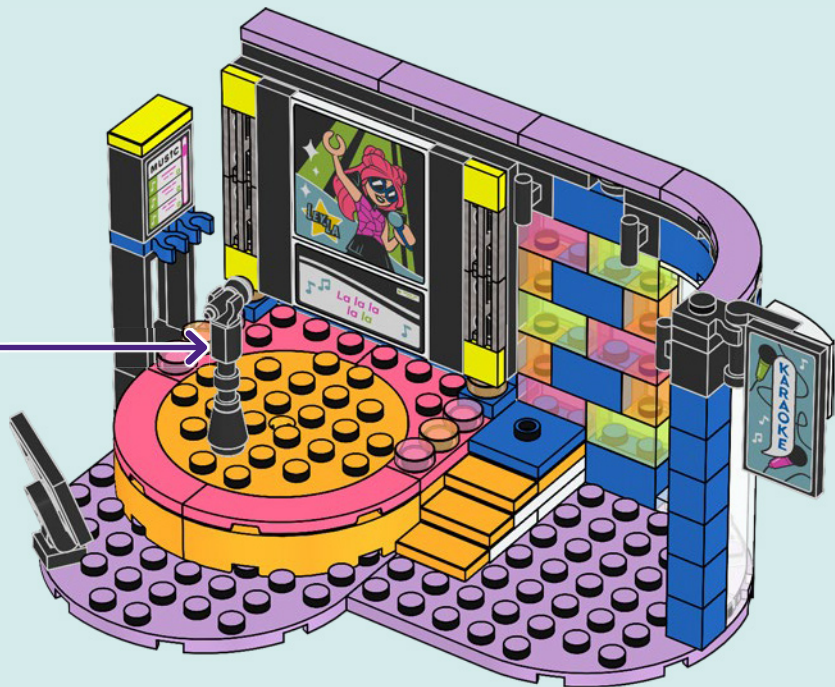
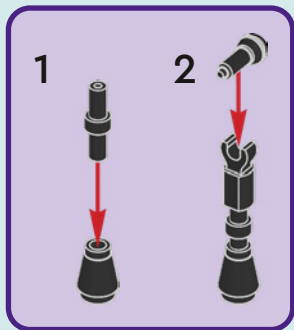



1x



1x

45



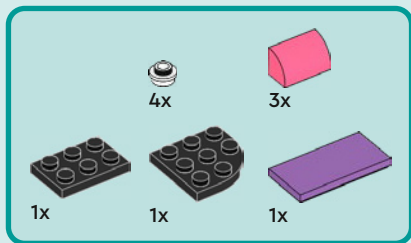

46

1

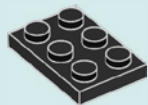

2

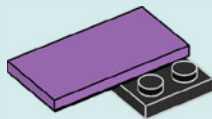

3

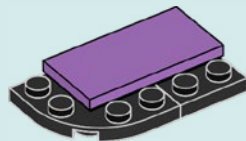

4



5

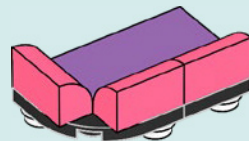

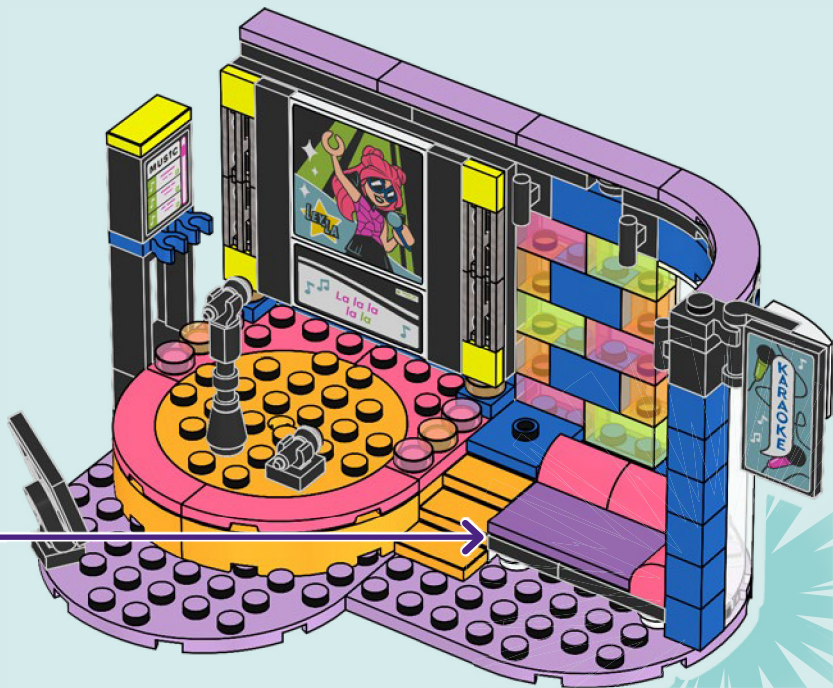



1x

47



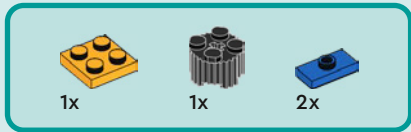

48

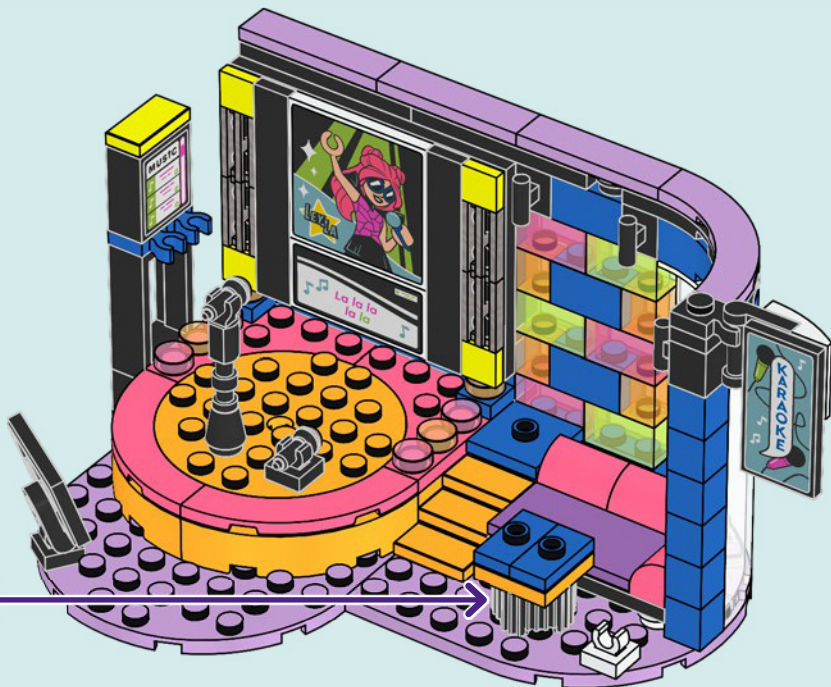
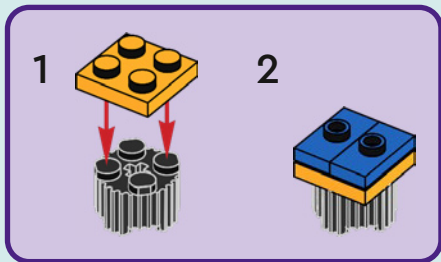



1x



1x

49

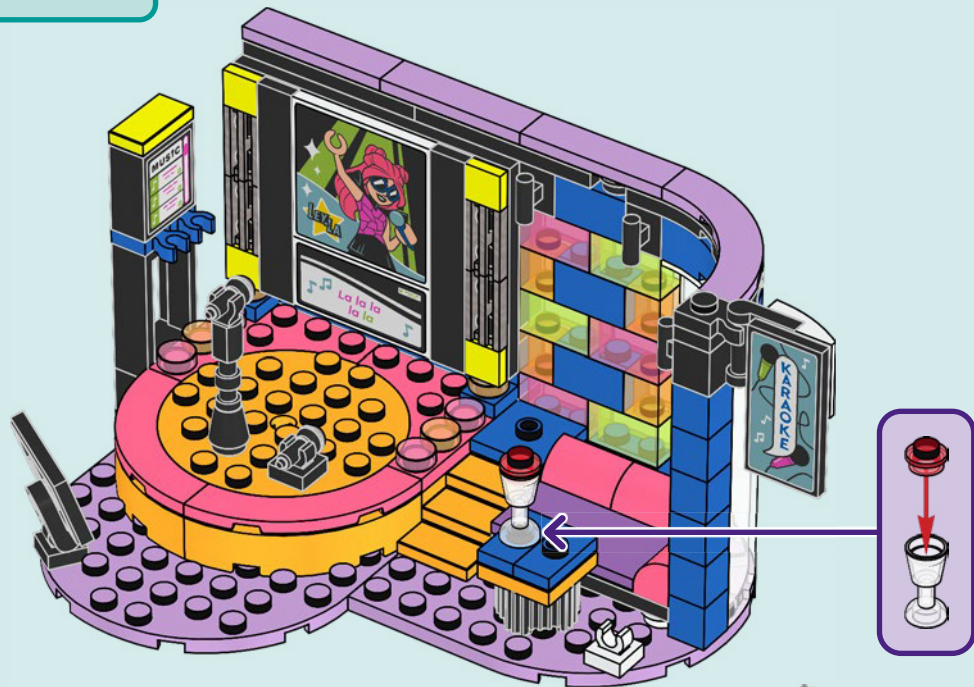

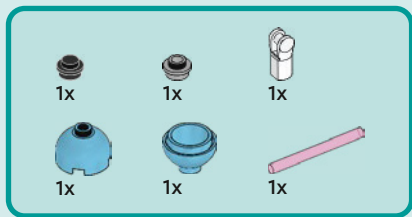

50

1



2



3



4

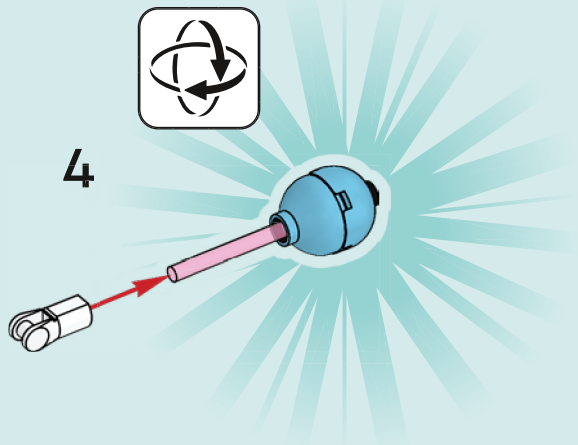

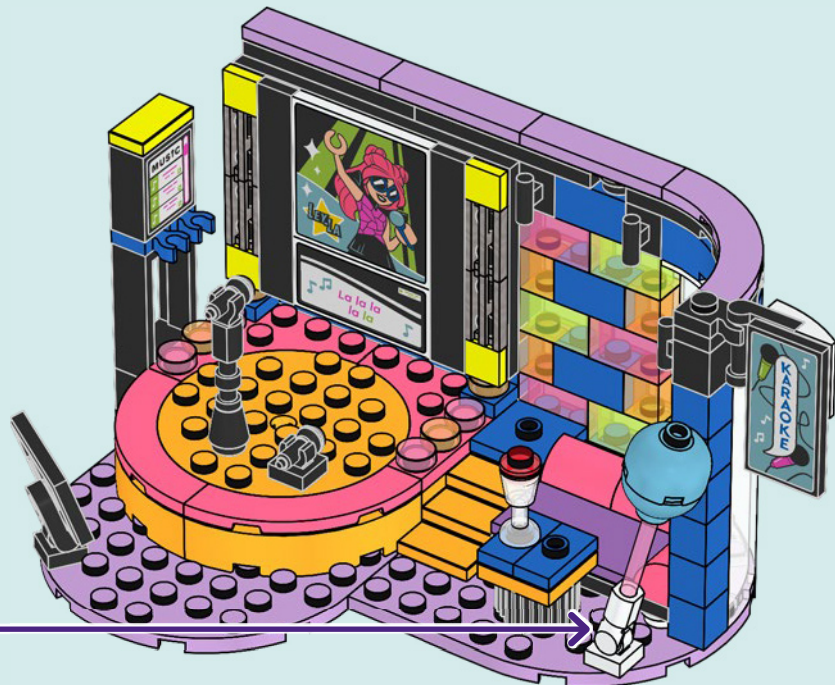



3x

51

1



2



3x

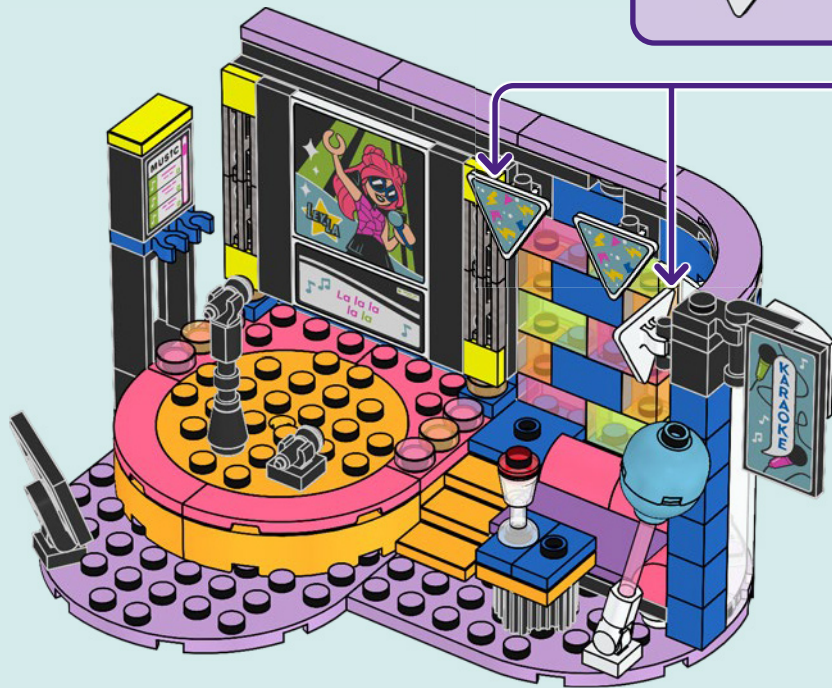

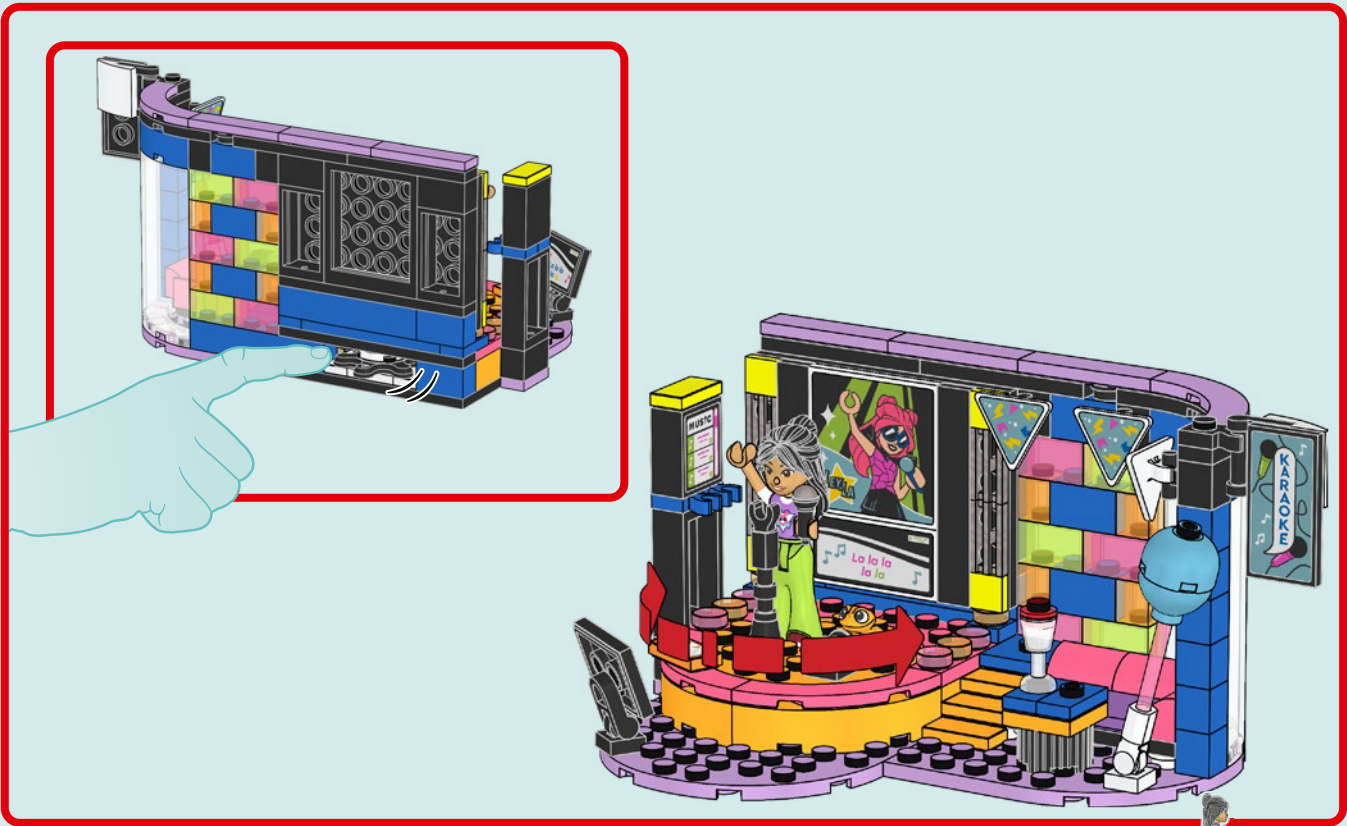

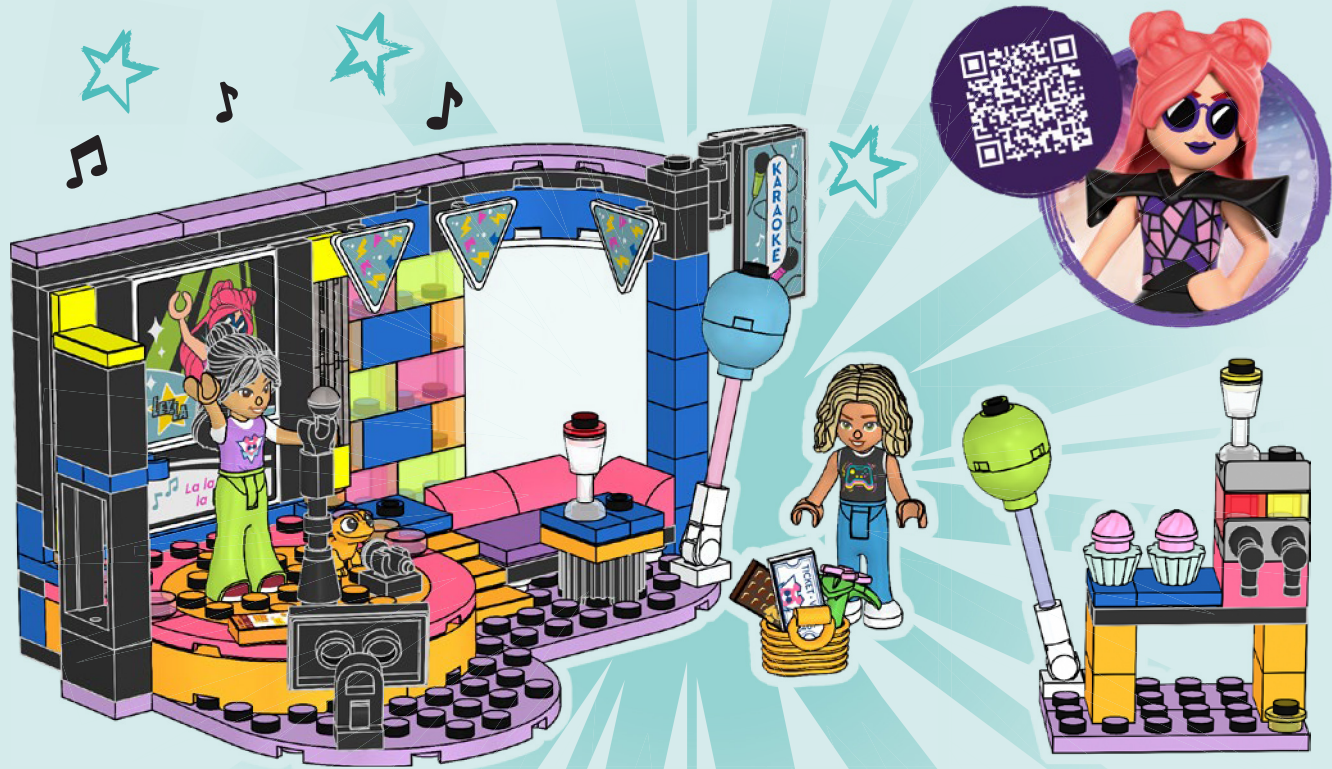



































































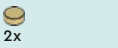











LEGO Friends

WATCH
SERIES
ONLINE

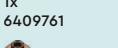

WATCH SERIES ONLINE / SCHAU DIR DIE SERIE ONLINE AN / REGARDE LA SÉRIE EN LIGNE / GUARDA LA SERIE ONLINE / MIRA LA SERIE EN INTERNET / ASSISTIR À SÉRIE ONLINE / 在线观看 /
OGLADAJ SERIAL W INTERNECIE / SLEDUJ SERIAL ONLINE / POZRI SI SERIAL ONLINE / NÉZD A SOROZATOT ONLINE / VIZIONEAZĂ SERIALUL ONLINE / ГЛЕДАЙТЕ СЕРИАЛА ОНЛАЙН /
SKATIES SĒRIĀLU TIĒŠSAISTĒ / VAATA SARJA VEEBIST / ŽIŪRĒK SĒRIALĀ INTERNETU



 2x 6322489	 3x 302101	 1x 6429738	 1x 366623	 1x 6024730	 1x 6162892	 2x 346026	 1x 6244905
 4x 6168642	 1x 4515347	 6x 300523	 2x 6327722	 1x 6409763	 1x 302126	 1x 303526	 2x 6240216
 1x 6348055	 1x 4560178	 2x 6352221	 1x 6315887	 2x 6138173	 1x 6306064	 1x 303626	 1x 6244907
 3x 6317569	 1x 4611927	 3x 6092582	 3x 614126	 3x 6468344	 1x 6254519	 1x 303626	 1x 6329699
 1x 6044691	 1x 4611927	 5x 300423	 1x 4529236	 3x 6468344	 1x 6254519	 1x 6235080	 4x 6274745
 1x 6347309	 1x 6400128	 2x 302323	 2x 459926	 1x 4618852	 1x 4560182	 1x 6235080	 3x 6244913
 2x 306901	 2x 6284573	 1x 6469255	 2x 6335388	 1x 4225201	 4x 6350415	 2x 6166107	 1x 6291400
 1x 6466347	 1x 6409761	 2x 6126049	 3x 6170566	 1x 4225201	 2x 663626	 1x 6236111	 1x 6466199
 1x 6238334	 1x 6416619	 2x 6126049	 1x 6157554	 1x 300326	 2x 663626	 1x 6236111	 1x 6214557
 1x 6210385	 1x 6466332	 2x 300923	 1x 6371584	 1x 4227392	 1x 6372045	 1x 6208450	 1x 6429057

1x
6170191

4x
6274747

4x
6240550

1x
6096091

5x
6003003

3x
4622062

1x
6416784

2x
6310615

2x
6003033

2x
6020073

1x
6131694

1x
6139435

2x
6168647

1x
4568637

2x
4211398

1x
6004990

1x
4211356

2x
6424008

1x
6096990

3x
6244911

1x
6430979

1x
6132411

1x
6429058

1x
6238331

2x
6361352

1x
4651902

1x
6099190

3x
6101169

1x
6391756

2x
6334047

2x
6273856

4x
6051422

3x
6261293

1x
6422920

2x
6400075

2x
6458179

4x
6376232

1x
6392235

1x
6416546

1x
6466195

1x
6471316

 [LEGO.com/service](https://www.LEGO.com/service)



YOU COULD
WIN



Scan this QR code or go to
LEGO.COM/PRODUCTFEEDBACK and give
us your short feedback about this LEGO® set
for a chance to win a cool LEGO prize.

Terms and Conditions apply*

EN: YOU COULD WIN. Terms and Conditions apply* **DE: Du könntest GEWINNEN.** Es gelten die Teilnahmebedingungen* **FR: Tu pourrais GAGNER.** Des conditions s'appliquent* **IT: Potresti VINCERE tu.** Termini e condizioni sono applicabili* **ES: Puedes GANAR.** Aplican términos y condiciones* **PT: Poderá GANHAR.** Aplicam-se termos e condições* **ZH: 轻松获奖. 条款和条件适用*** **PL: Szansa na WYGRANĄ.** Obowiązują warunki korzystania* **CS: Máte šanci VYHRÁT.** Platí všeobecné smluvní podmínky* **SK: Máte šancu VYHRAŤ.** Platia všeobecné zmluvné podmienky* **HU: TE IS NYERHETSZ.** Felhasználási feltételek érvényesek* **RO: Ai putea CÂȘTIGA.** Se aplică termenii și condiții* **BG: Можете да СПЕЧЕЛИТЕ.** Има определени правила и условия* **LV: Tu vari LAIMĒT.** Ir spēkā noteikumi un nosacījumi.* **ET: Sul on võimalus VÕITA.** Kehtivad tingimused* **LT: Jūs galite LAIMĖTI.** Taikomos sąlygos*

*[LEGO.com/productfeedback-terms](https://www.lego.com/productfeedback-terms)

LEGO, the LEGO logo and the FRIENDS logo are trademarks of the LEGO Group.

©2024 The LEGO Group.

6493314