



Friends

42609







LEGO® Builder



LEGO.com/sustainable-packaging



 ^{FR} **DONNEZ**
OU
RECYCLEZ

 OU  OU 

ASSOCIATION MAGASIN DÉCHÈTERIE

Adresses sur quefairedemesdechets.fr

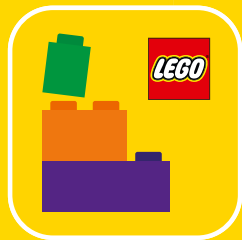

BUILDER



Apple and the Apple logo are trademarks of Apple Inc., registered in the U.S. and other countries and regions. App Store is a service mark of Apple Inc. Google Play and the Google Play logo are trademarks of Google LLC. Tencent and the Tencent logo are trademarks of Tencent Inc.

Q LEGO.com/devicecheck

EN Ask parents' permission before going online | **DE** Eltern um Erlaubnis bitten, bevor du online gehst | **FR** Demande l'autorisation d'un parent avant d'aller en ligne | **IT** Chiedi il permesso ai tuoi genitori prima di andare online | **ES** Pídeles permiso a tus papás antes de conectarte a Internet | **PT** Pede autorização aos pais antes de acederes online | **ZH** 上网前应先征得父母的同意 | **PL** Poproś rodziców o zgodę, zanim wejdziesz do Internetu | **CS** Než půjdeš na internet, požádej rodiče o svolení | **SK** Skôr než pôjdeš na internet, vypýtaj si povolenie od rodičov | **HU** Kérj szülői engedélyt, mielőtt online csatlakoznál! | **RO** Cere permisiunea părinților înainte de a te conecta online | **BG** Поискайте разрешение от родител, преди да влезете онлайн | **LV** Pirms došanās tiešsaistē palūdz atļauju vecākiem | **ET** Enne Interneti kasutamist küsi vanematelt luba | **LT** Prieš prisijungdami prie interneto, atsiklauskite tėvų

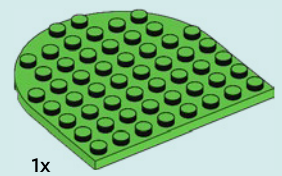
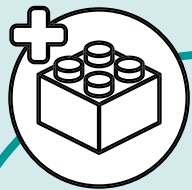

1x



ZAC

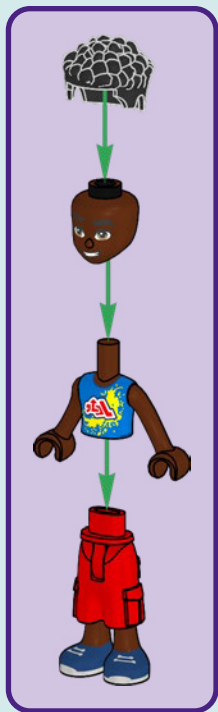

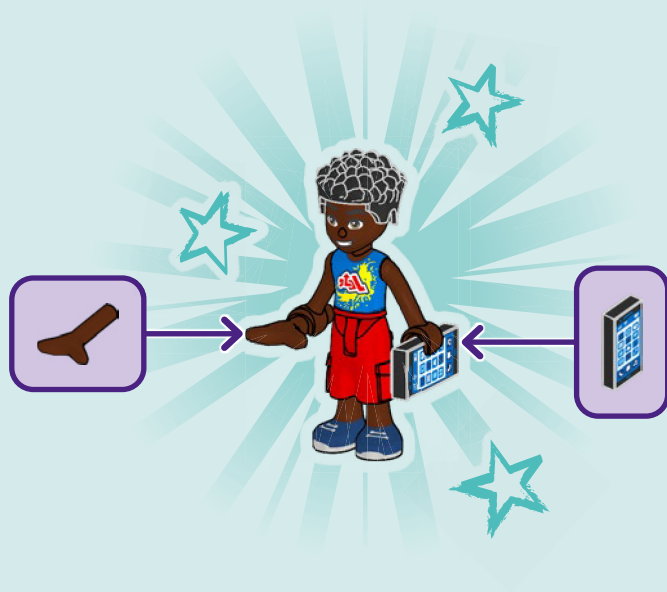



NOVA

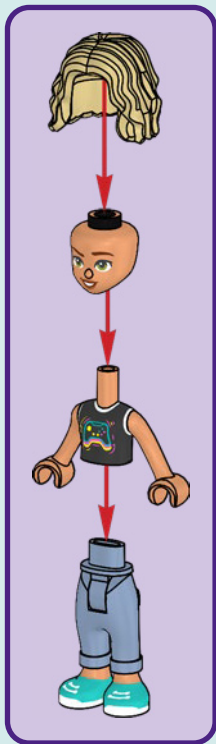

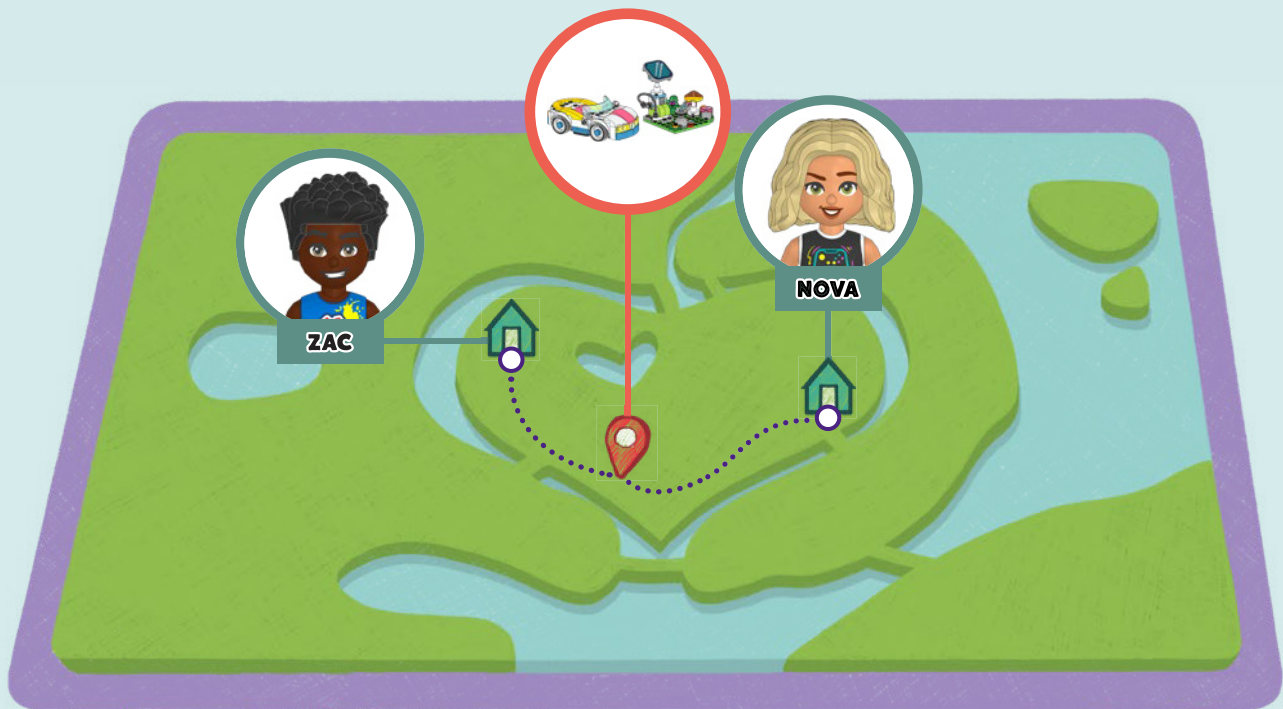

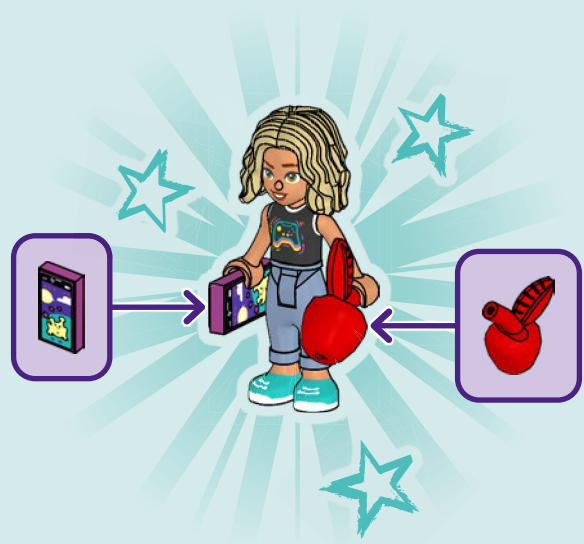

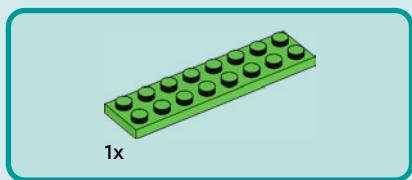

1

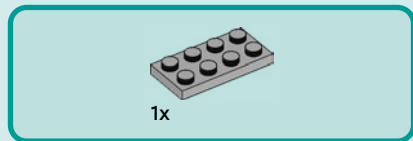
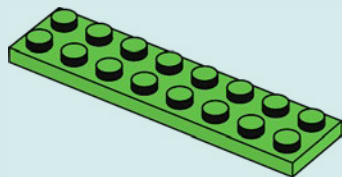

2

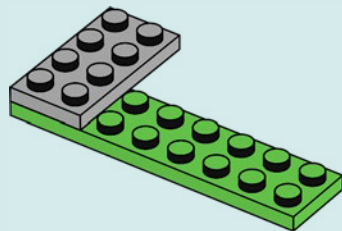

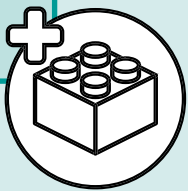
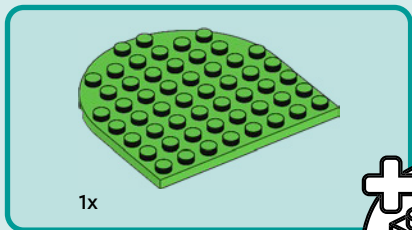

3

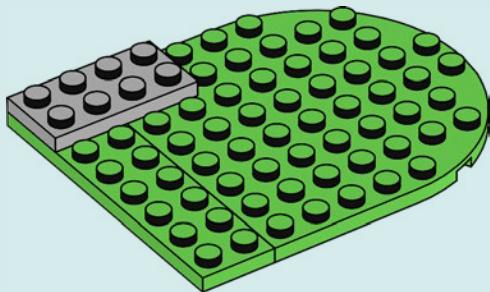

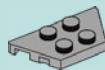

1x

4

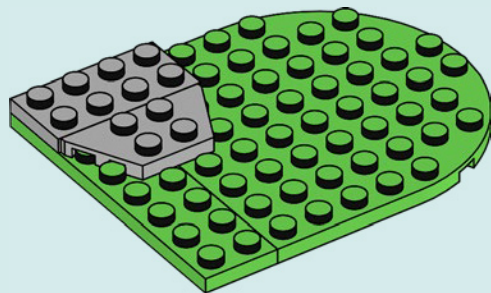

1x



1x

5

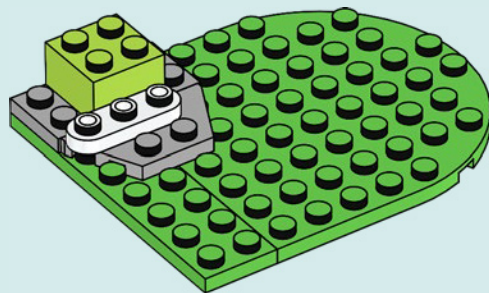



2x

6

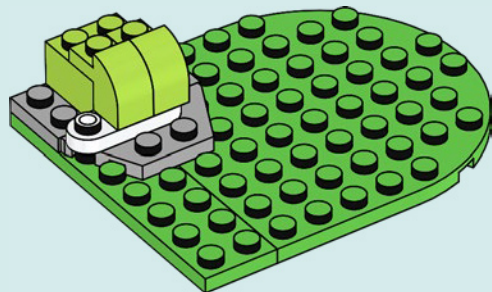



1x



1x

7

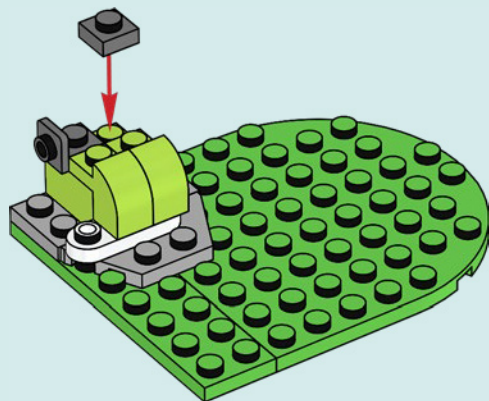

1x

8

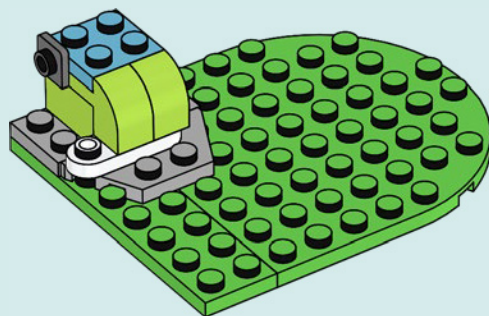



1x

9

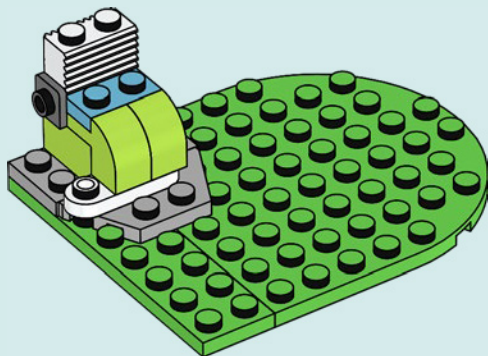

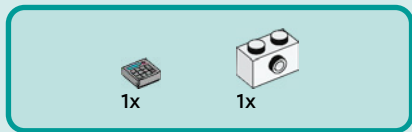

10

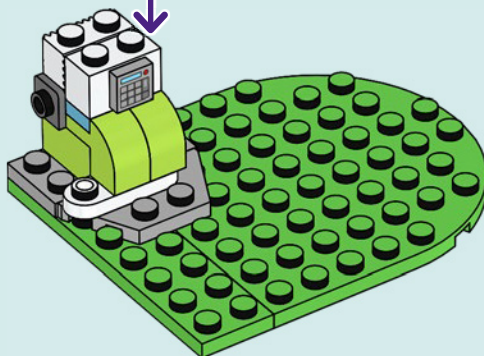
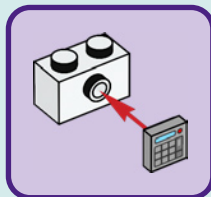



1x

11

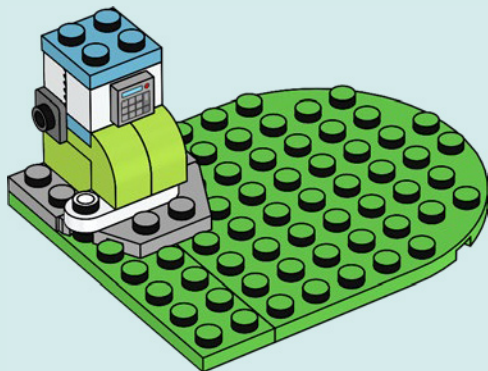



1x

12

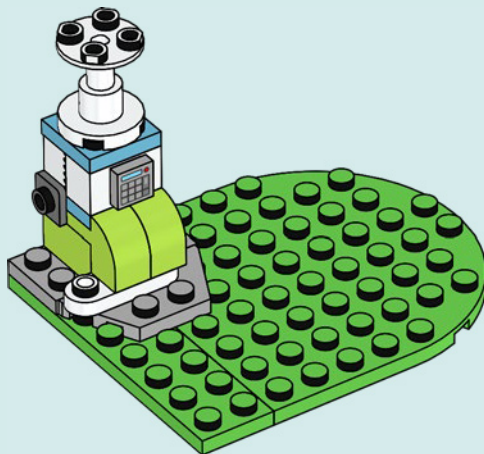

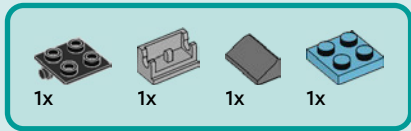

13

1

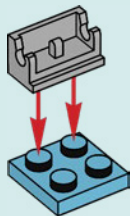

2

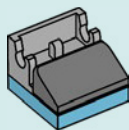

3

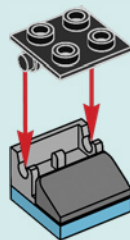

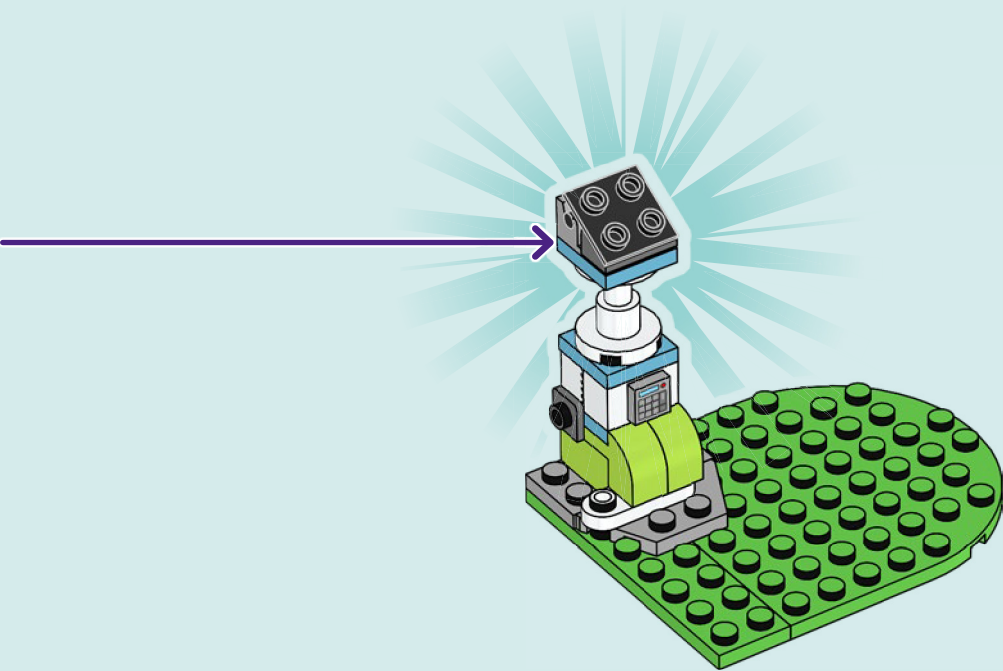

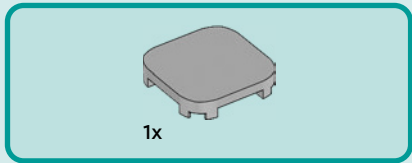

14

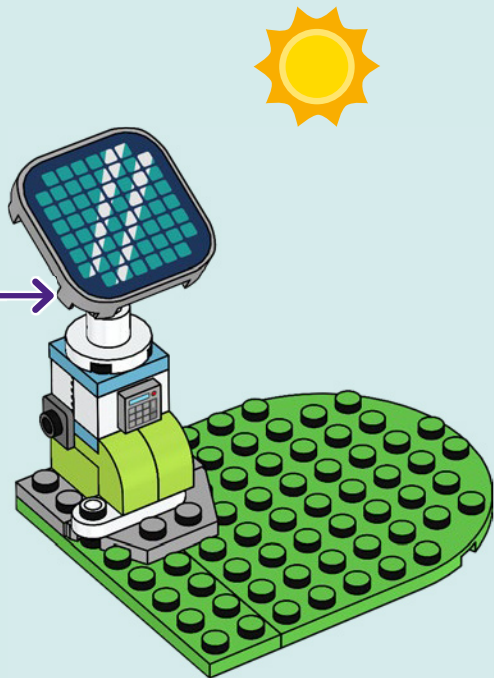
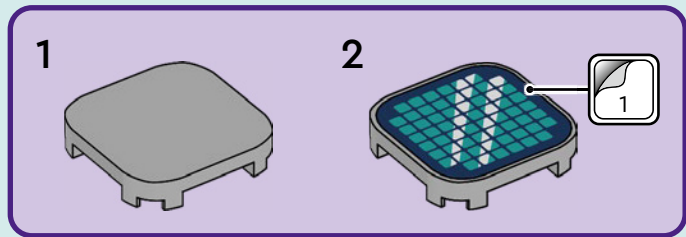

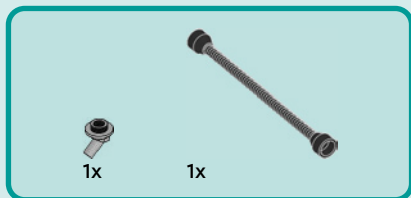

15

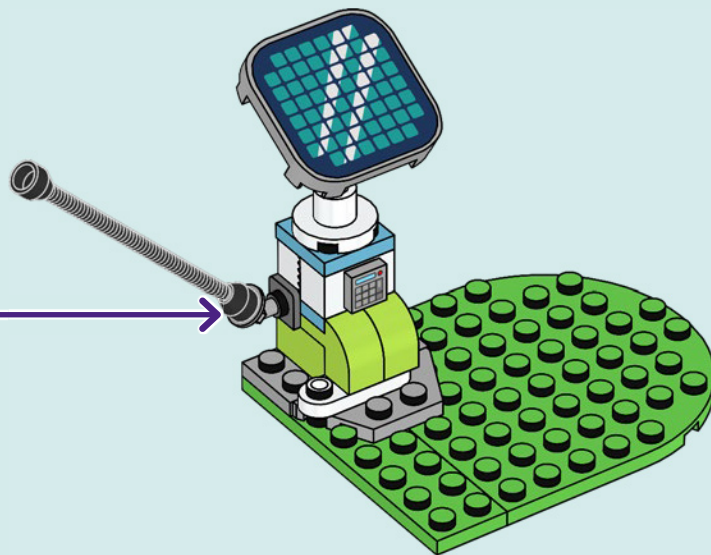
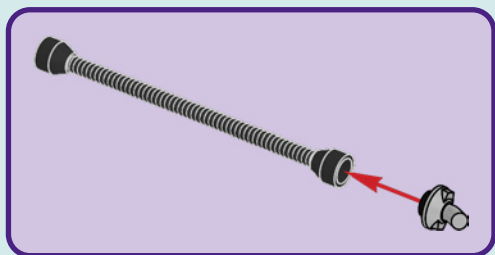

16

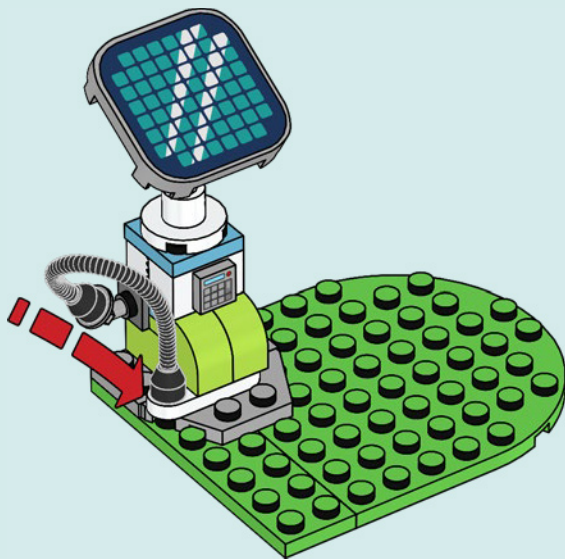



1x



1x

17

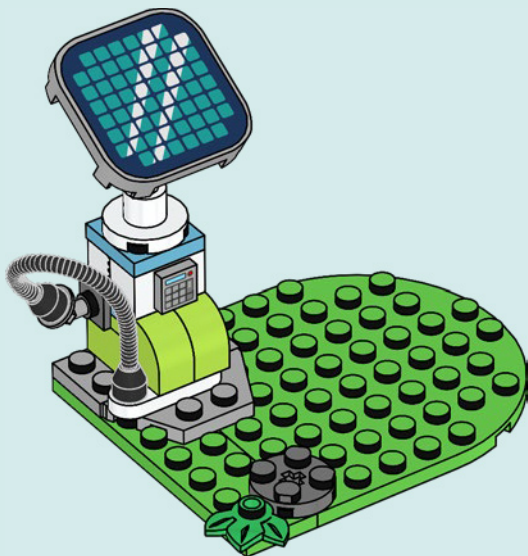

1x



1x

18

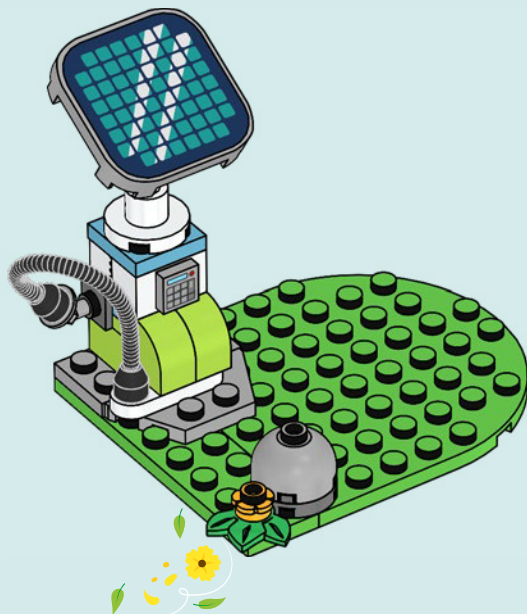

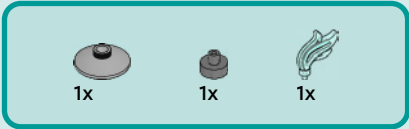

19

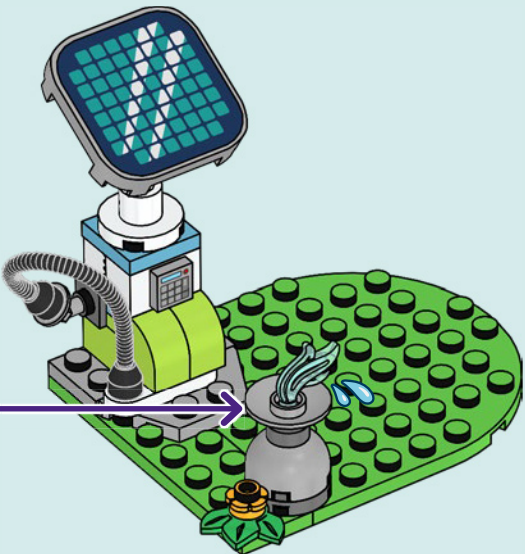
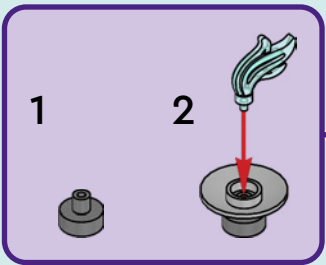

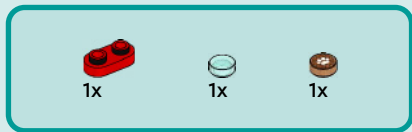

20

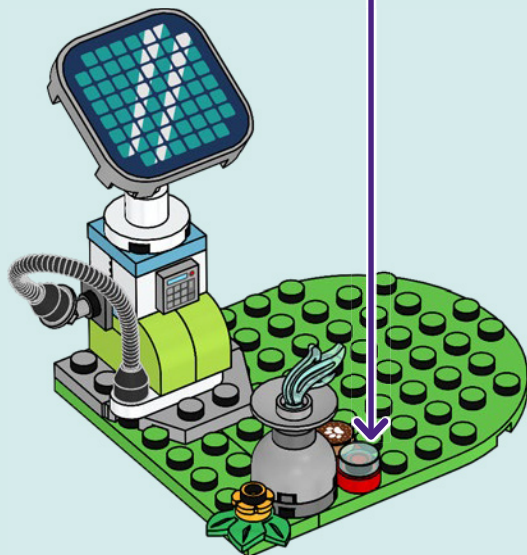



21

1



2



3



4

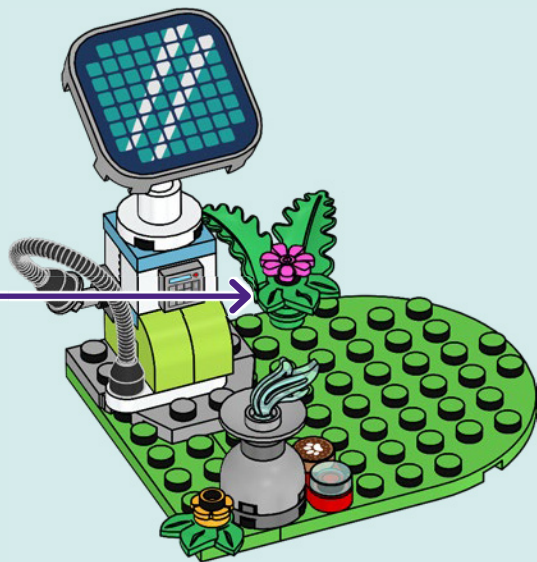



1x

22





2x



2x

23

1



2



2x

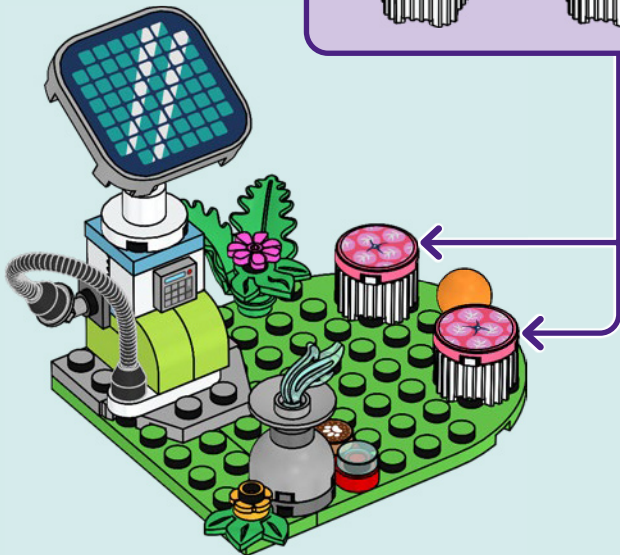

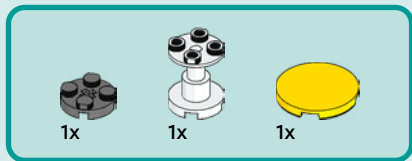

24

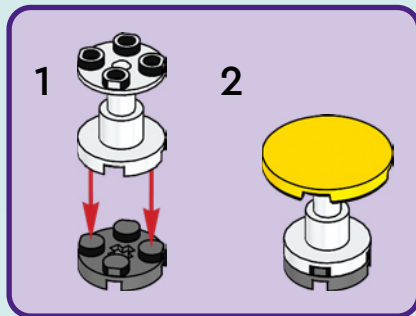



1x

25



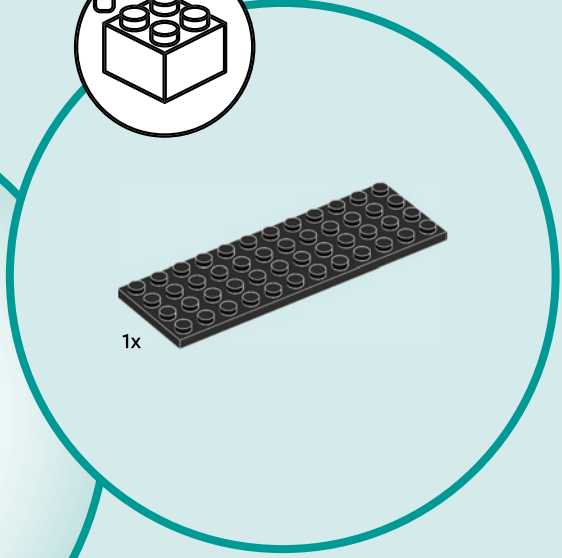
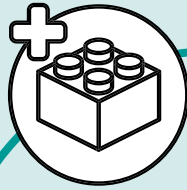

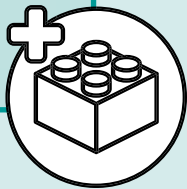
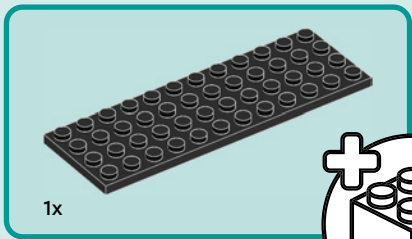
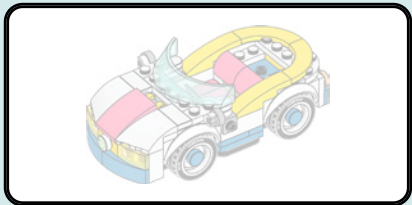

1

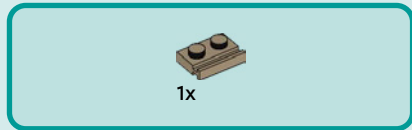
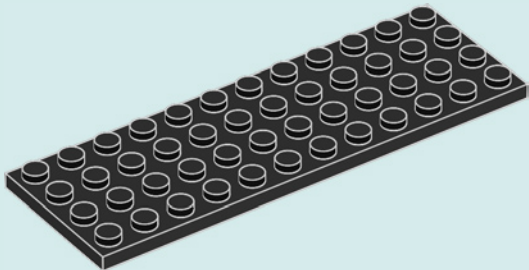

2

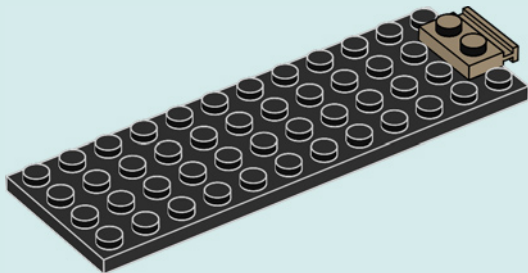



2x

3

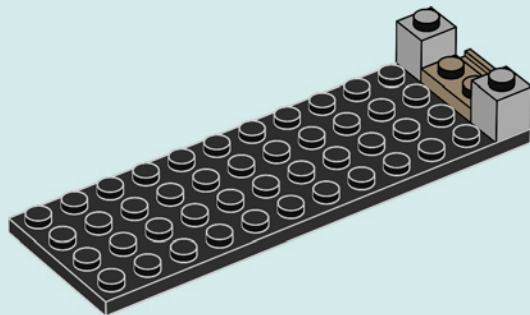



1x

4

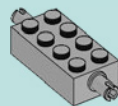
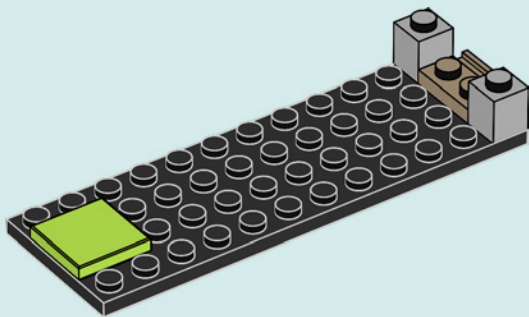

2x

5

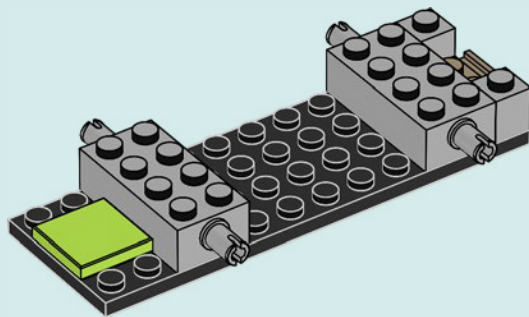

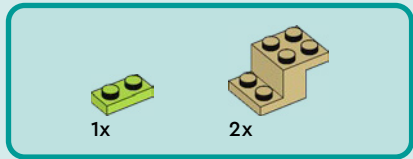

6

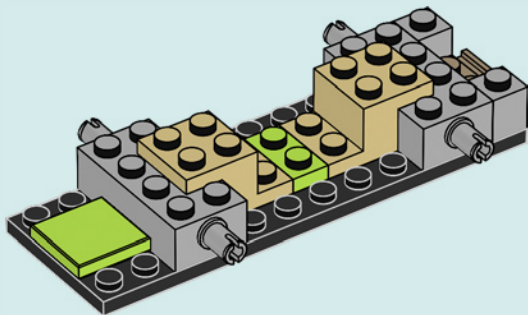



6x

7

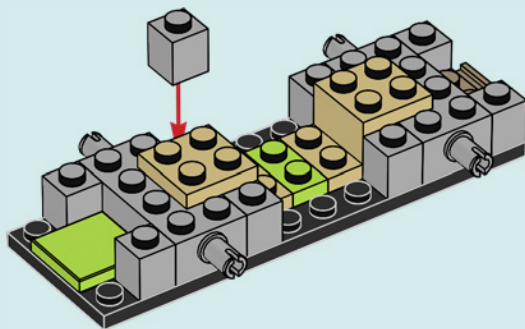

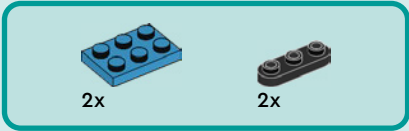

8

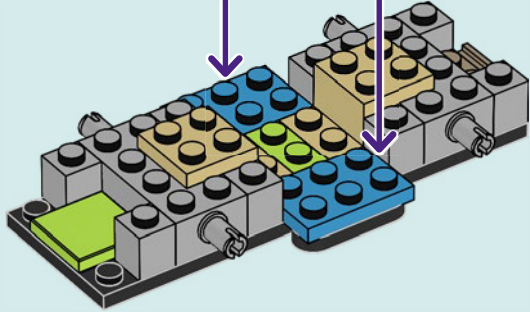

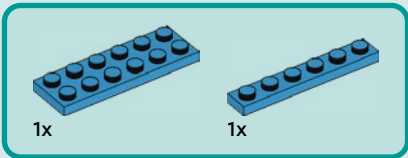

9

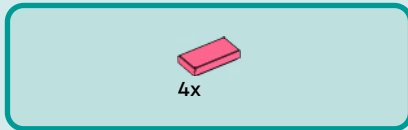
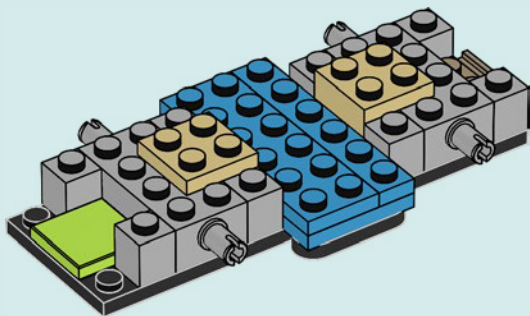

10

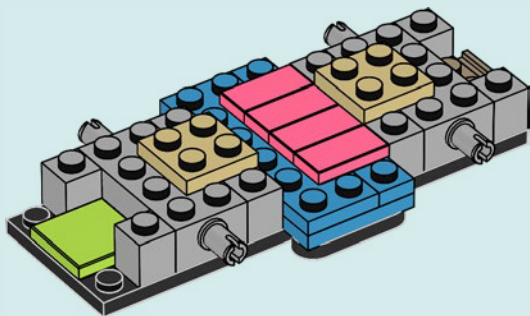



2x

11

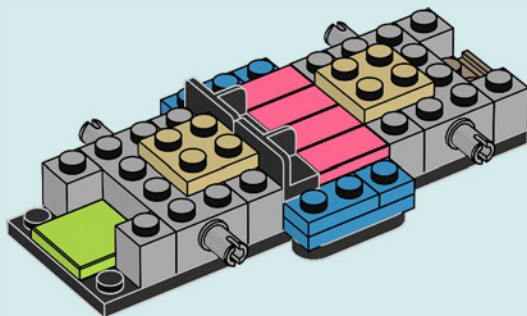



1x

12

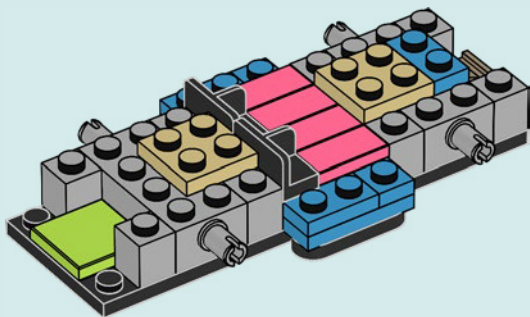

1x

13

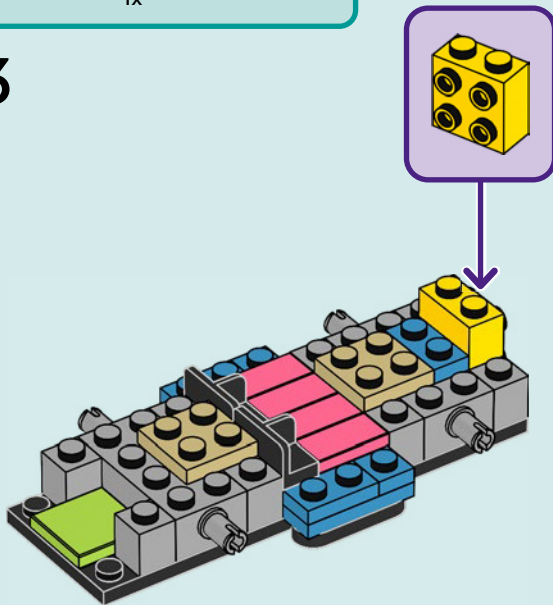



2x

14

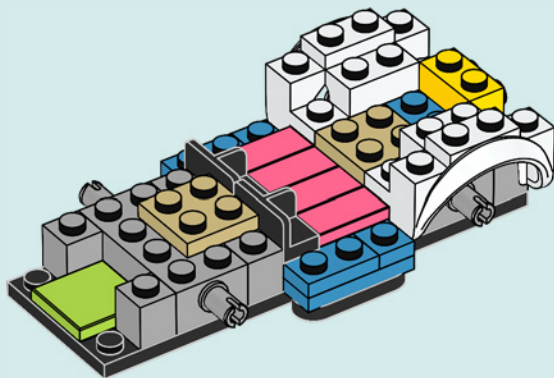



2x

15

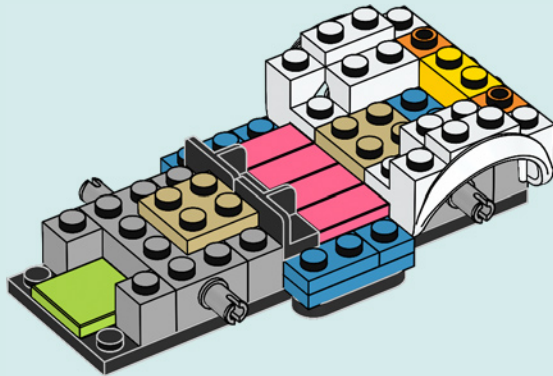



1x

16

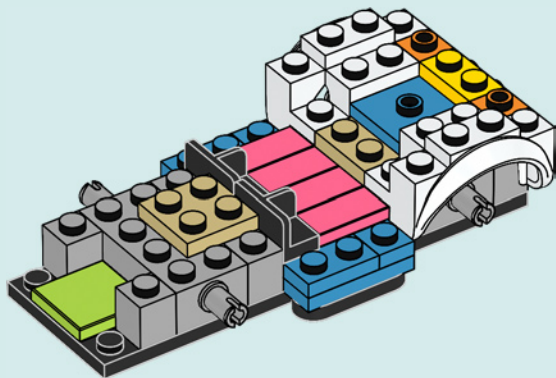



2x

17

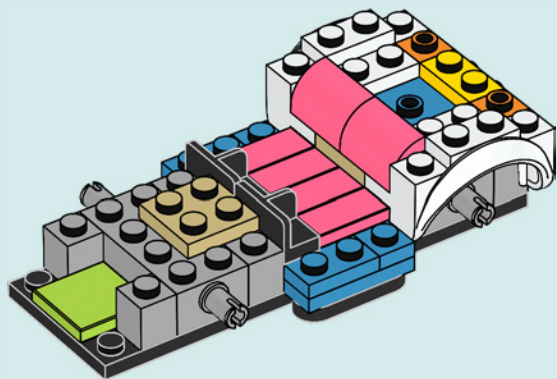

2x

18

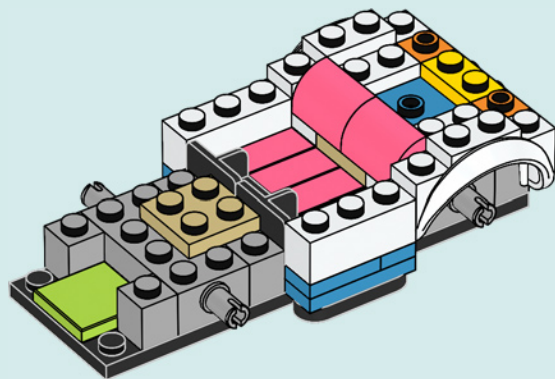

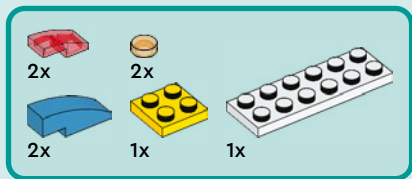

19

1

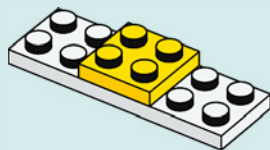

2

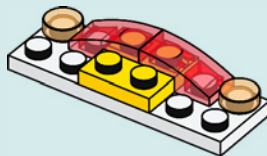

3

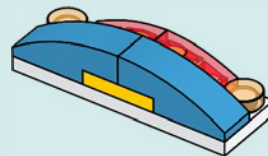

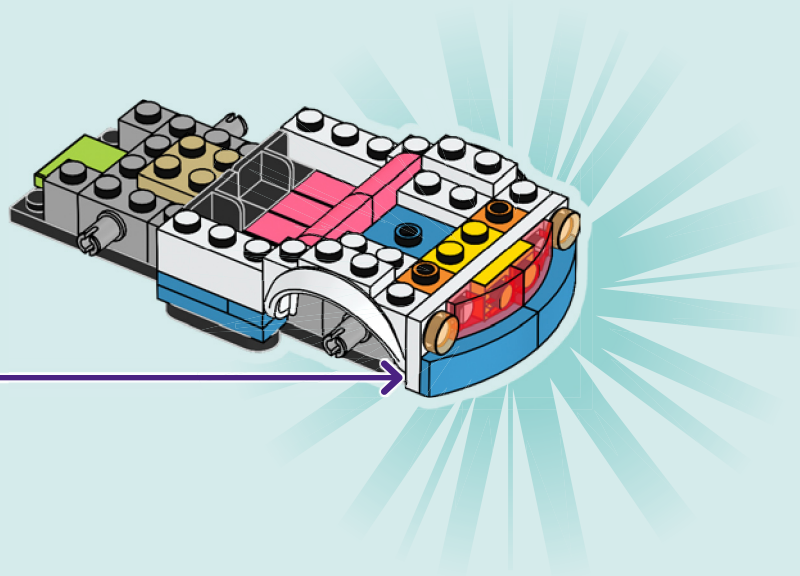



1x

20

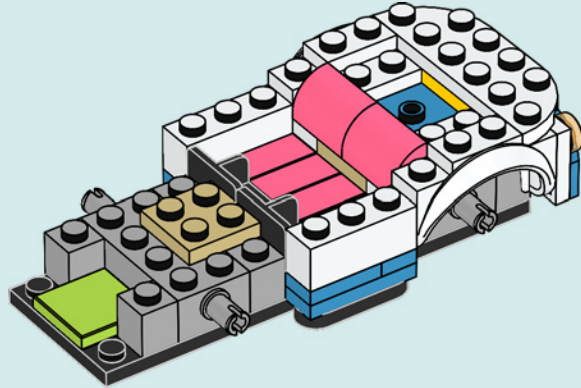



2x

21

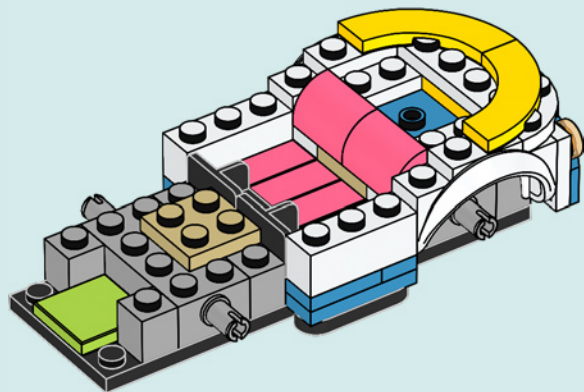

2x

22

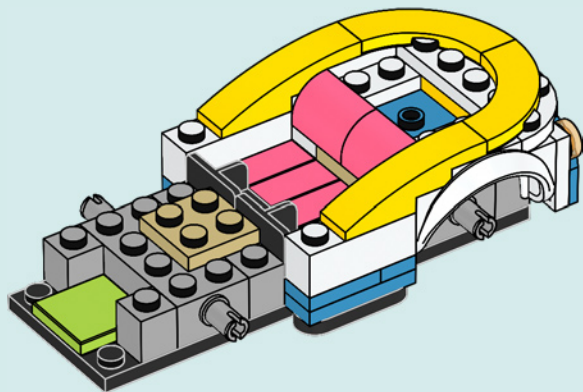



2x

23

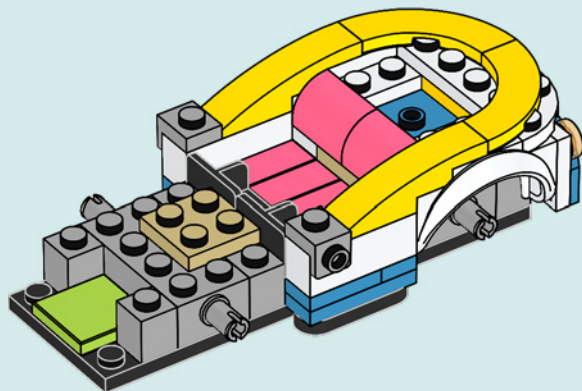



2x

24

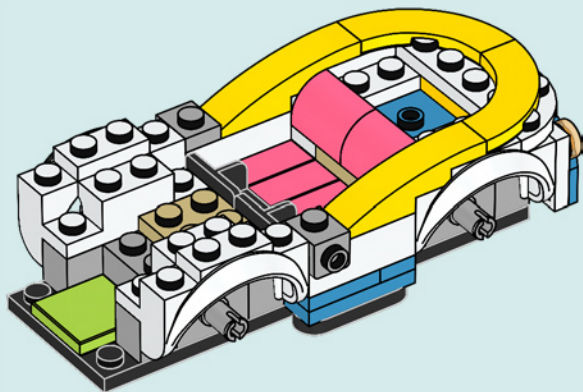

2x

25

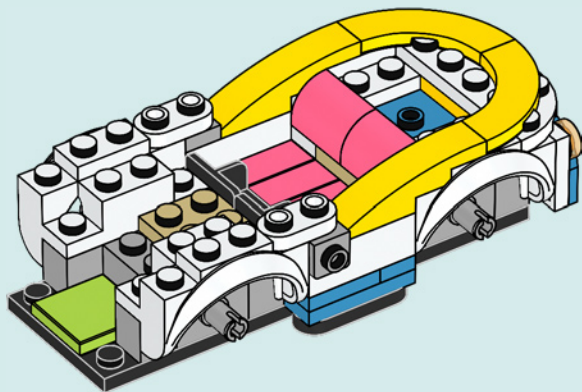



1x



1x

26

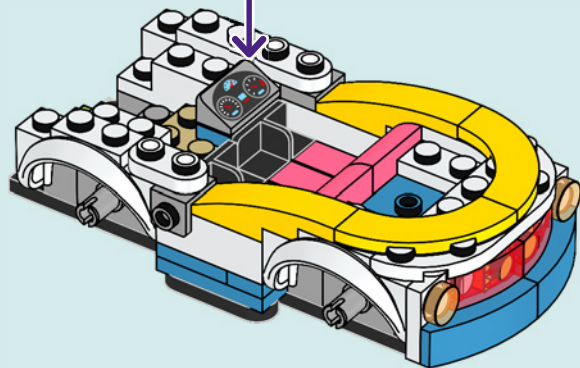
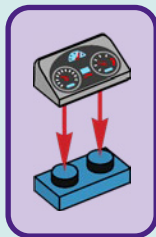



1x

27

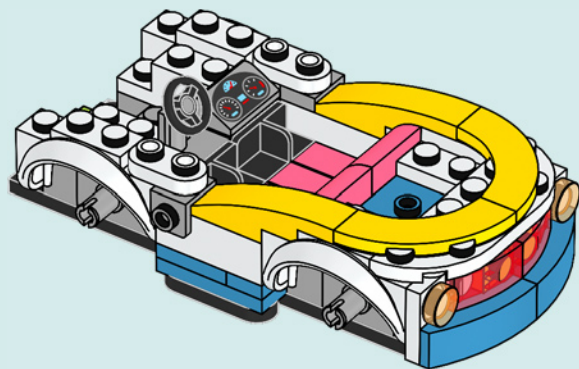



2x

28

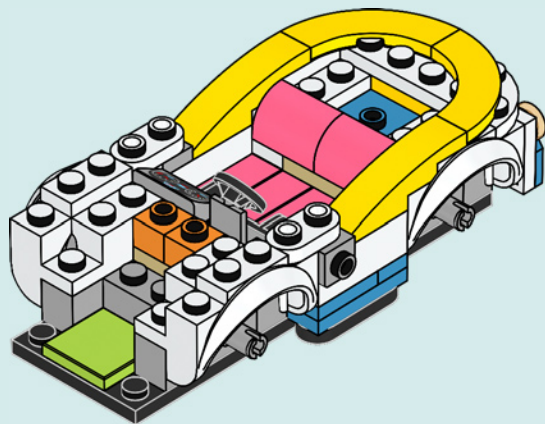



1x

29

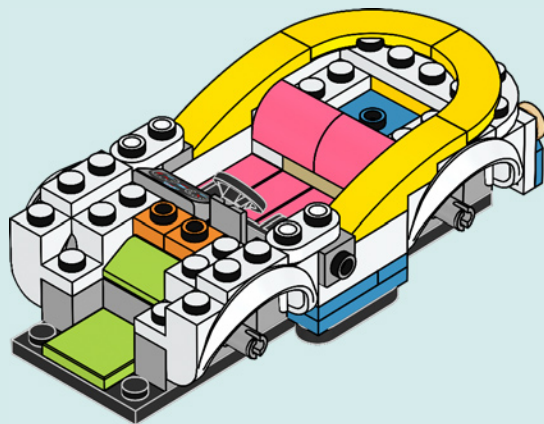



1x



2x

30

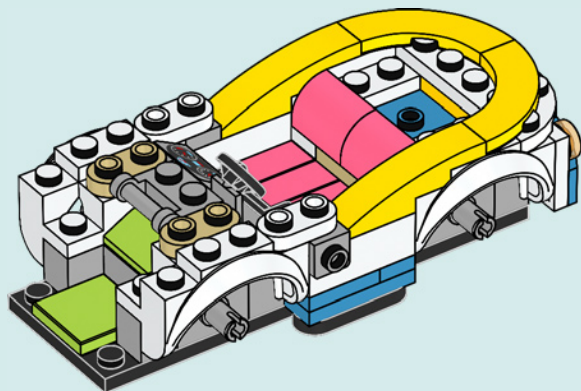



31

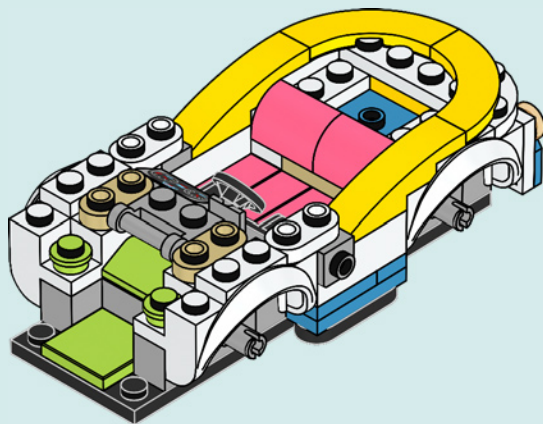



2x

32

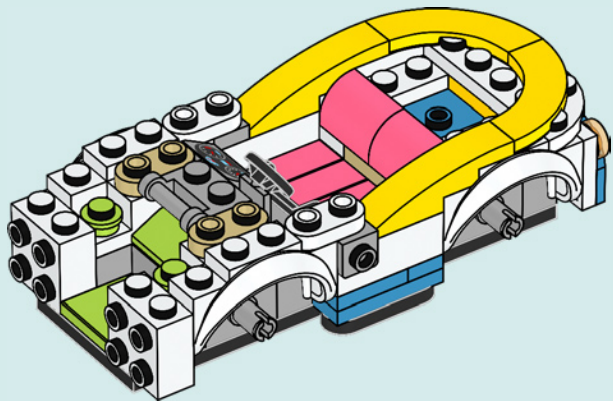



2x

33

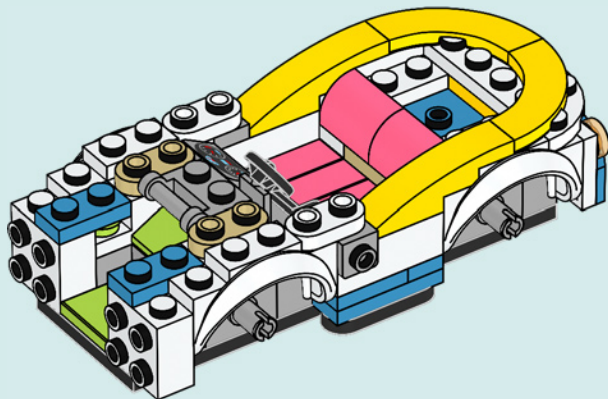



1x

34

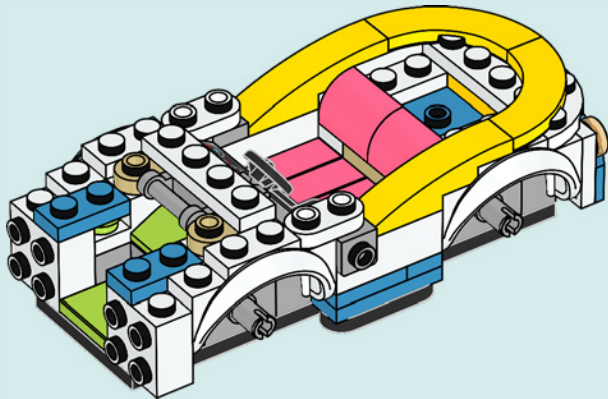



2x



2x

35

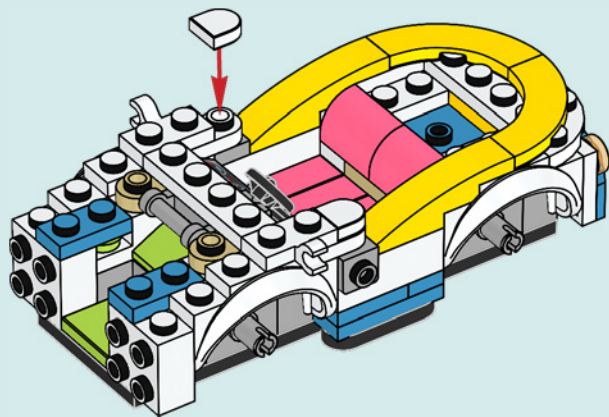

2x

36

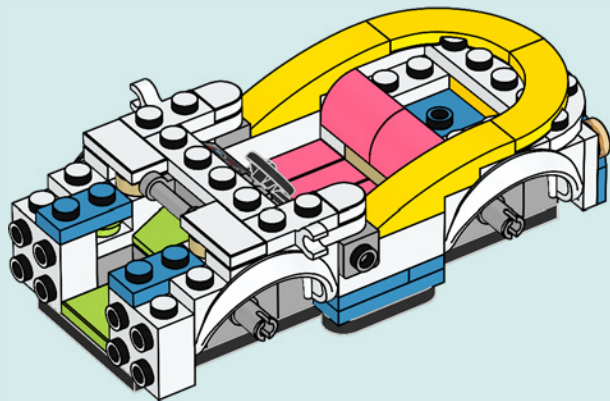



2x

37

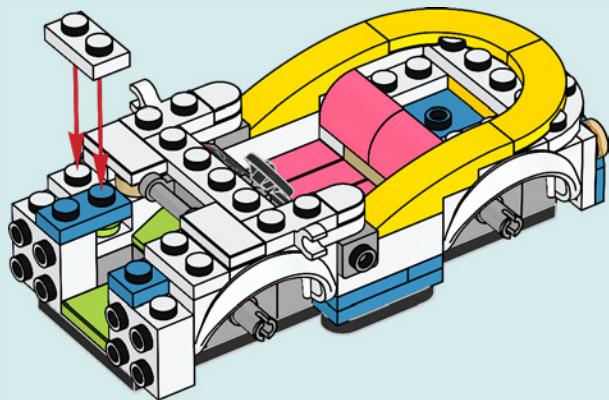



1x



2x

38

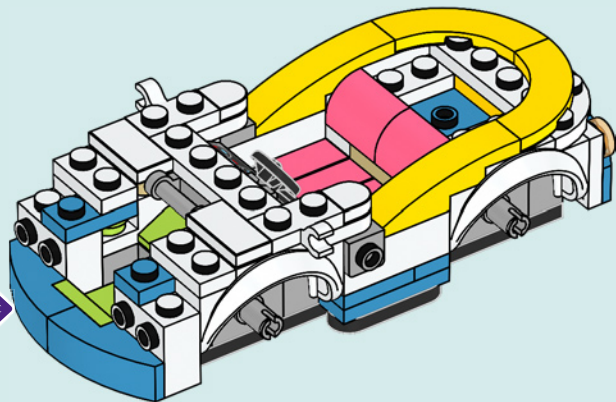
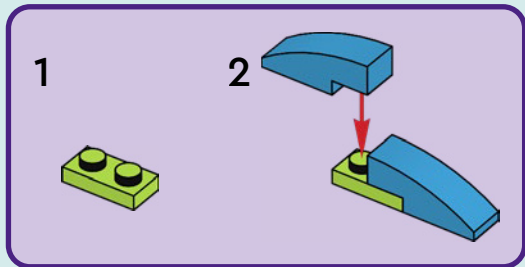

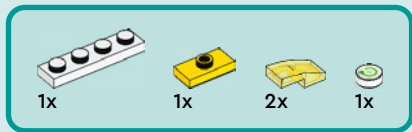

39

1

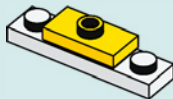

2

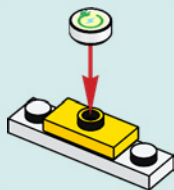

3



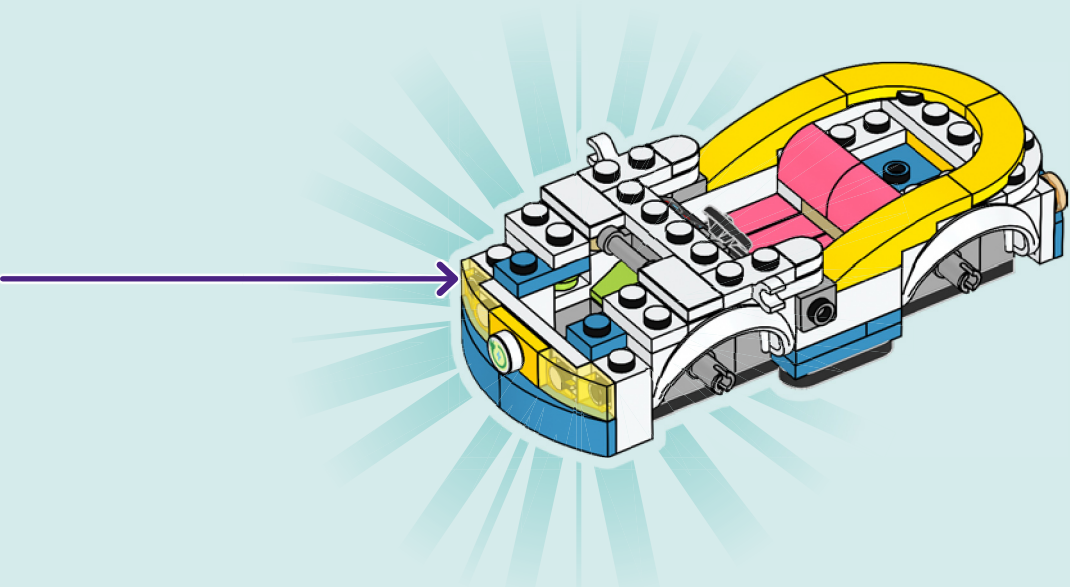

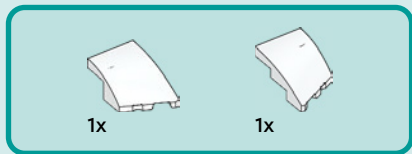

40

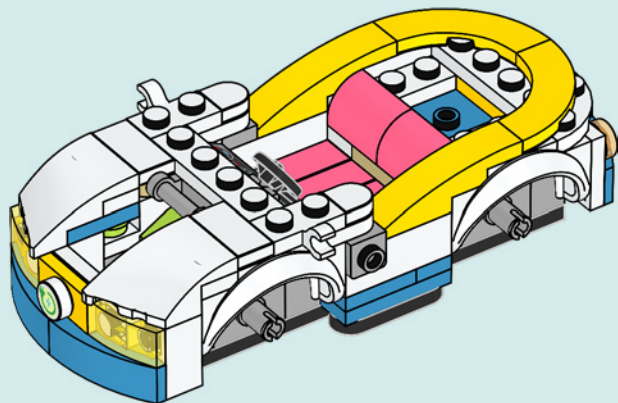

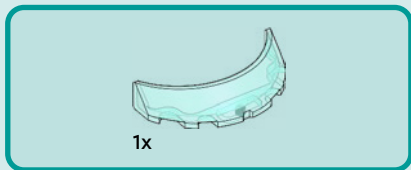

41

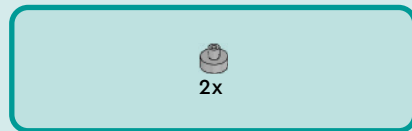
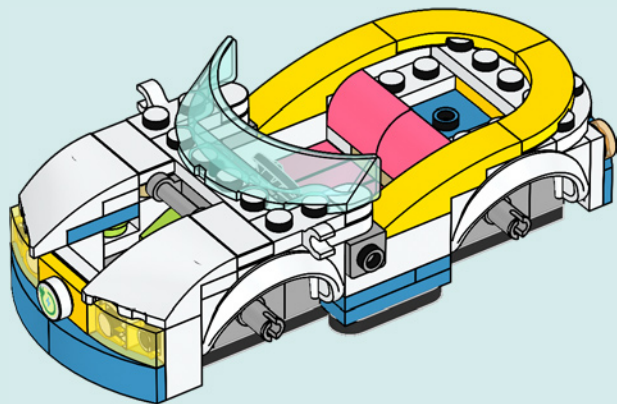

42

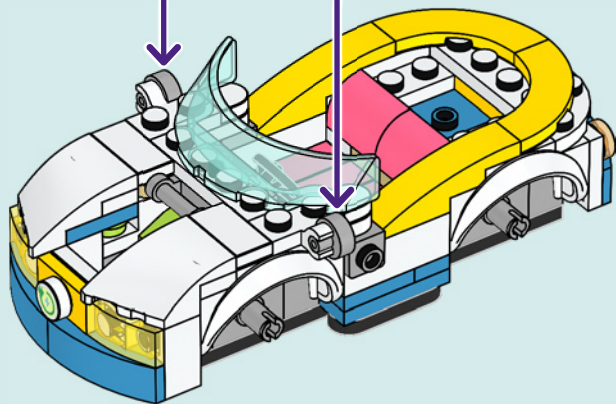



1x



1x



1x

43

1



2

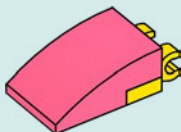

3

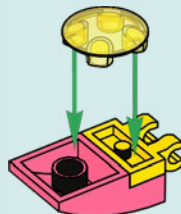

44

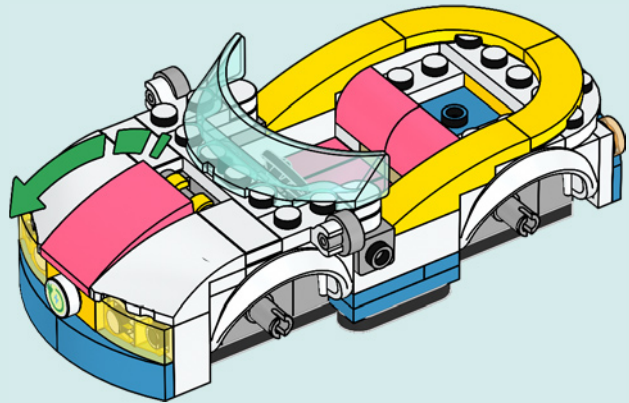
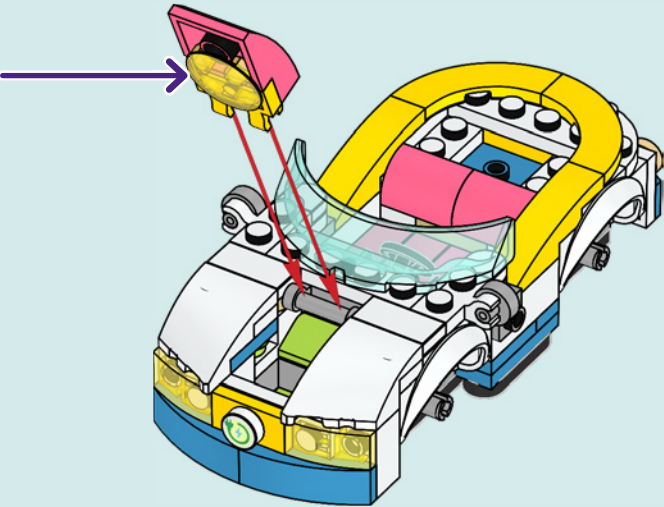

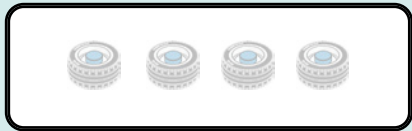

45

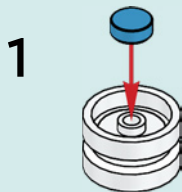

2

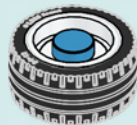

4x

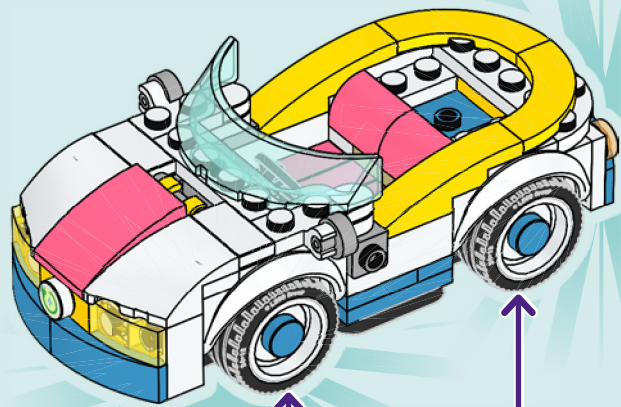

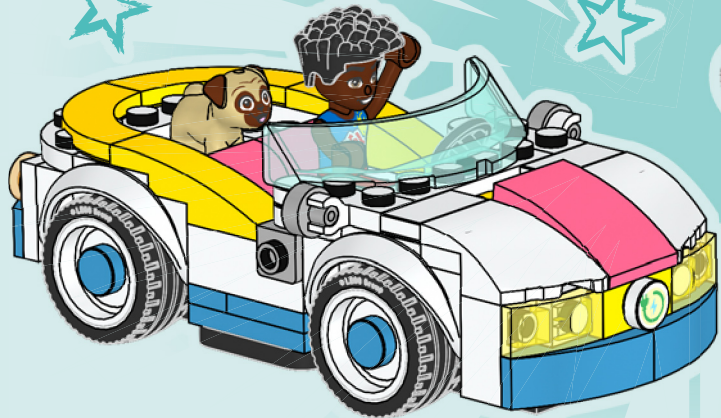



Friends

OLLY

ALIYA

NOVA

PAISLEY

LIANN

LEO

AUTUMN

ZAC



LEGO Friends





Friends

WATCH
SERIES
ONLINE



WATCH SERIES ONLINE / SCHAU DIR DIE SERIE ONLINE AN / REGARDE LA SÉRIE EN LIGNE / GUARDA LA SERIE ONLINE / MIRA LA SERIE EN INTERNET / ASSISTIR À SÉRIE ONLINE / 在线观看 /
OGLADAJ SERIAL W INTERNECIE / SLEDUJ SERIAL ONLINE / POZRI SI SERIAL ONLINE / NÉZD A SOROZATOT ONLINE / VIZIONEAZĂ SERIALUL ONLINE / ГЛЕДАЙТЕ СЕРИАЛА ОНЛАЙН /
SKATIES SĒRIĀLU TIĒŠSAISTĒ / VAATA SARJA VEEBIST / ŽIŪRĒK SĒRIALĀ INTERNETU

1x 6373413	2x 6218823	1x 6147792	1x 6054438	1x 6409770	2x 6229130	1x 6171728
2x 6250591	1x 6450820	1x 379501	1x 6429941	1x 6329698	2x 6411022	2x 6438778
2x 6210272	4x 6290262	2x 6212758	1x 6210269	2x 6115086	1x 6399478	2x 4183133
2x 4650644	1x 6407402	1x 6466188	1x 6313592	1x 4226995	1x 6378799	1x 6025026
2x 6284507	2x 362201	1x 6409761	1x 6092583	2x 6428168	1x 6424035	2x 6411328
1x 287701	1x 6407399	2x 6395373	1x 6337231	1x 4124096	2x 6468878	2x 4164037
1x 6383982	2x 371001	1x 6416619	1x 302224	4x 6102596	1x 6274739	1x 4220632
2x 6313115	2x 371001	1x 6416619	1x 6466834	1x 6327402	1x 6326099	1x 4518611
2x 306901	4x 6293776	1x 6429738	2x 6024715	1x 302926	1x 6246853	
2x 302301		2x 6382558	2x 6382558			

1x
6307452

4x
6442359

1x
6416593

1x
6430007

1x
4616711

2x
6274747

1x
6209681

1x
6416487

1x
6078605

1x
6439365

2x
6258831

1x
6326748

1x
6329583

8x
4211389

2x
6248078

1x
6329152

1x
6429052

1x
4211512

1x
4211469

1x
4244627

1x
4507056

2x
6356158

1x
4211395

1x
6354325

1x
6452523

1x
6287856

1x
6271752

1x
4210719

1x
6225494

1x
4567887

2x
4211042

4x
6322824

4x
4653988

1x
6029163

4x
4640901

2x
6144149

1x
6151657

1x
4640891

3x
4625032

2x
6258405

4x
6258566



2x
6261293

1x
6469809

 [LEGO.com/service](https://www.lego.com/service)

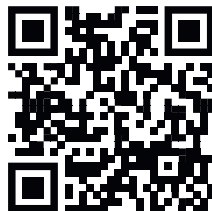

SHARE YOUR FEEDBACK



Scan this QR code or go to
LEGO.COM/PRODUCTFEEDBACK and give us
your short feedback about this LEGO® set.

Terms and Conditions apply*

EN: SHARE YOUR FEEDBACK. Terms and Conditions apply* **DE: Teile dein FEEDBACK.** Es gelten die Teilnahmebedingungen* **FR: Partagez vos COMMENTAIRES.** Des conditions s'appliquent* **IT: Condividi il tuo FEEDBACK.** Termini e condizioni sono applicabili* **ES: Comparte tu OPINIÓN.** Aplican términos y condiciones* **PT: Partilha o teu FEEDBACK.** Aplicam-se termos e condições* **ZH: 请分享您的反馈。条款和条件适用*** **PL: Podziel się swoją OPINIĄ.** Obowiązują warunki korzystania* **CS: Podělte se o ZPĚTNOU VAZBU.** Platí všeobecné smluvní podmínky* **SK: Podel' sa o svoj NÁZOR.** Platia všeobecné zmluvné podmienky* **HU: Oszd meg a VÉLEMÉNYED.** Felhasználási feltételek érvényesek* **RO: Trimite FEEDBACK.** Se aplică termenii și condiții* **BG: Споделете вашите ОТЗИВИ.** Има определени правила и условия* **LV: Sniedziet ATSAUKSMES.** Ir spēkā noteikumi un nosacījumi.* **ET: Jaga oma TAGASISIDET.** Kehtivad tingimused* **LT: Palikite ATSILIEPIMĄ.** Taikomos sąlygos*
*LEGO.com/productfeedback-terms

LEGO, the LEGO logo and the FRIENDS logo are trademarks of the LEGO Group.
©2024 The LEGO Group.

6495177