



Booklet available in English on  
Heft in deutscher Sprache erhältlich auf  
Livret disponible en français sur  
Libretto disponibile in italiano su  
Folleto en español disponible en  
如需中文版手册, 请访问



FR

**DONNEZ  
OU  
RECYCLEZ**



ASSOCIATION  
OU



MAGASIN  
OU



DÉCHÈTERIE

Adresses sur [quefairemesdechets.fr](http://quefairemesdechets.fr)



[LEGO.com/sustainable-packaging](http://LEGO.com/sustainable-packaging)

# LEGO® VIP

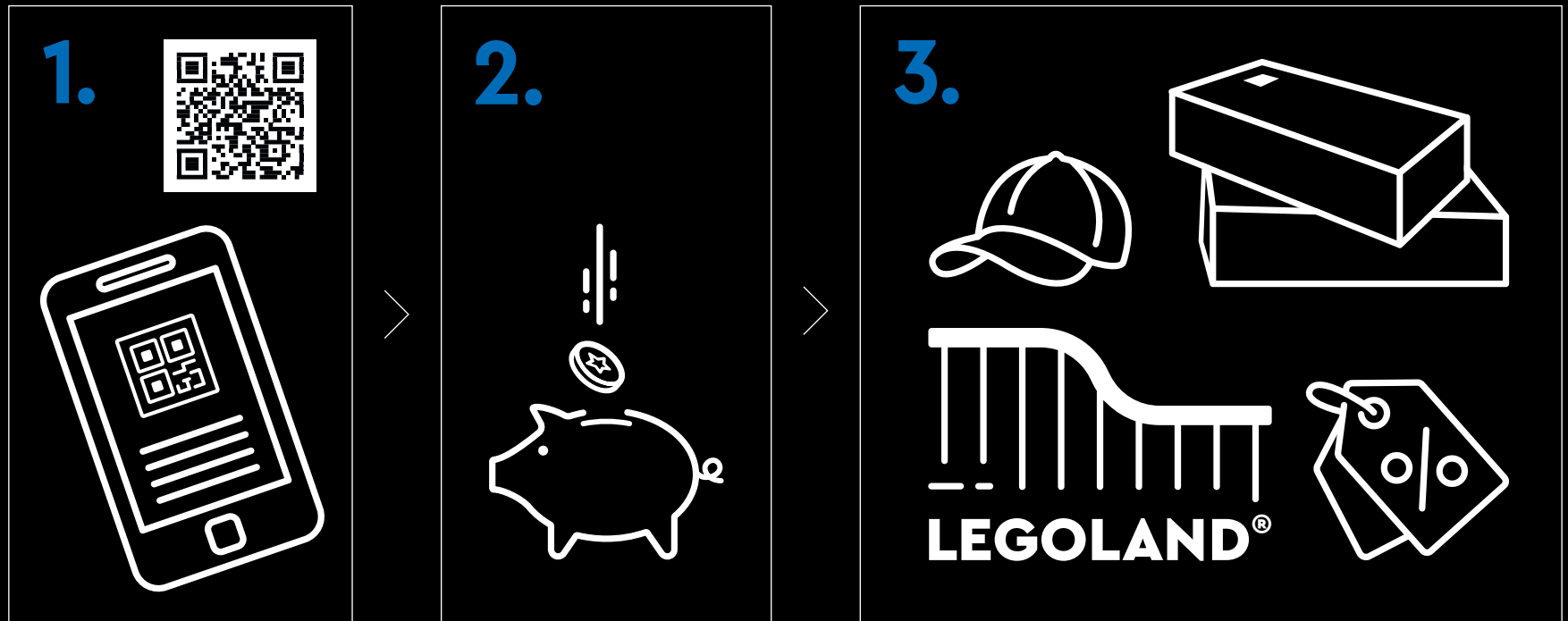

**1.** Sign up **2.** Earn points for purchases **3.** Redeem points for rewards, experiences, discounts & more | **1.** Melde dich an **2.** Sammle Punkte bei jedem Kauf **3.** Löse die Punkte für Belohnungen, Erlebnisse, Rabatte und Ähnliches ein | **1.** Inscrivez-vous **2.** Gagnez des points lors de vos achats **3.** Échangez vos points contre des récompenses, des expériences, des remises et bien plus encore | **1.** Iscriviti **2.** Guadagna punti con i tuoi acquisti **3.** Riscatta punti per premi, esperienze, sconti e altro ancora | **1.** Regístrate **2.** Gana puntos por tus compras **3.** Canjea puntos por recompensas, experiencias, descuentos y mucho más | **1.** Registe-se **2.** Ganhe pontos em compras **3.** Troque os pontos para prémios, experiências, descontos e muito mais | **1.** 注册 **2.** 购物赚积分 **3.** 用积分兑换奖励、体验、折扣等 | **1.** Zarejestruj się **2.** Zdobywaj punkty za zakupy **3.** Wymieniaj punkty na rabaty, przygody i inne nagrody | **1.** Zaregistrujte se **2.** Sbírejte body za nákupy **3.** Vyměňujte body za odměny, zážitky, slevy a spoustu dalšího | **1.** Zaregistrujte se **2.** Získavajte body za nákupy **3.** Uplatnite si body a získajte odmeny, rôzne zážitky, zľavy a ešte viac | **1.** Regisztrálj **2.** Szerez pontokat minden vásárlással **3.** Váltsd be pontjaidat jutalmakra, élményekre, kedvezményekre és egyebekre | **1.** Înscric-te **2.** Câștigă puncte pentru achiziții **3.** Valorifică puncte pentru recompense, experiențe, reduceri și multe altele | **1.** Регистрируйте се **2.** Получайте точки за покупки **3.** Используйте точки за награды, услуги, отстъпки и т.н. | **1.** Reģistrējies **2.** Pelni punktus par pirkumiem **3.** Izmanto punktus, lai saņemtu balvas, izklaides iespējas, atlaides un daudz ko citu | **1.** Registreeru **2.** Teeni ostude eest punkte **3.** Lunasta punktide eest preemiad, elamused, allahindlused ja muu | **1.** Užsiregistruokite **2.** Pelnykite taškų už pirkinius **3.** Panaudokite taškus atlygiui, funkcijoms, nuolaidoms ir ne tik











# 姫路城

## HIMEJI CASTLE / THE CASTLE OF THE WHITE HERON

🌸 Majestically overlooking the Japanese city of Himeji, the breath-taking Himeji Castle is an architectural gem on UNESCO's World Heritage list. First built as a fortress in 1333, towards the end of an era of civil wars, the castle has undergone several transformations over the centuries. In 1600 a major reconstruction began, resulting in the current structure which has been preserved in its integrity until today, initially by feudal masters and later by the Japanese government. Mazes of intricate pathways once designed to confuse and trap enemies now weave an intriguing journey for visitors. Through wars, earthquakes, fires and times of peace, the Castle of the White Heron stands as a serene monument to Japanese culture. Discover the intricate details of the Main Keep and the history of the castle as you build.

---

**CHRIS MCVEIGH**  
*LEGO® Senior Designer*

## A TRIBUTE TO A REVERED LANDMARK

🍷 '2023 marks the 30<sup>th</sup> anniversary of Himeji Castle's inscription to UNESCO's World Heritage list, and its architecture and history are still like a mystery to decode. We created the Main Keep as a natural focal point and played with proportions and scales to make it stand out. If you have visited the castle you may recognise some of the interiors, and if you haven't seen it in person, we hope it sparks your imagination and curiosity.'





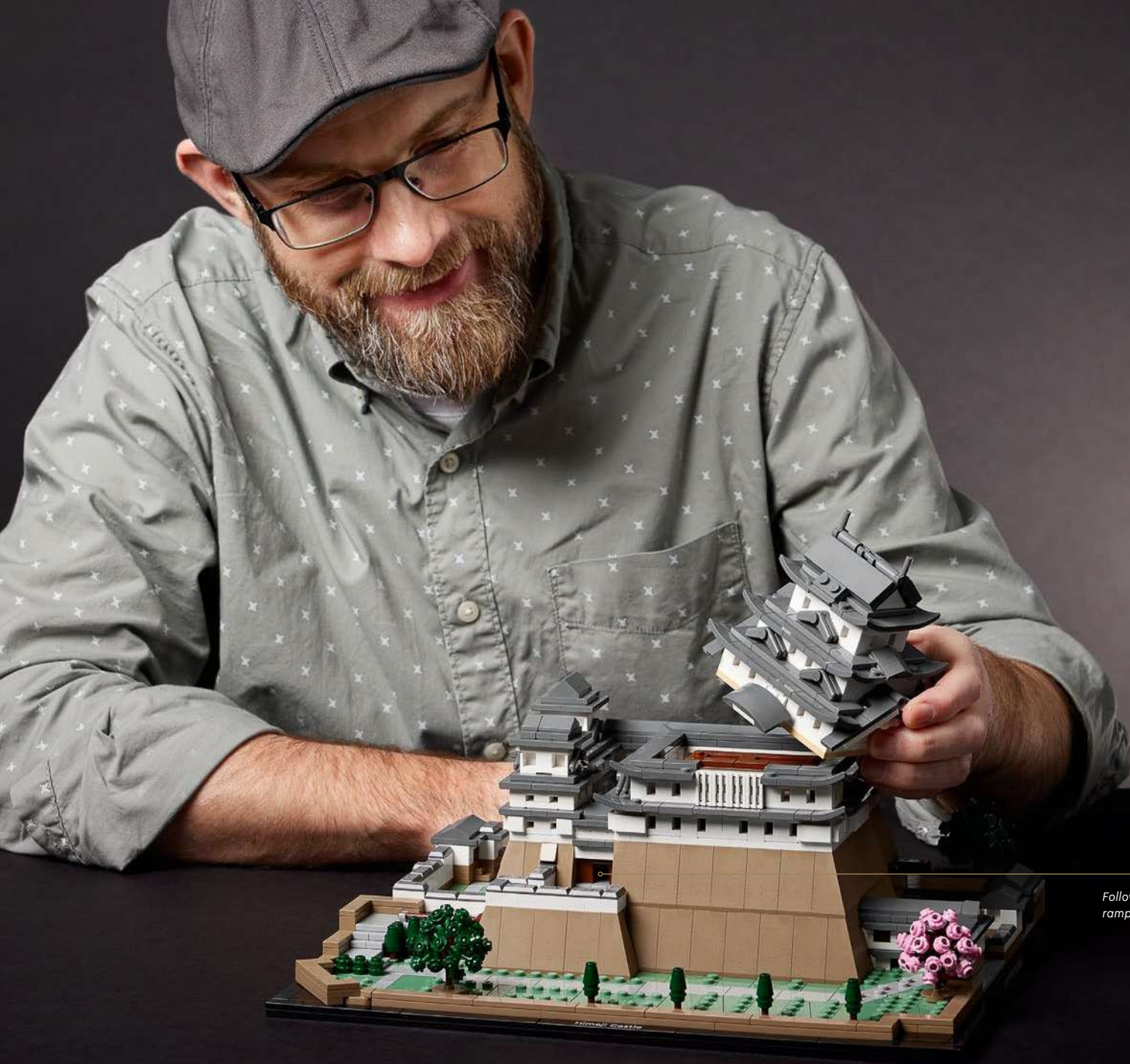

*Follow some of the intricate pathways, ramps and stairways through the castle.*



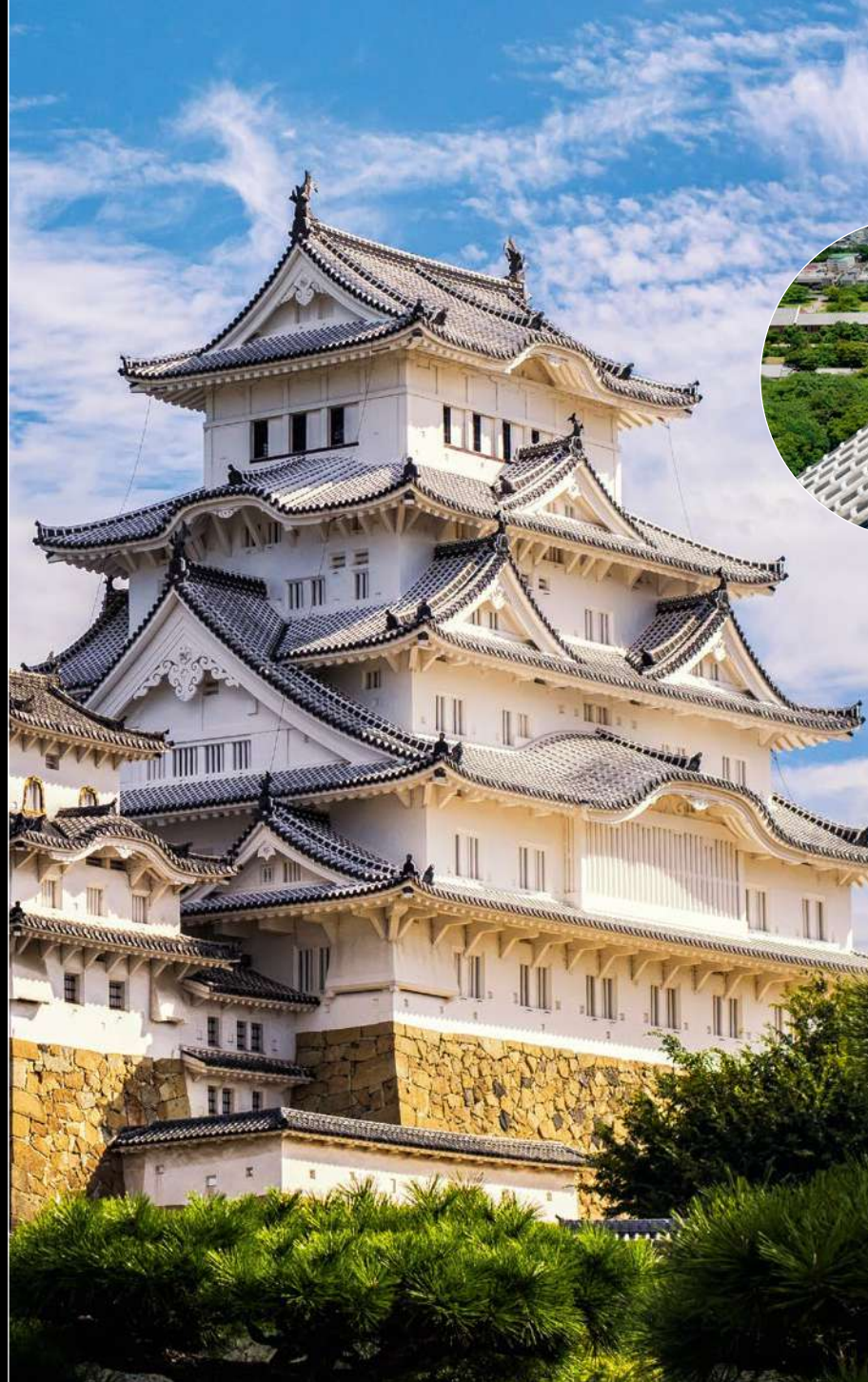

## AN OPTICAL ILLUSION

🍷 Himeji Castle's roofing method uses interlocking black rectangular and semi-circular tiles. Several layers of white clay line the tiles, giving the roofing a high-contrast, mesh-like appearance up close. However, at a distance, the mesh pattern appears grey. The roof tiles in this set are *Dark Stone Grey* to reflect the aging of the tiles.





*Peek inside after the model is built.*



*Each tower is constructed differently - even their heights.*

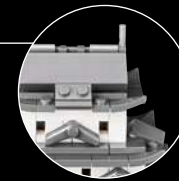

*A mesh of black tiles and white clay makes the roof appear grey from a distance.*

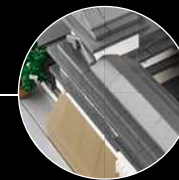

*Each layer or floor in the Main Keep evokes the actual structure of the castle.*



*Irregular angles are predominant throughout the castle and walls.*



*Decorate the cherry trees with pink blossoms or green leaves.*



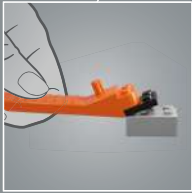
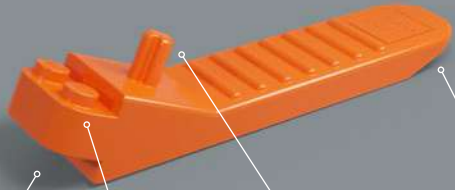



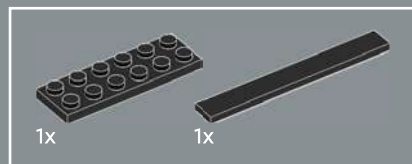

1

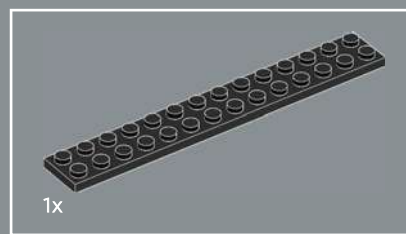
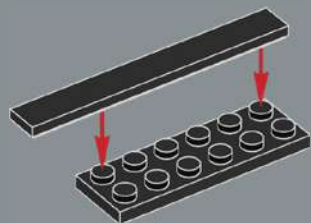

2

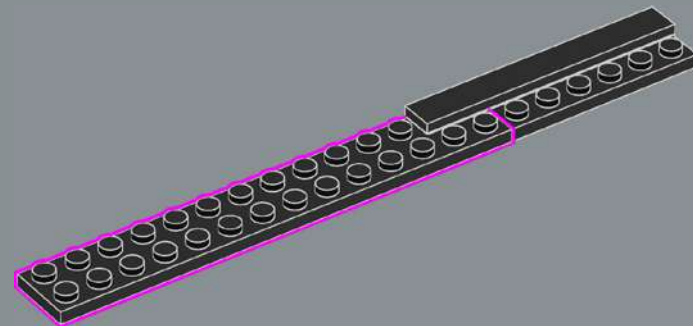

3

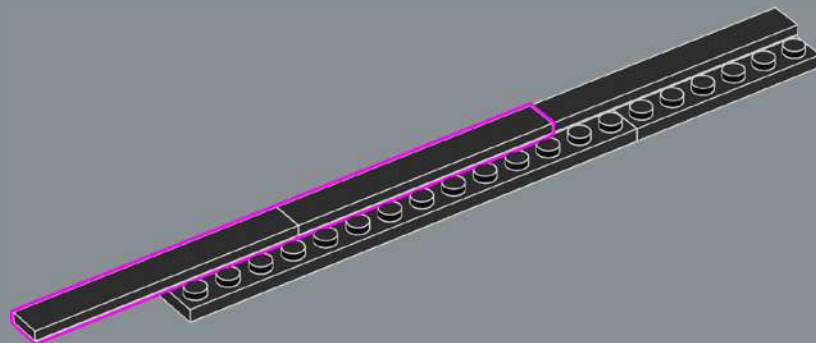

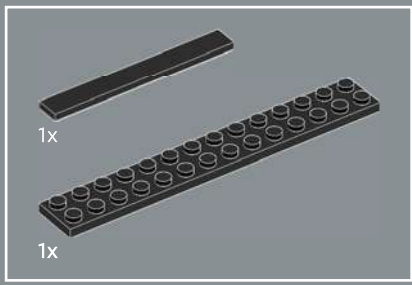

4

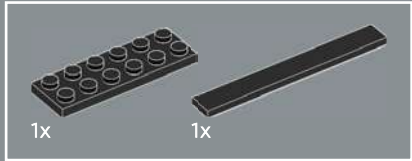
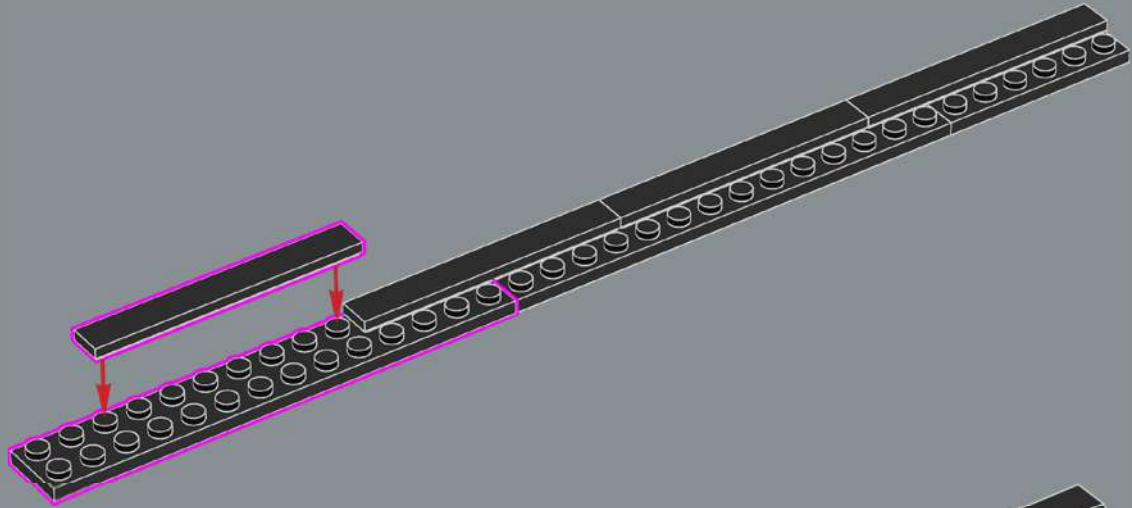

5

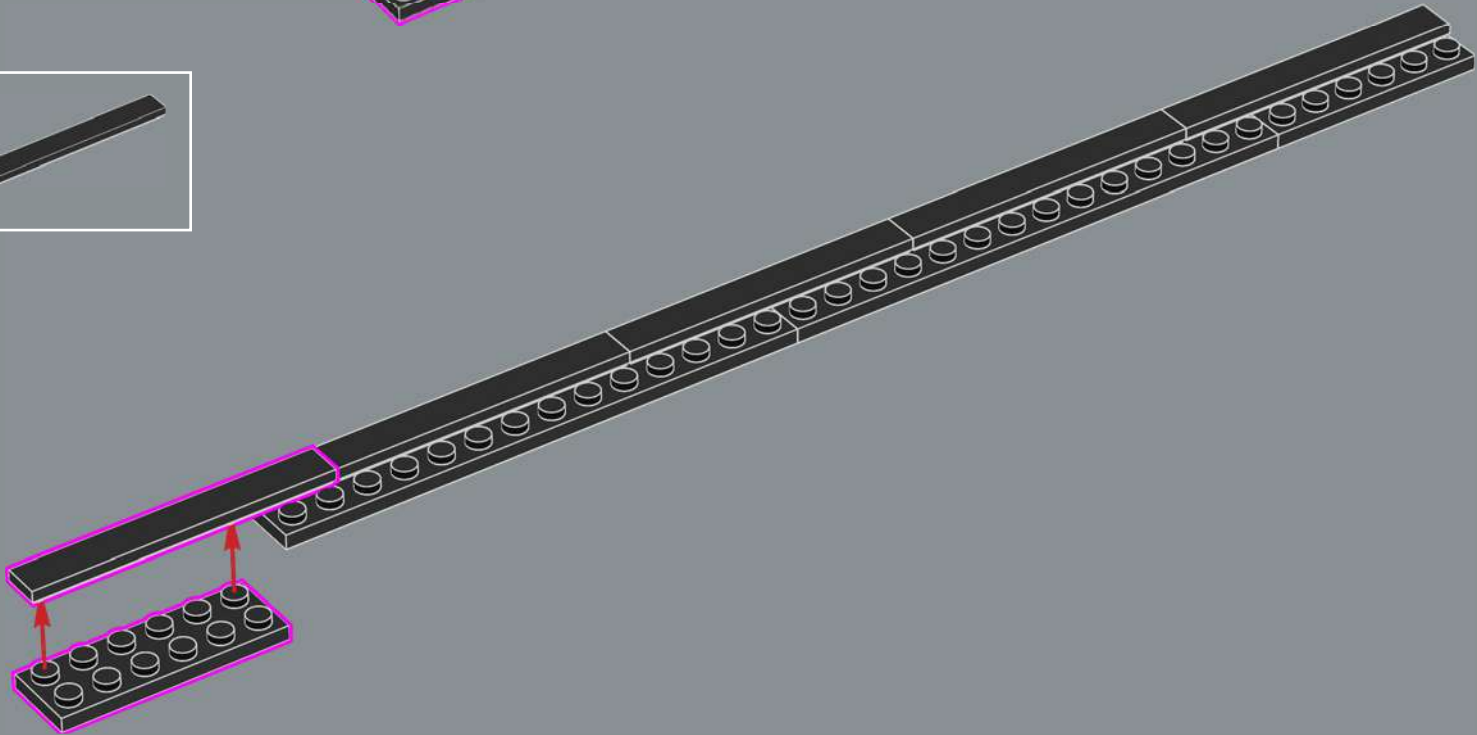



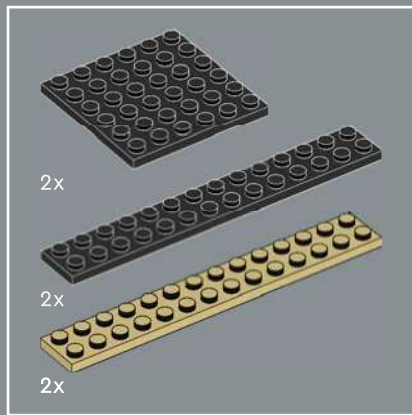

6

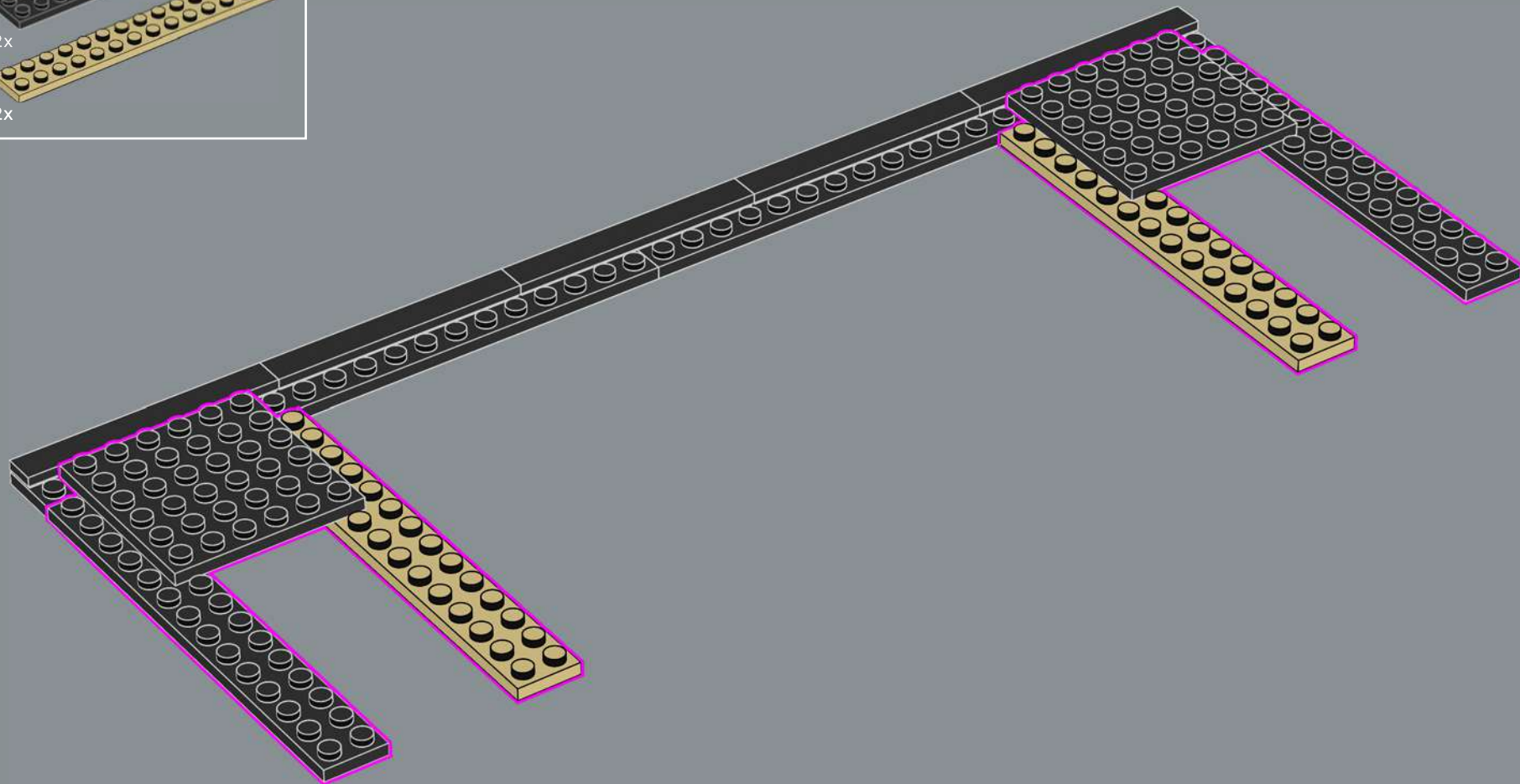

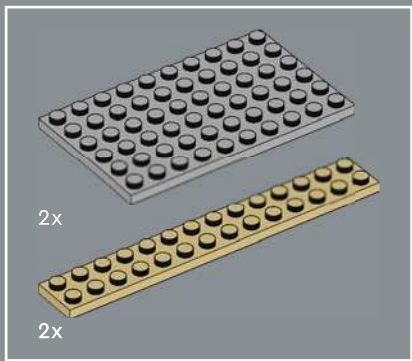

7

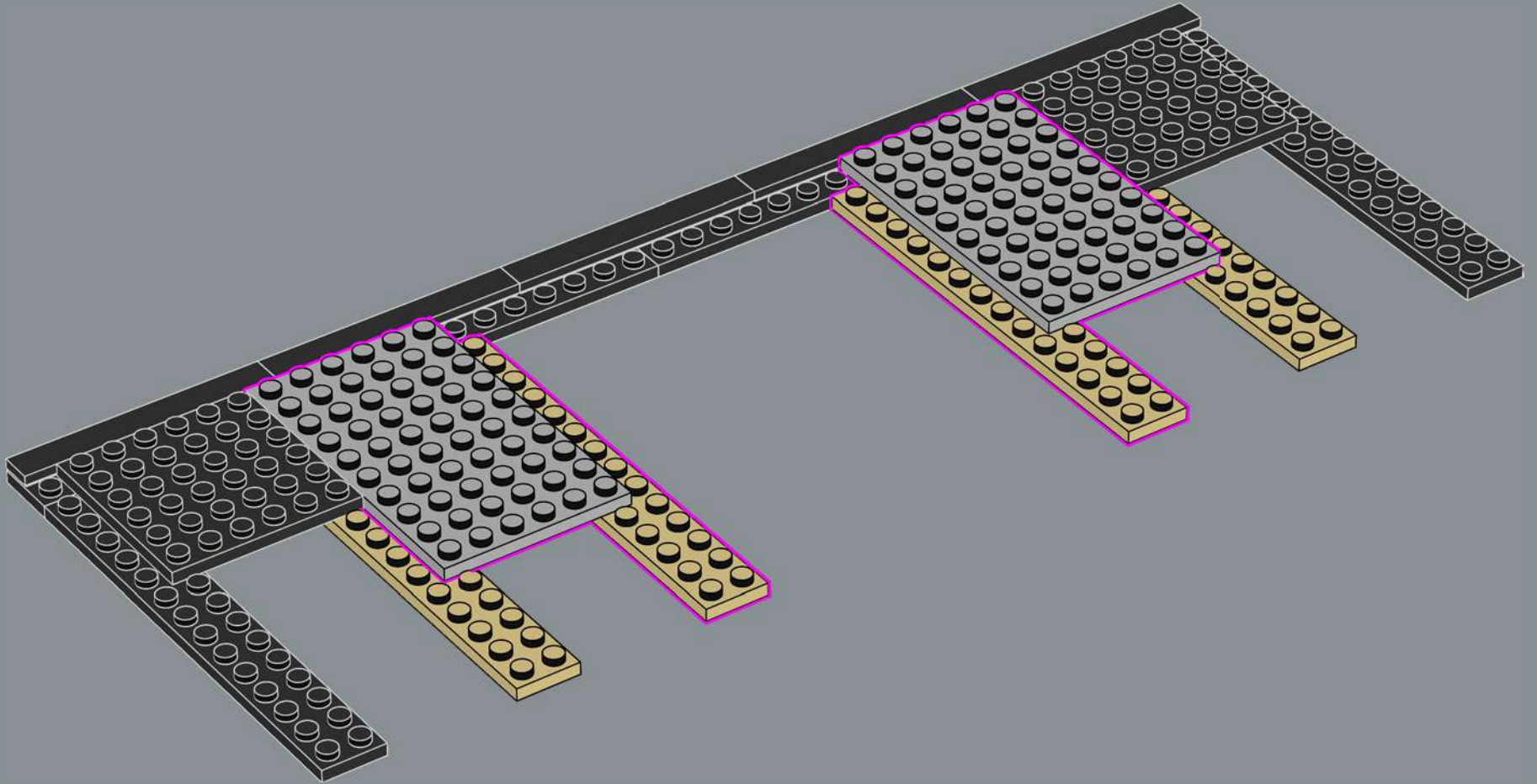

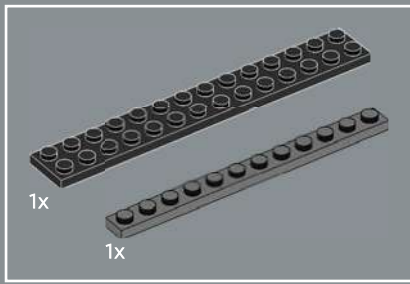

8

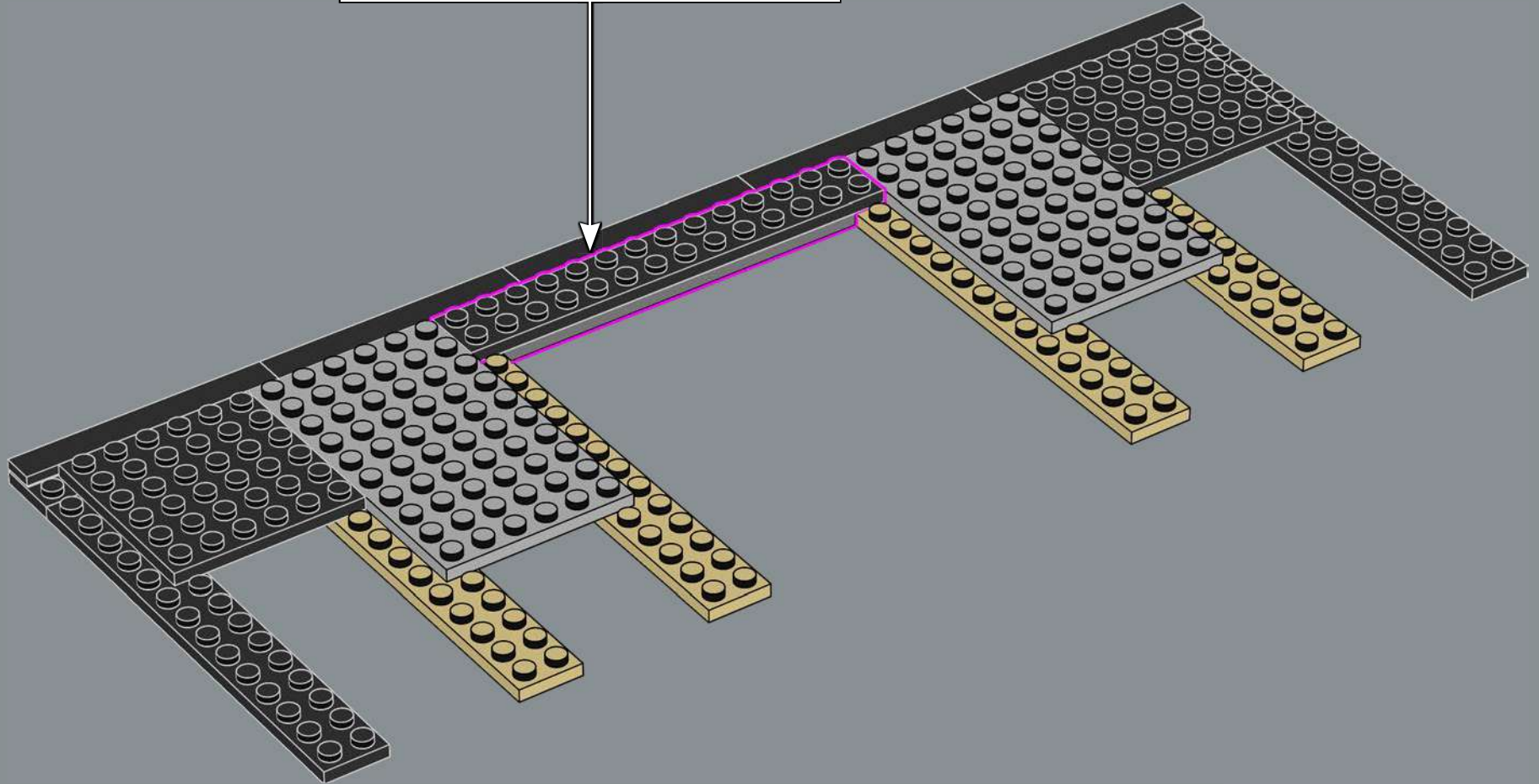
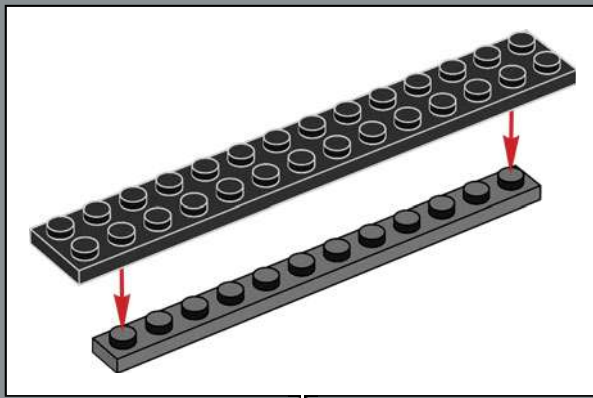



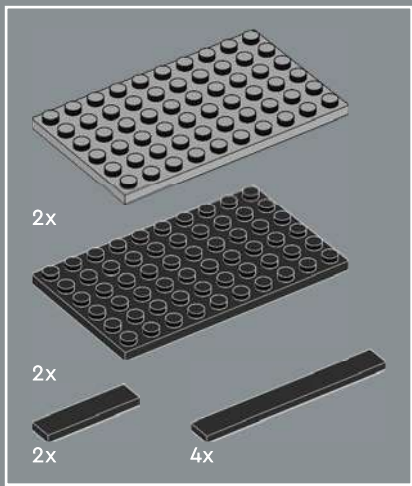

9

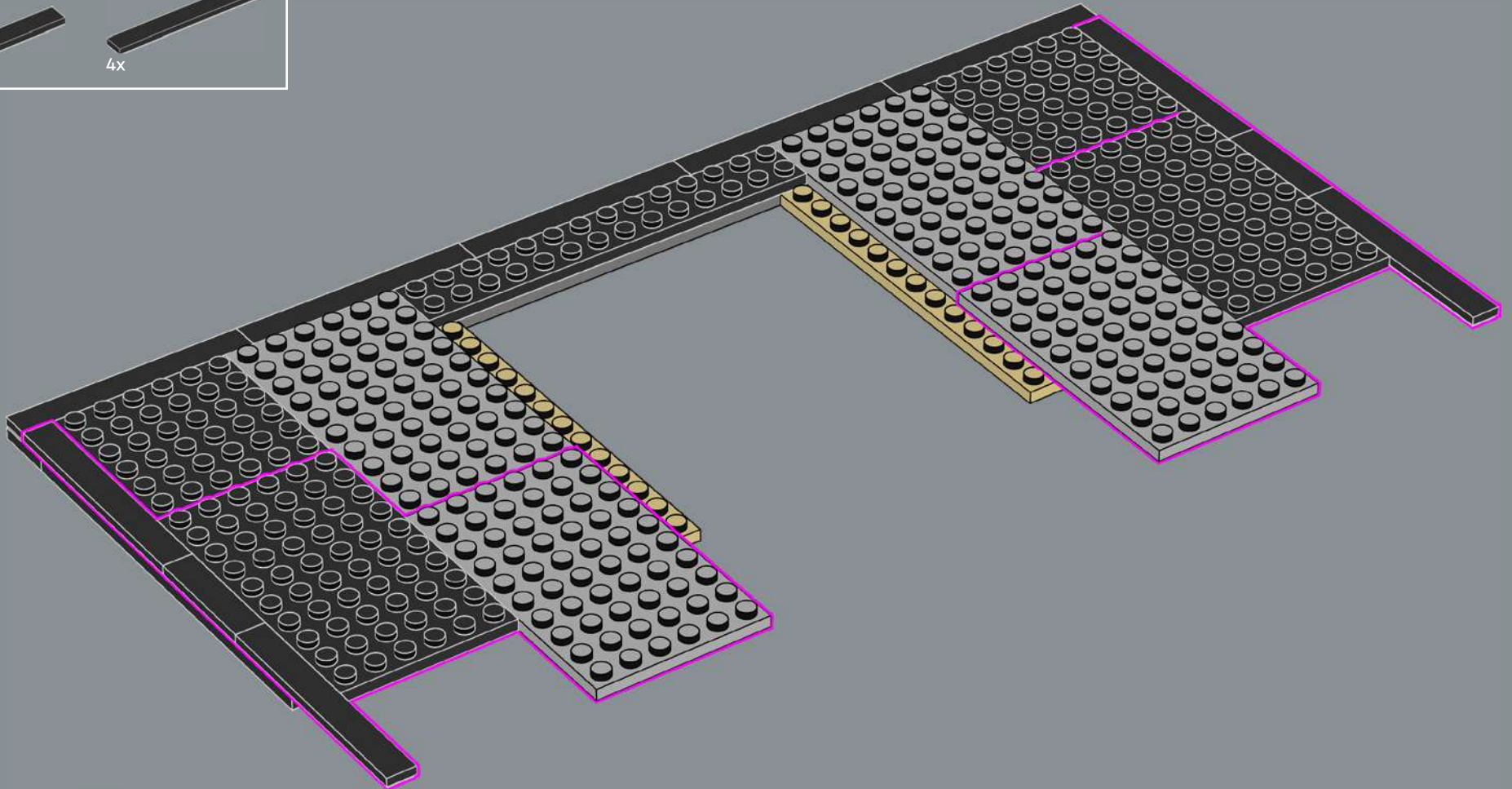



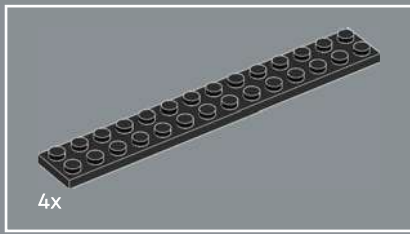

10

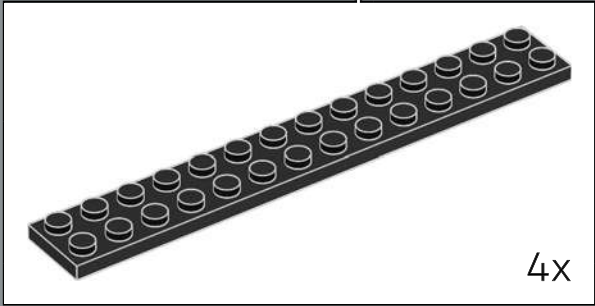
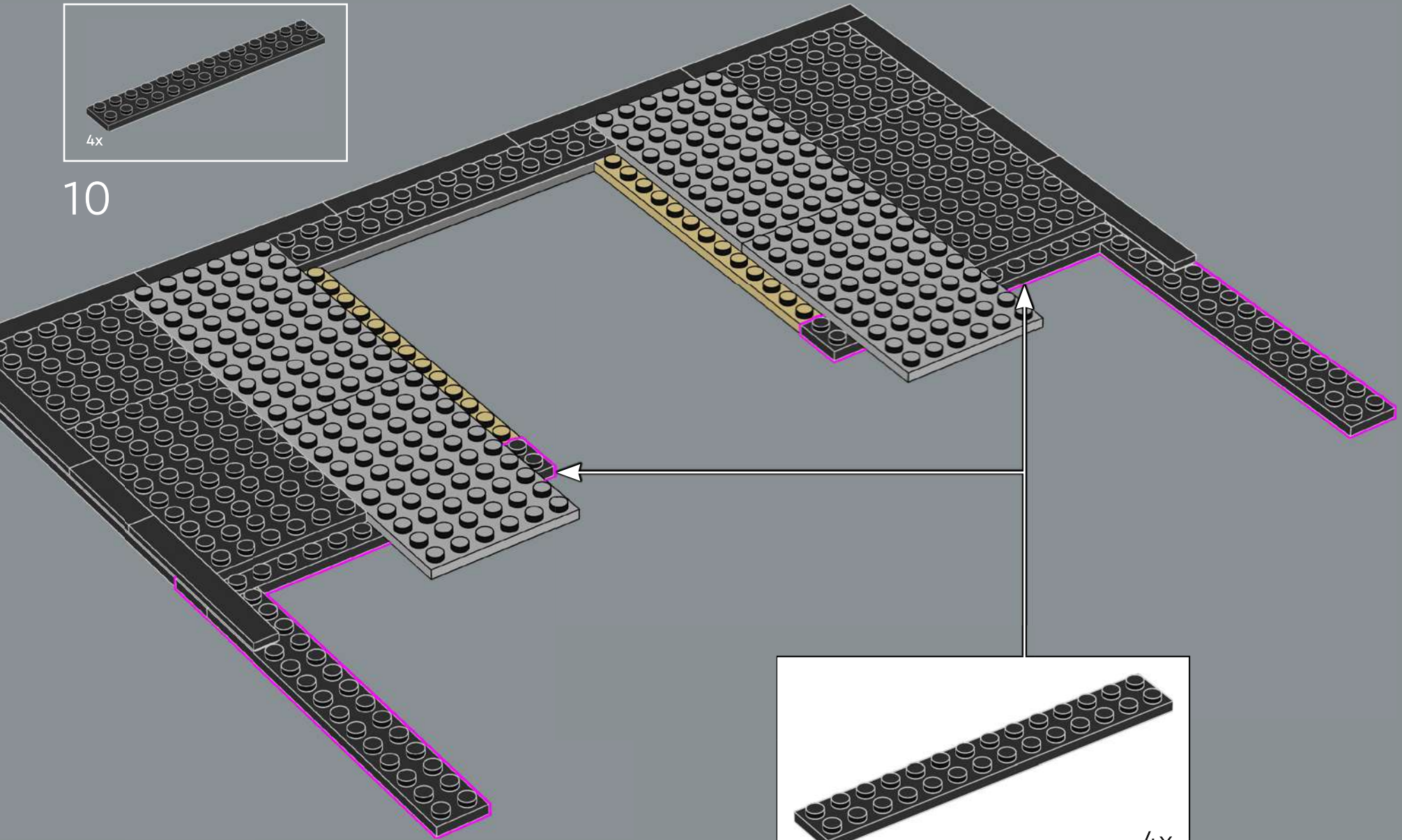

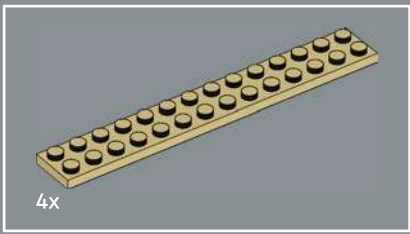

11

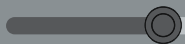
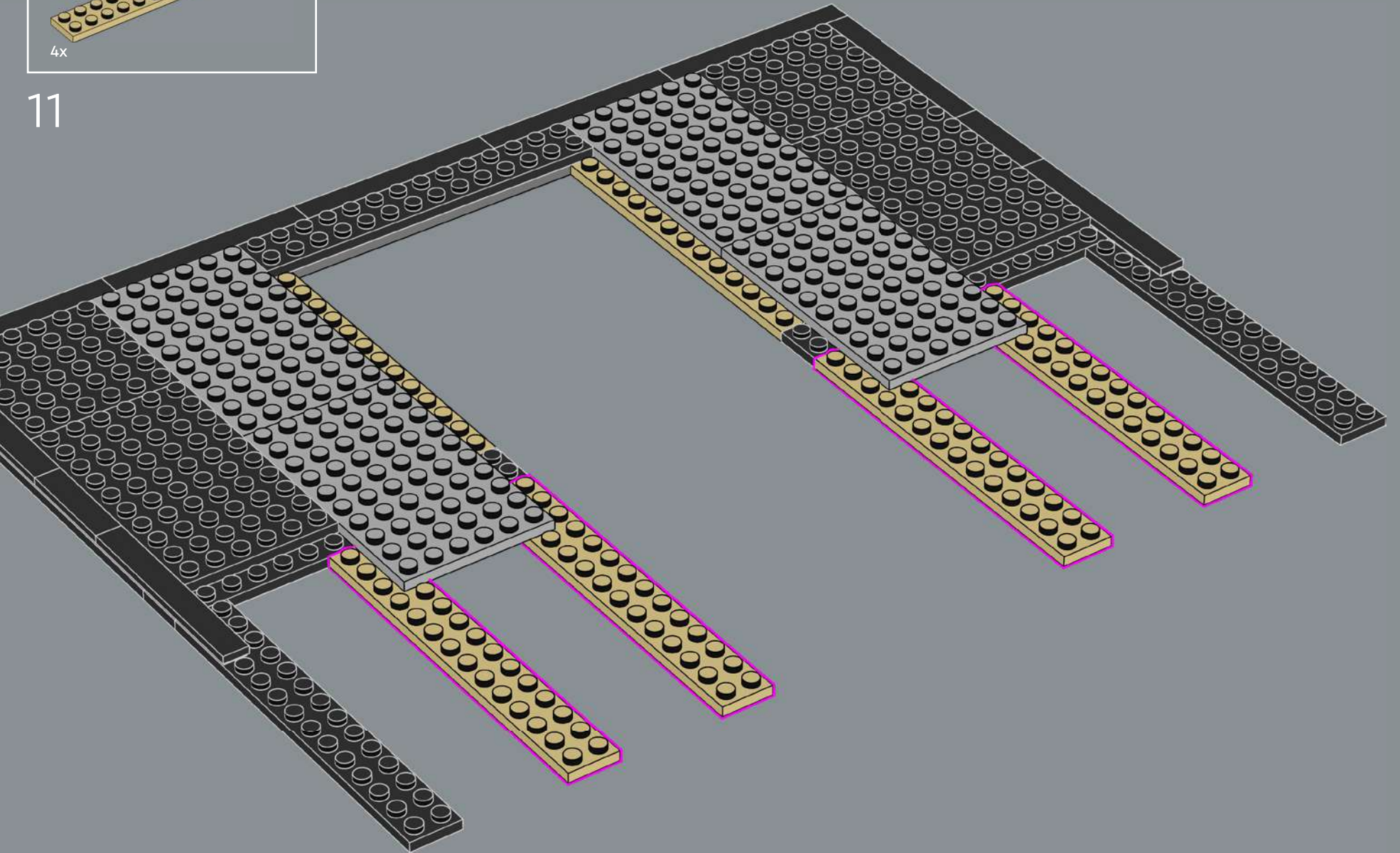



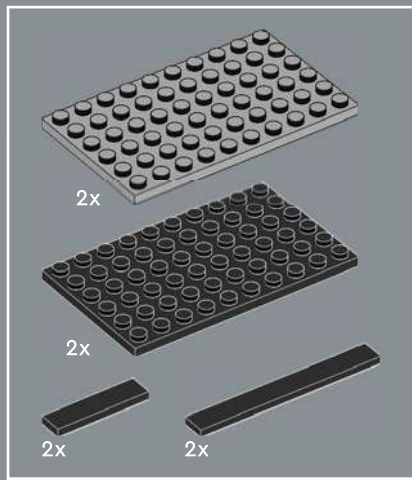

12

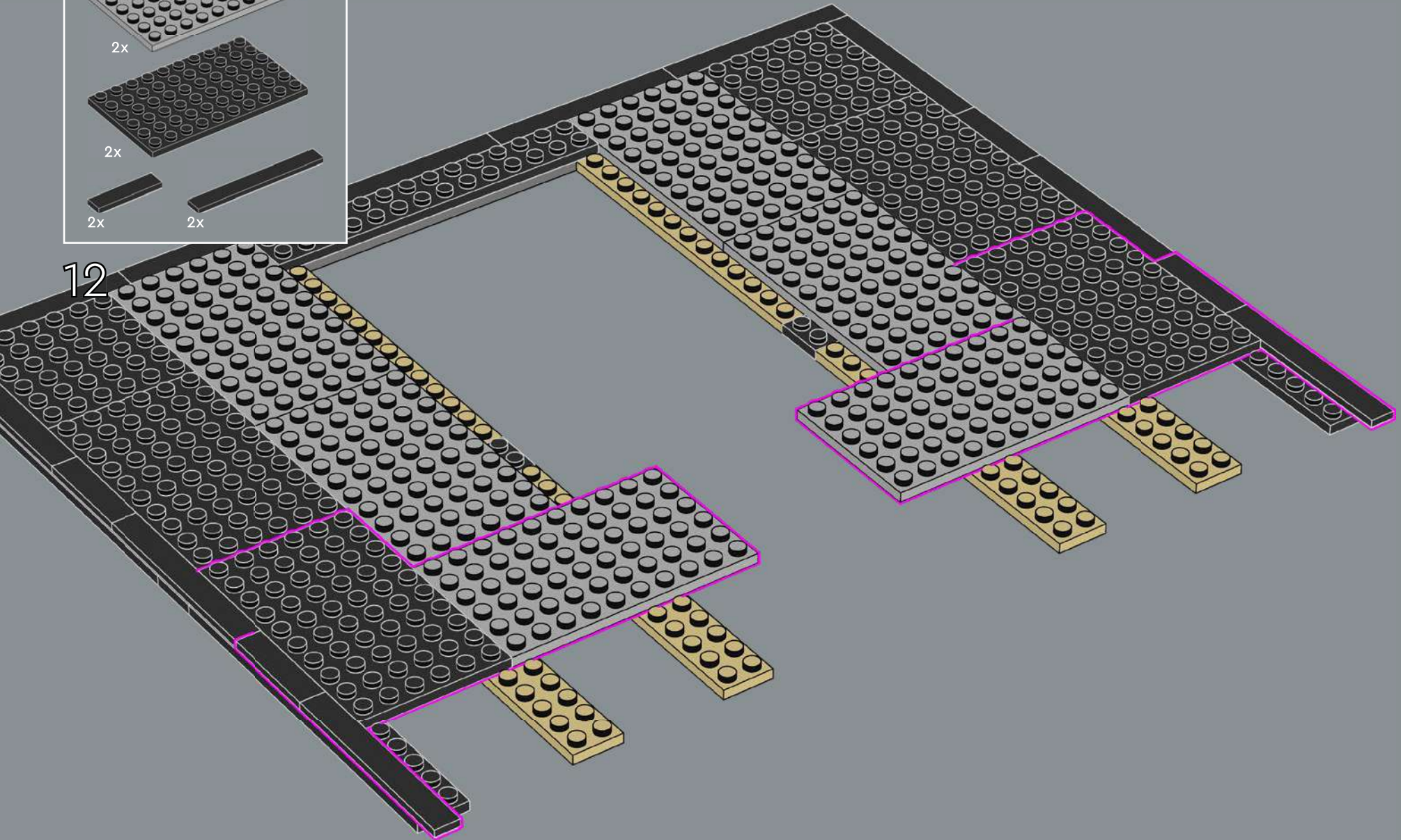

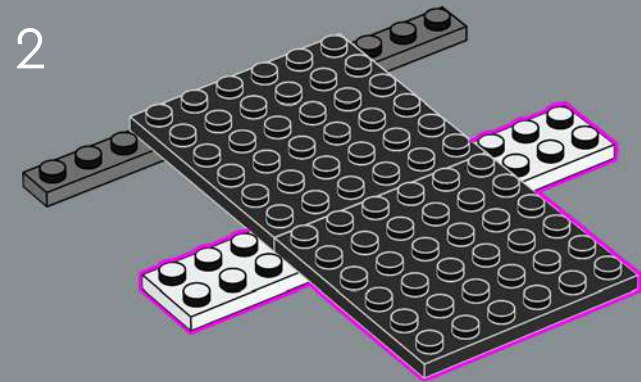
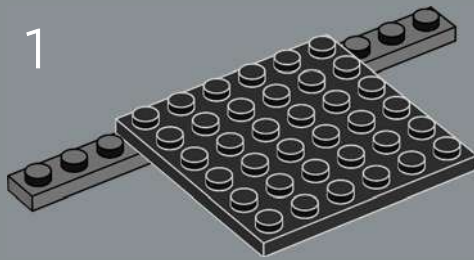
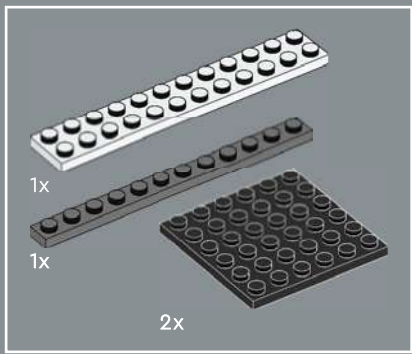

13

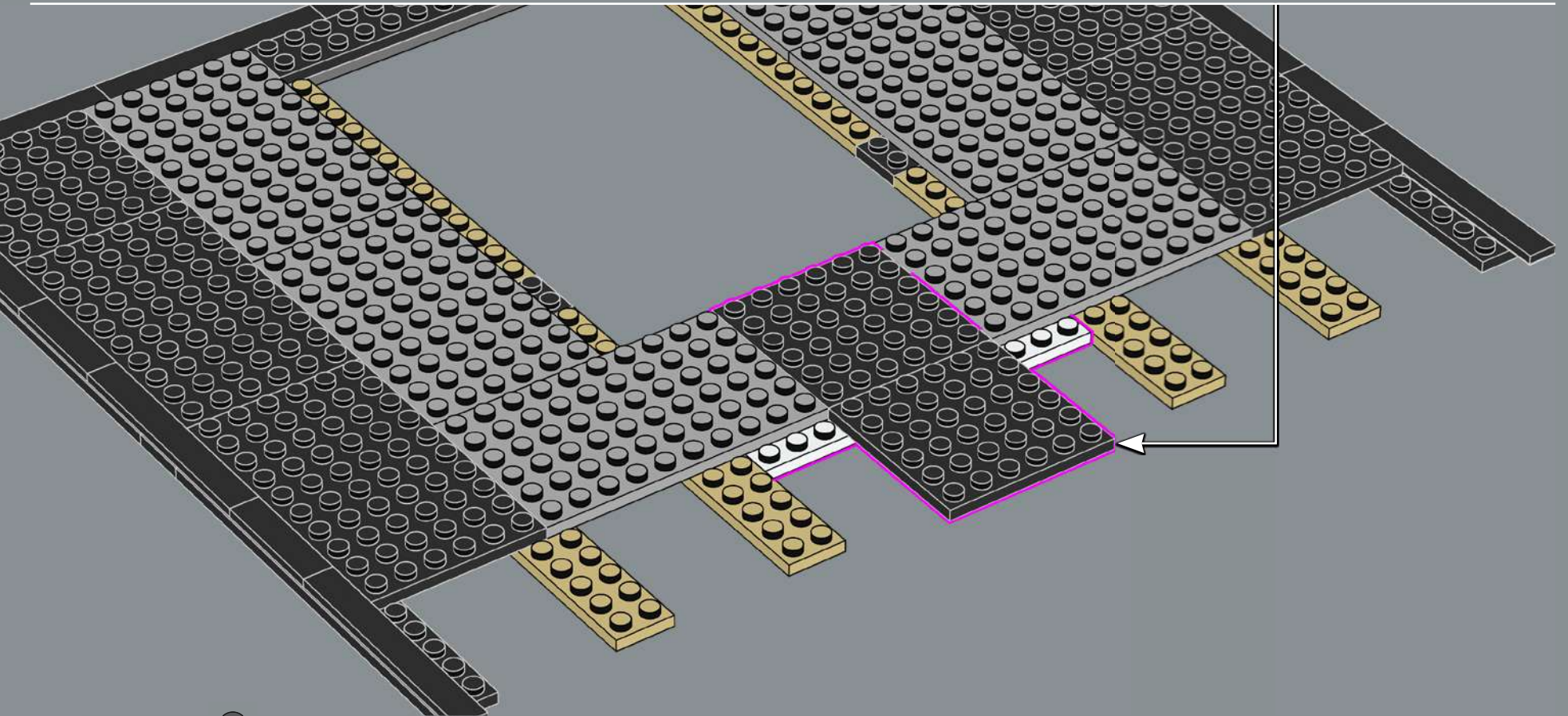





14

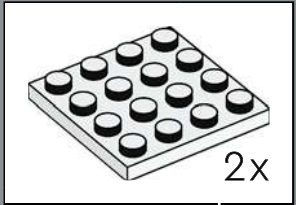
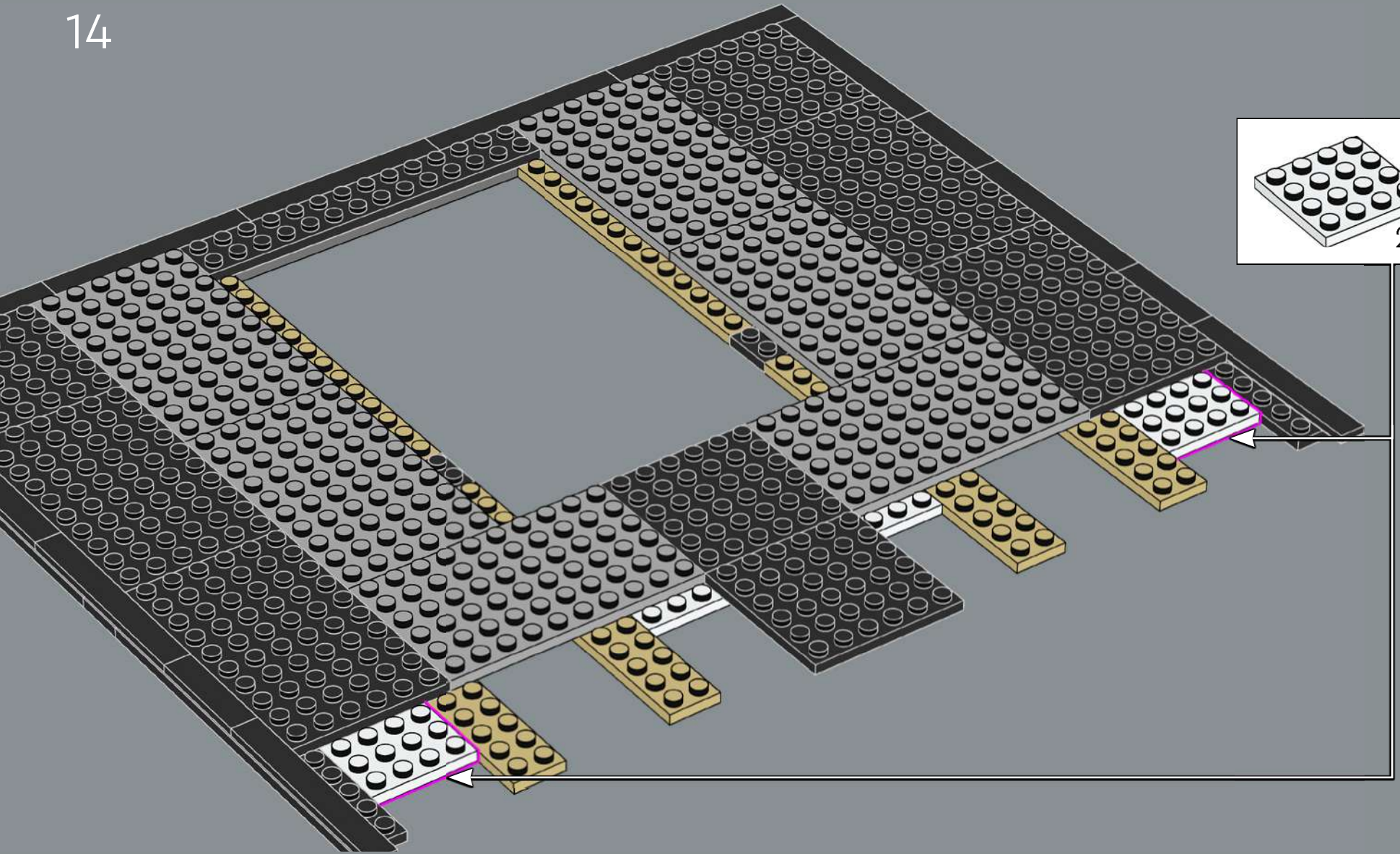

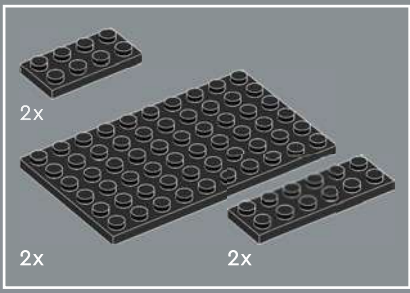

15

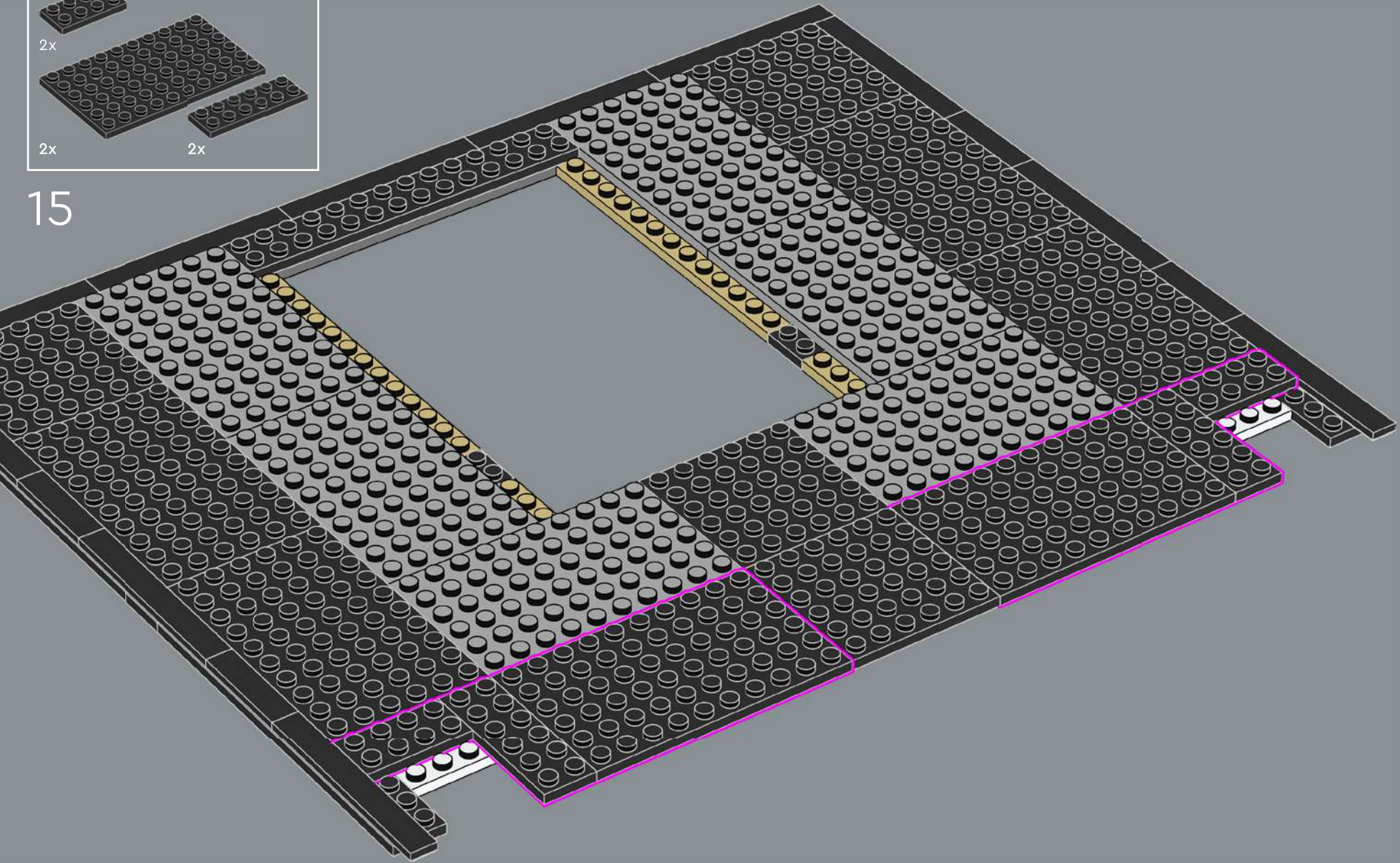



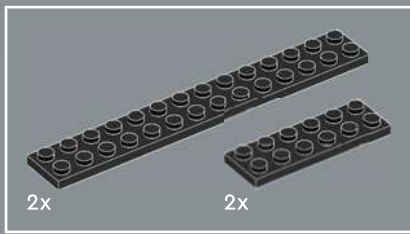

16

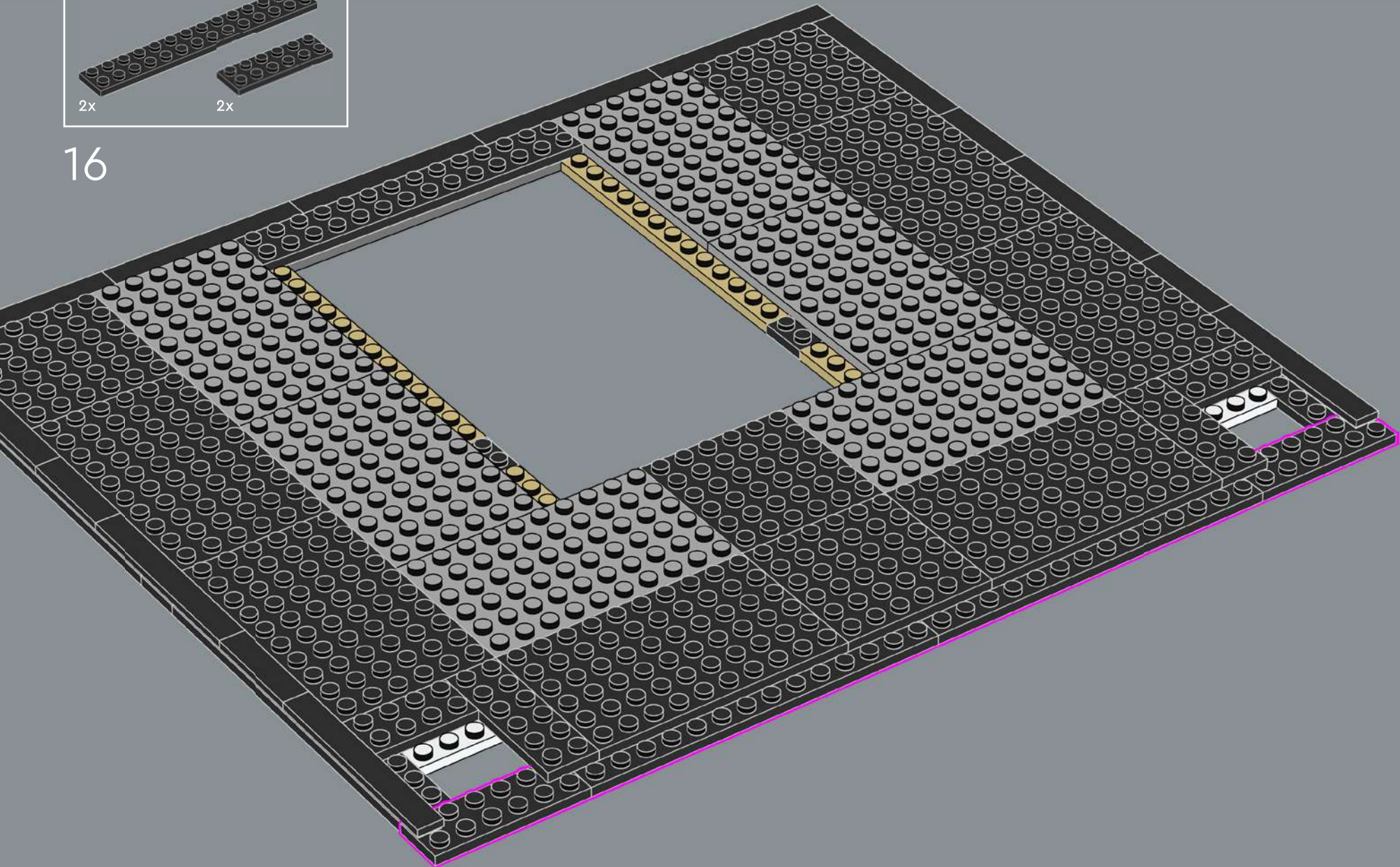



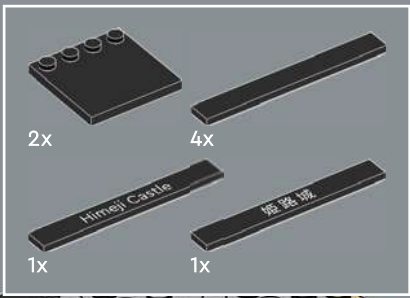

17

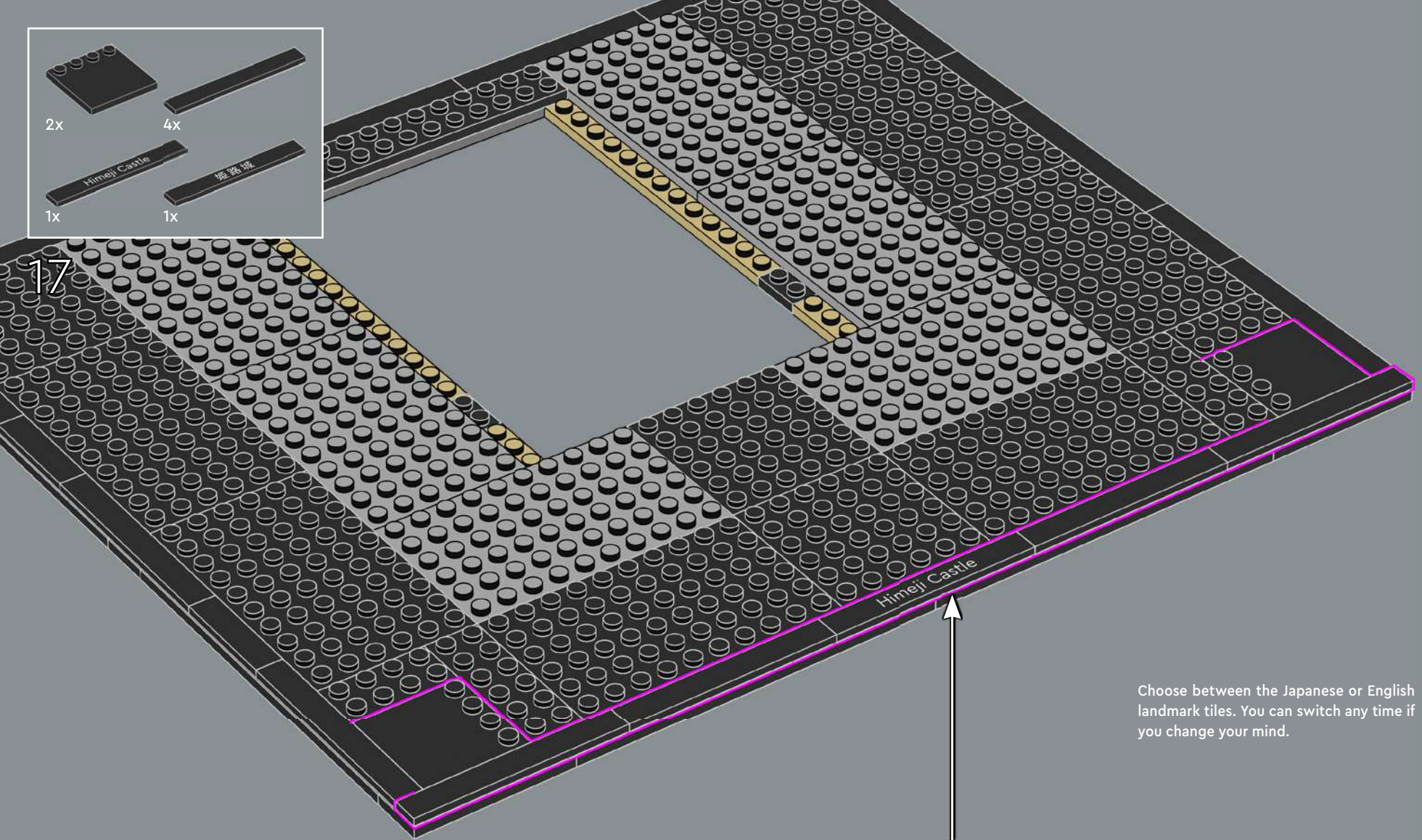

Choose between the Japanese or English landmark tiles. You can switch any time if you change your mind.





In 1993, Himeji Castle was inscribed on UNESCO's World Heritage list, honouring the landmark as a masterpiece and the culmination of Japanese castle architecture in wood.

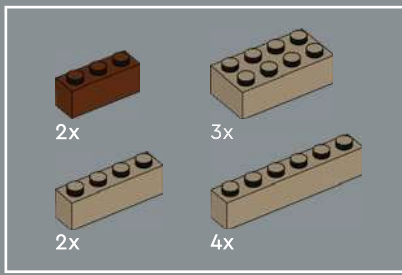

18

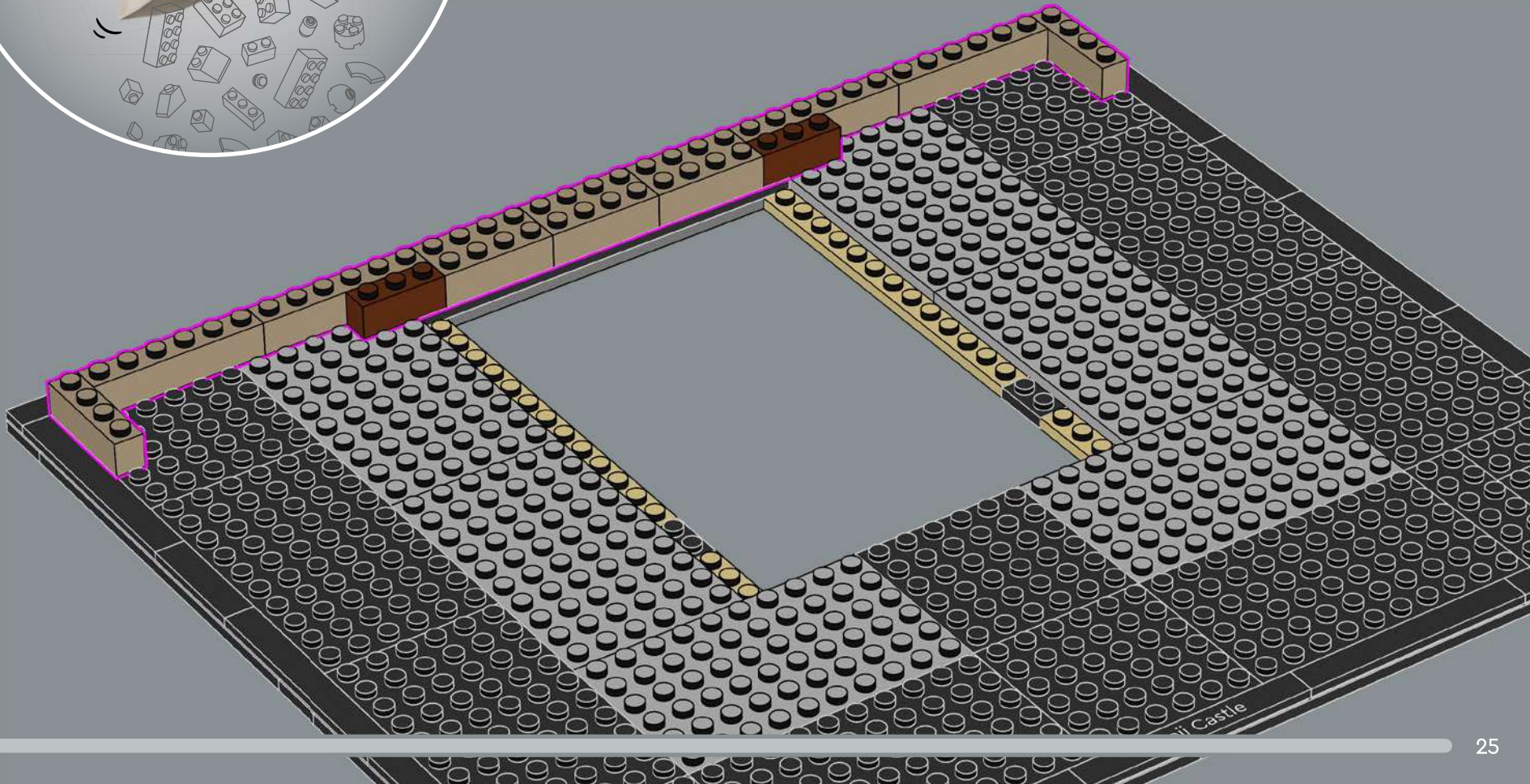



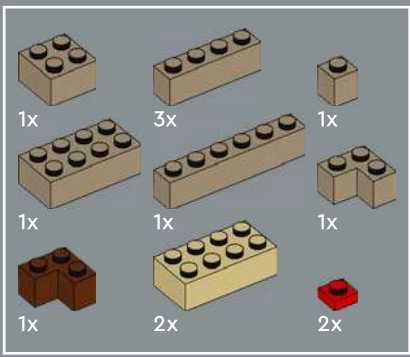

19

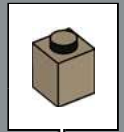
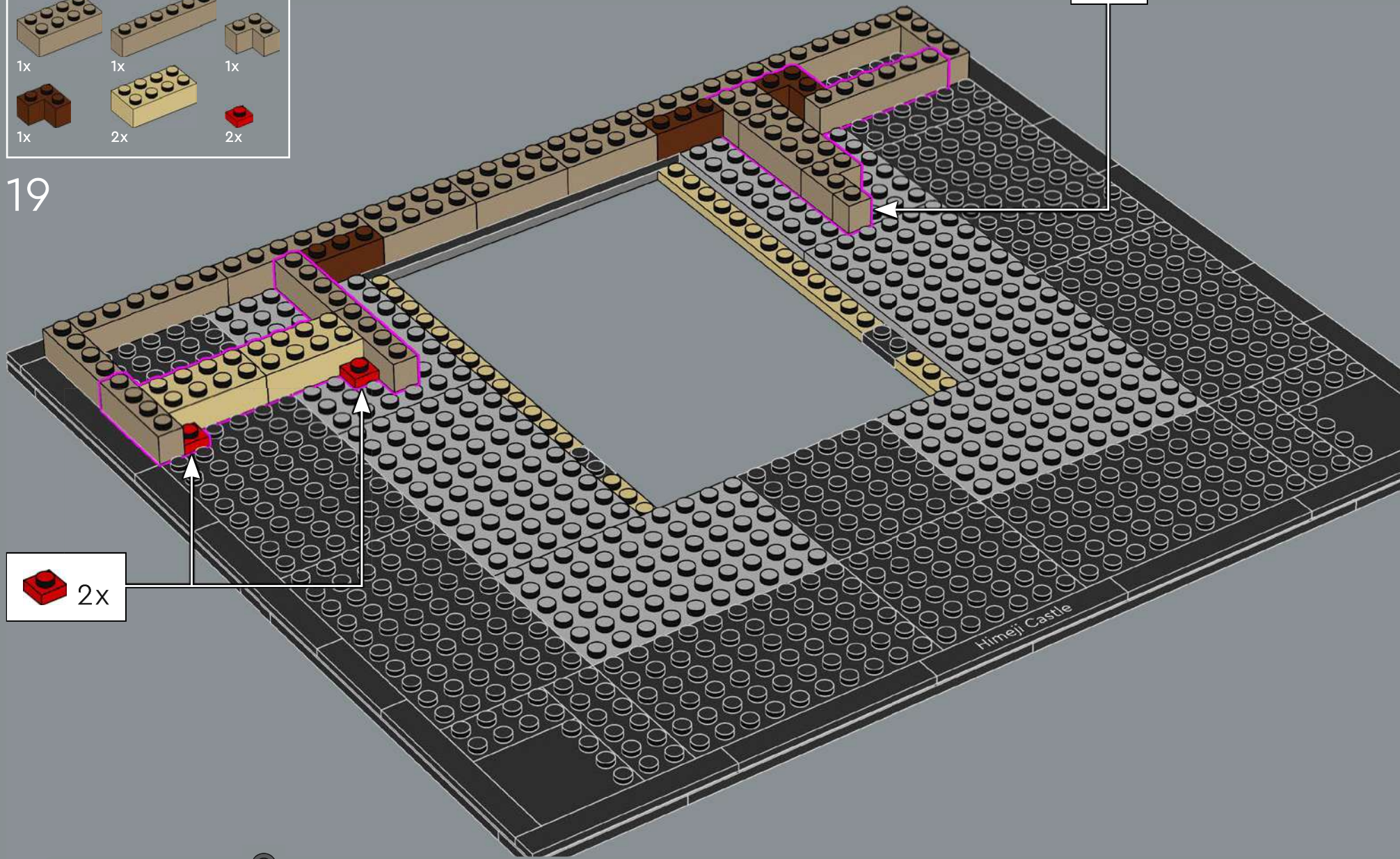

Himeji Castle







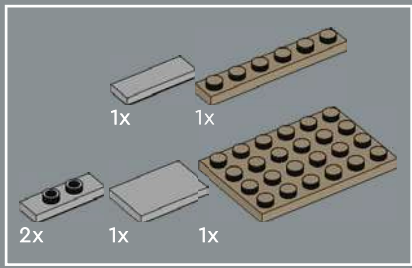

21

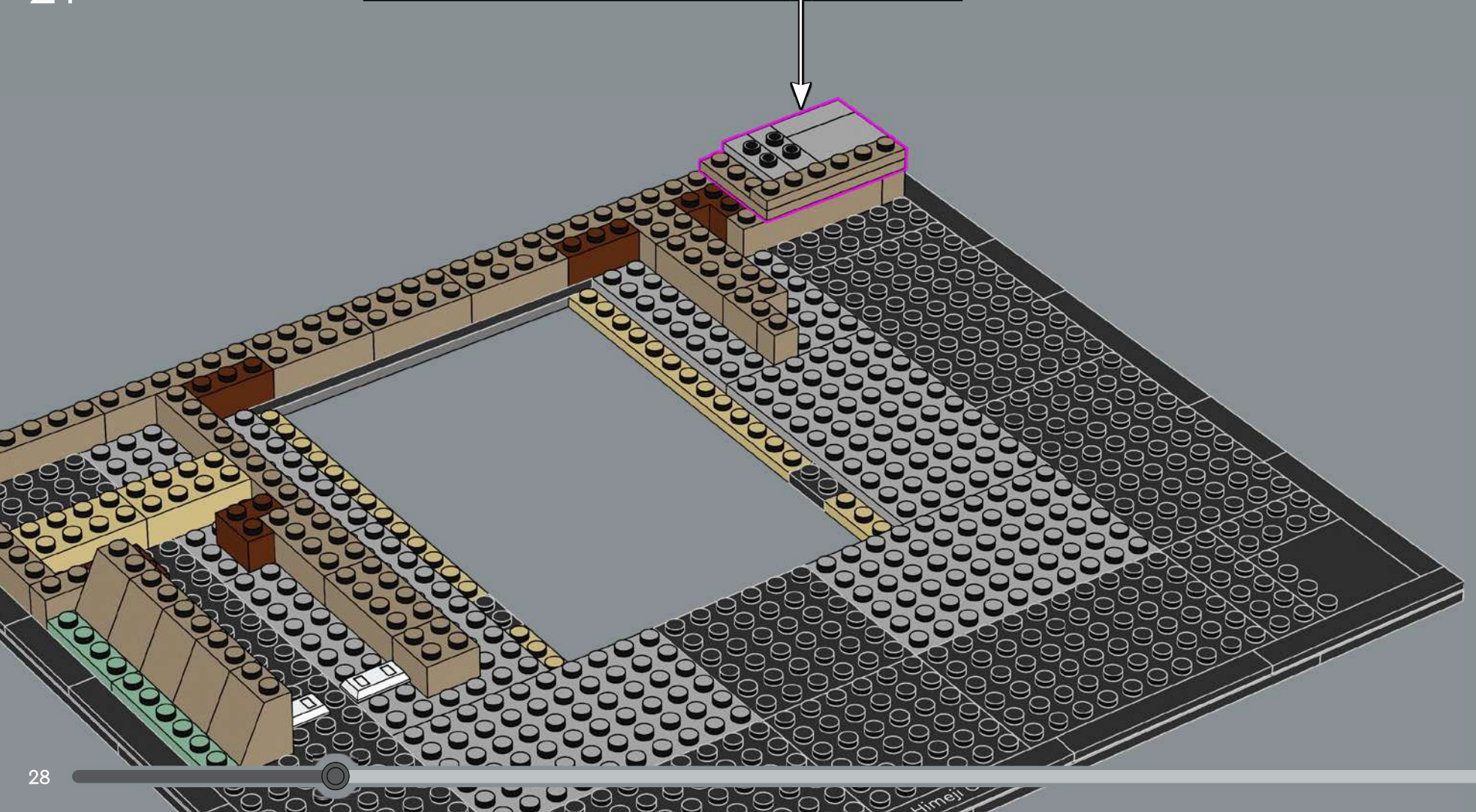
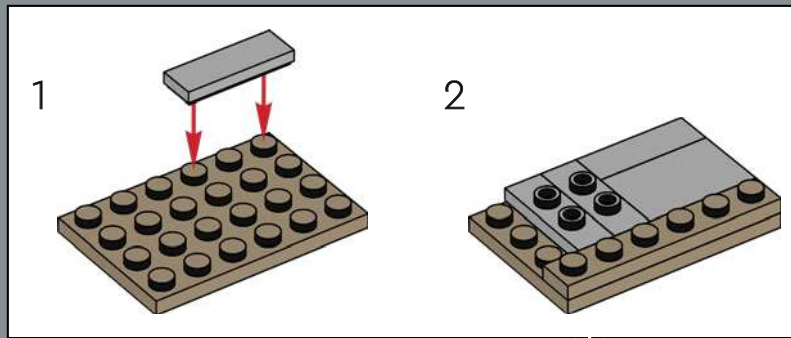

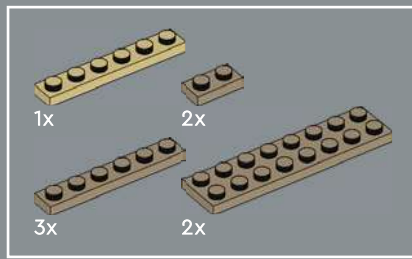



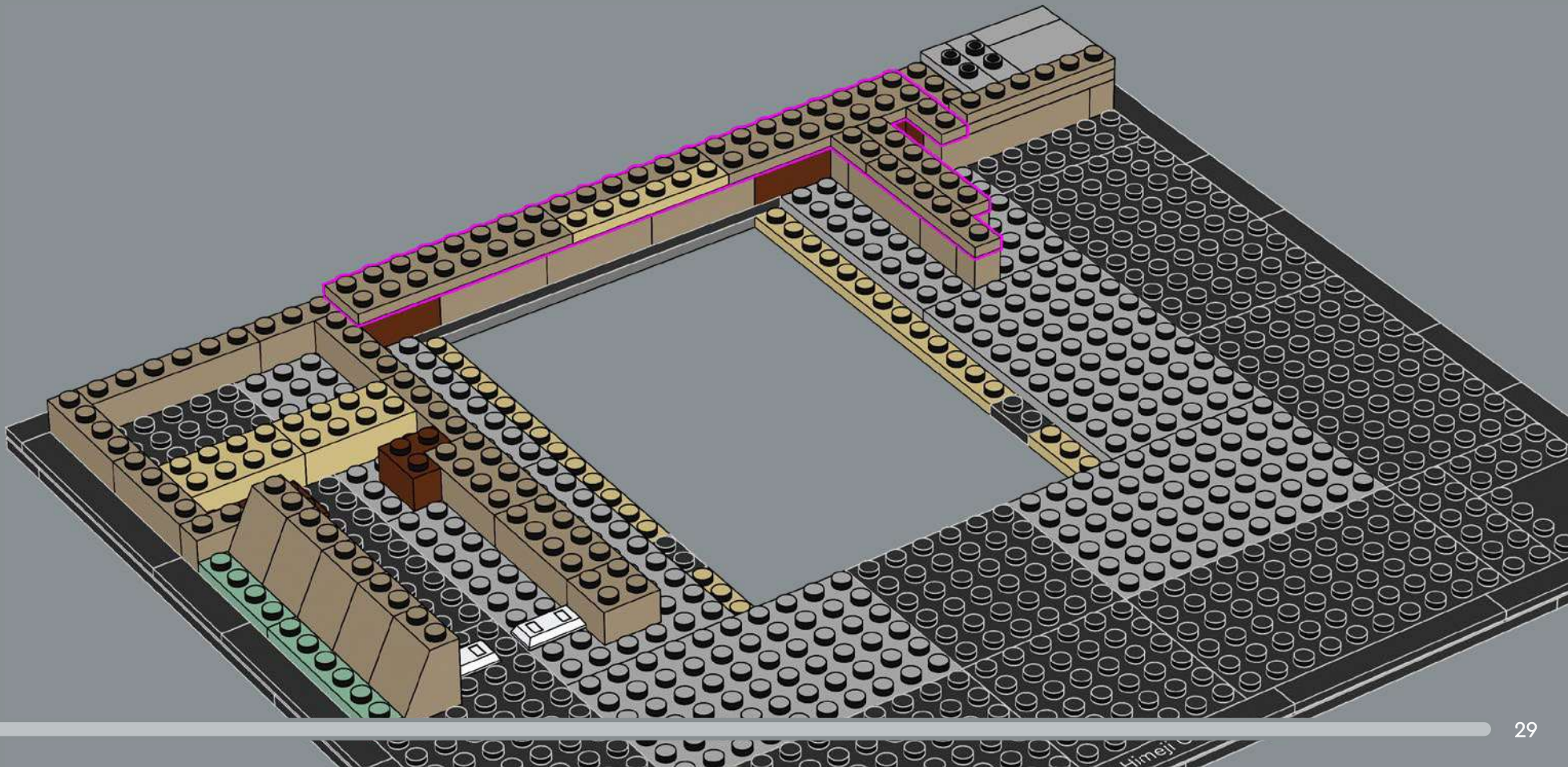

22





- 1x 
- 1x 
- 2x 
- 2x 
- 1x 

23

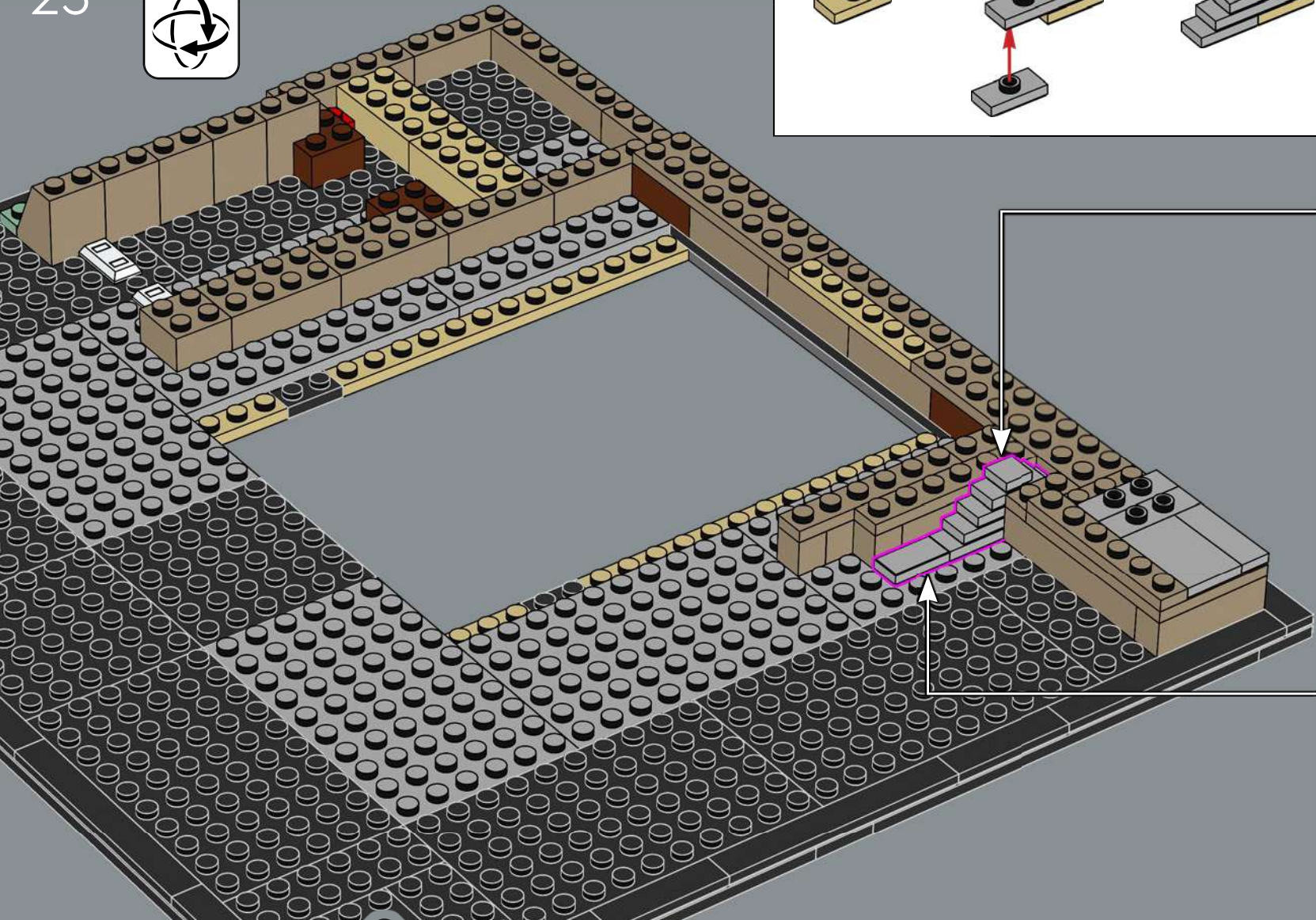
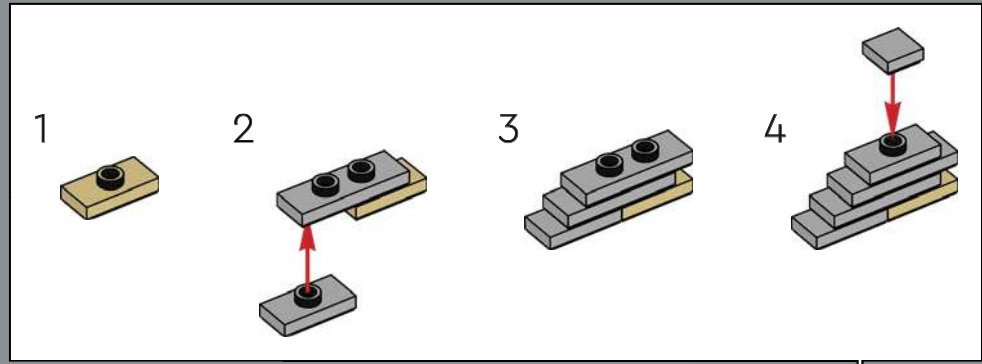



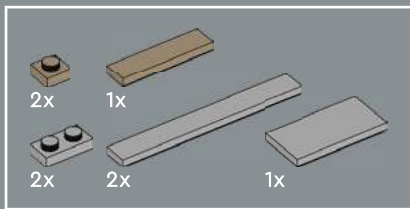

24

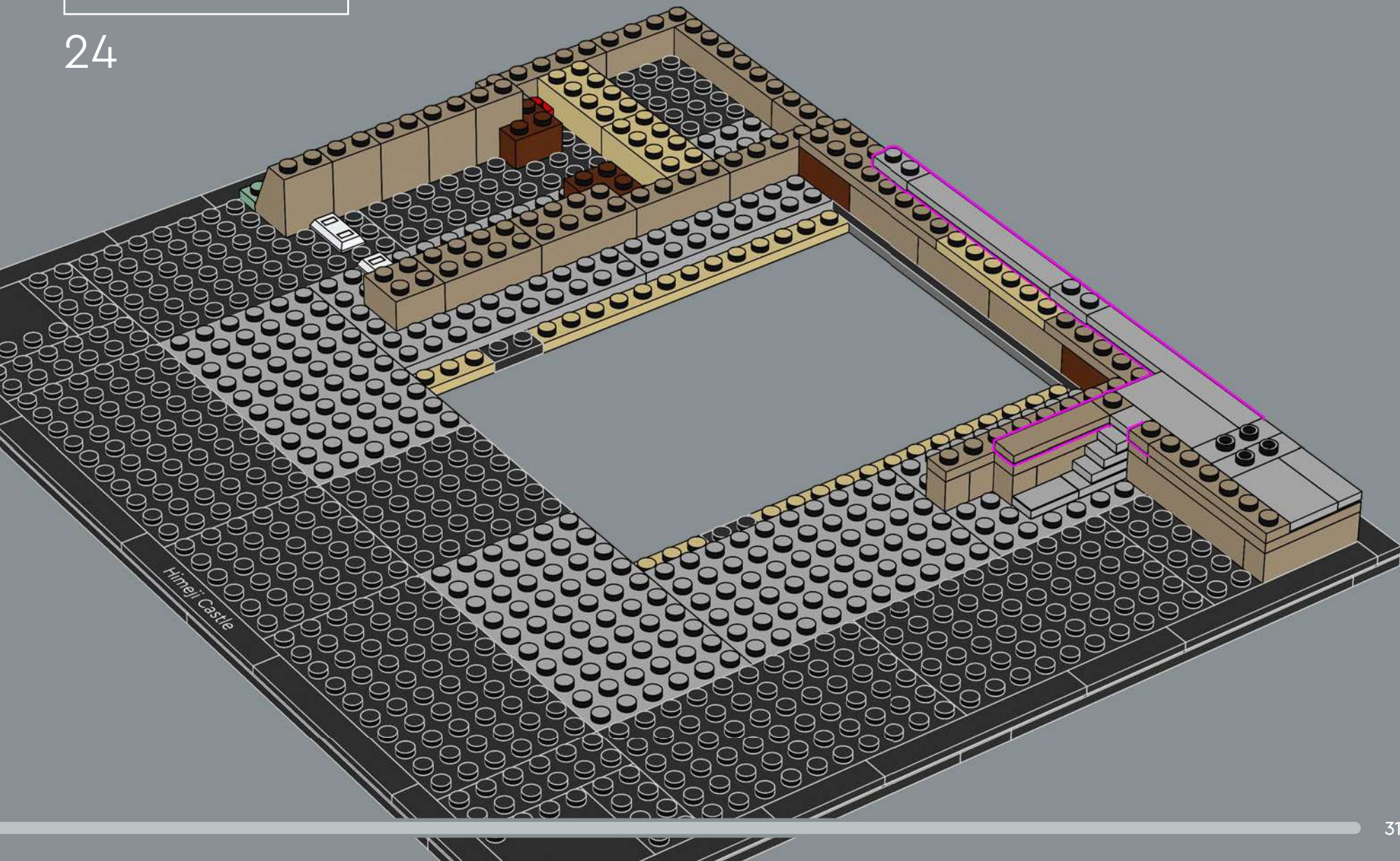



1x 4x 1x

25

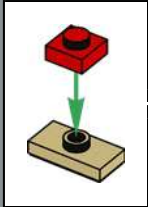
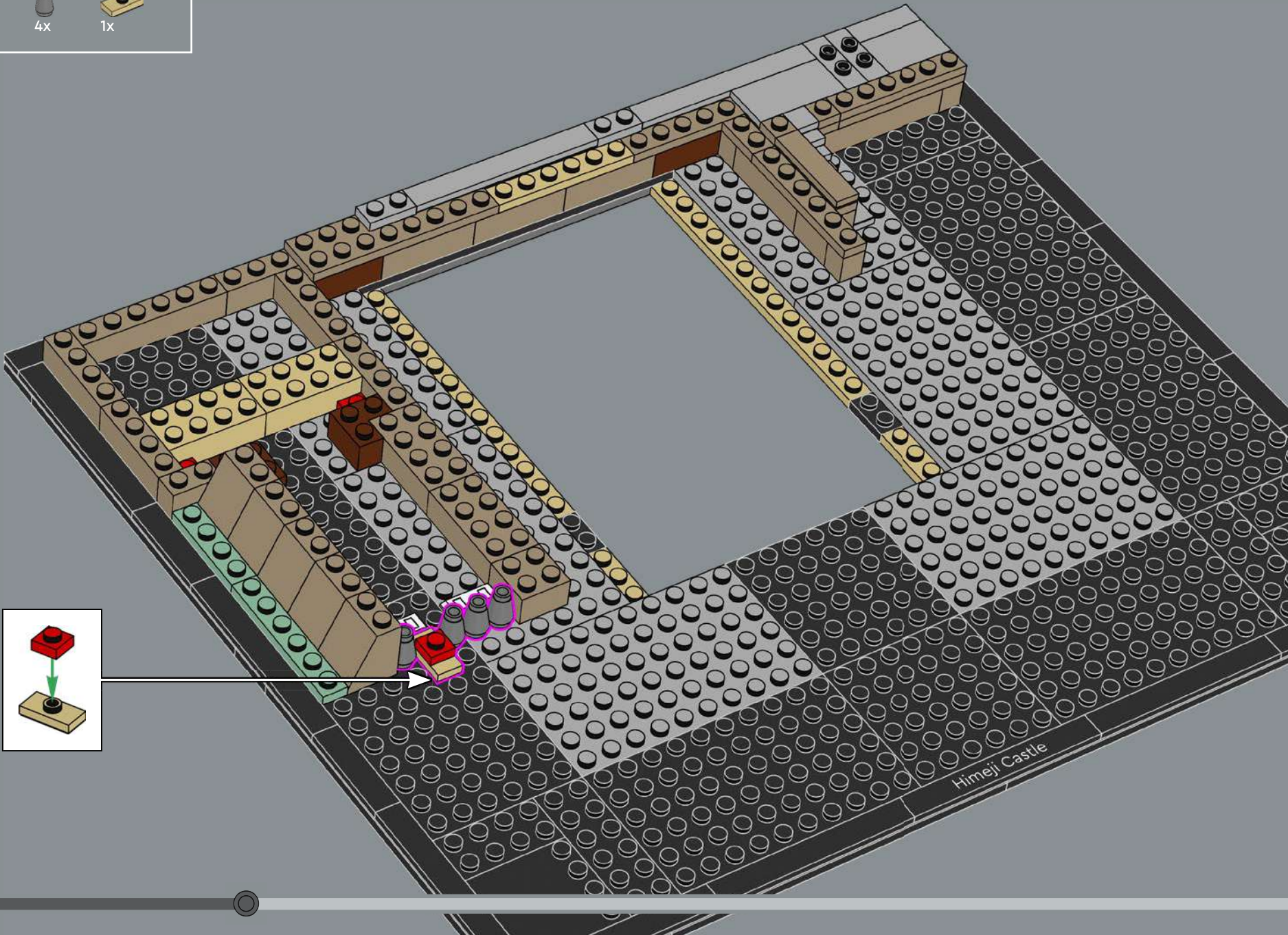

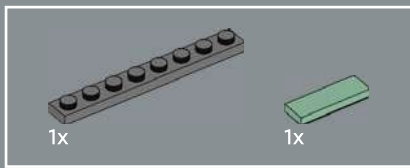

26

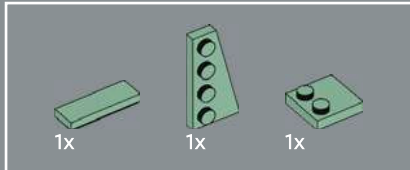
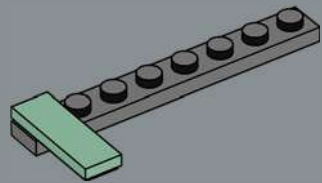

27

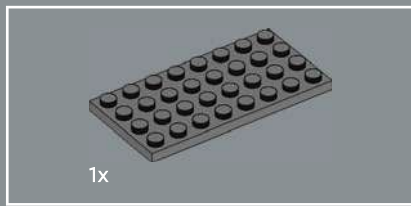
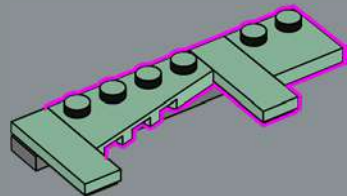

28

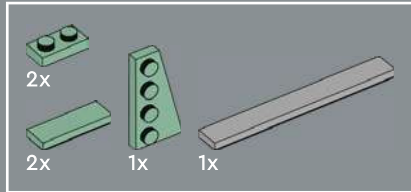
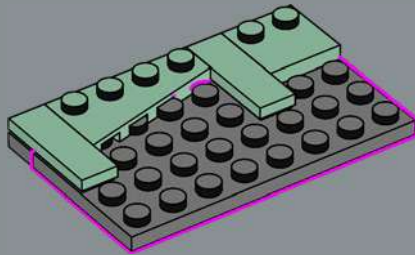

29

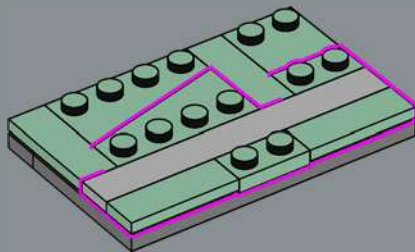

30

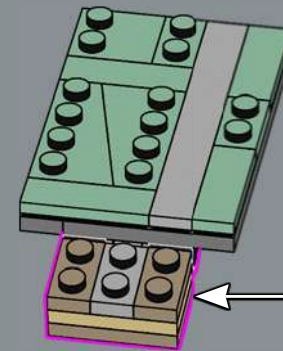
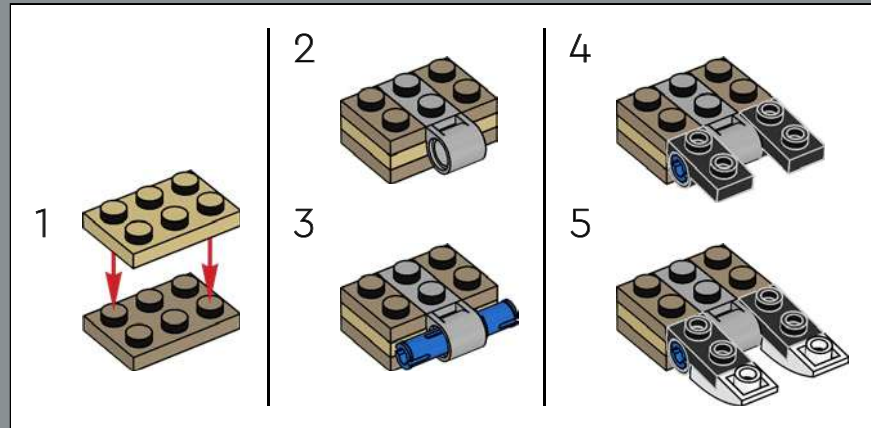



31

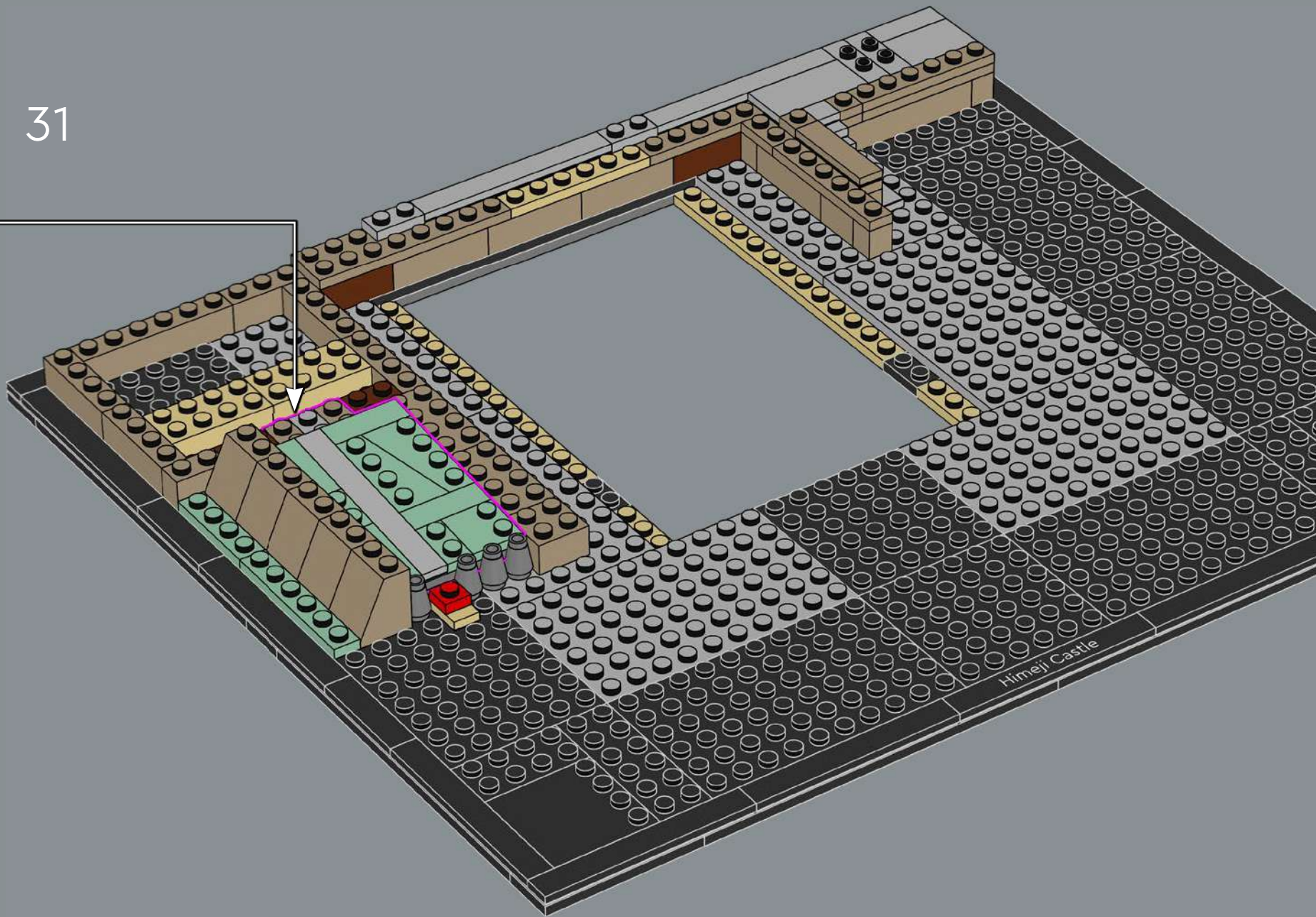



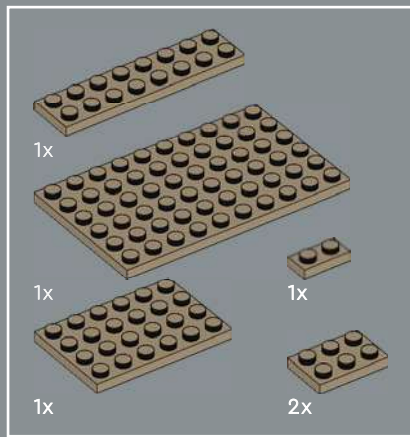

32

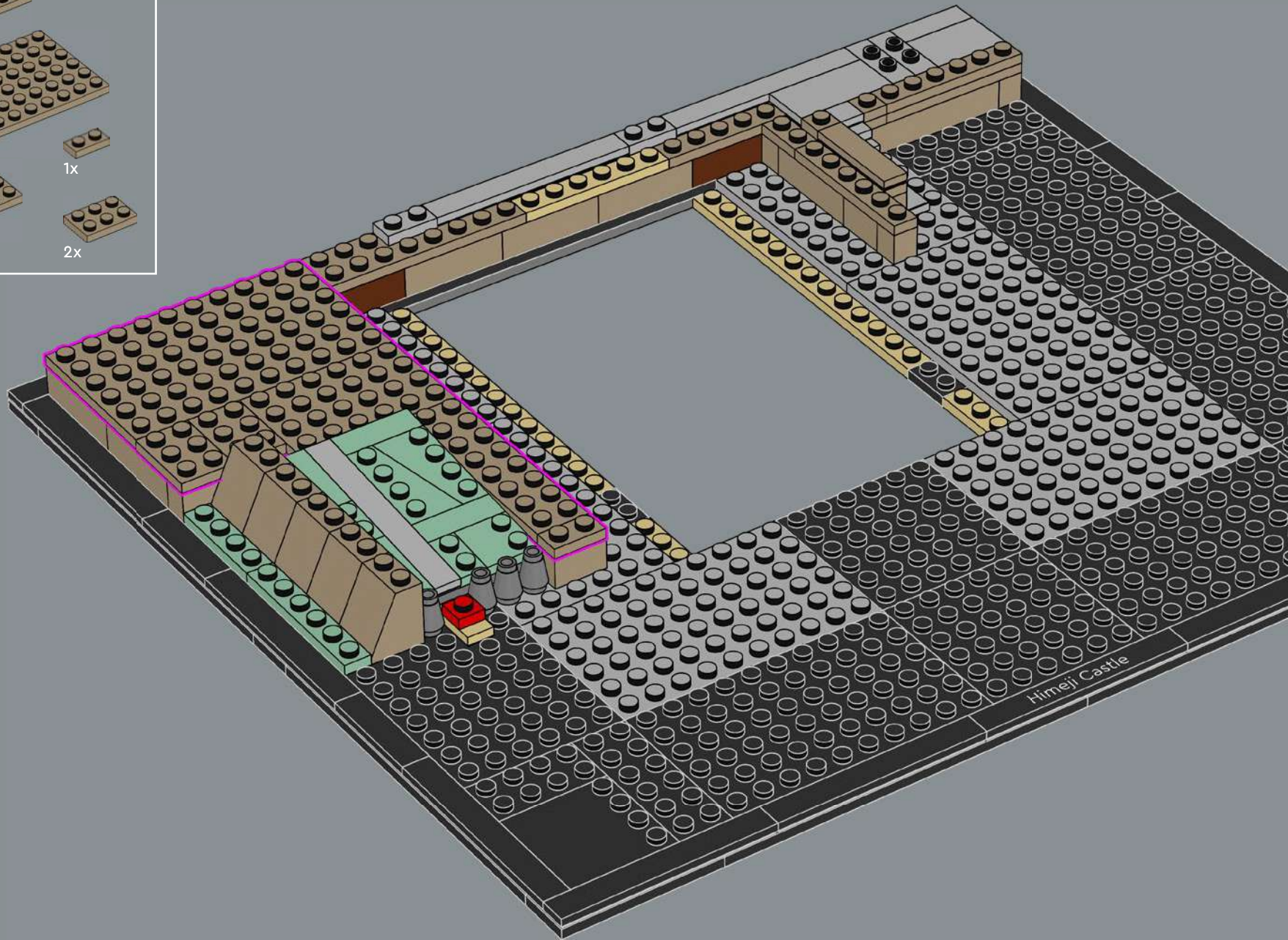



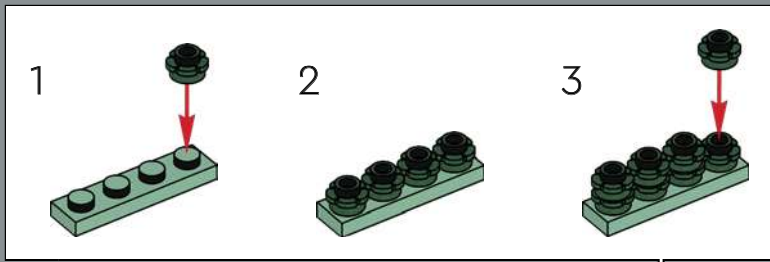
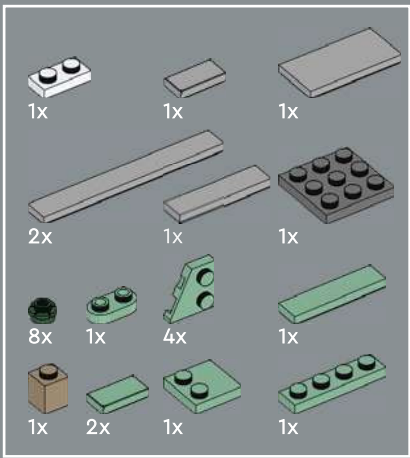

33

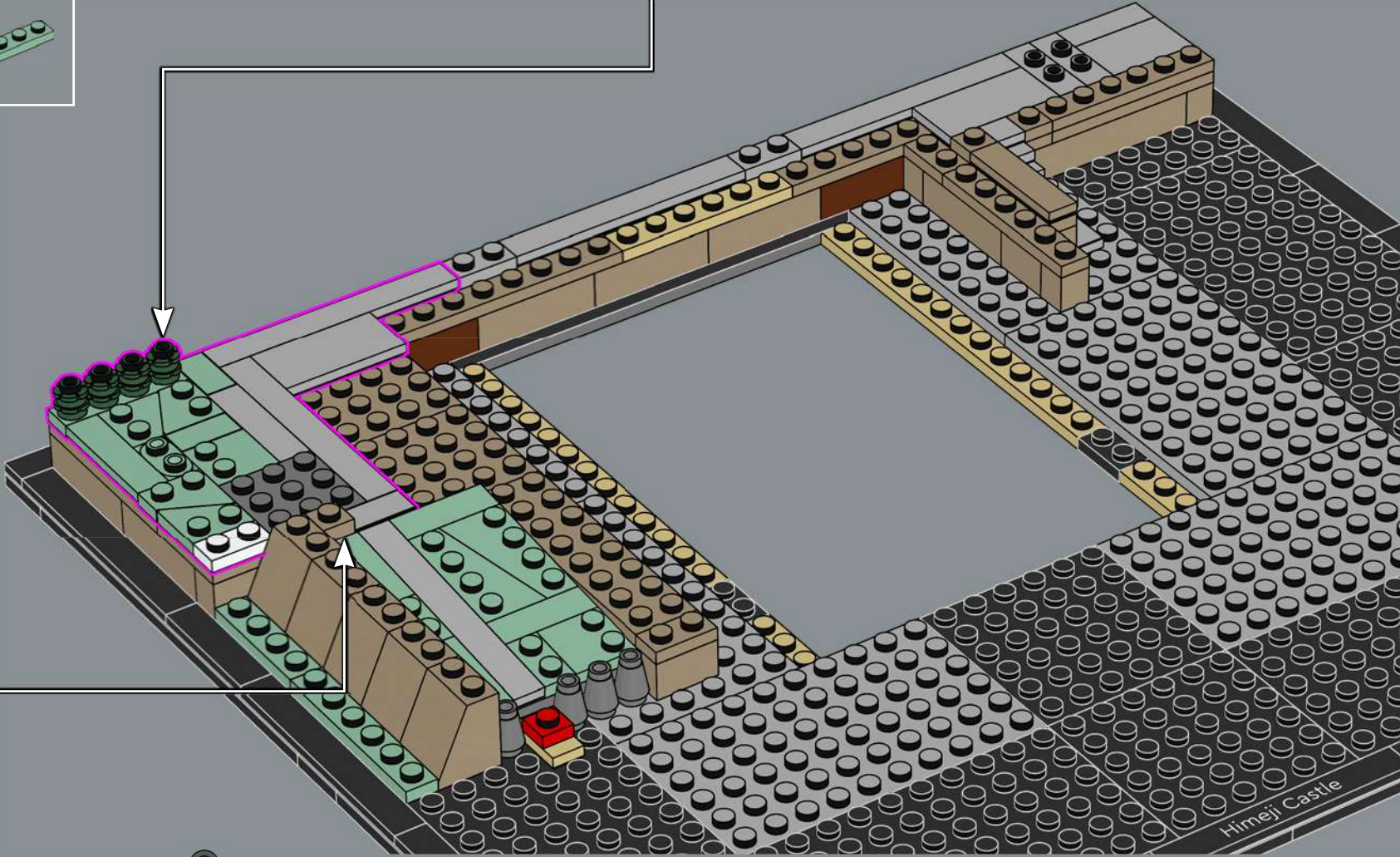

Himeji Castle







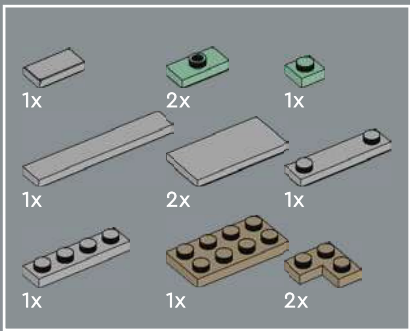

35

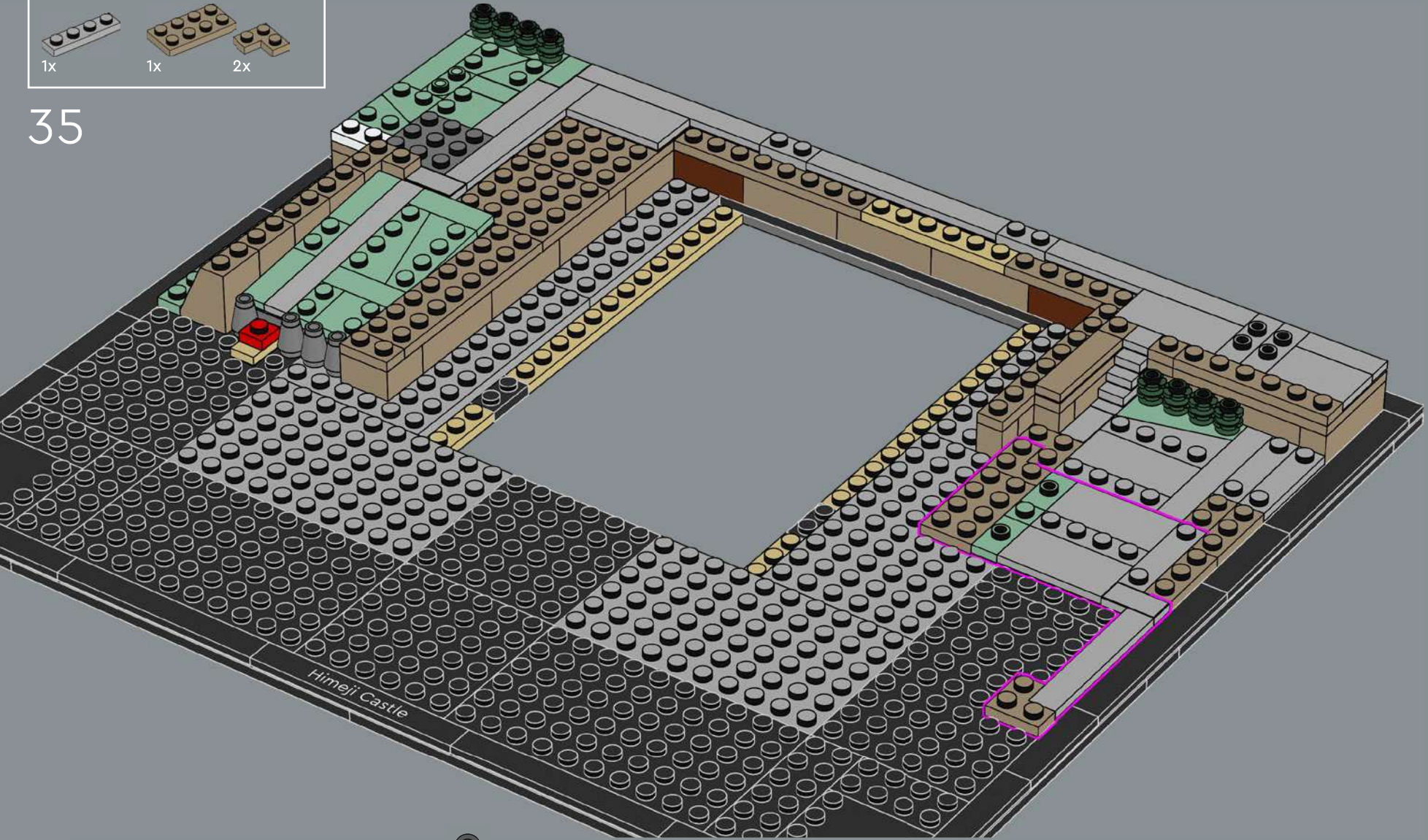



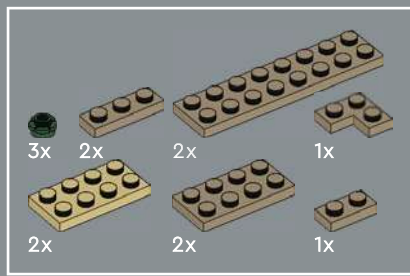

36

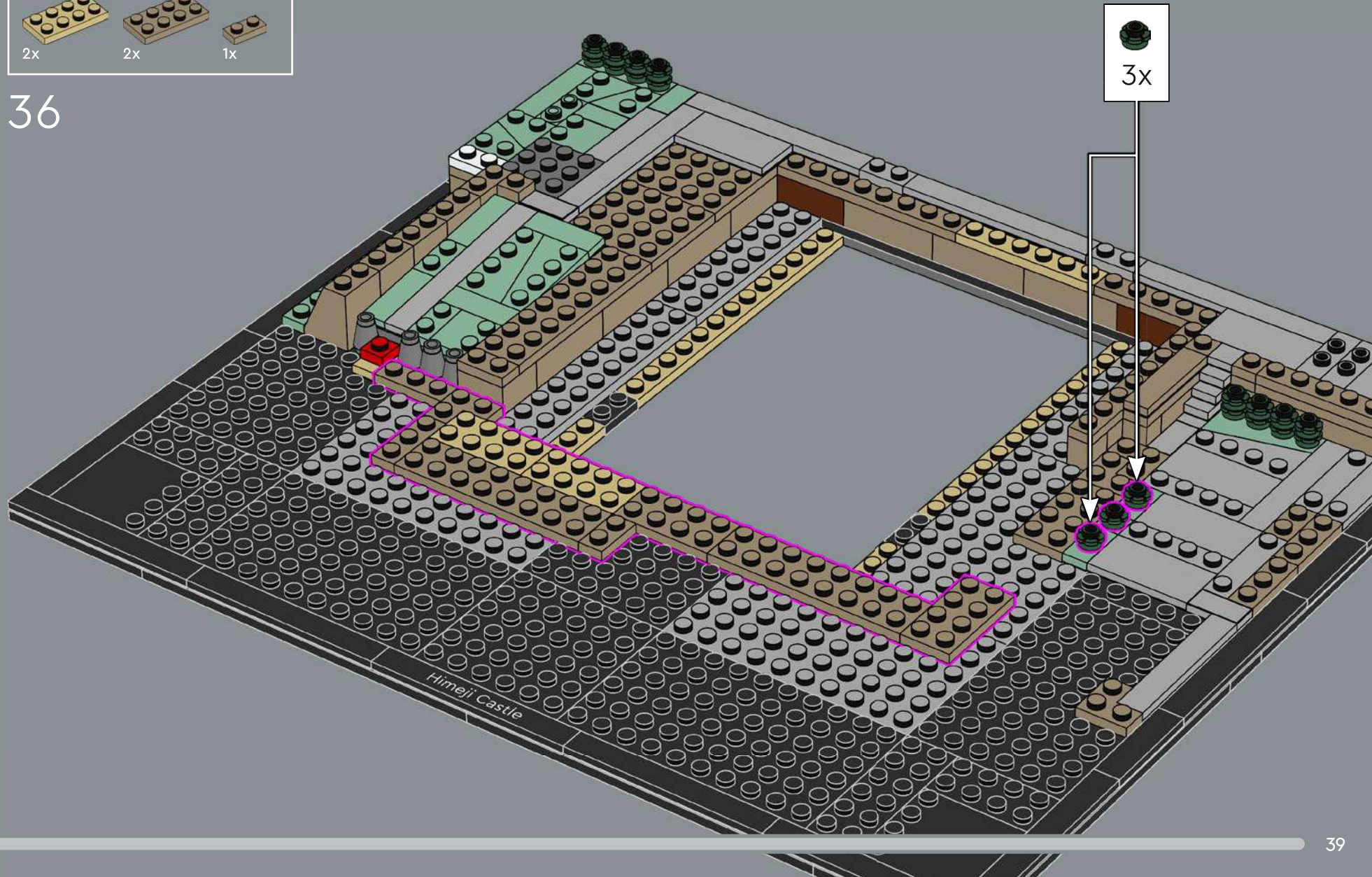



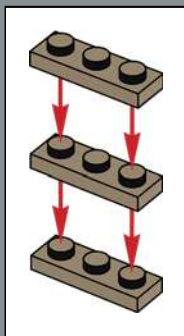
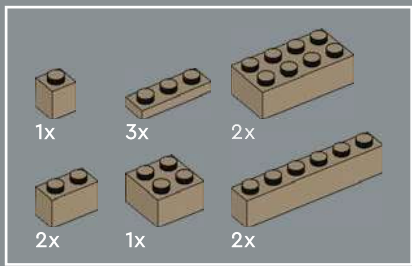

37

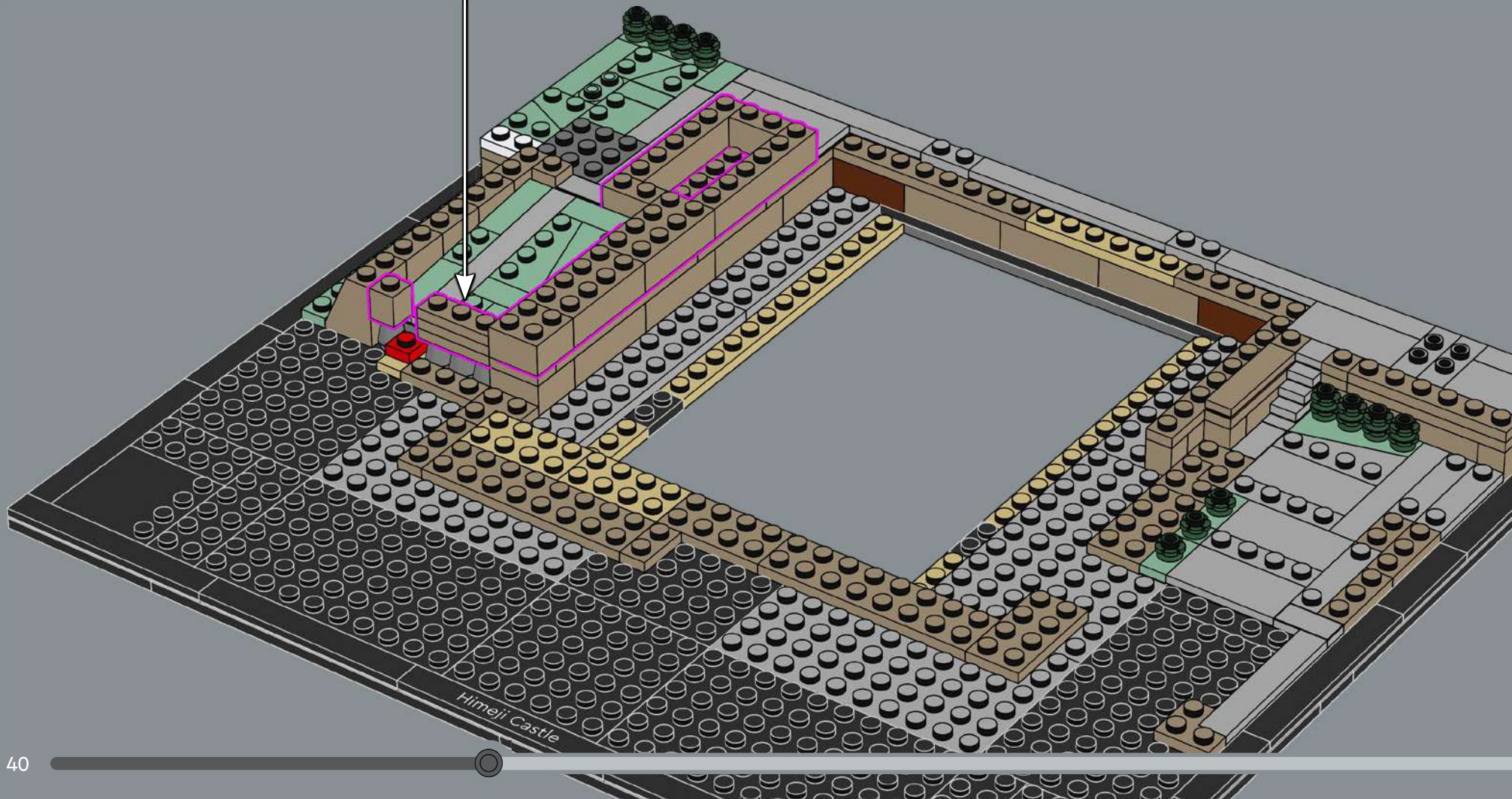



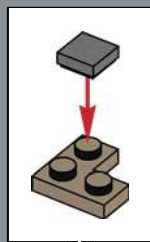
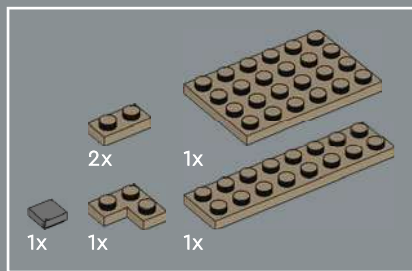

38

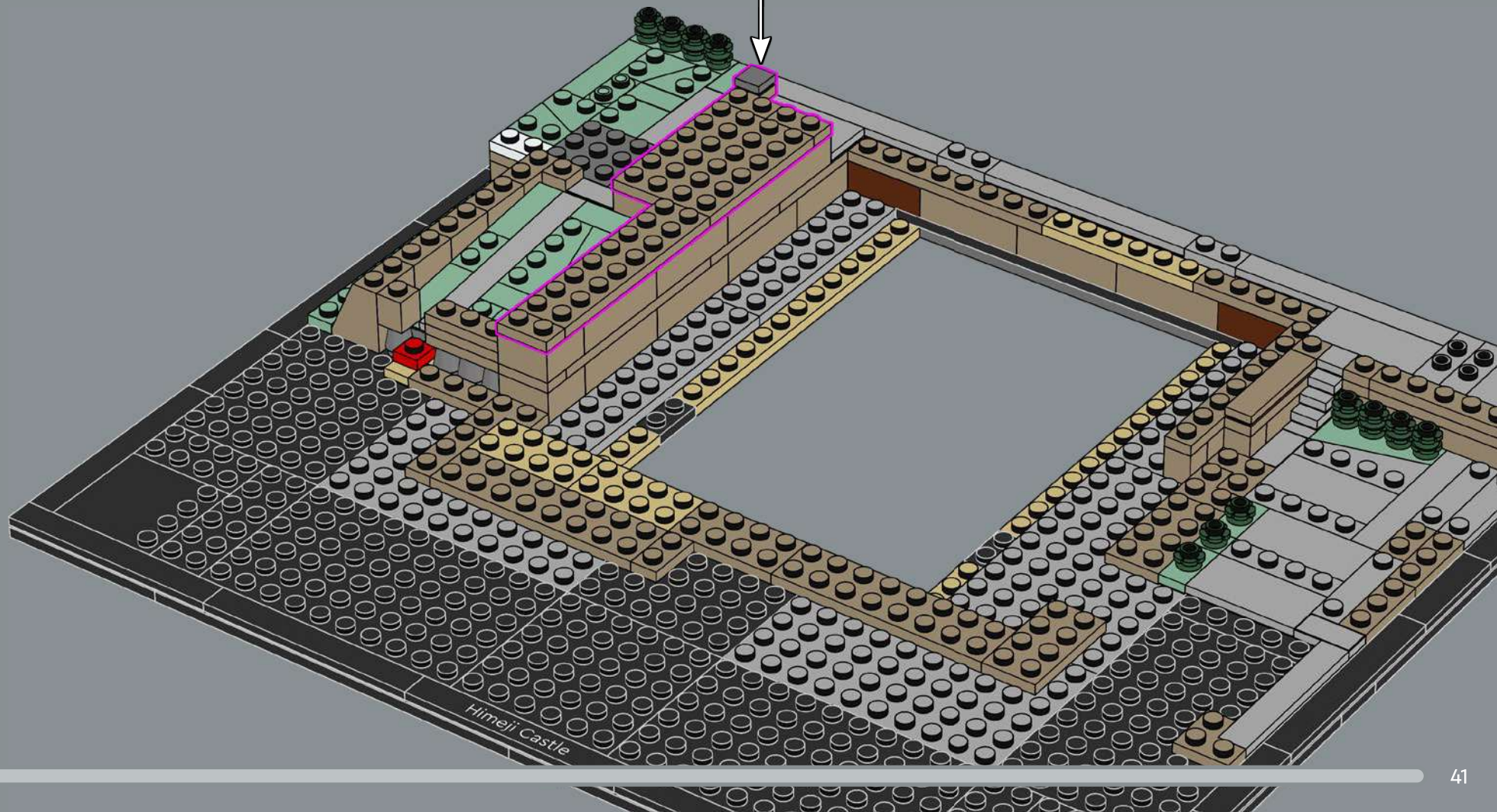



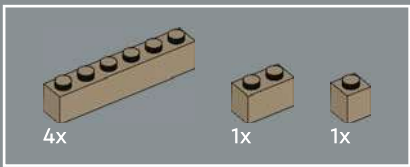

39

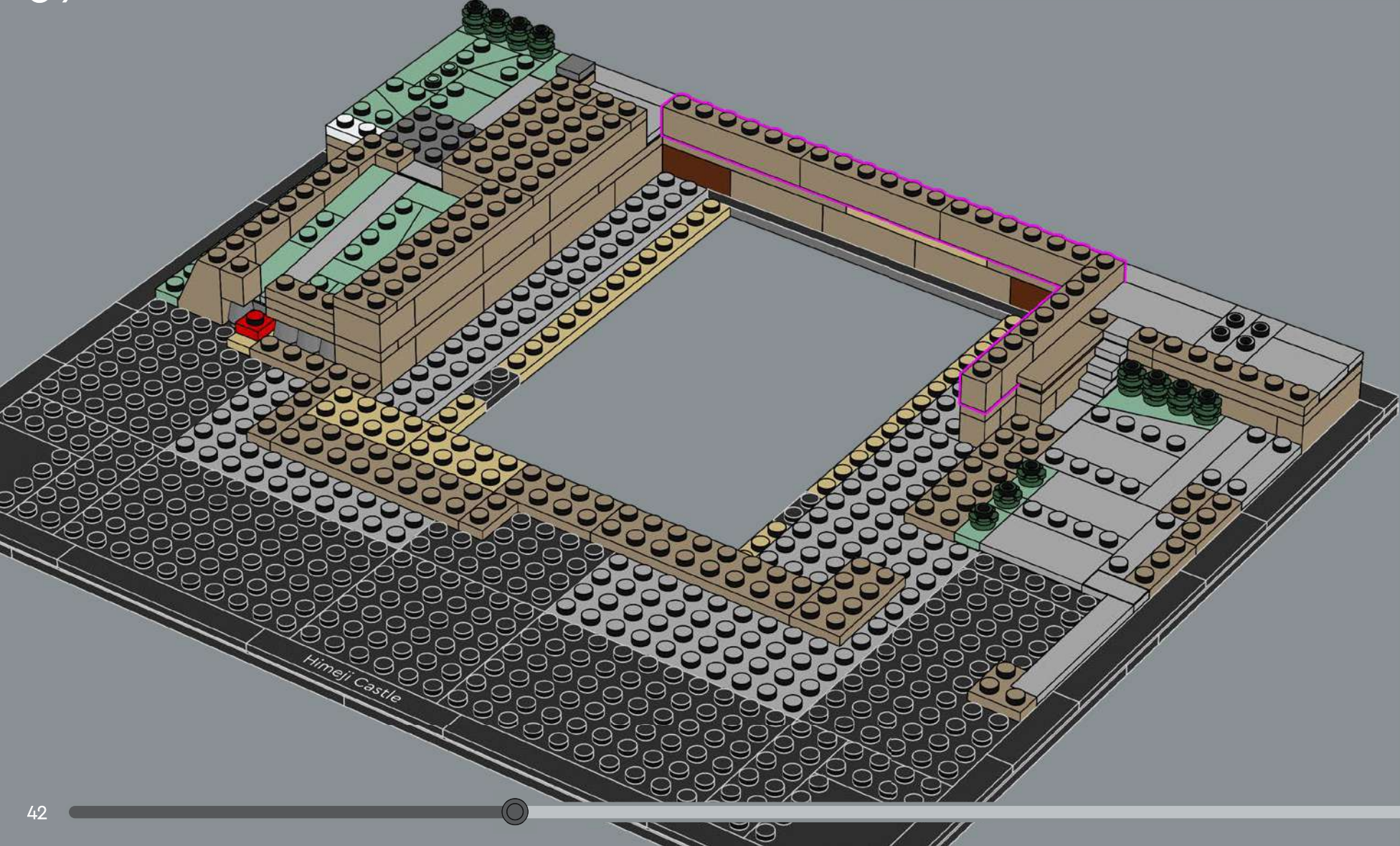



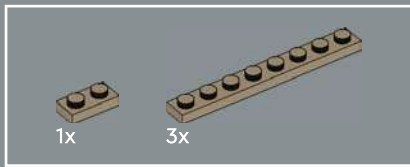

40

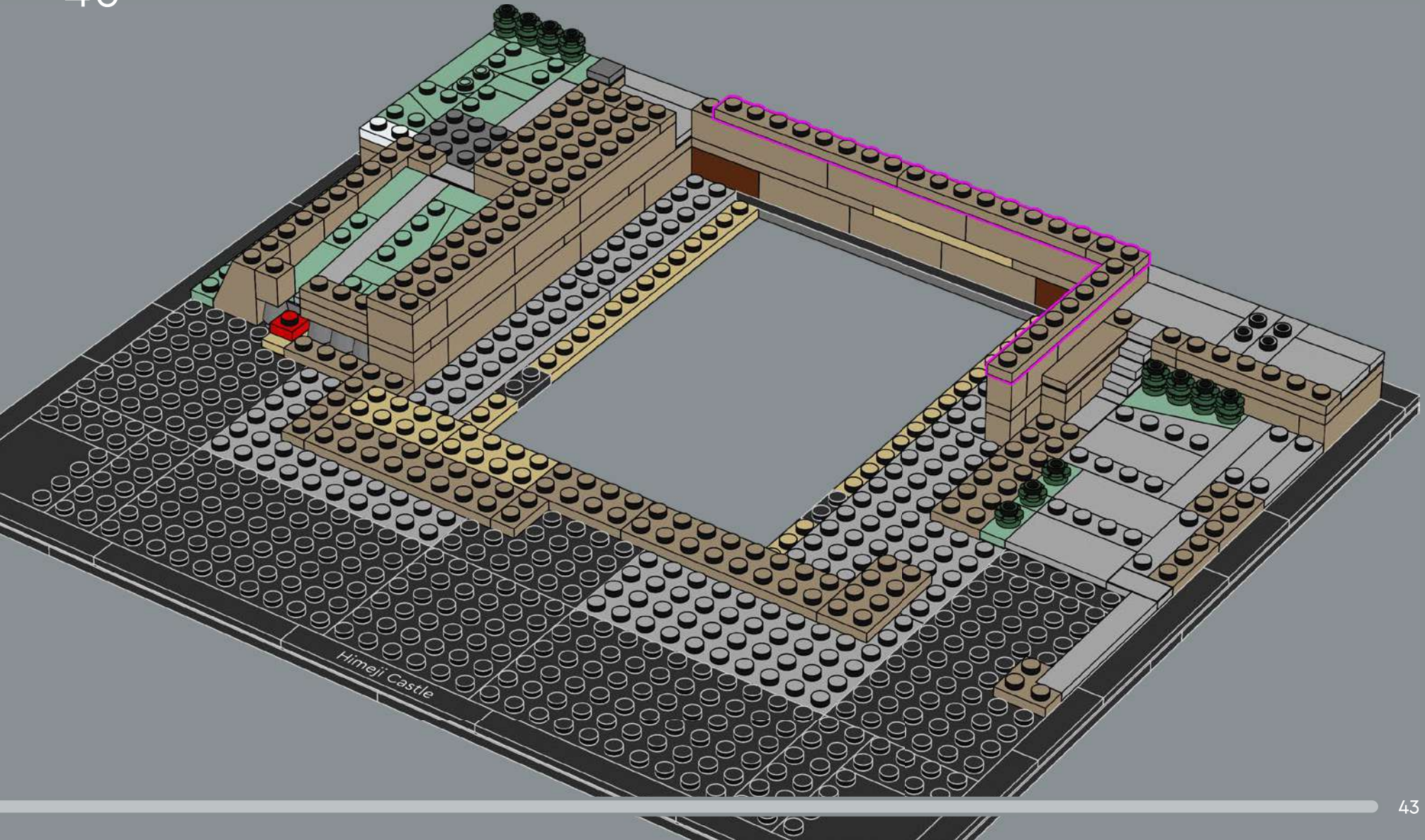



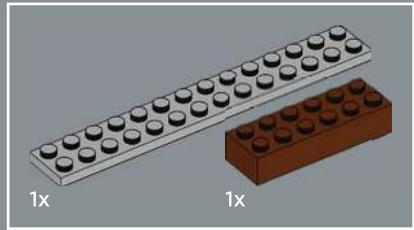
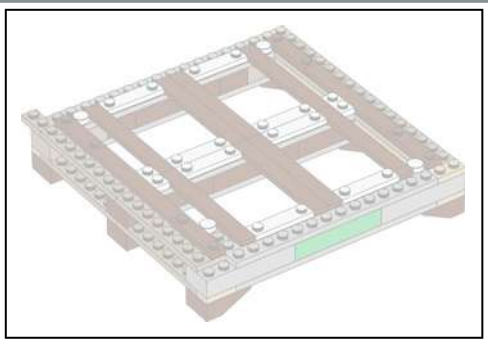

41

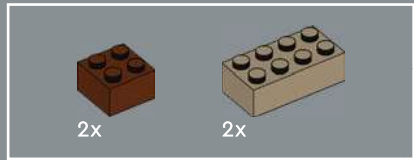
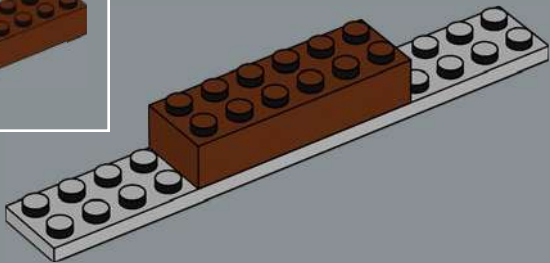

42

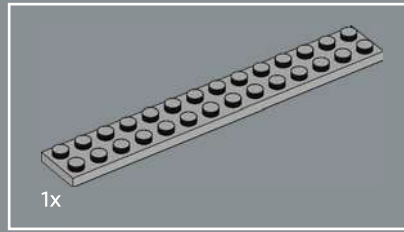
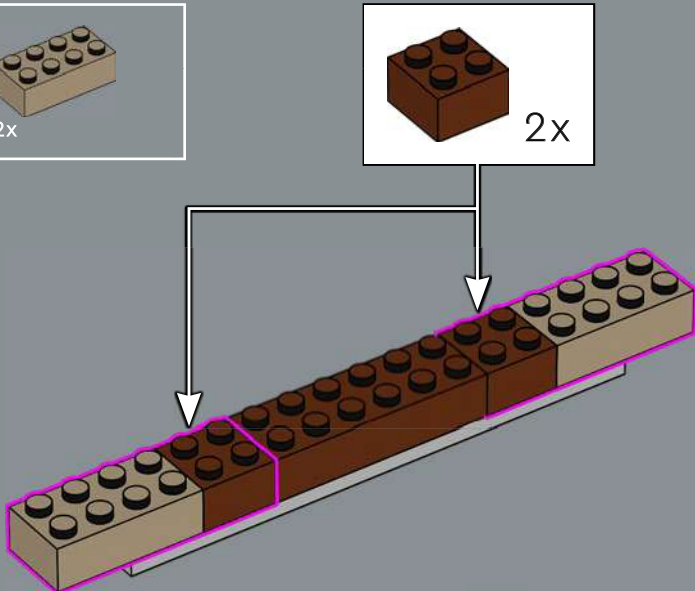

43

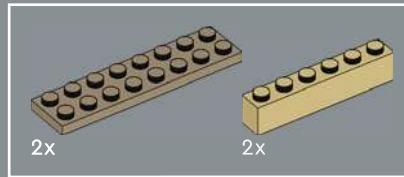
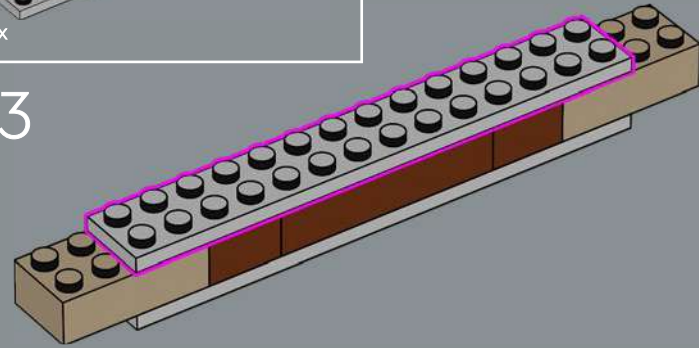

44

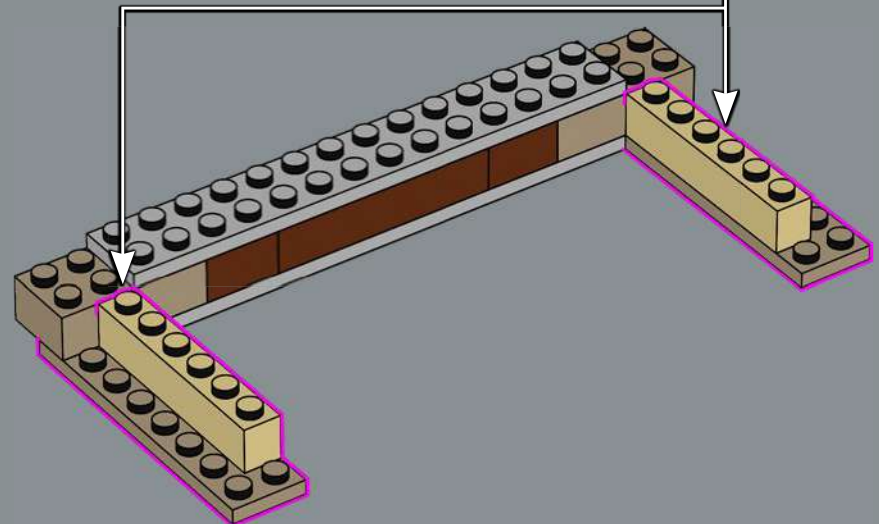
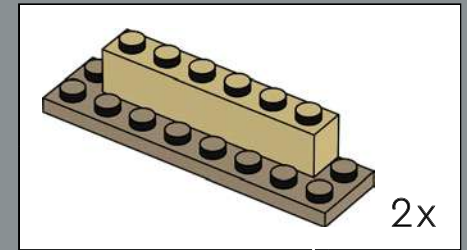

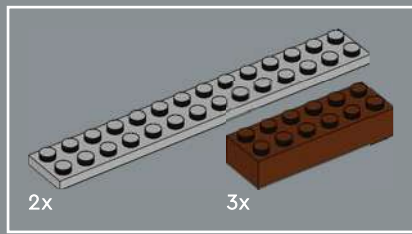

45

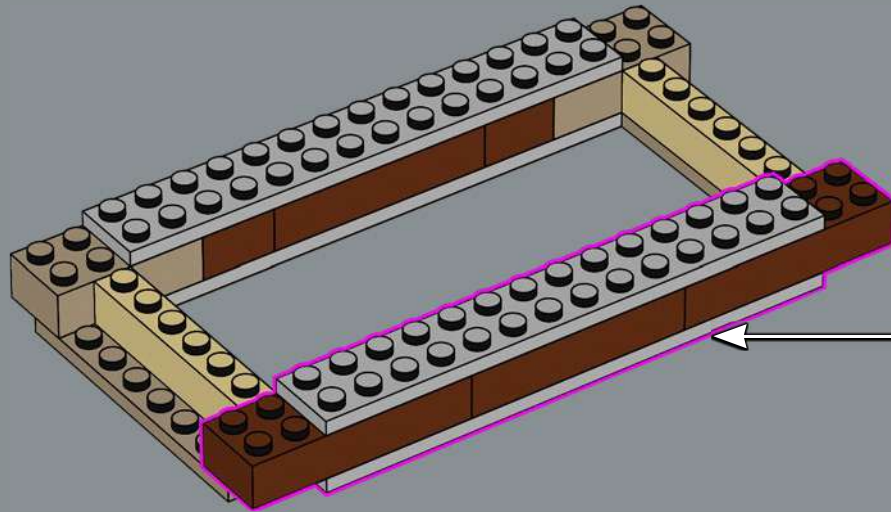

1

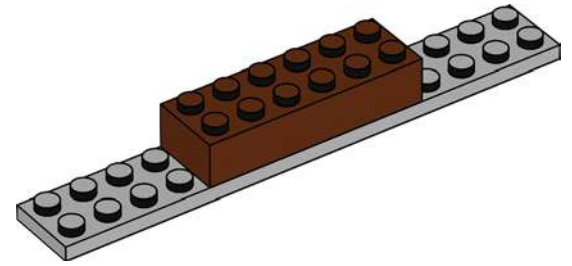

2

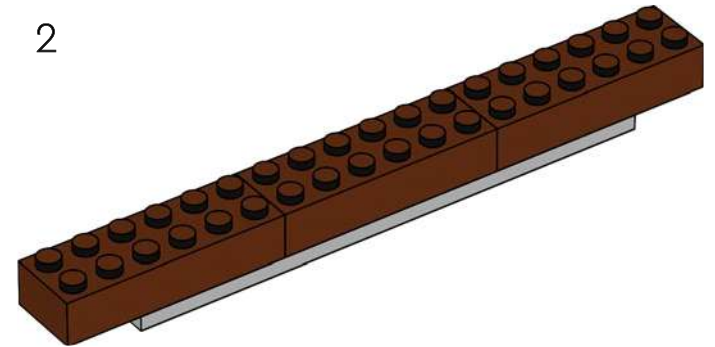

3

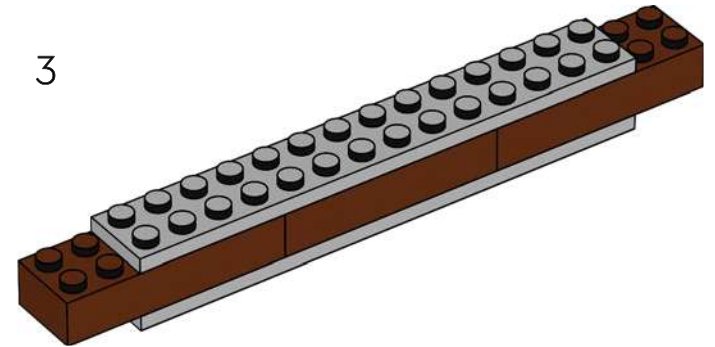



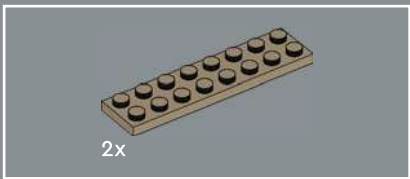

46

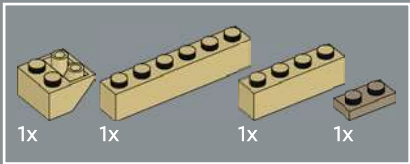
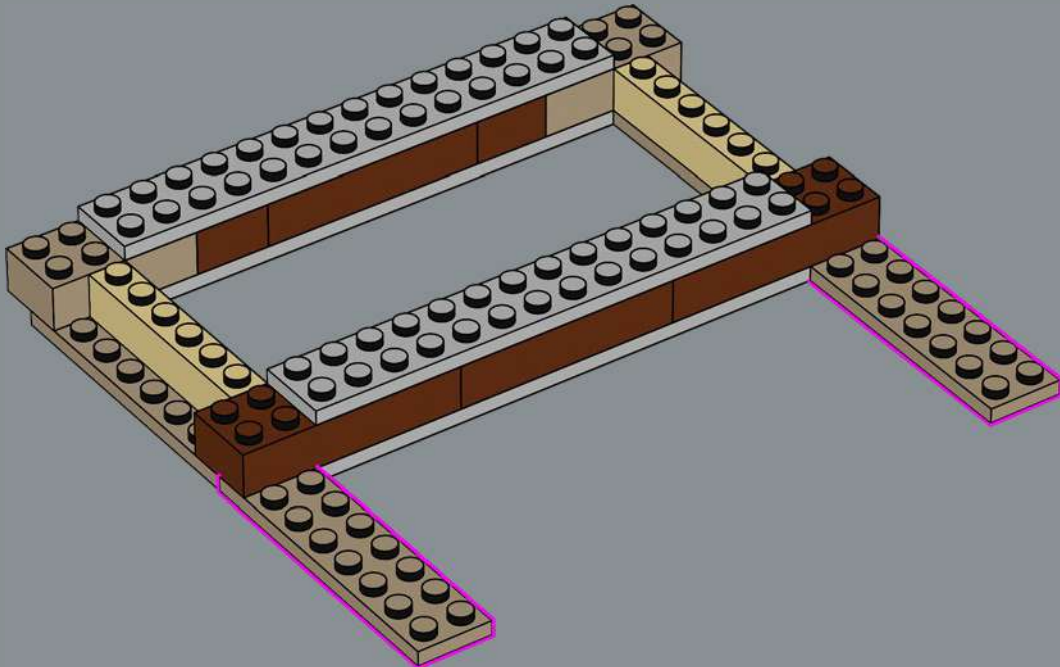

47

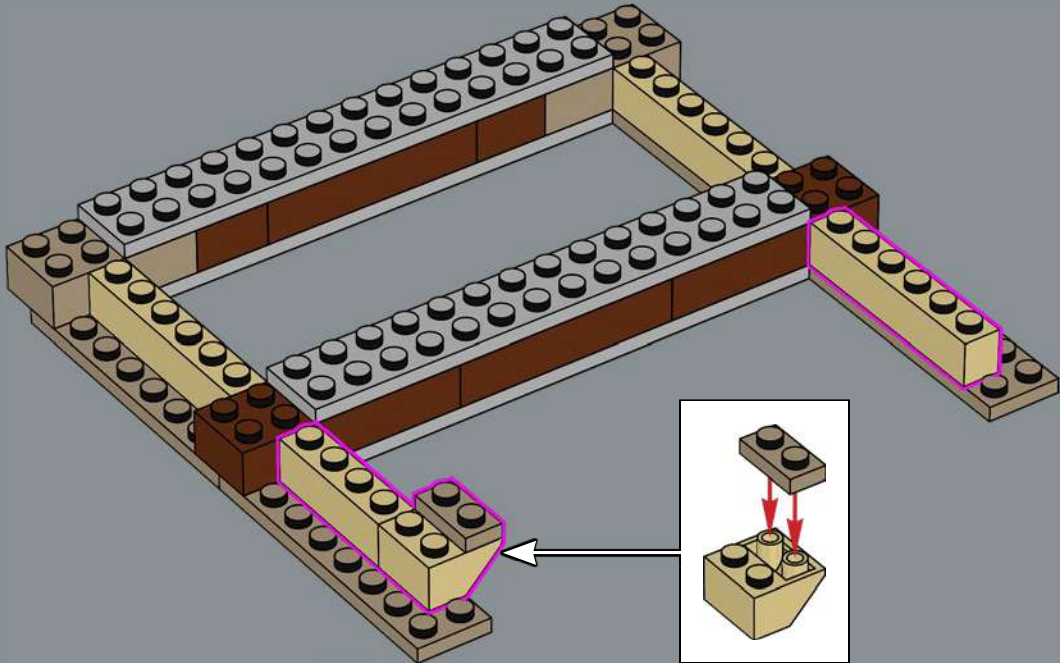

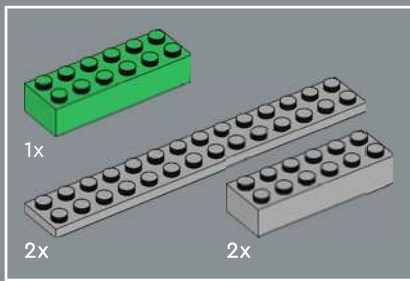

48

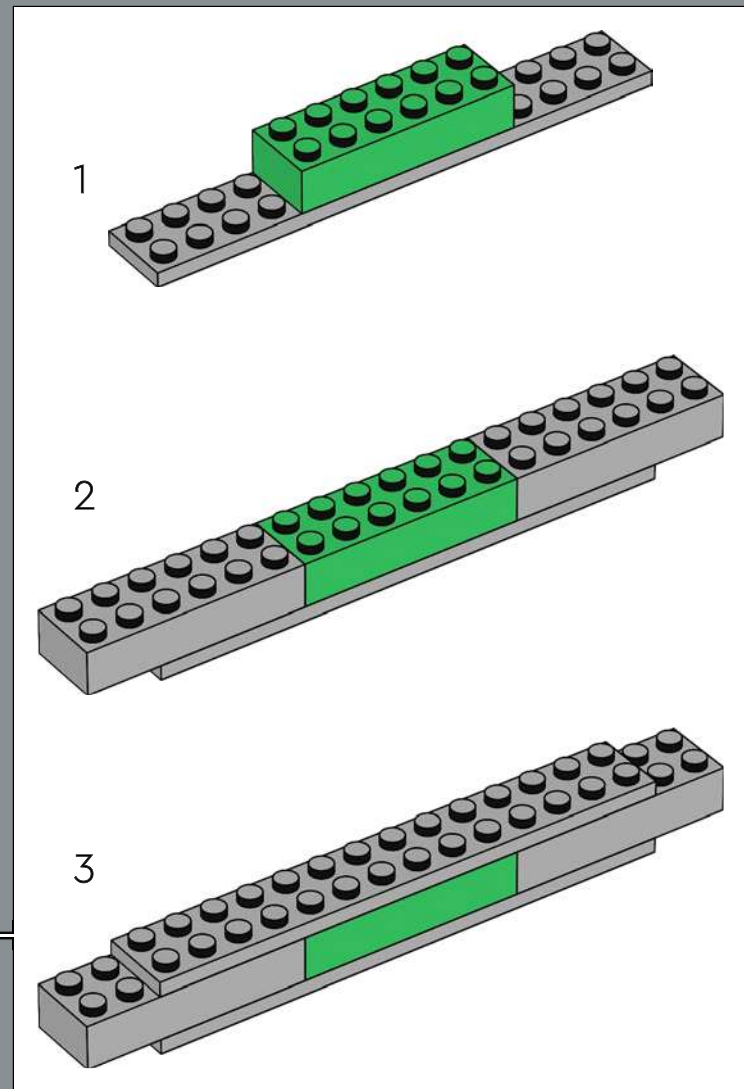
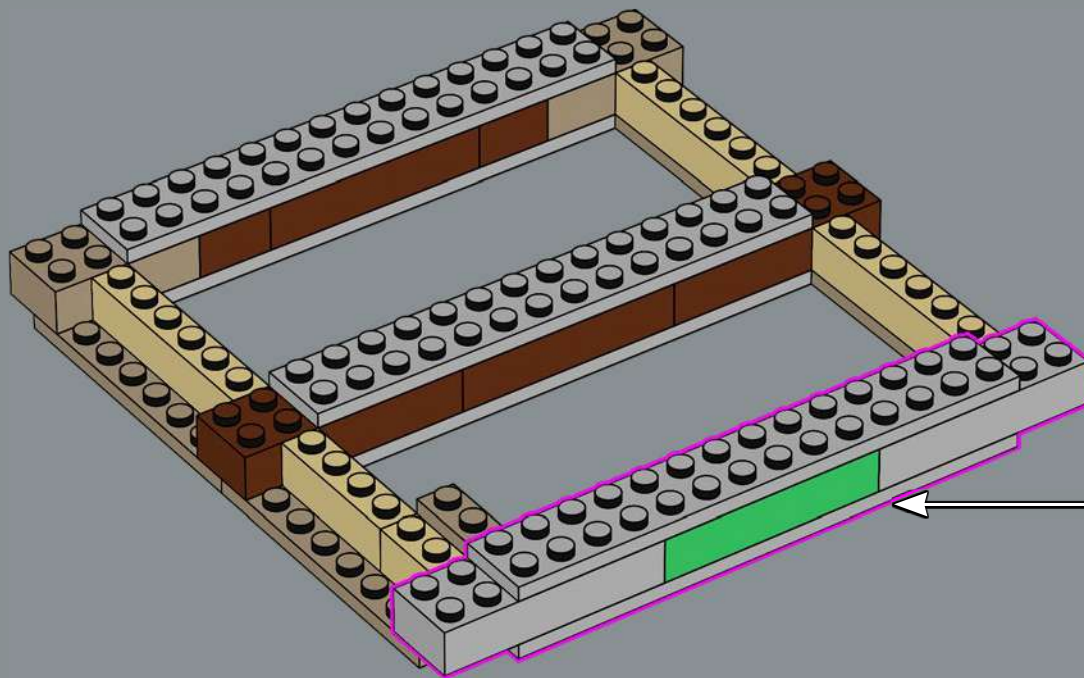



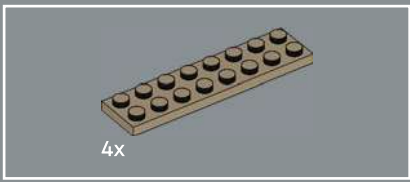

49

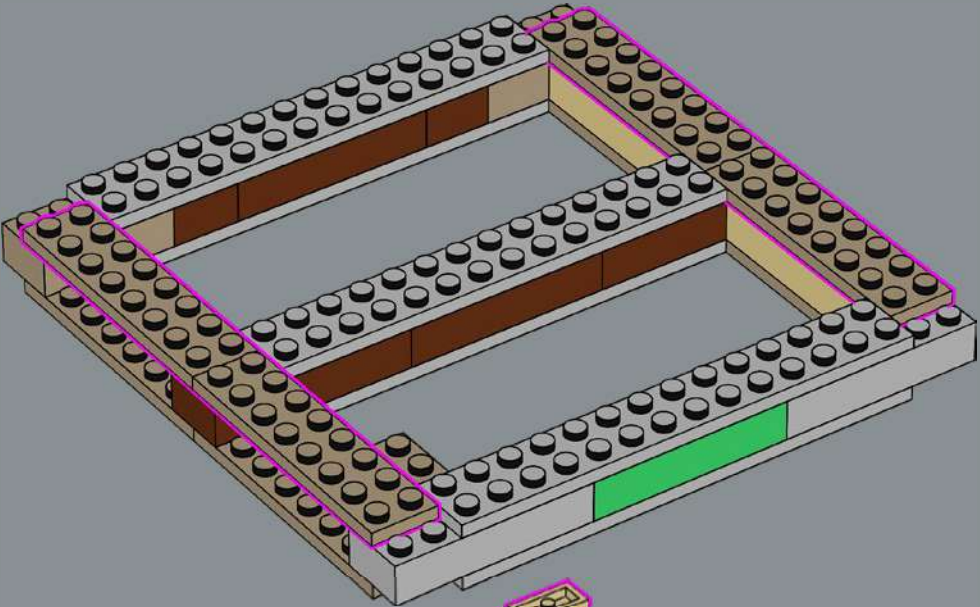

50

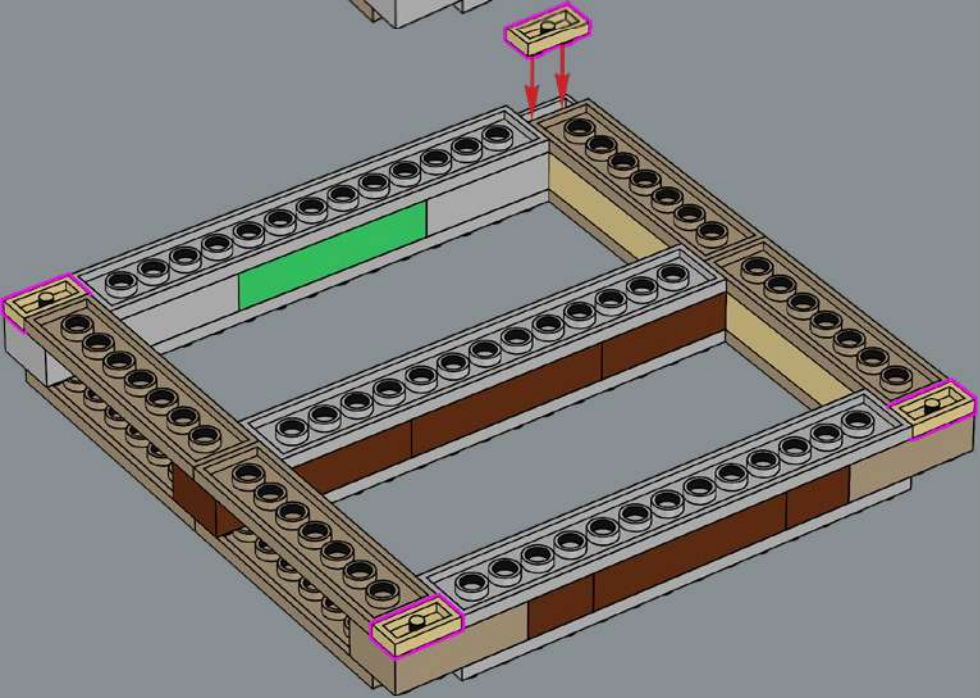



51

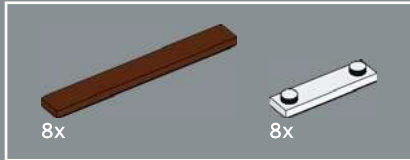
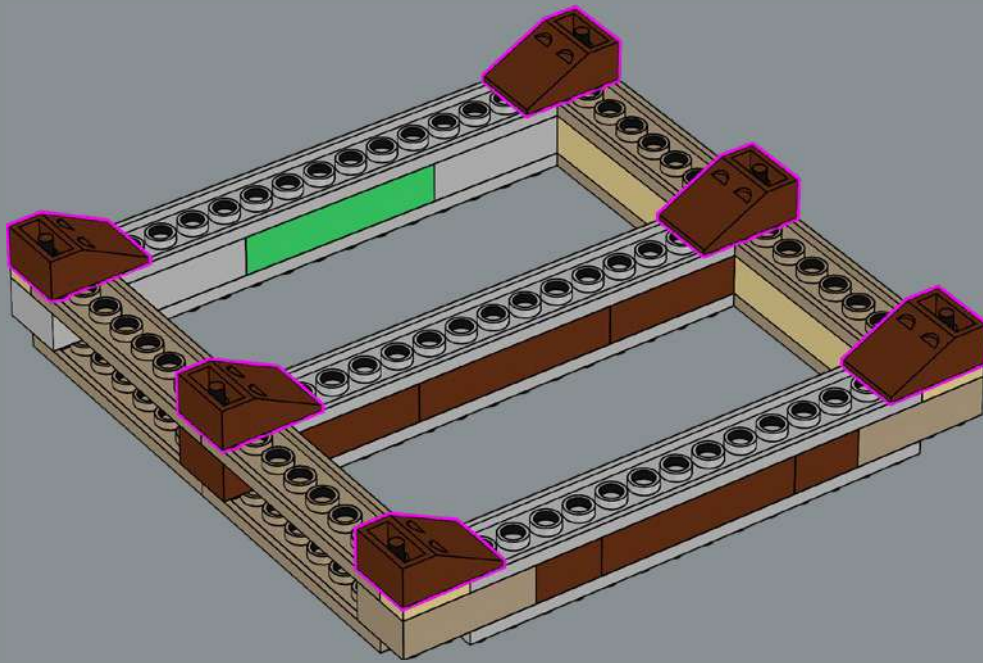

52

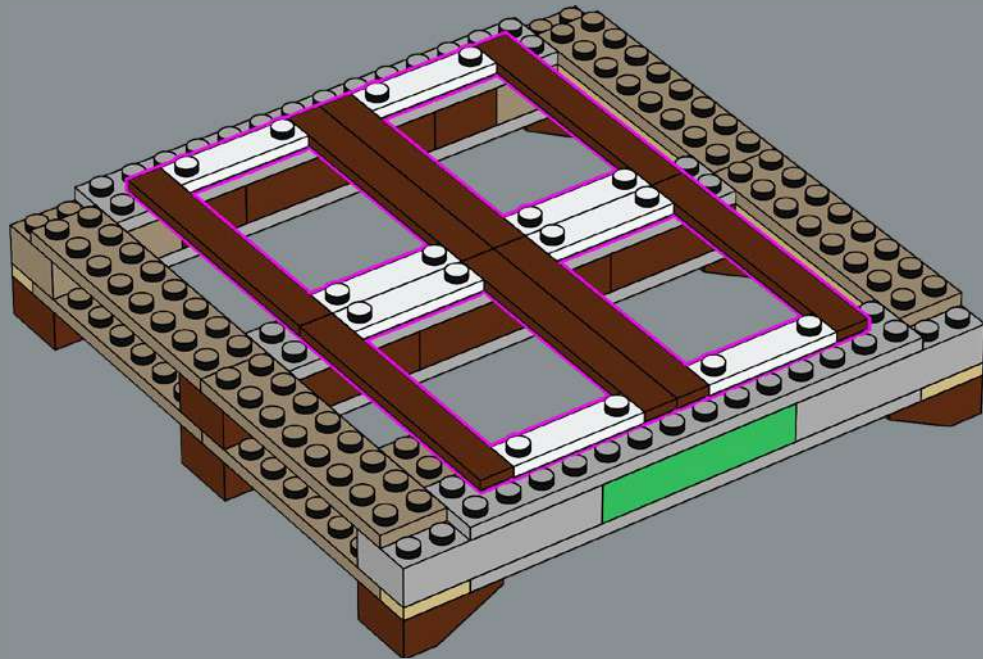



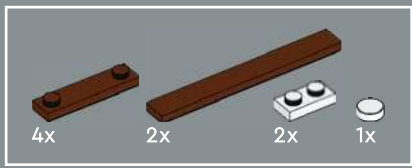

53

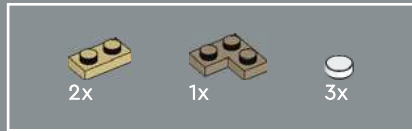
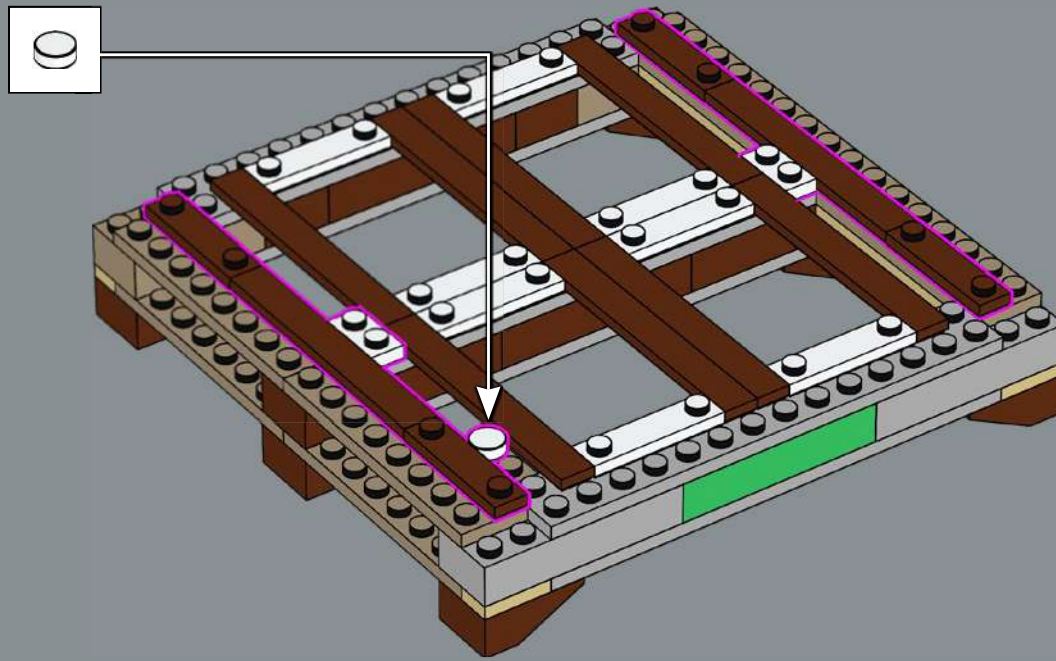

54

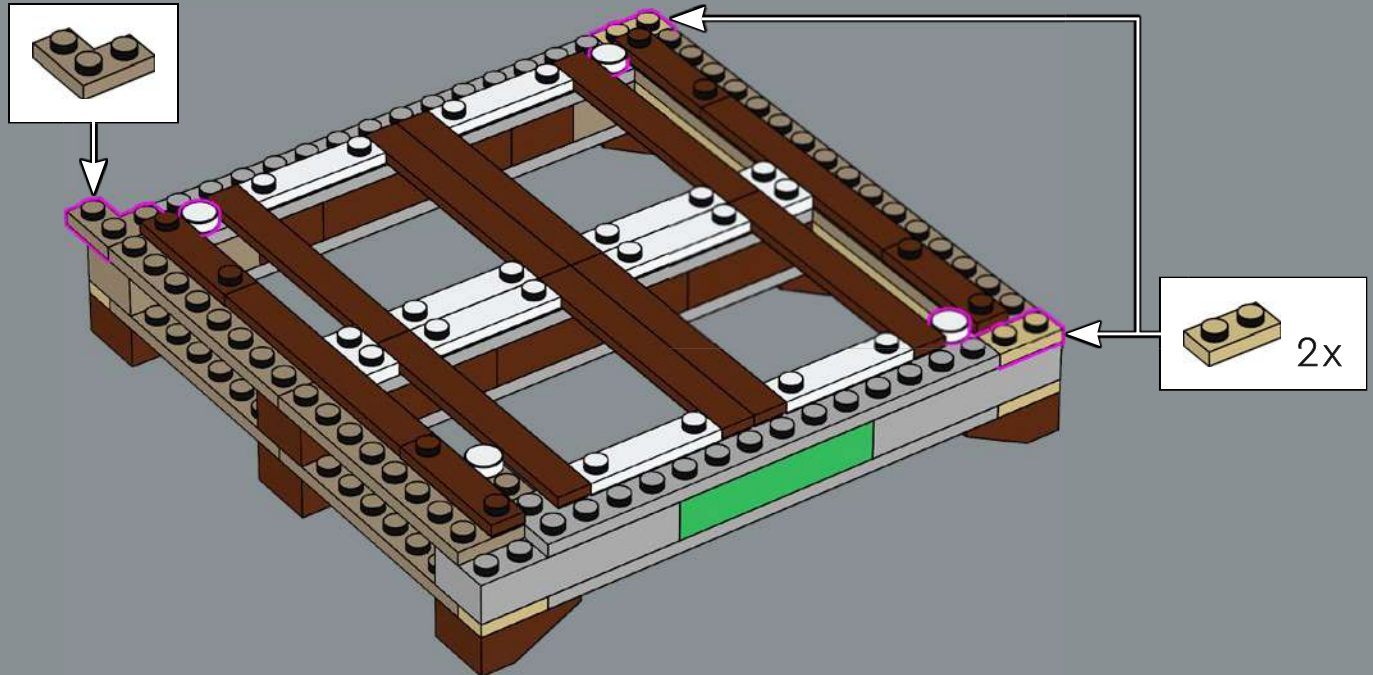

55

The castle in the model is supported by a brick-built tray, which was designed to evoke the brown and white decor seen throughout the castle interior.

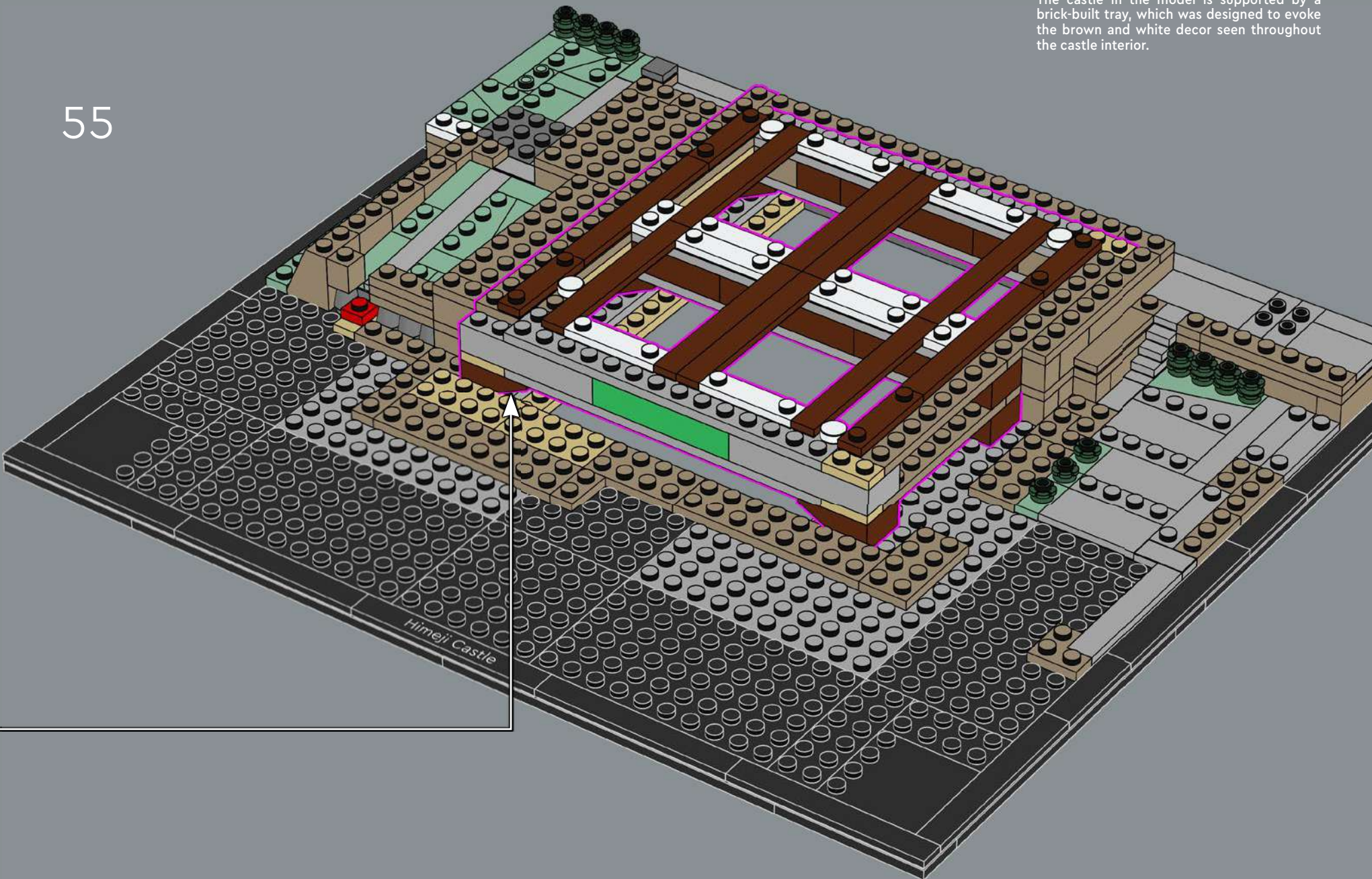



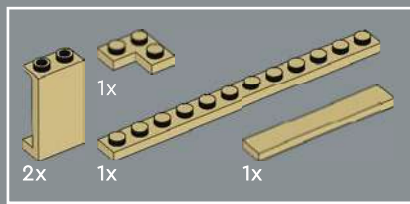

56

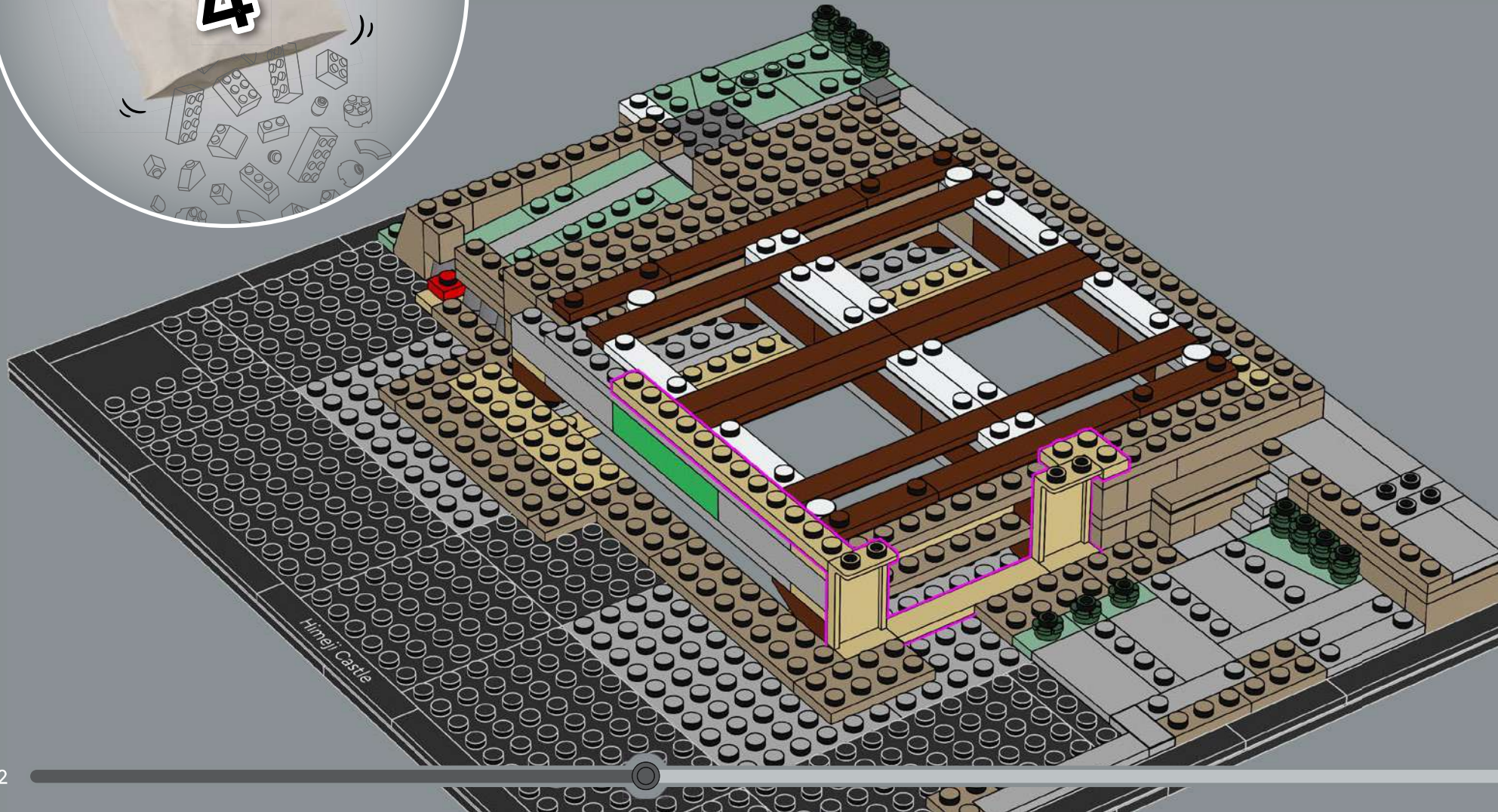



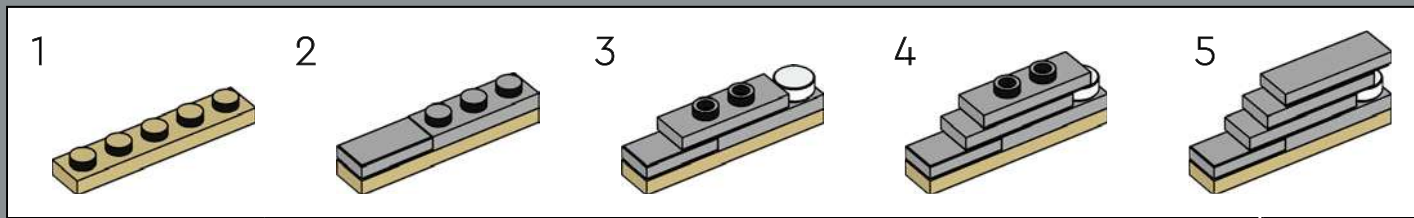
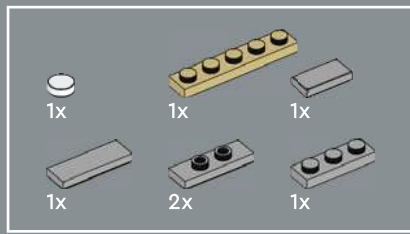

57

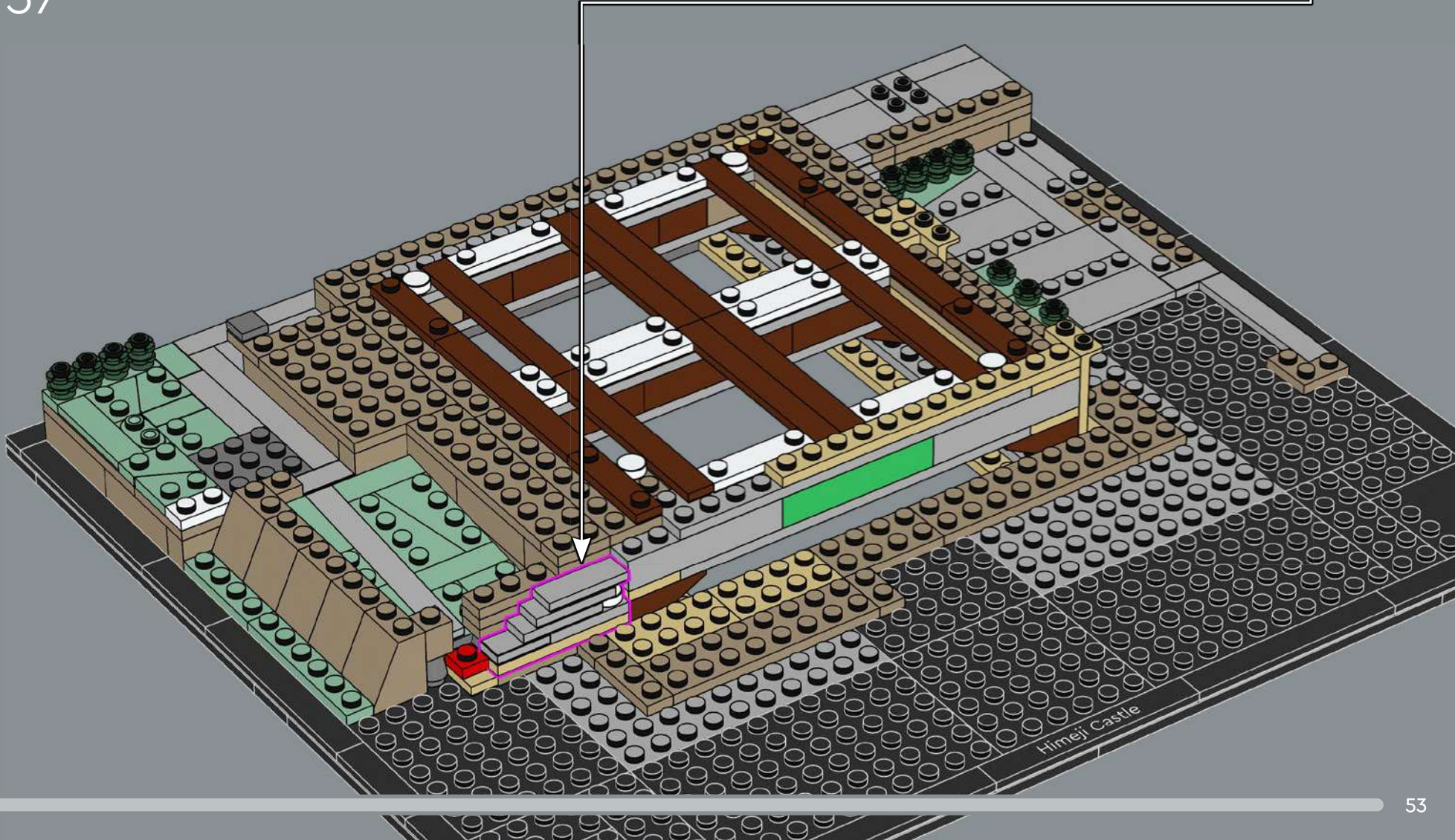



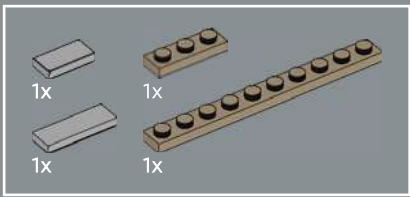

58

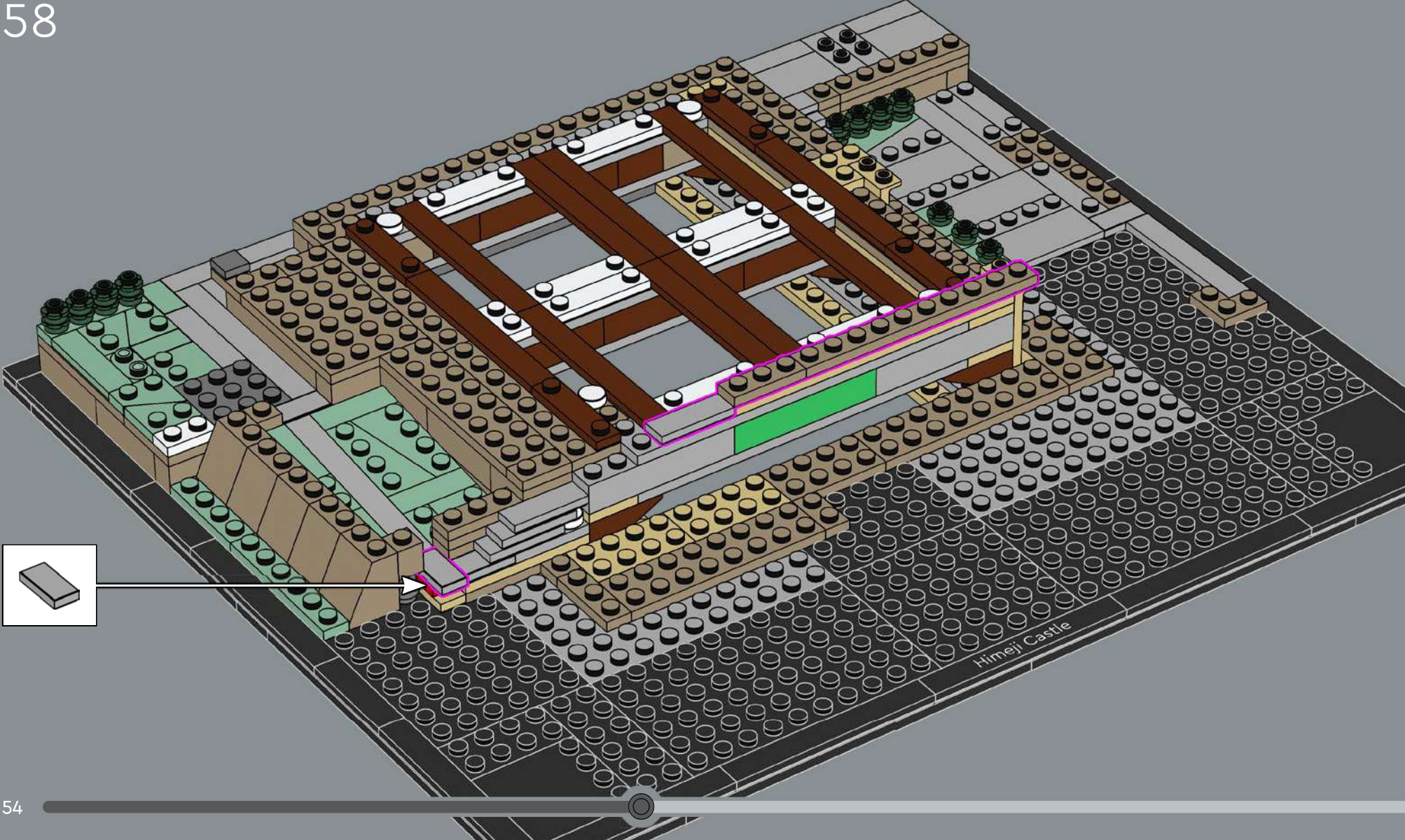



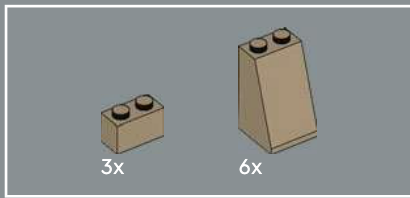

59

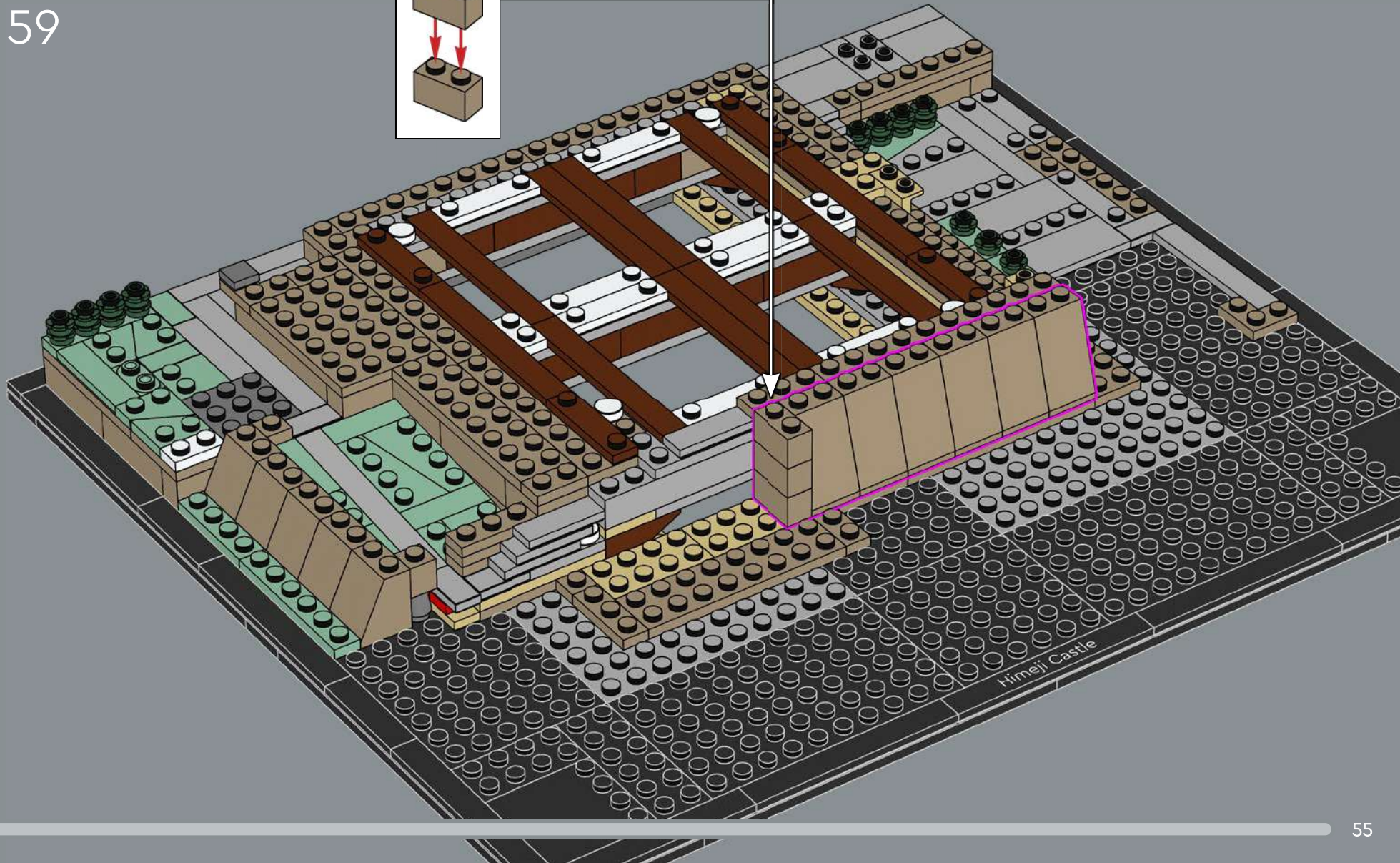
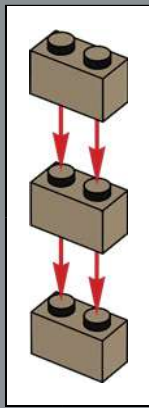



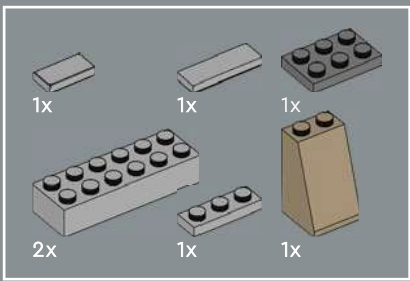

60

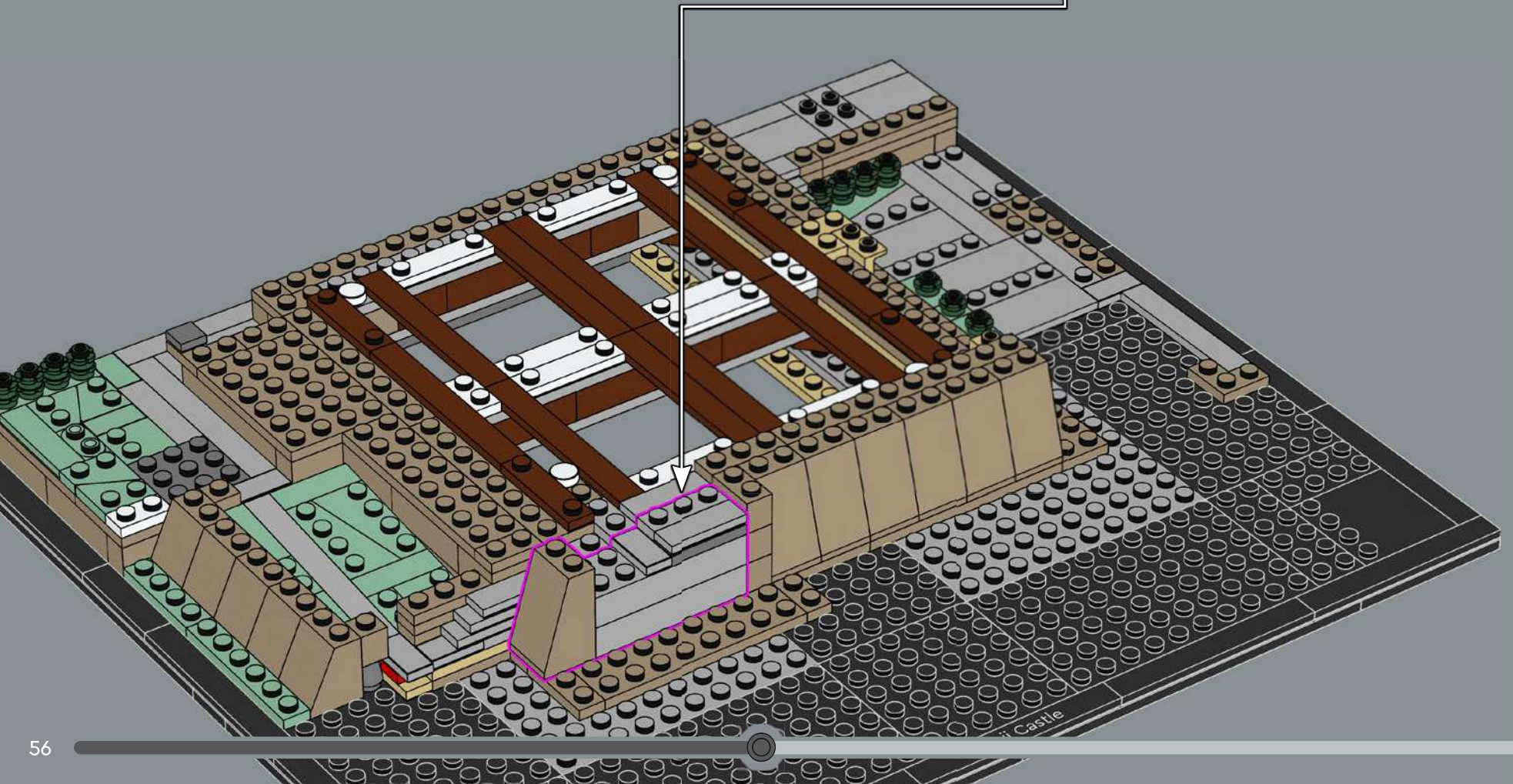
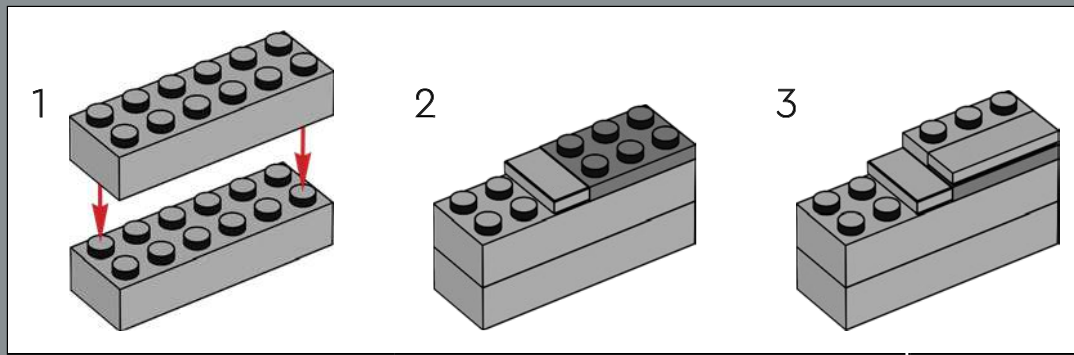



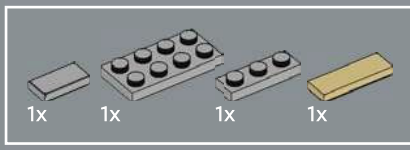

61

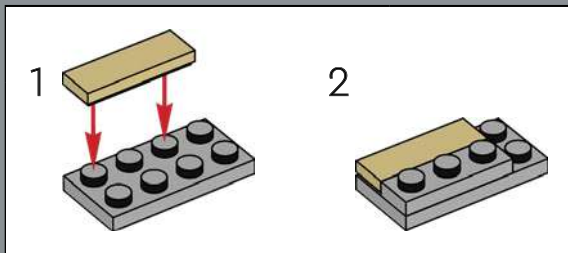
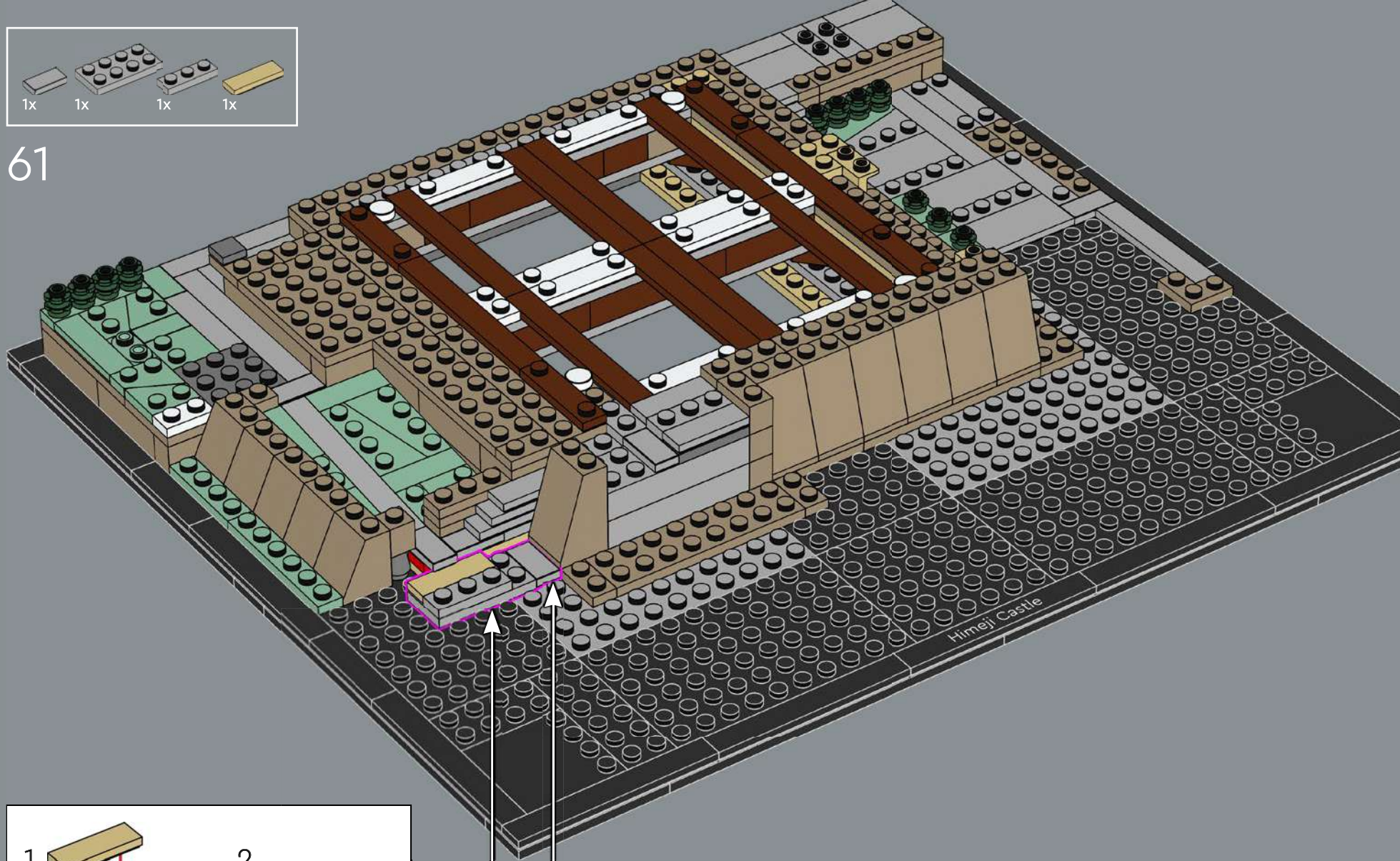



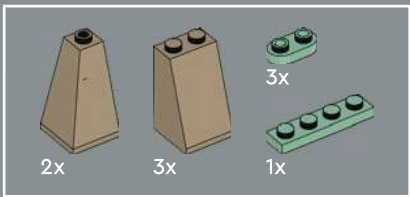

62

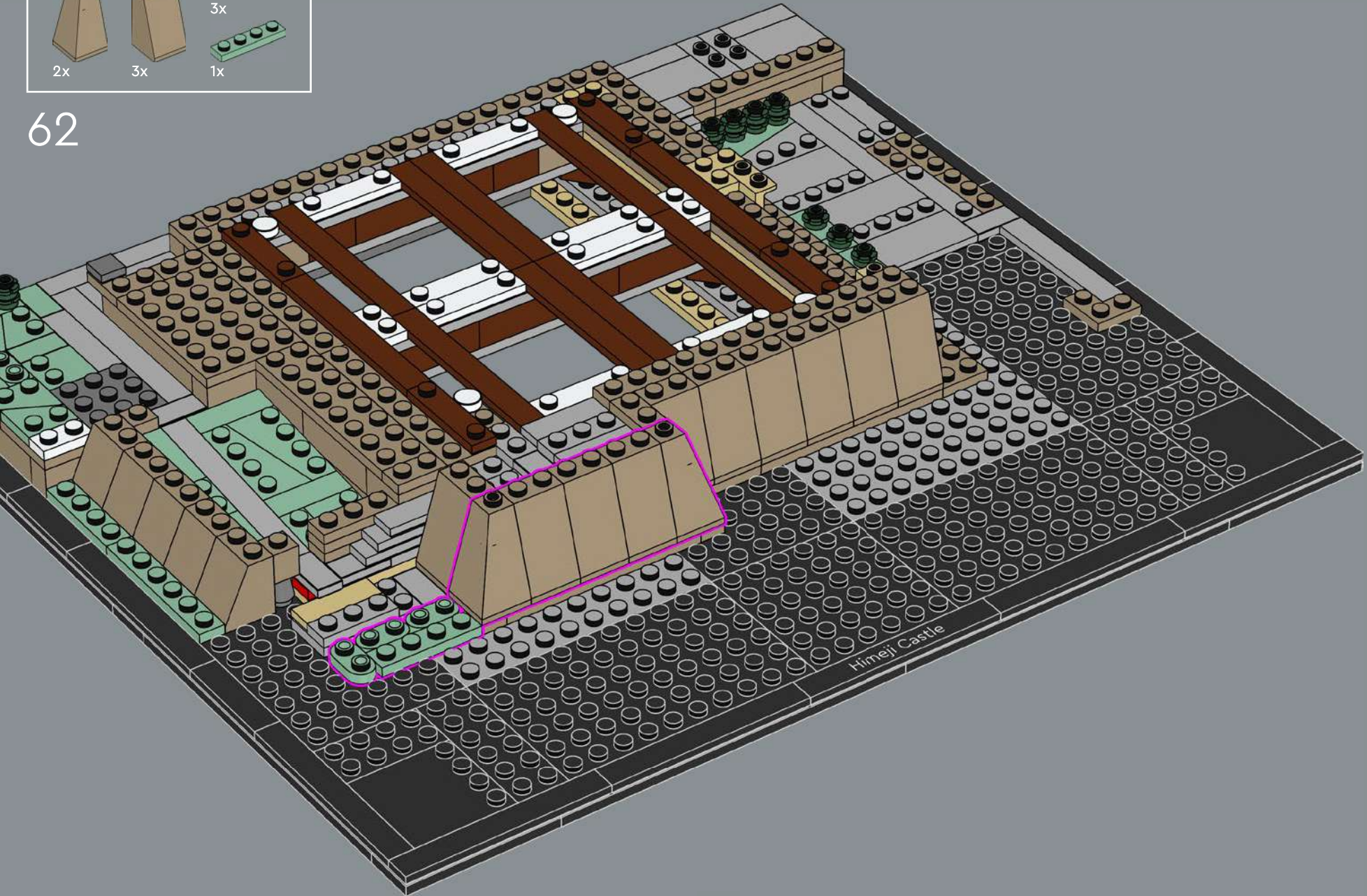



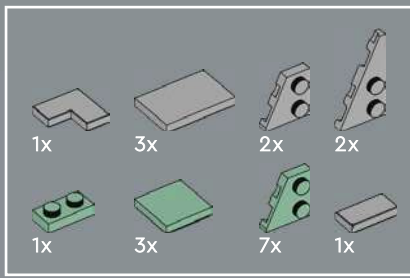

63

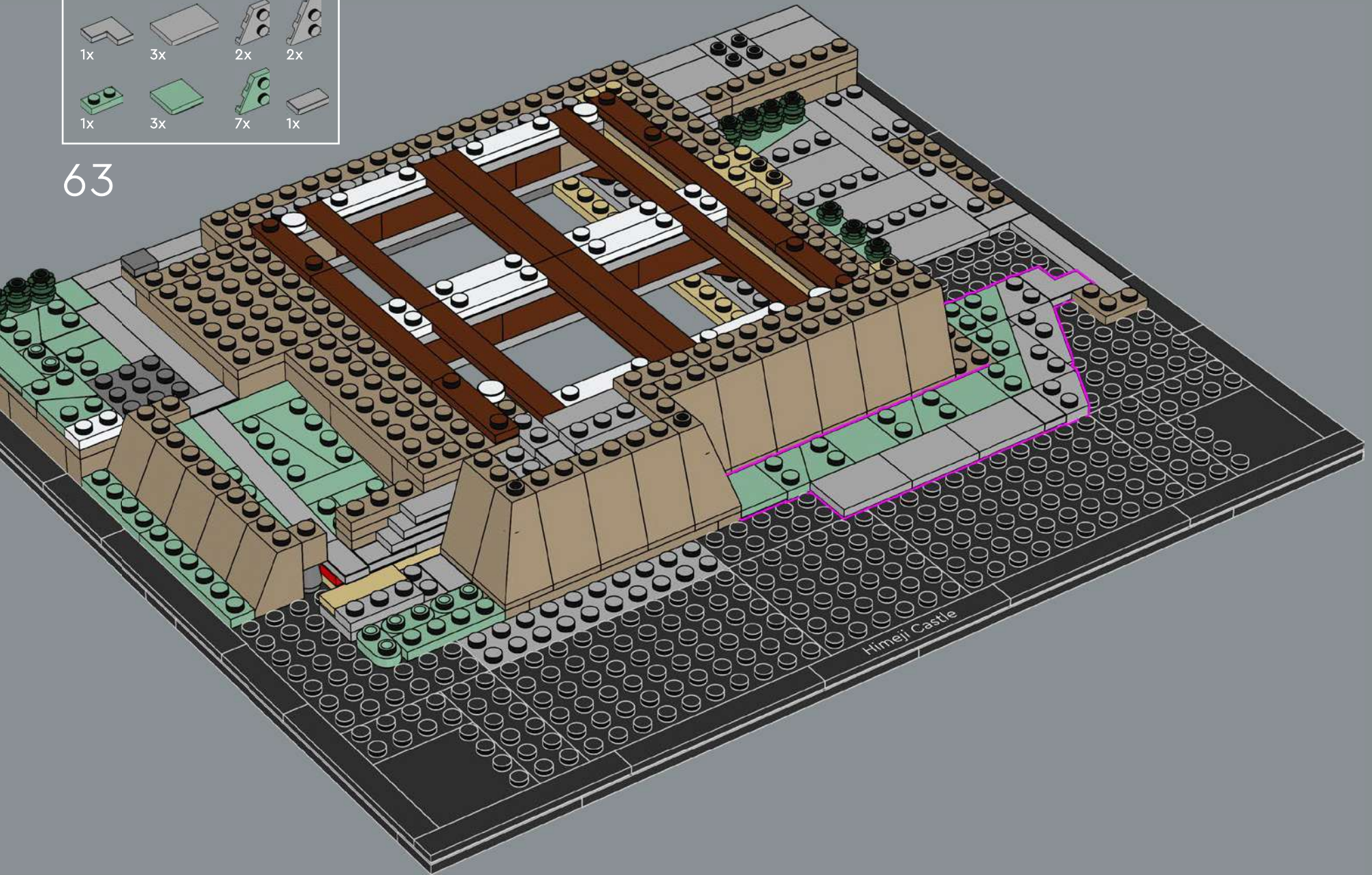



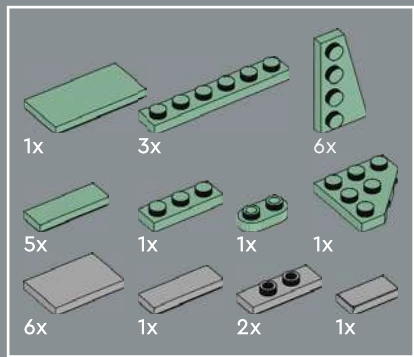

64

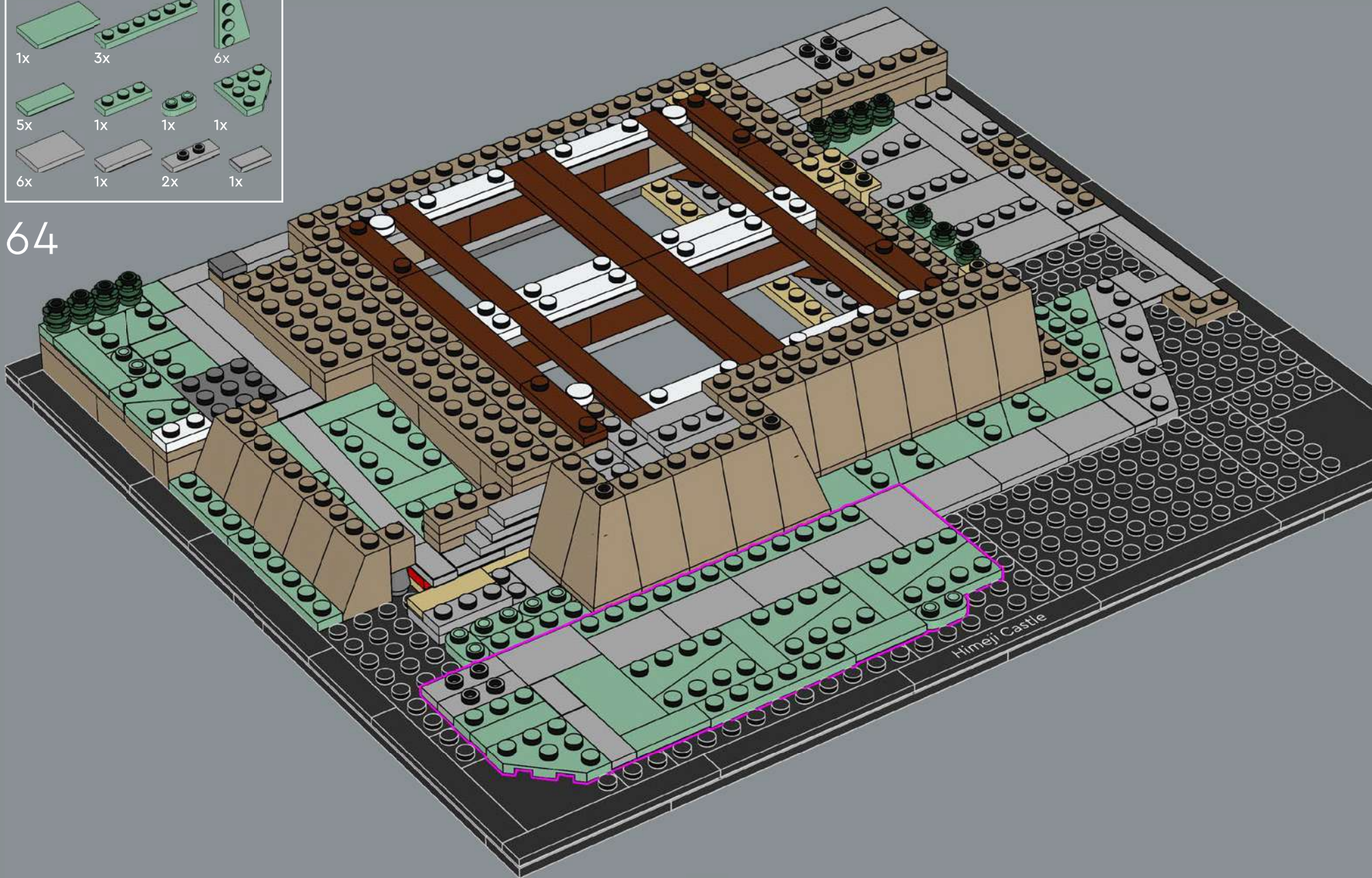



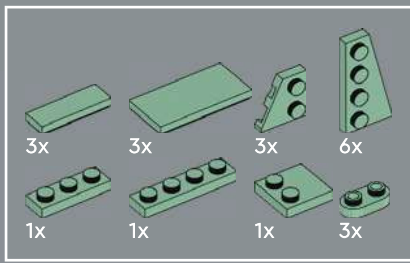

65





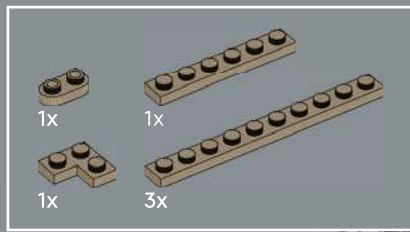

66

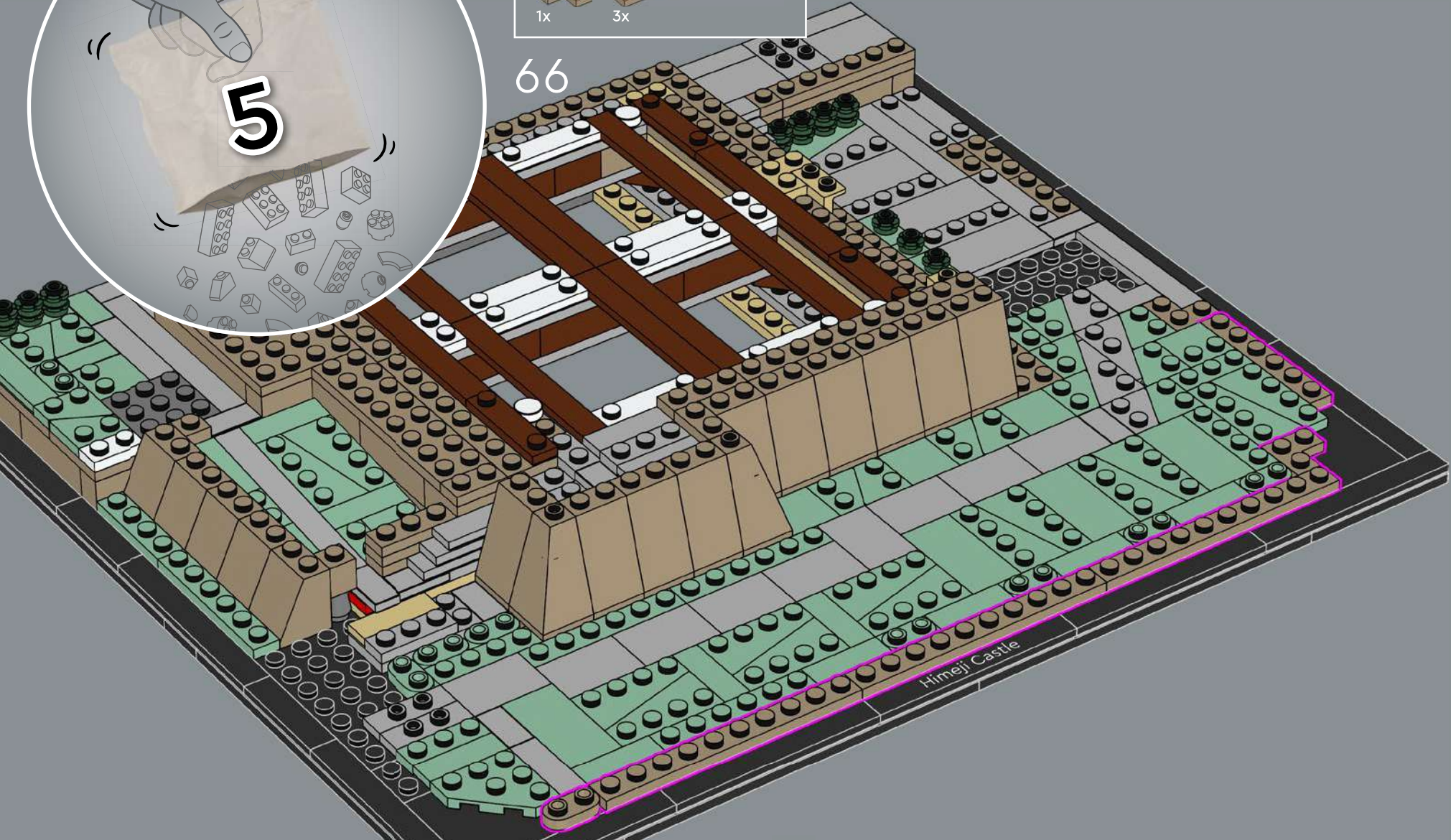



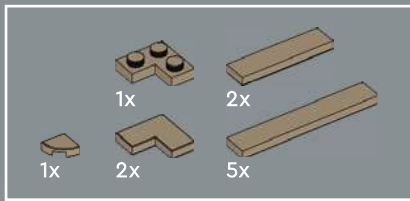

67

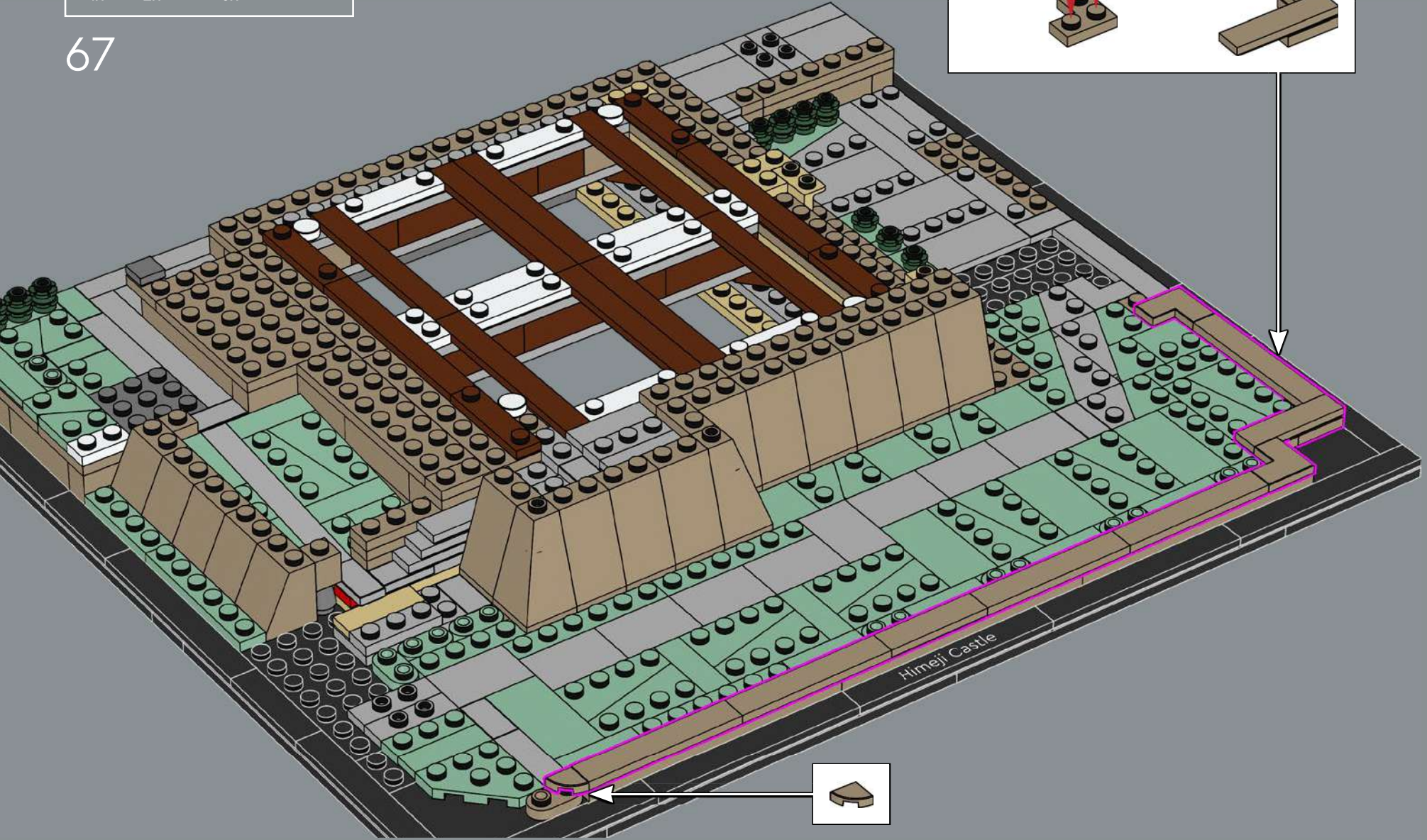
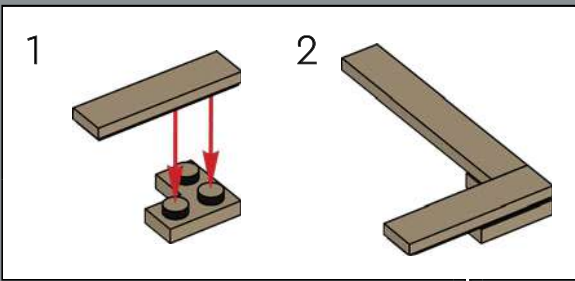



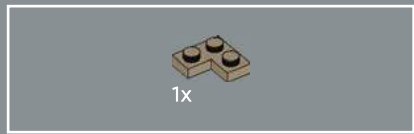

68

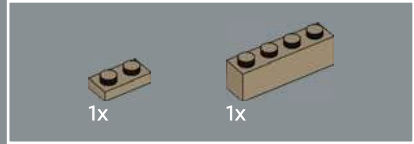

69

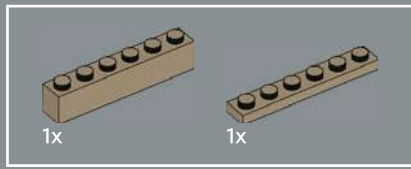
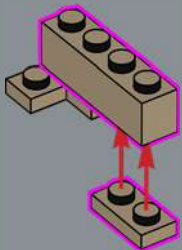

70

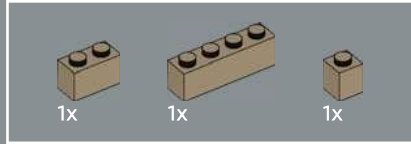
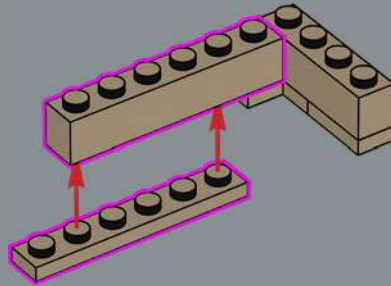

71

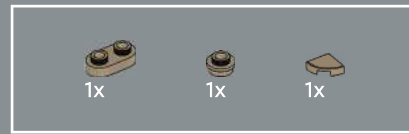
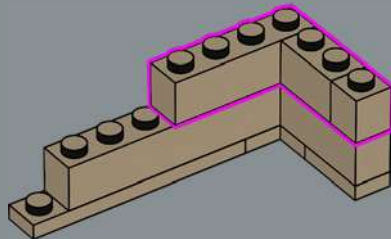

72

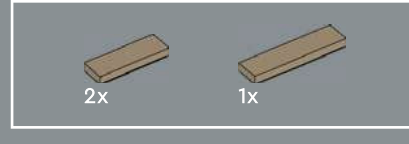
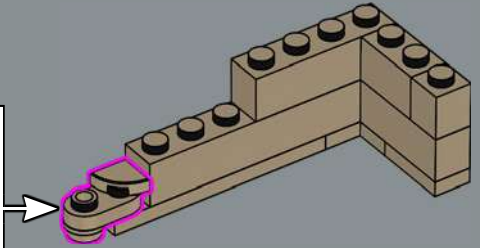
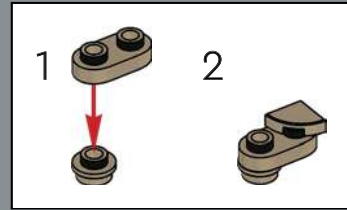

73

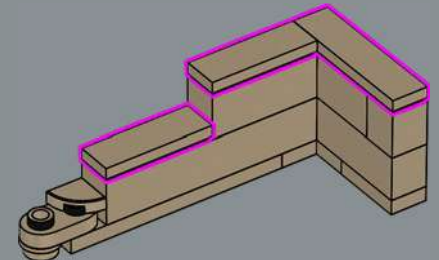

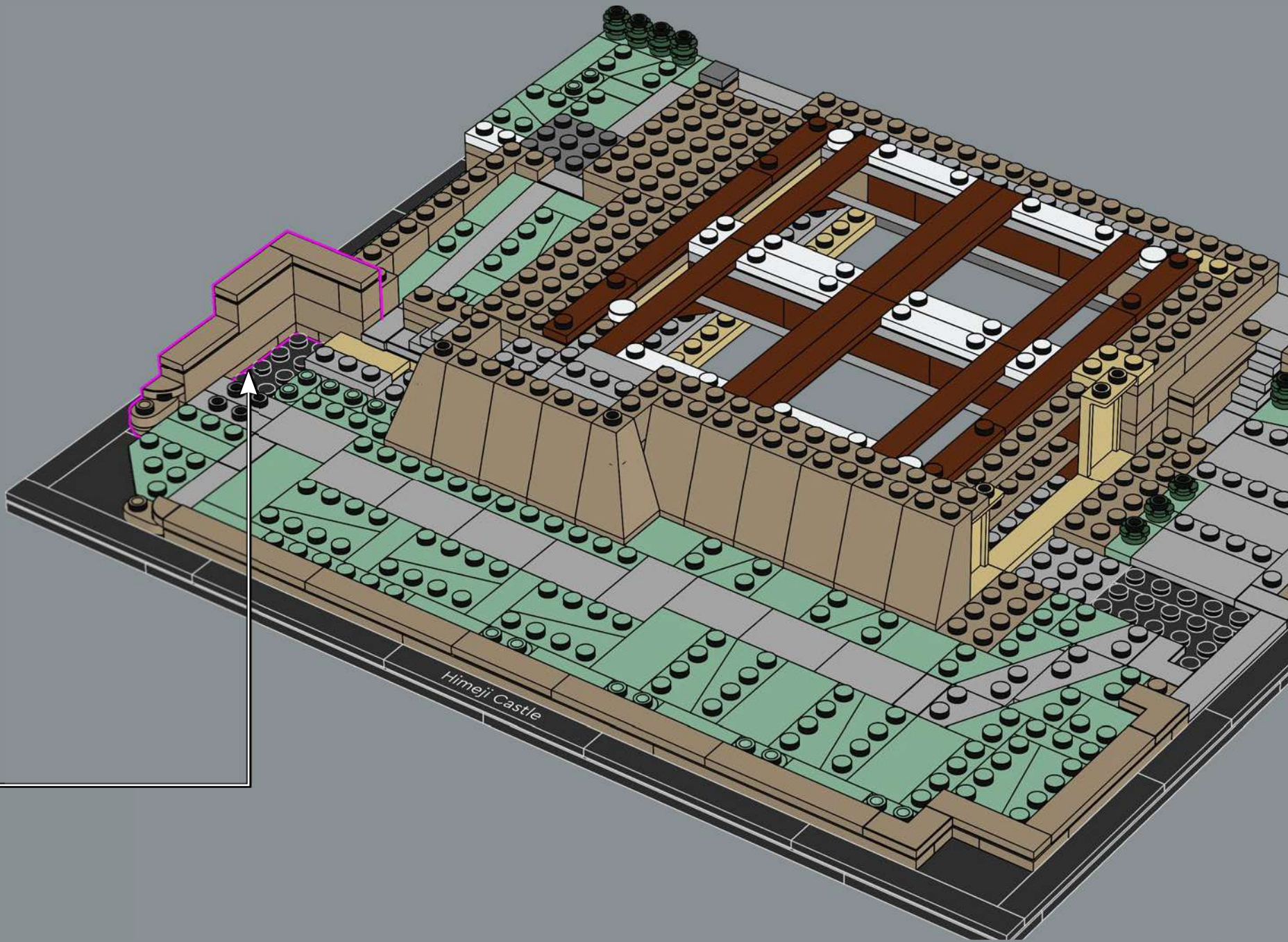



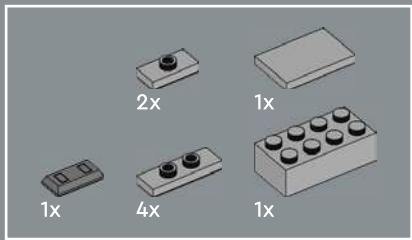

75

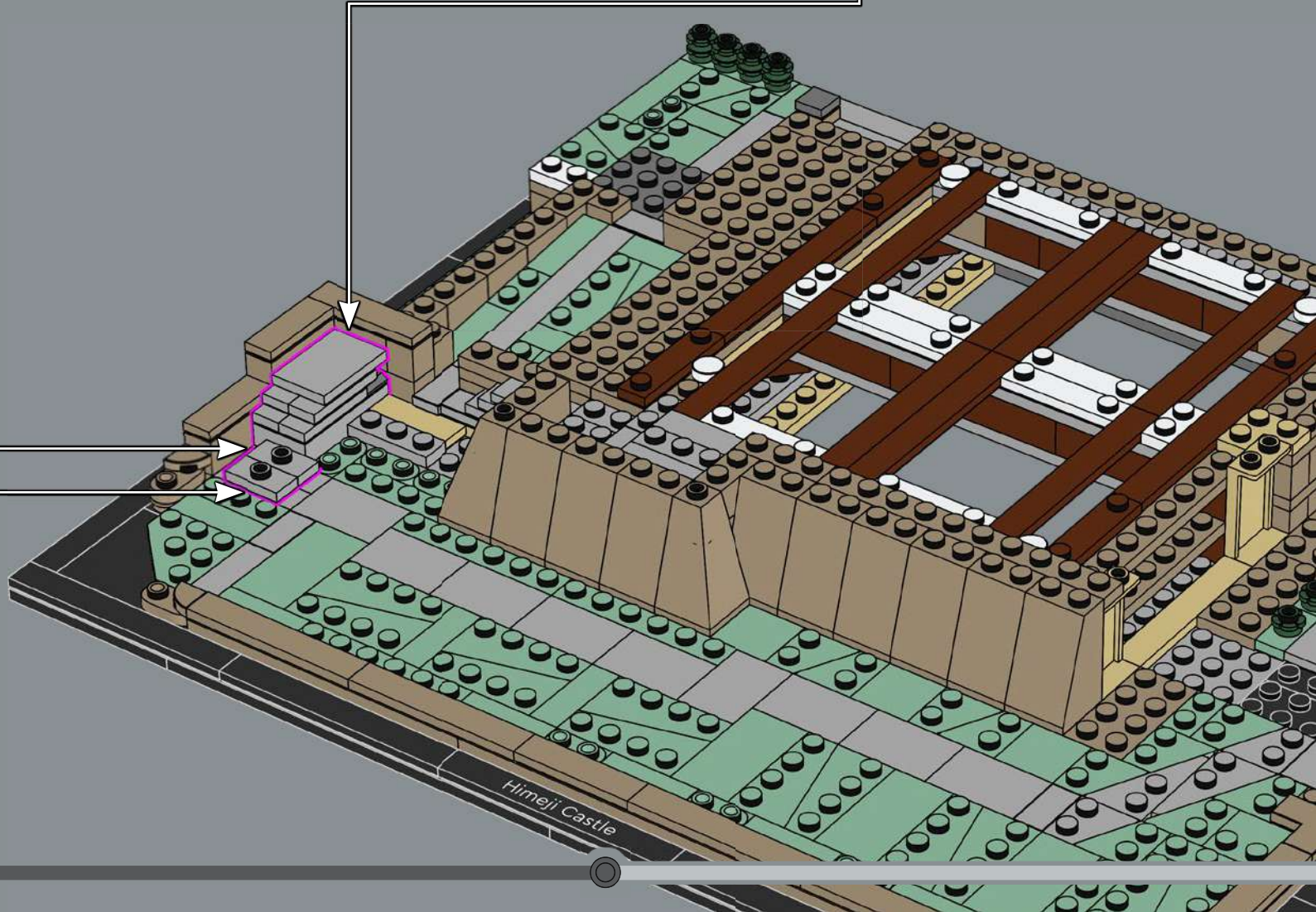
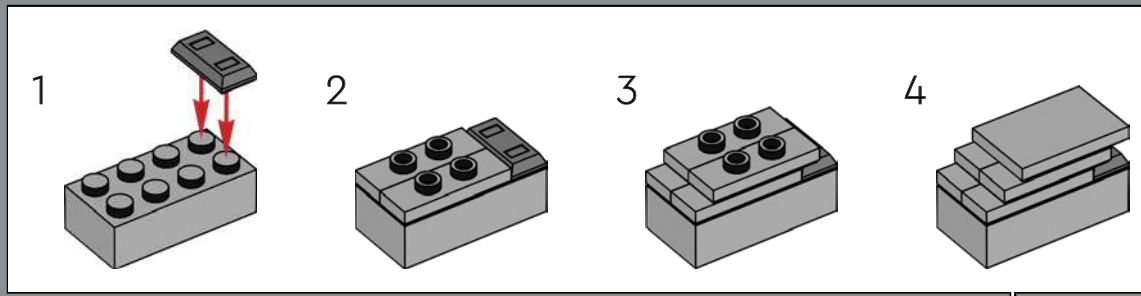

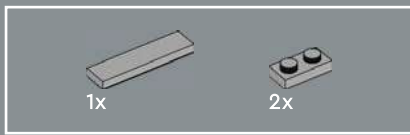

76

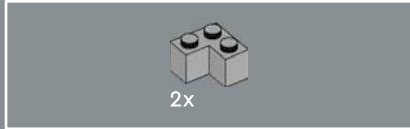
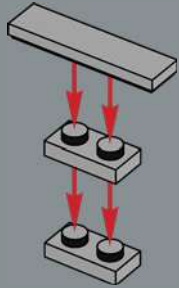

77

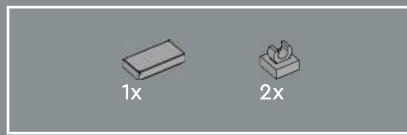
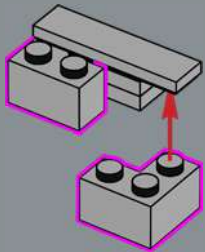

78

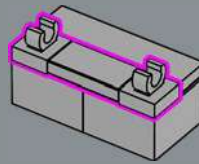

79

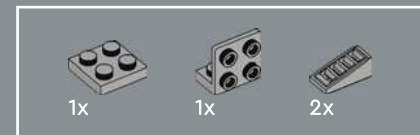
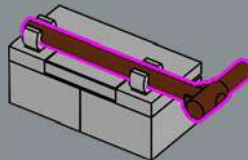

80

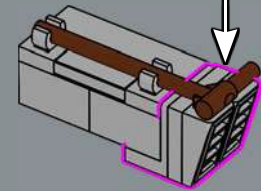
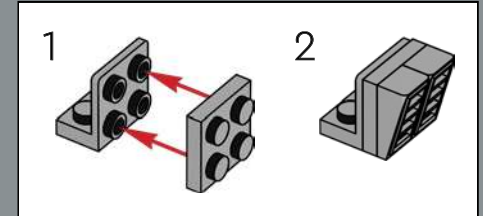



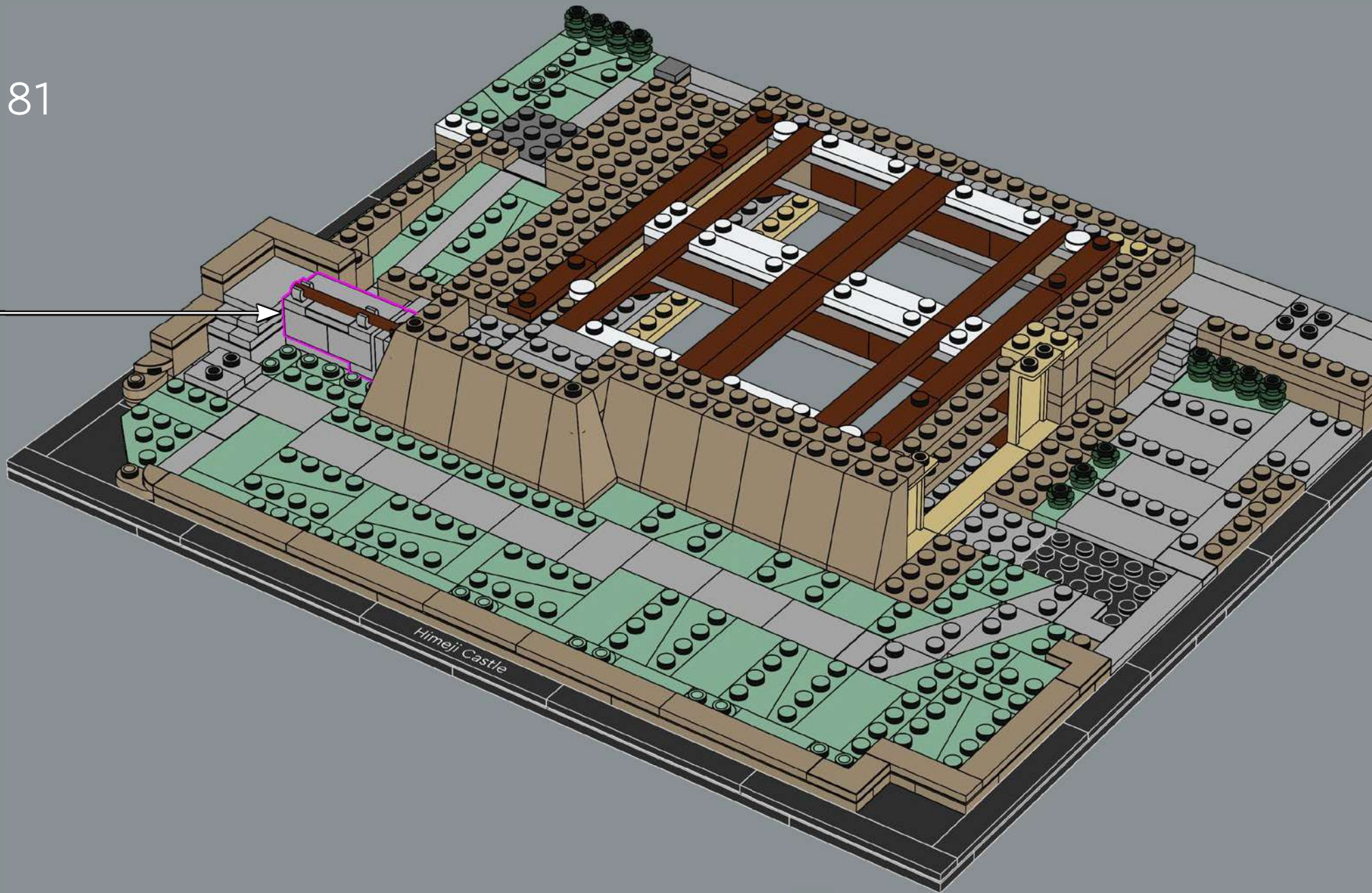



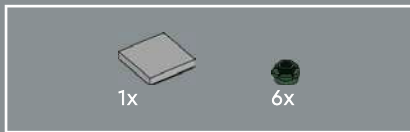

82

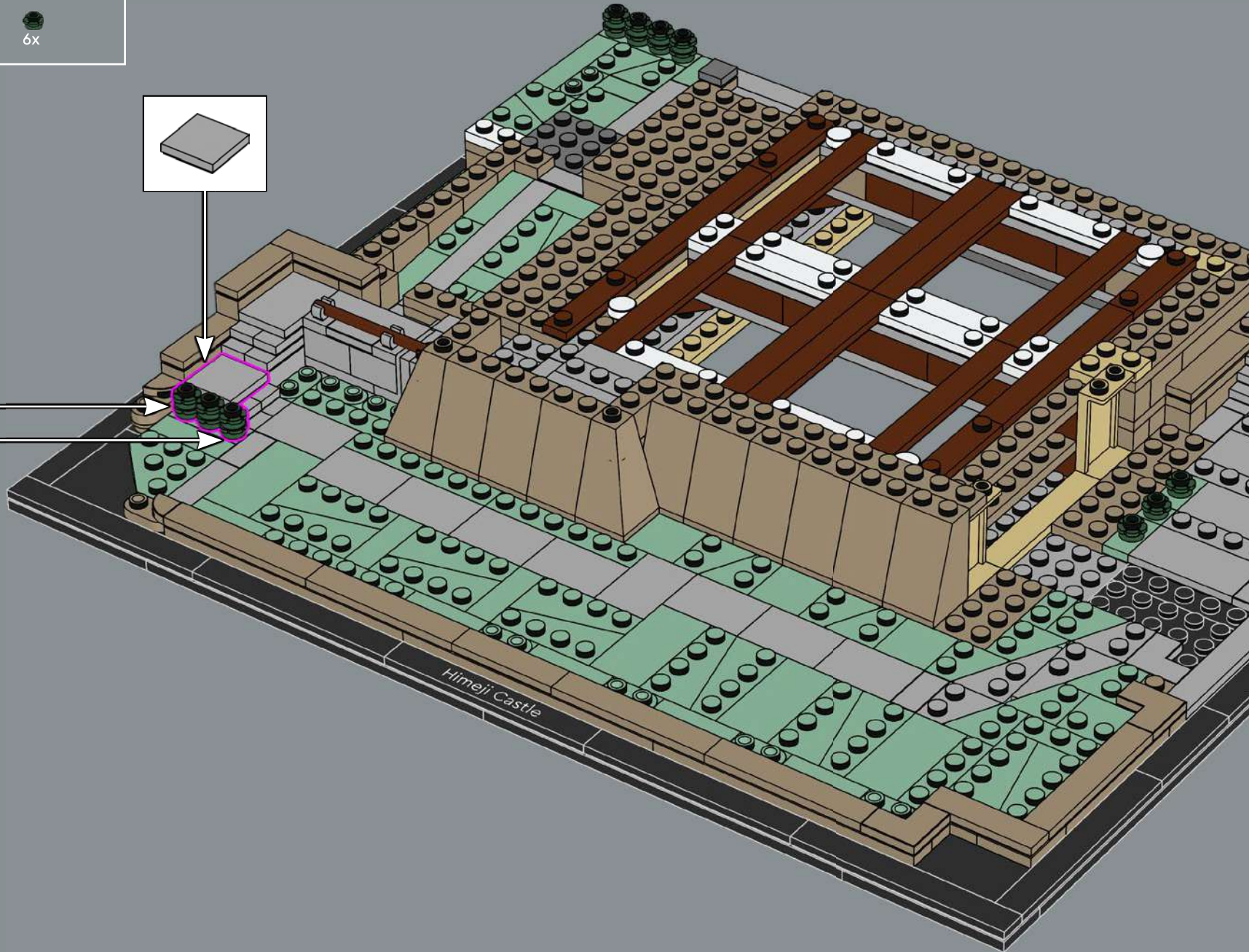
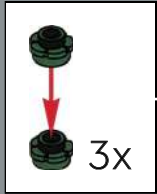
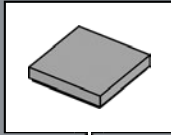



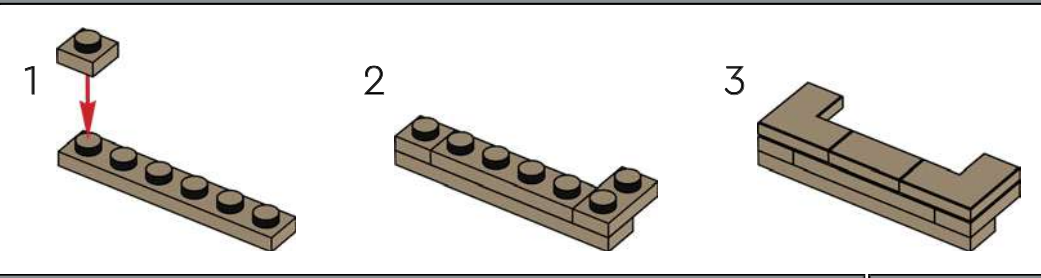
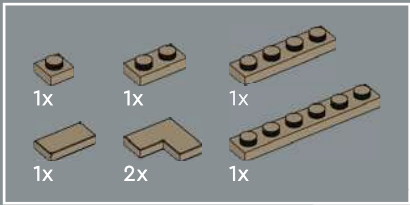

83

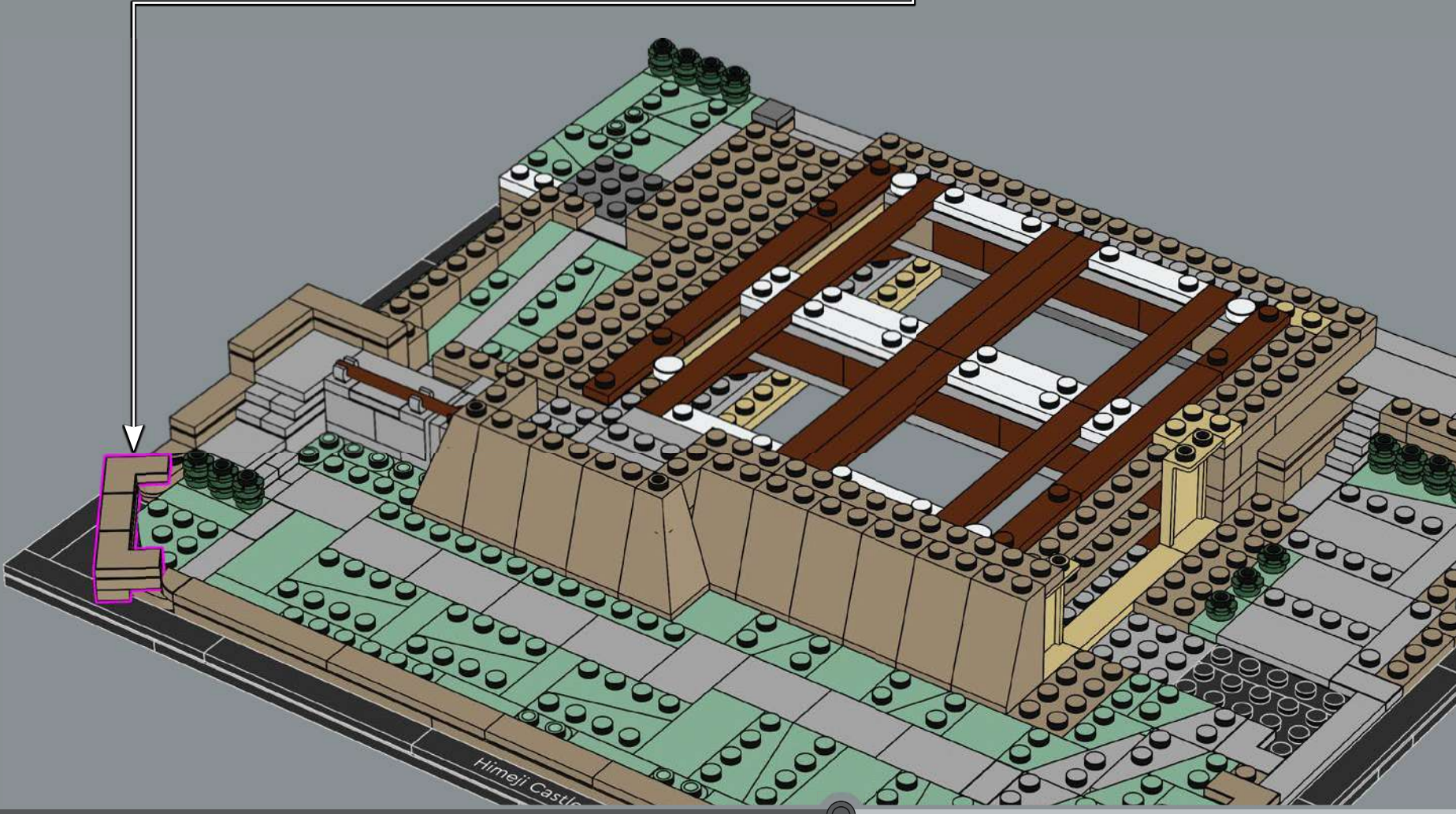

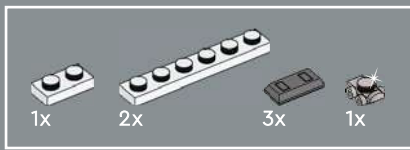

84

1

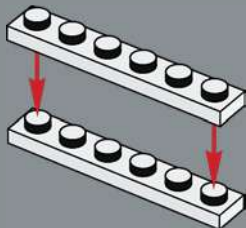

2

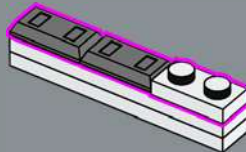

3

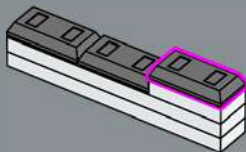

4



1:1

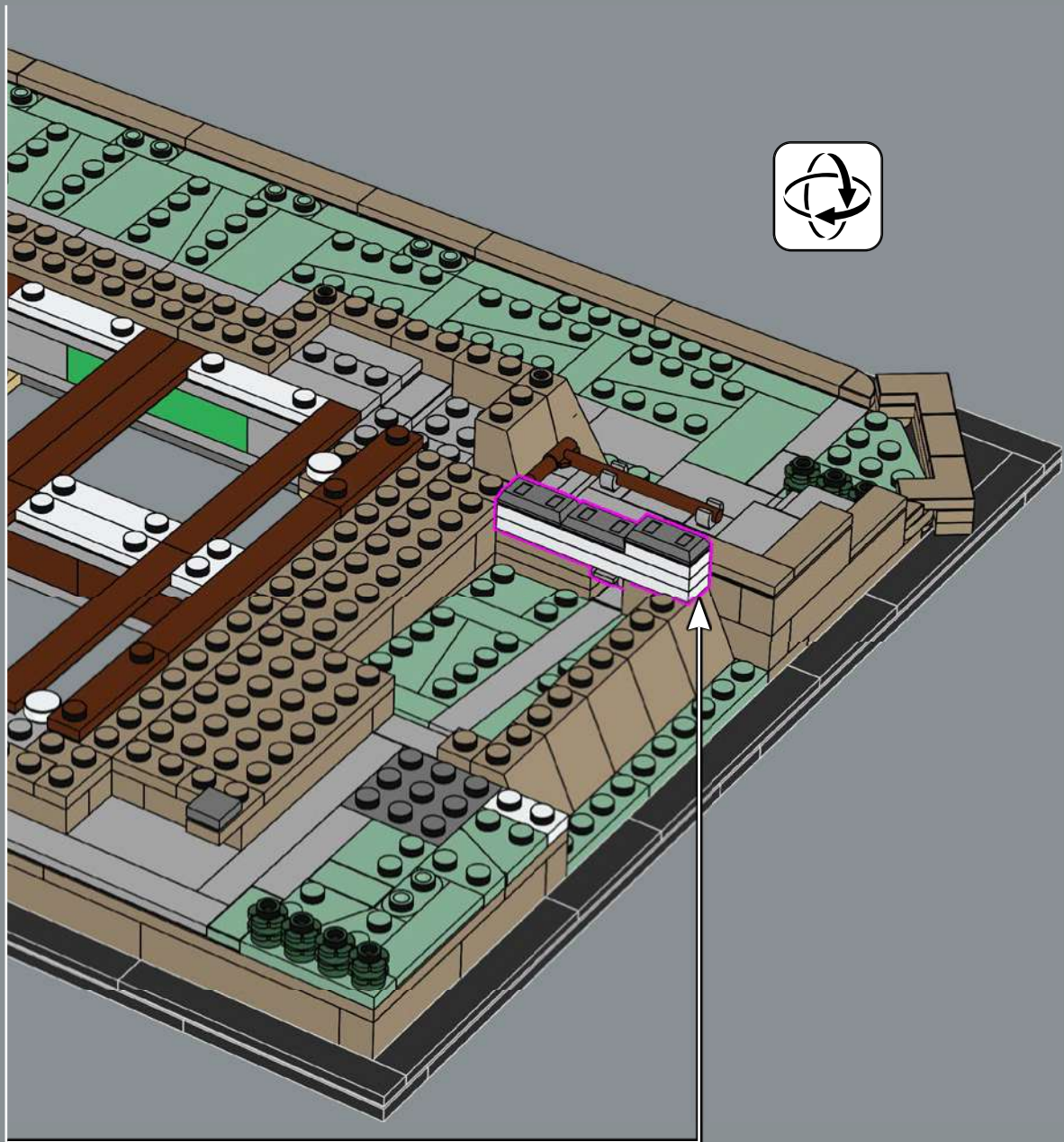
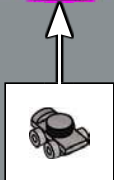



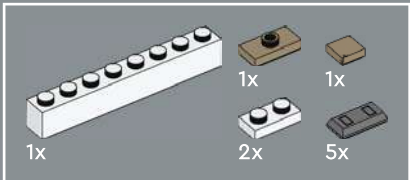

85

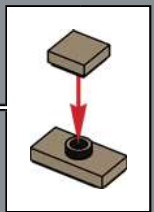
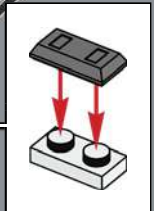
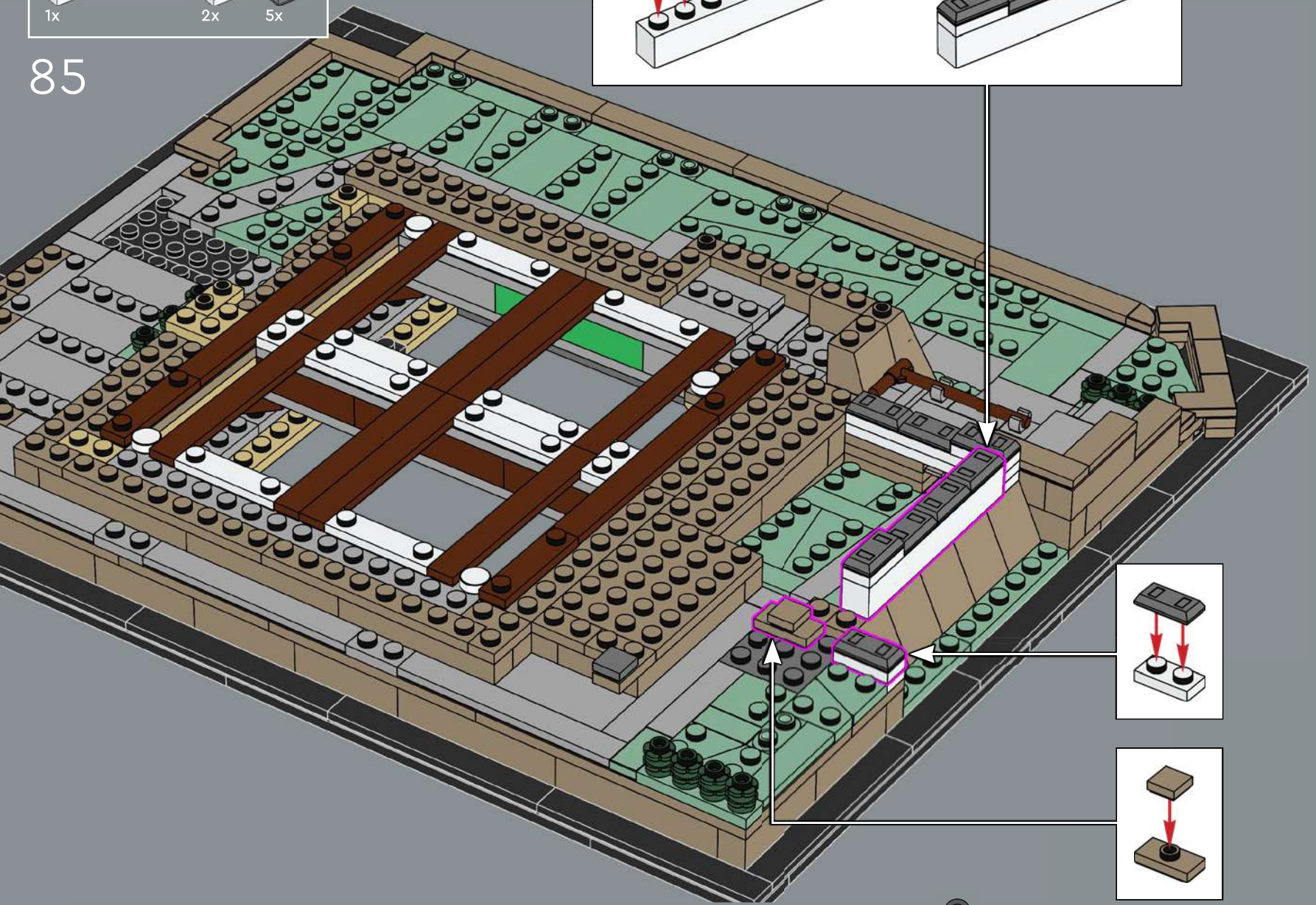
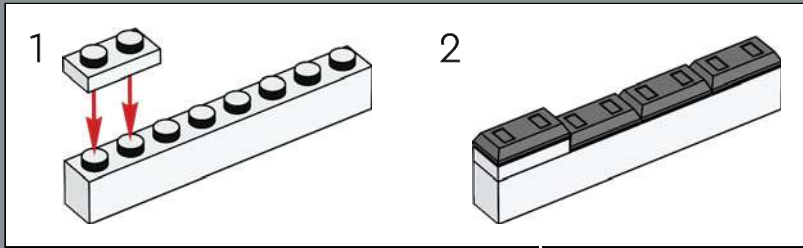

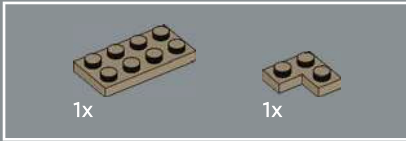
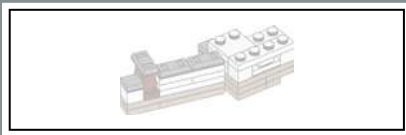

86

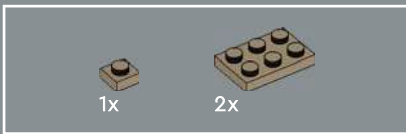
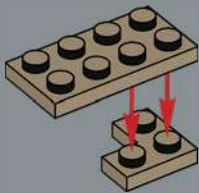

87

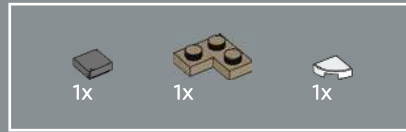
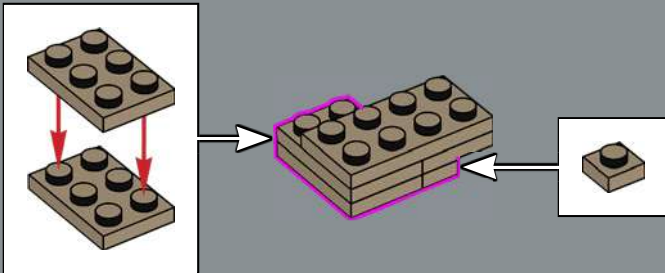

88

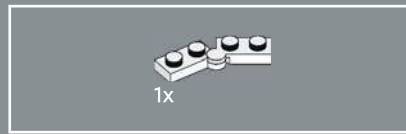
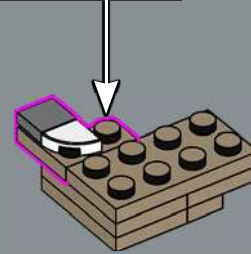
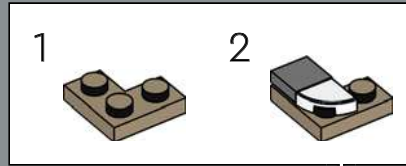

89

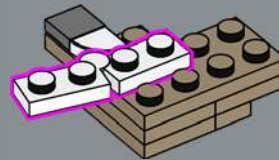

90

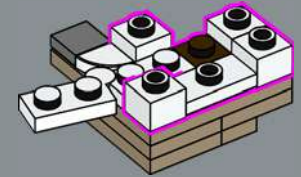

91

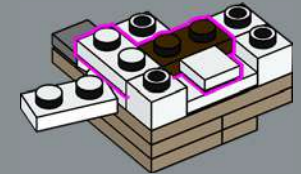



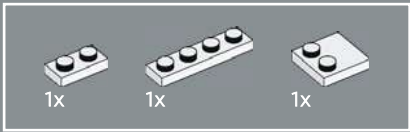

92

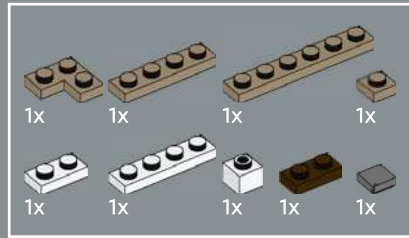
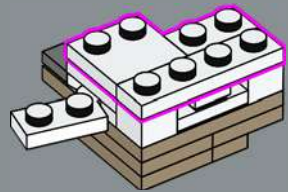

93

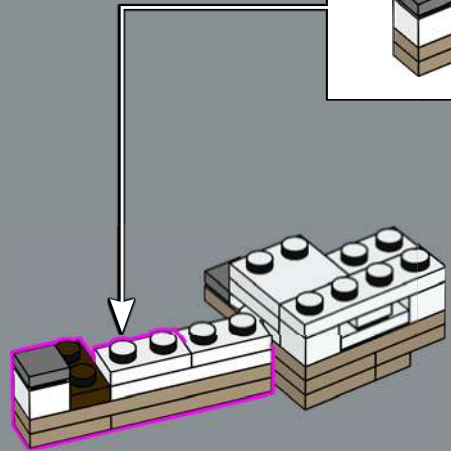
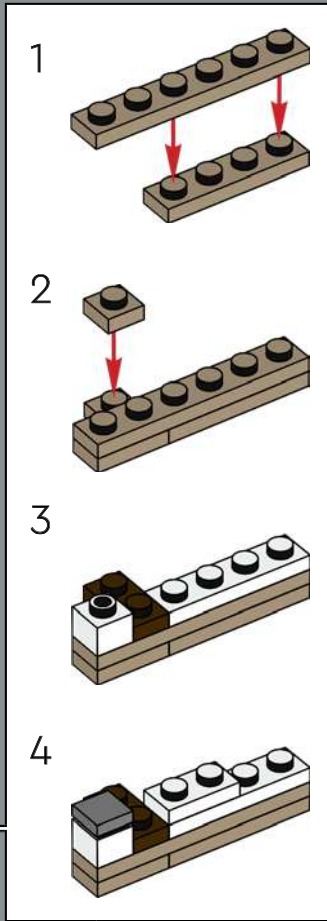

94

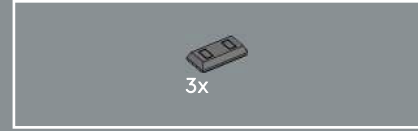
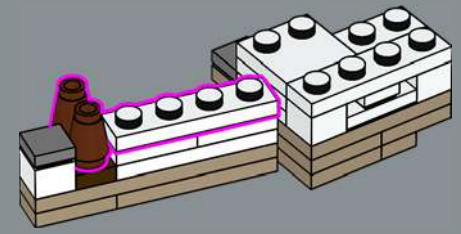

95

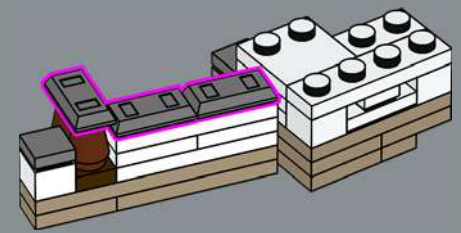

One of the features that make the castle's architecture so interesting is that many of the walls, towers and pathways are placed at irregular angles.

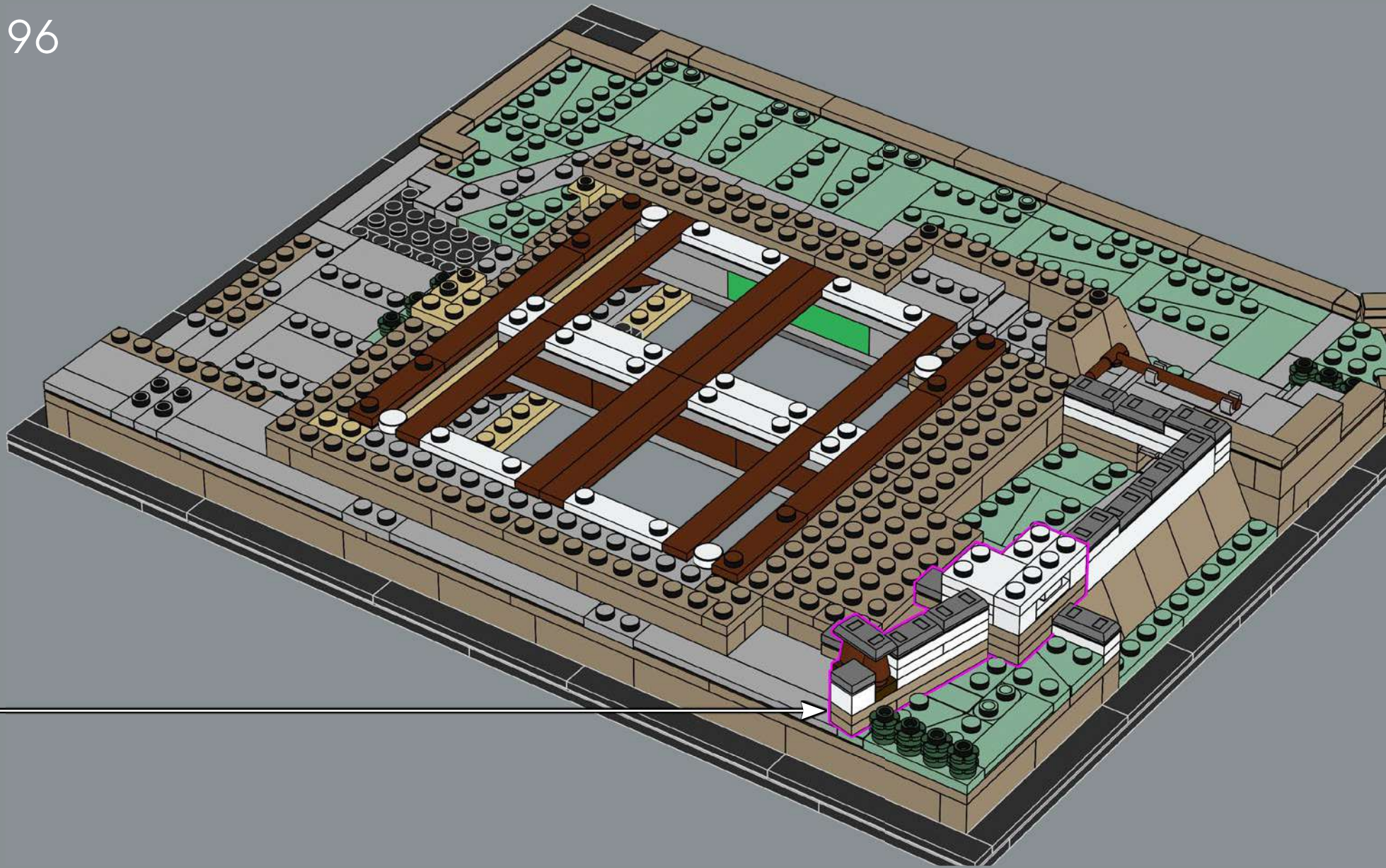



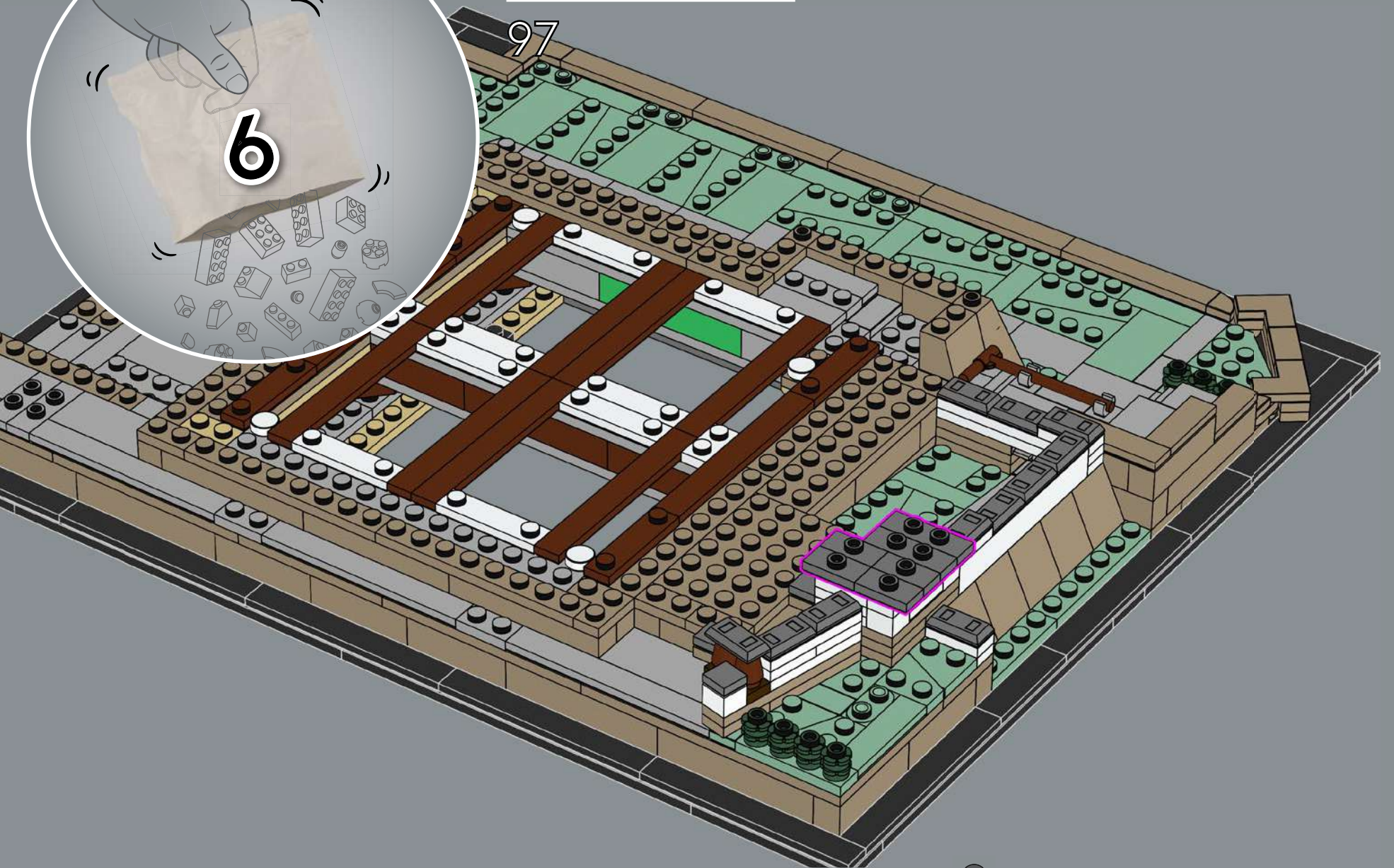
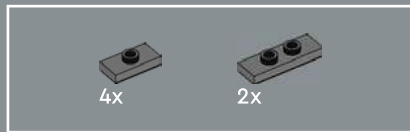



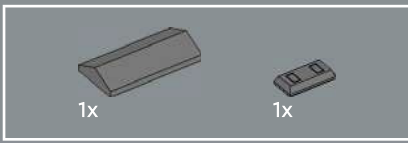

98

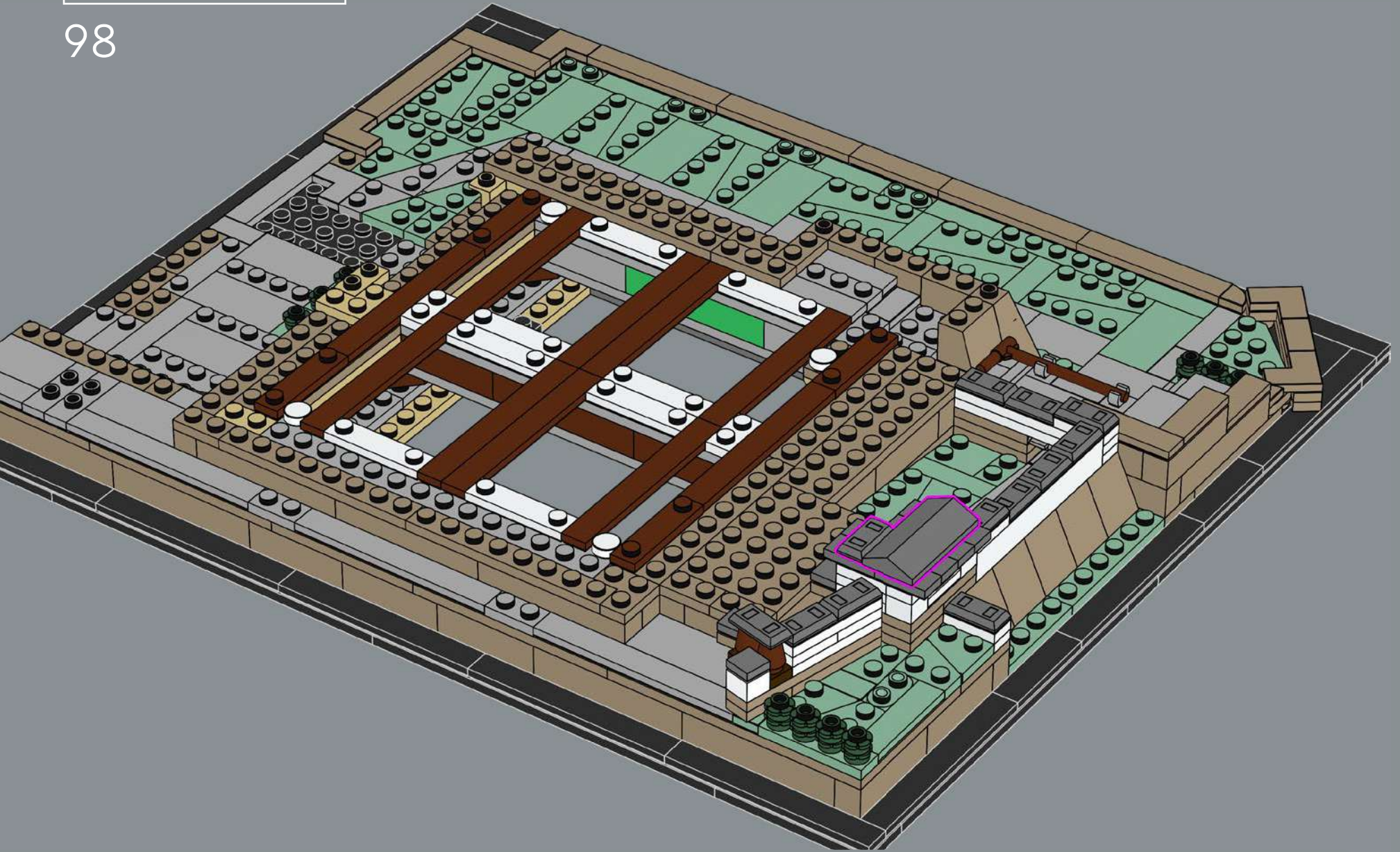



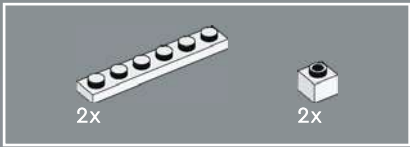

99

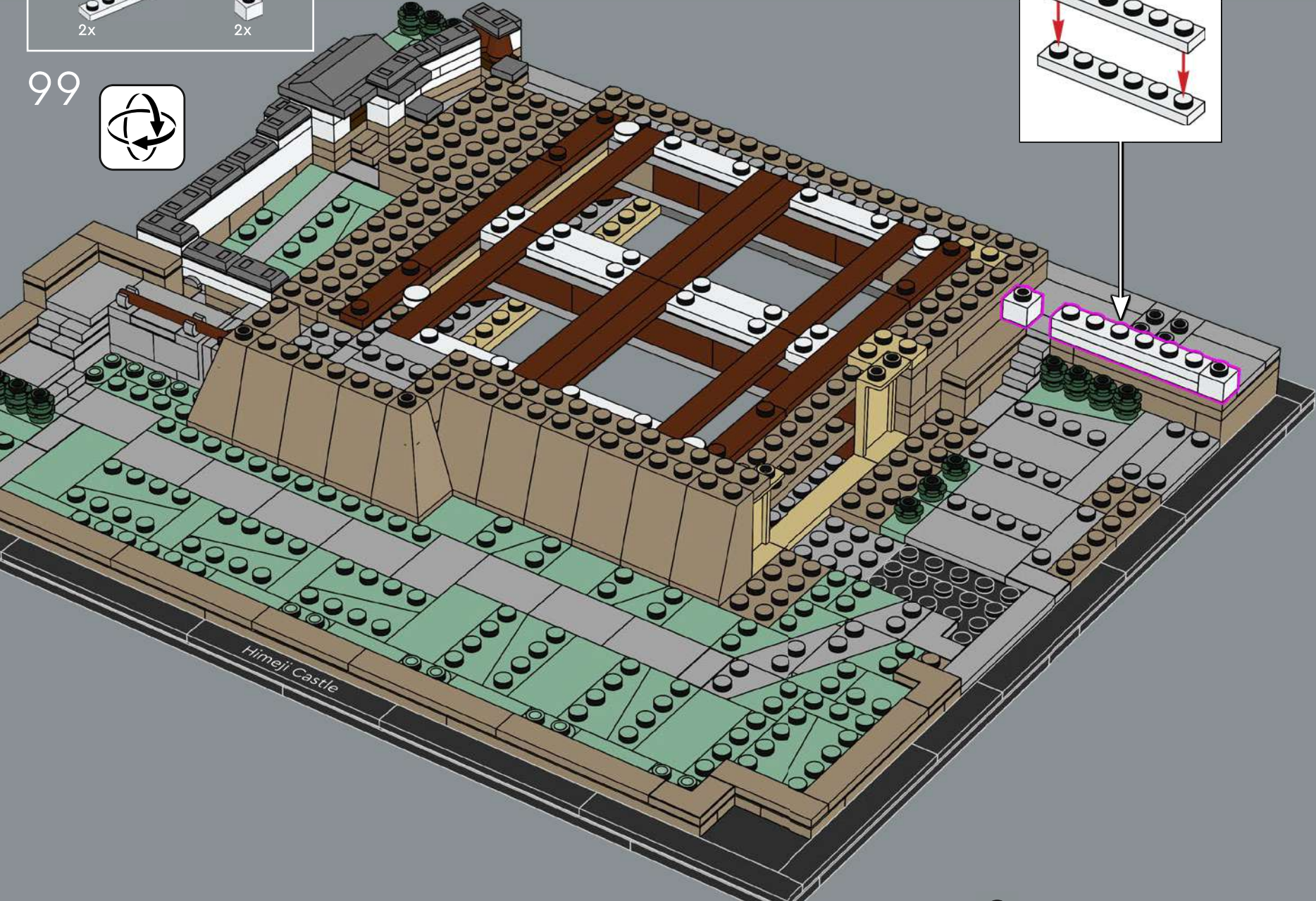
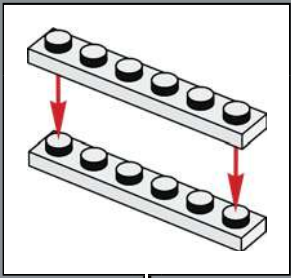

Himeji Castle





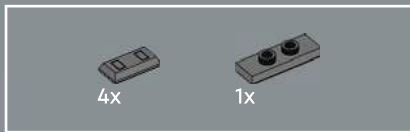

100

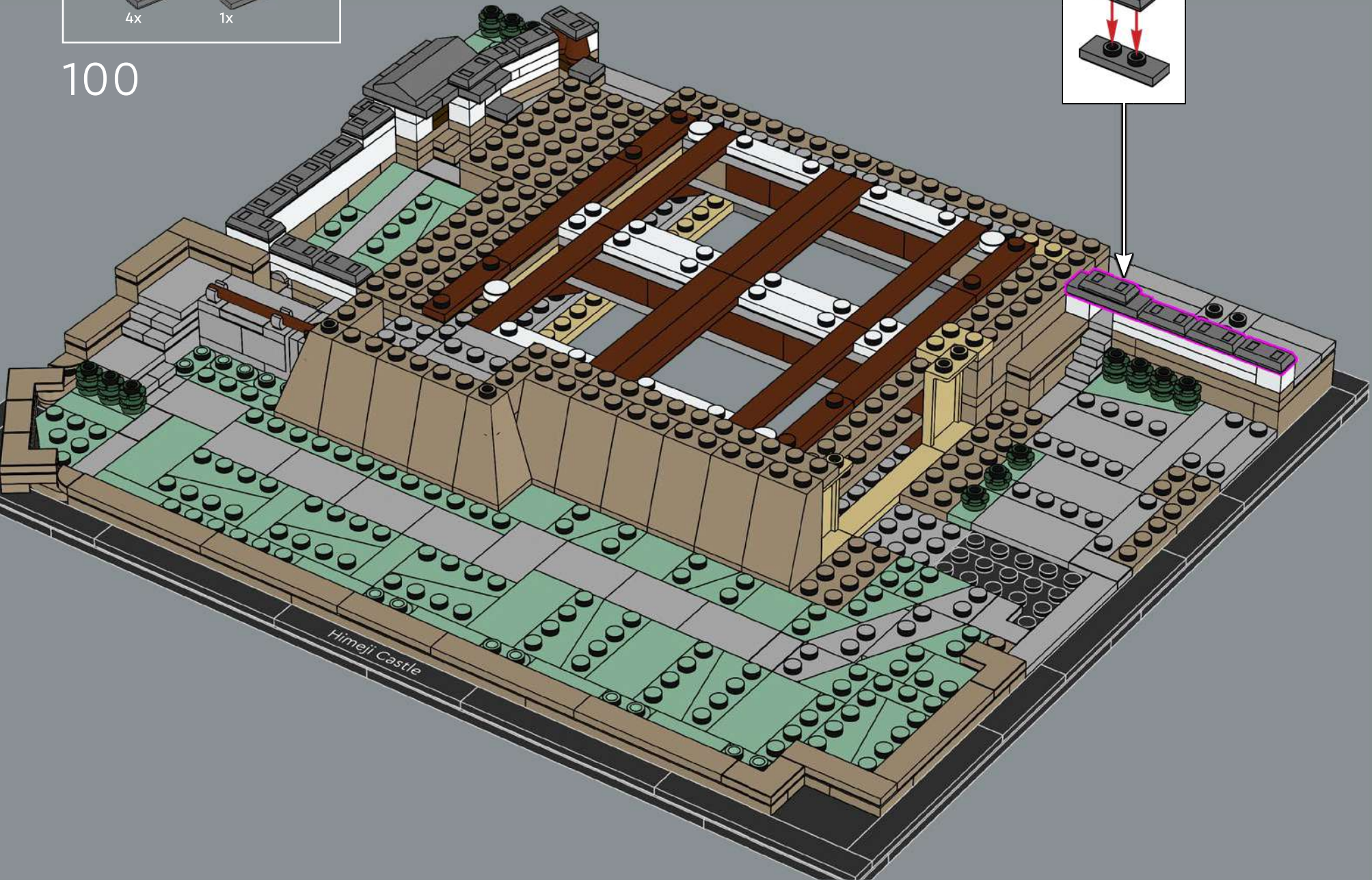
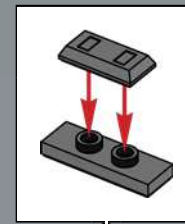

Himeji Castle



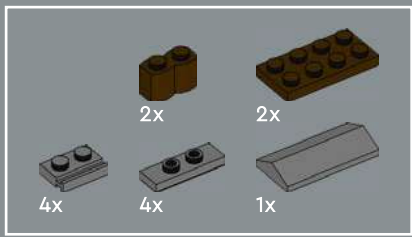

101

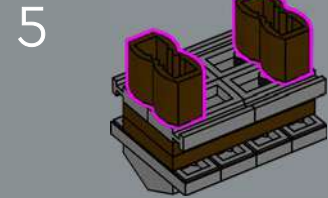
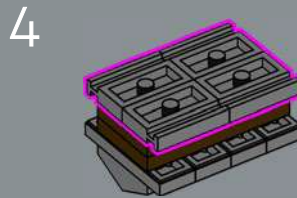
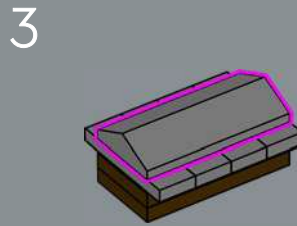
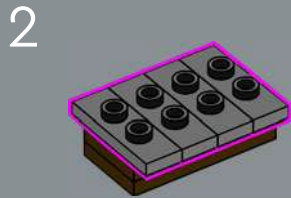
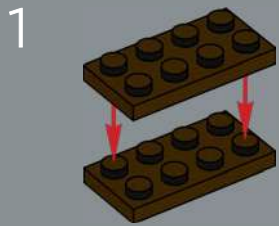

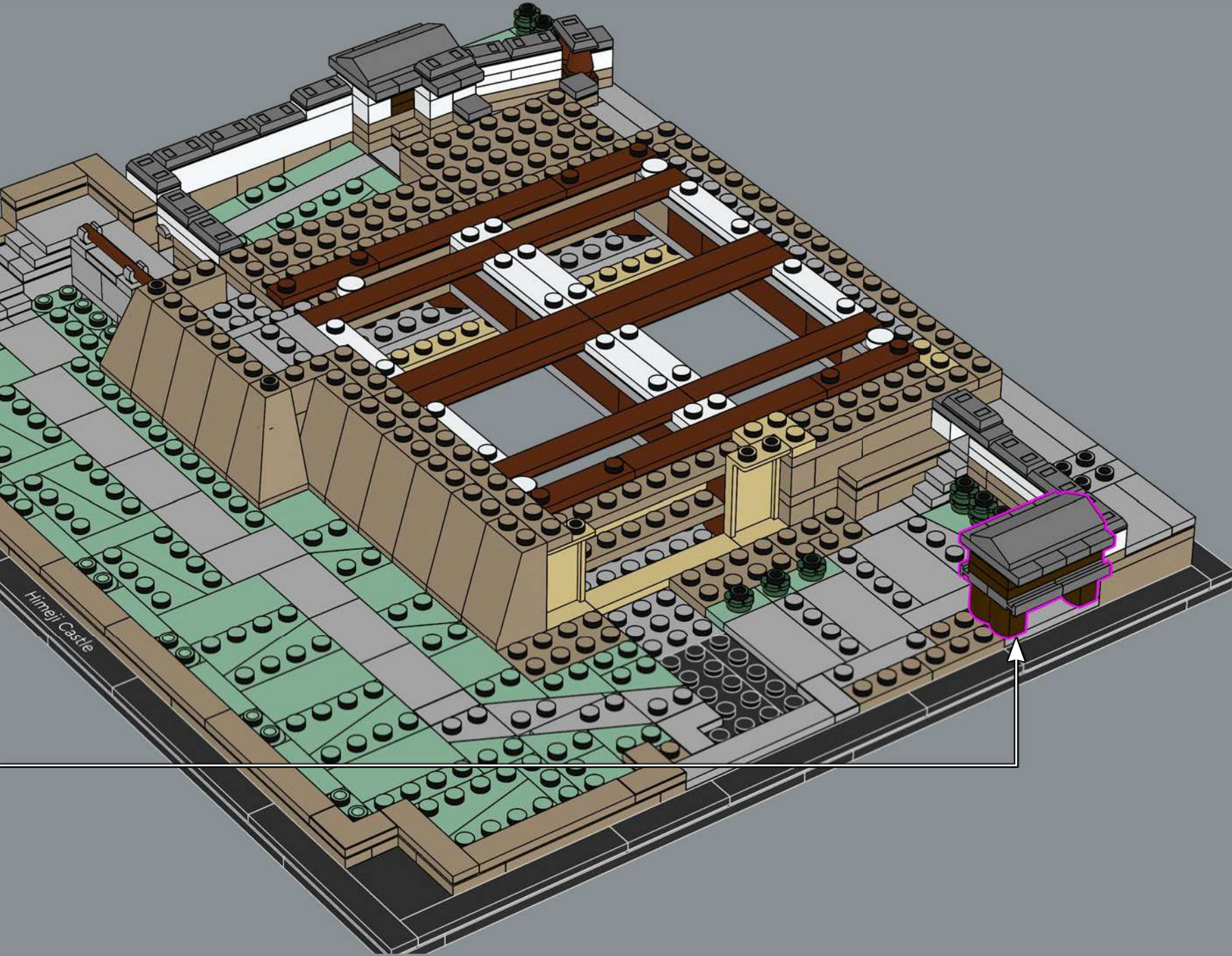

Himeji Castle



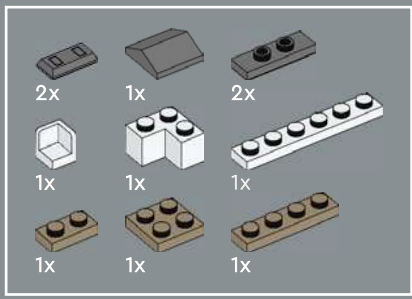

102

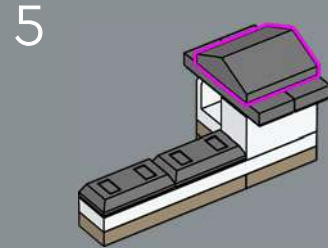
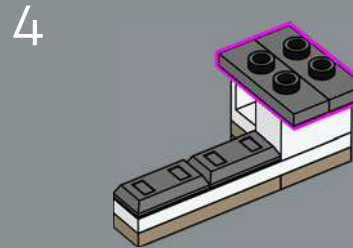
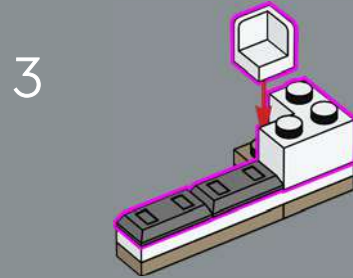
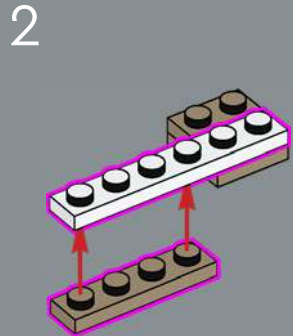
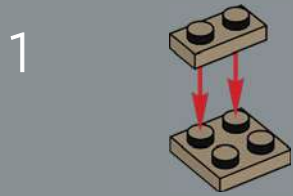

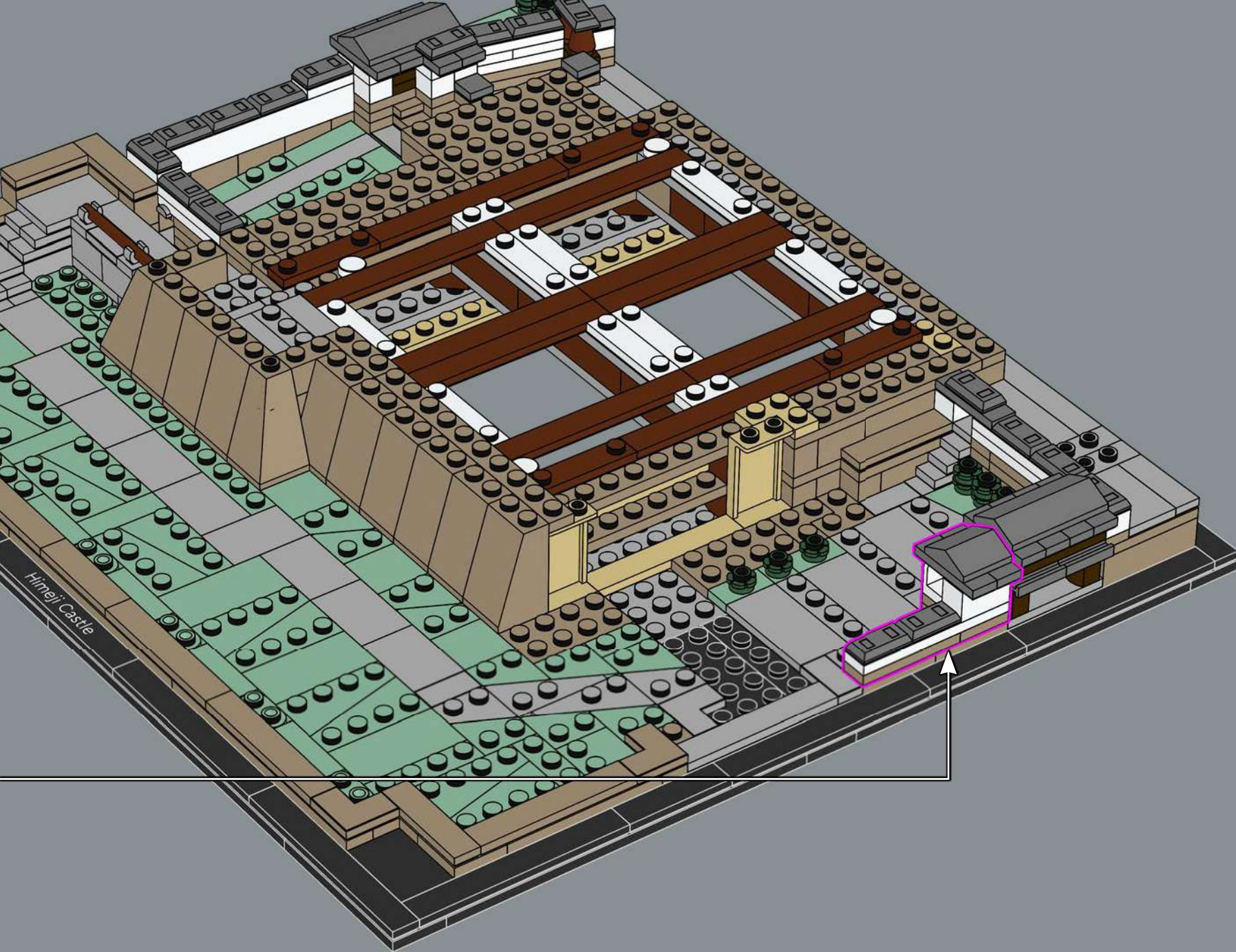



1x 2x 1x

103

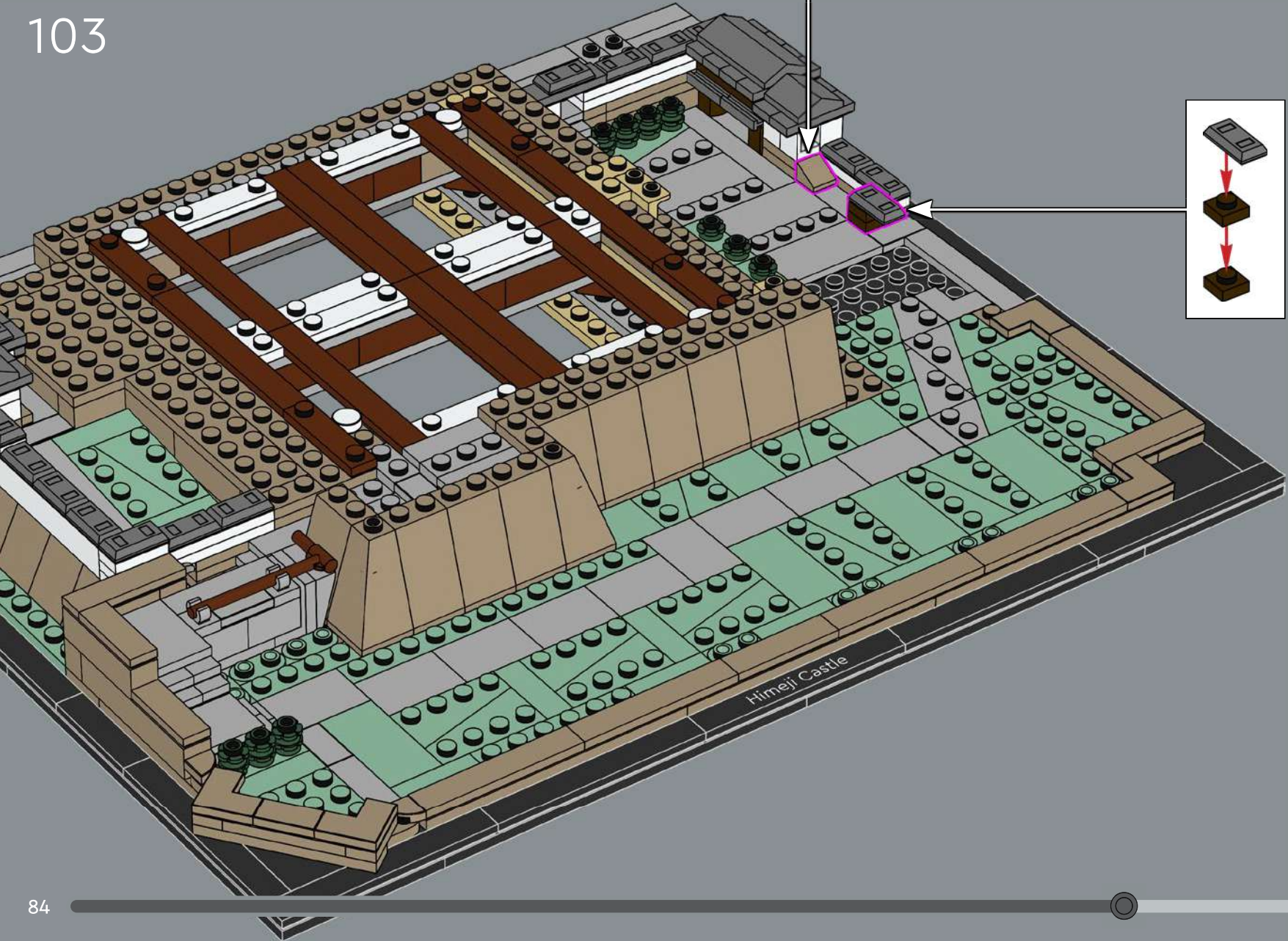
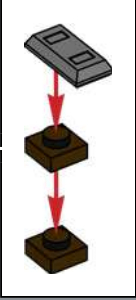



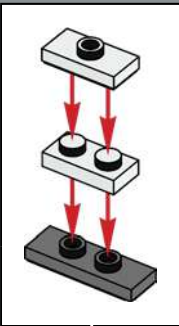
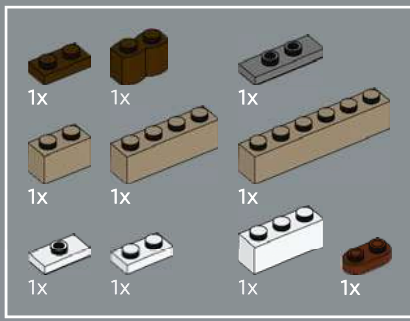

104

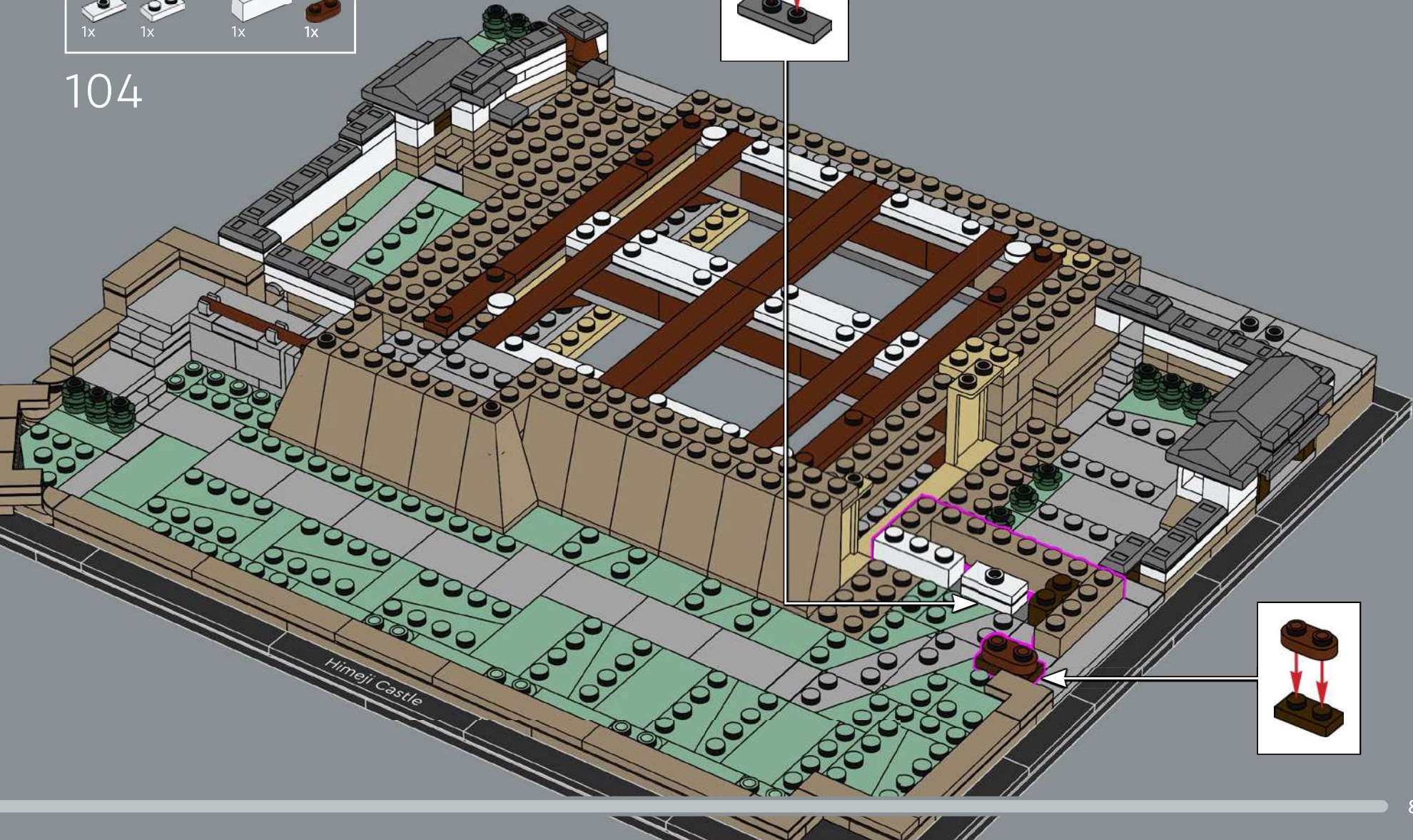



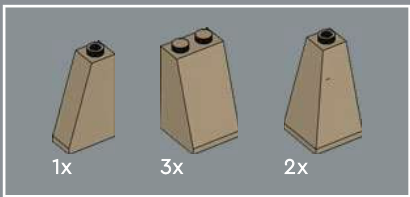

105

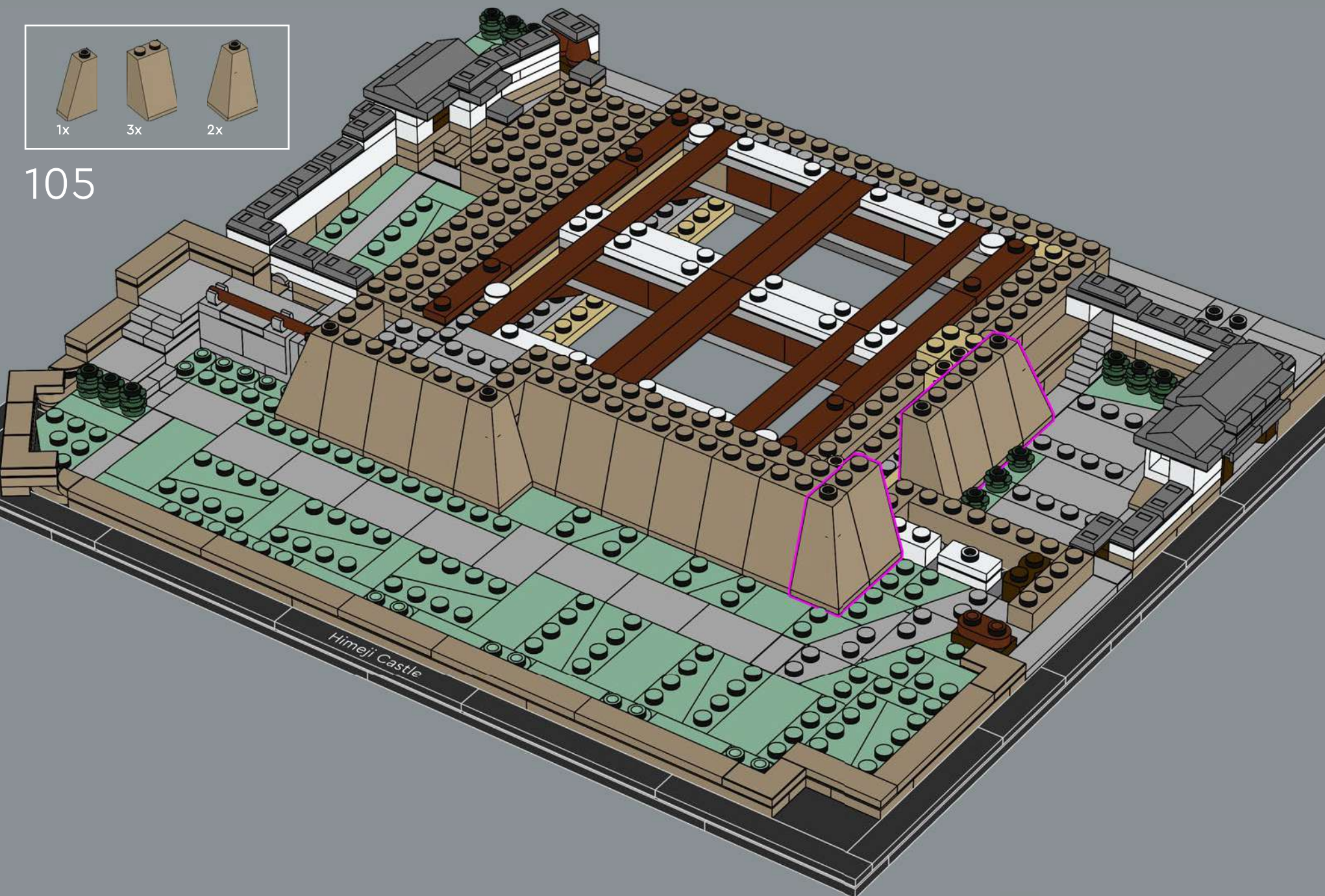

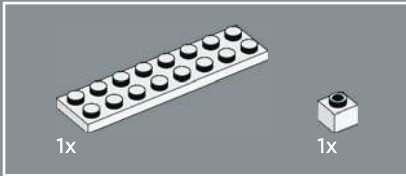
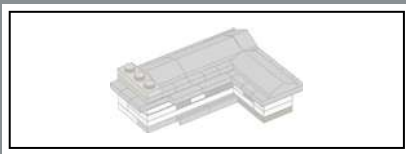

106

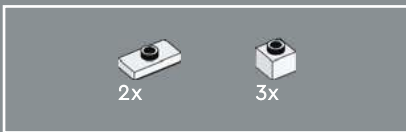
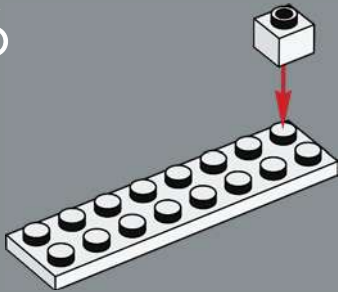

107

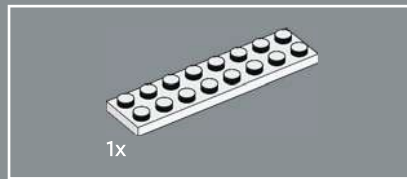
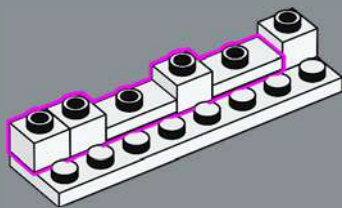

108

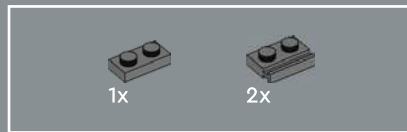
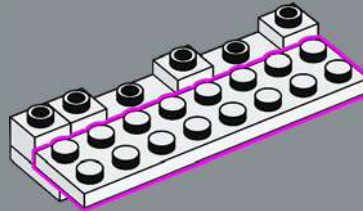

109

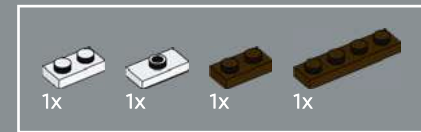
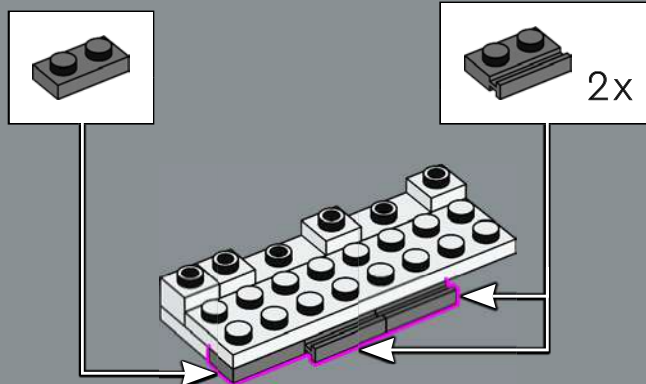

110

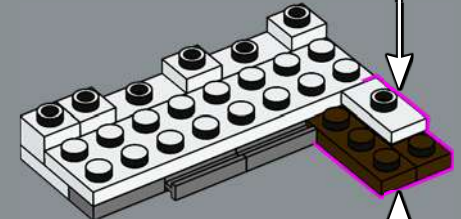
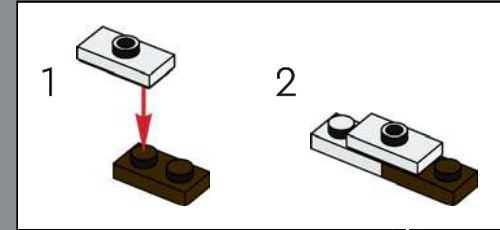

111

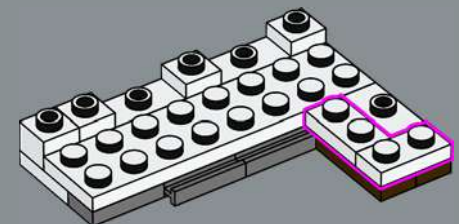



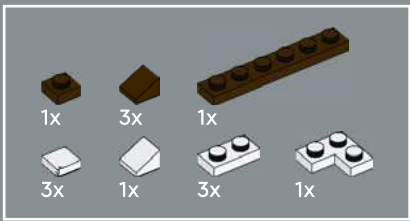

112

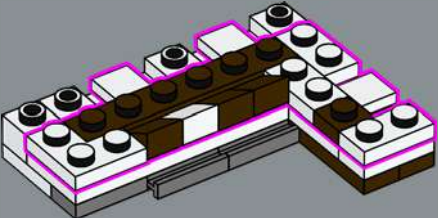

113

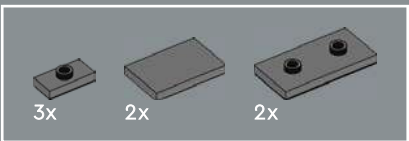
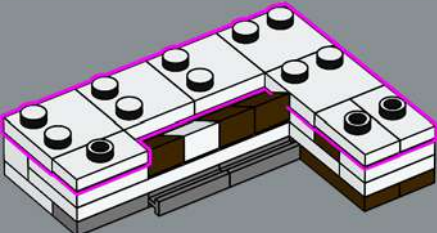

114

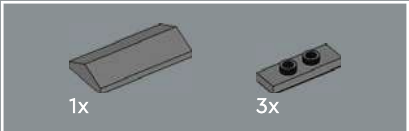
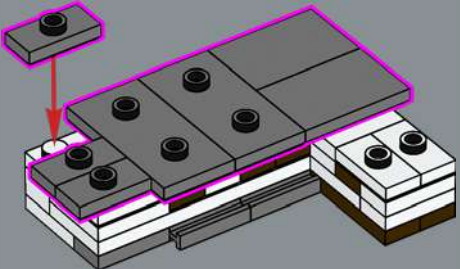

115

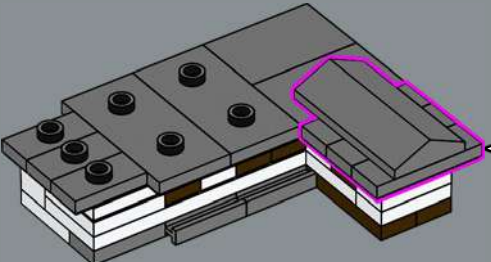
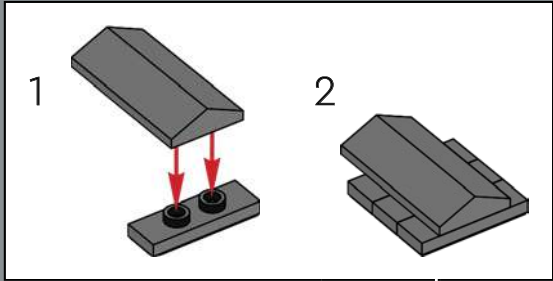



116

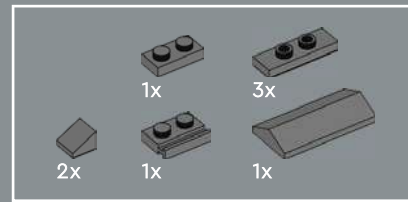
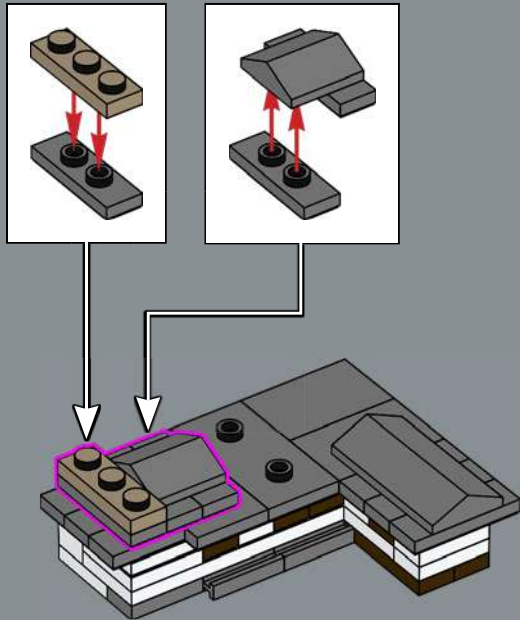

117

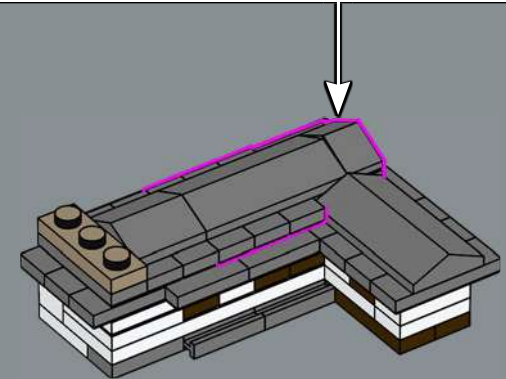
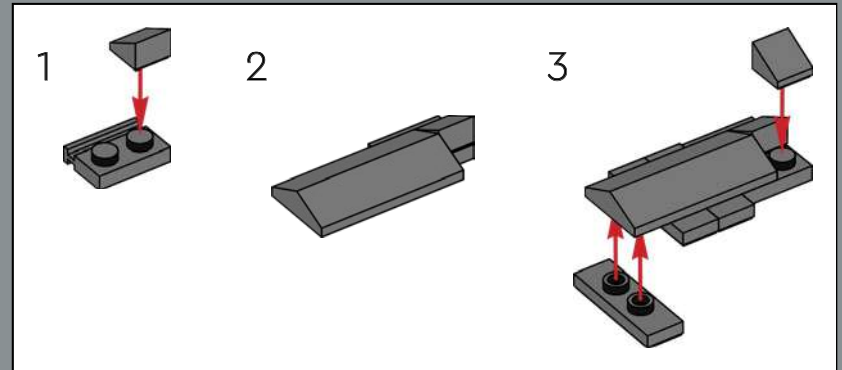



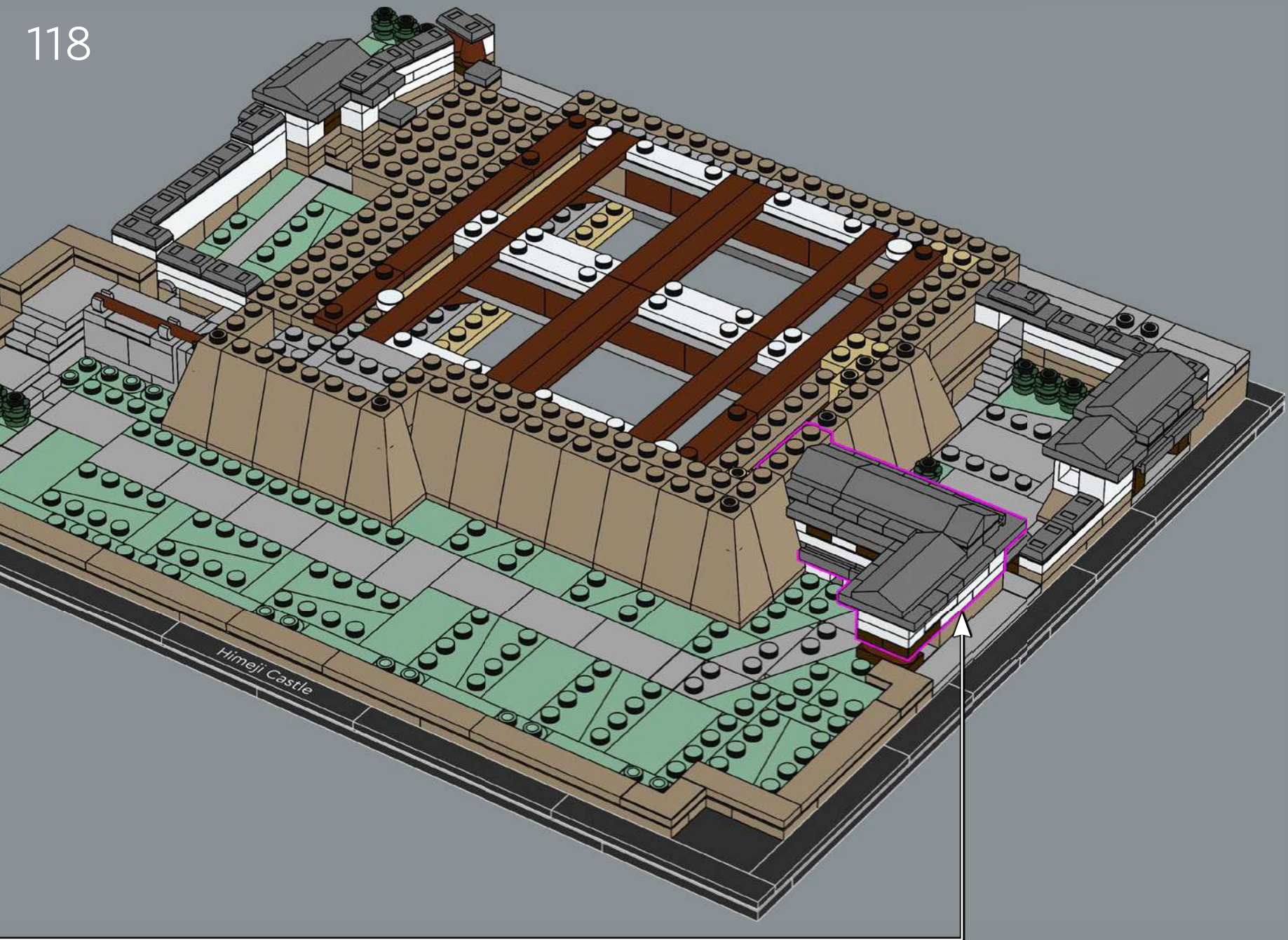



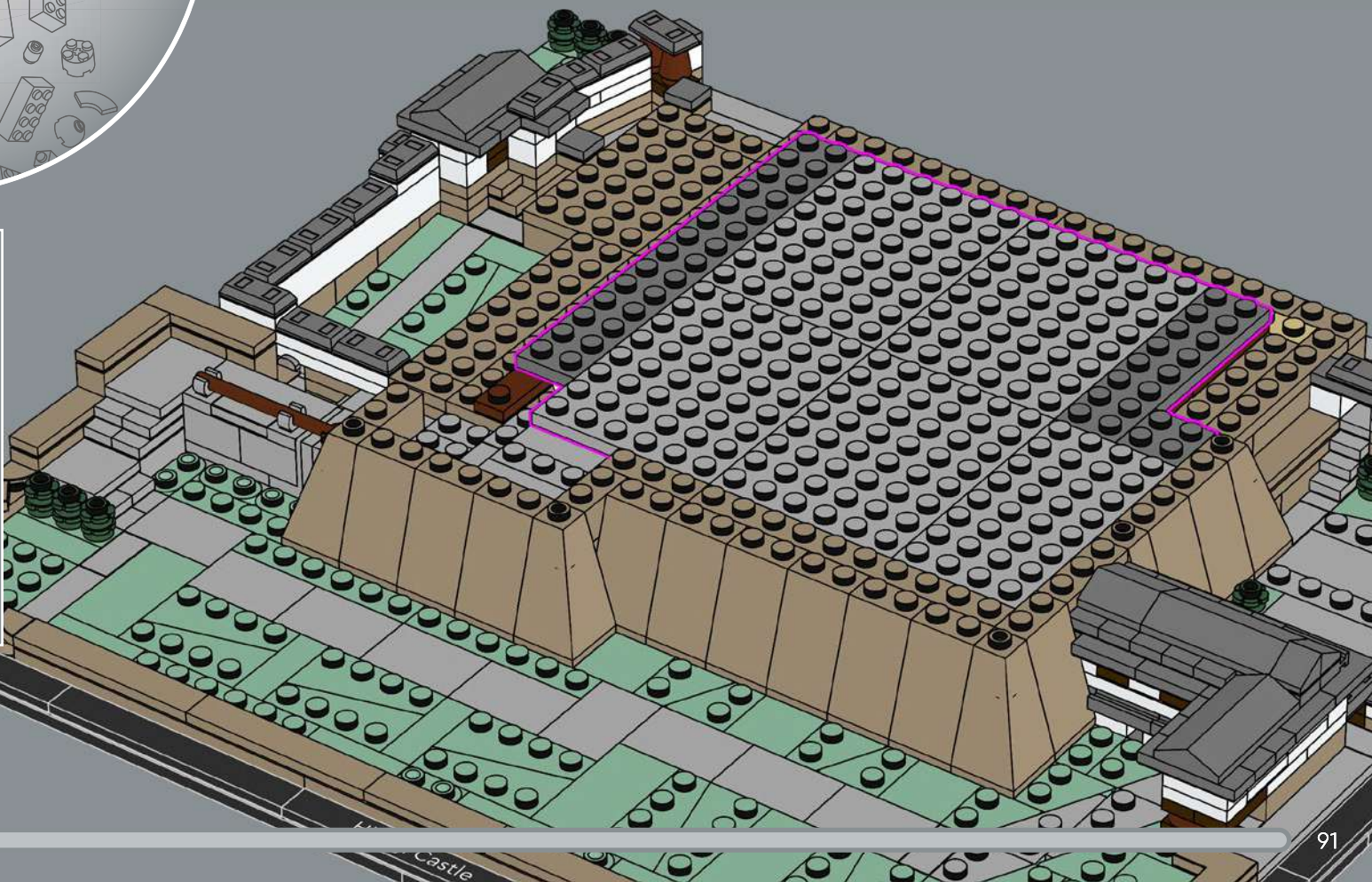
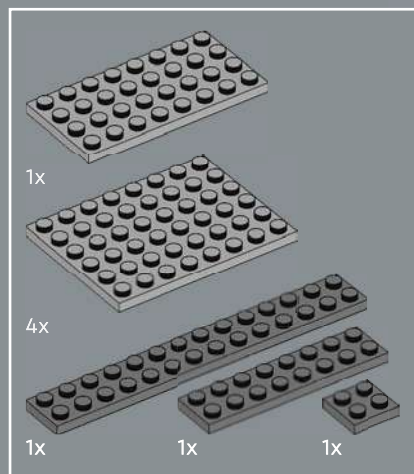

119



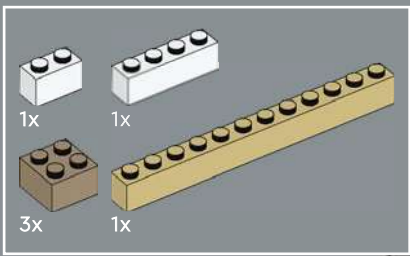

120

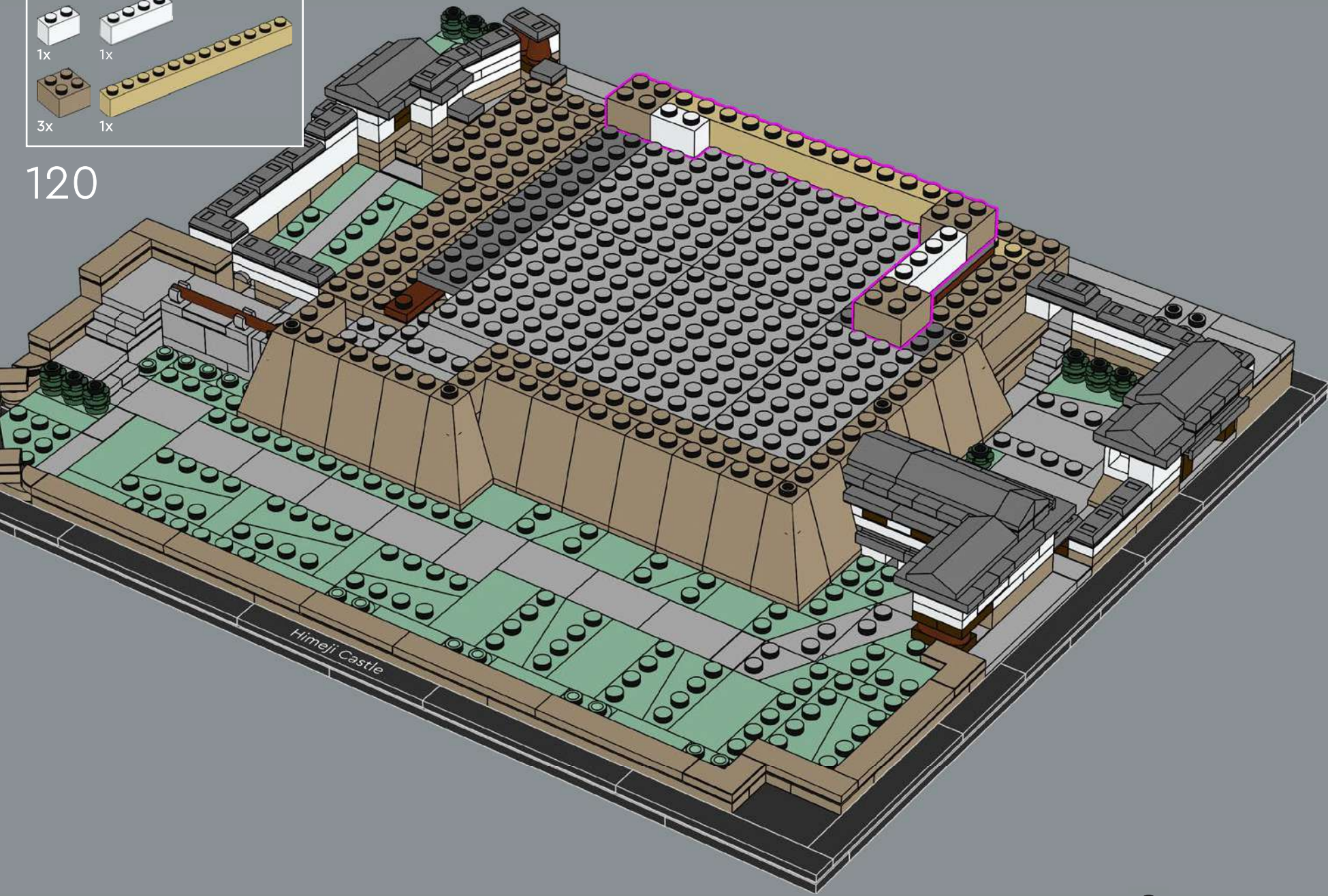



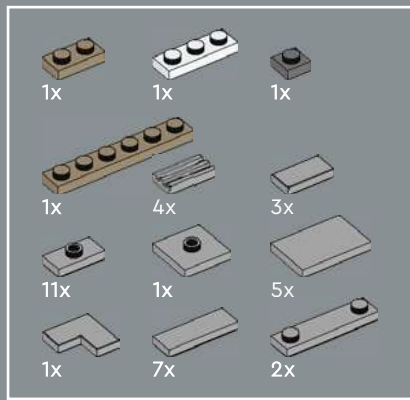

121

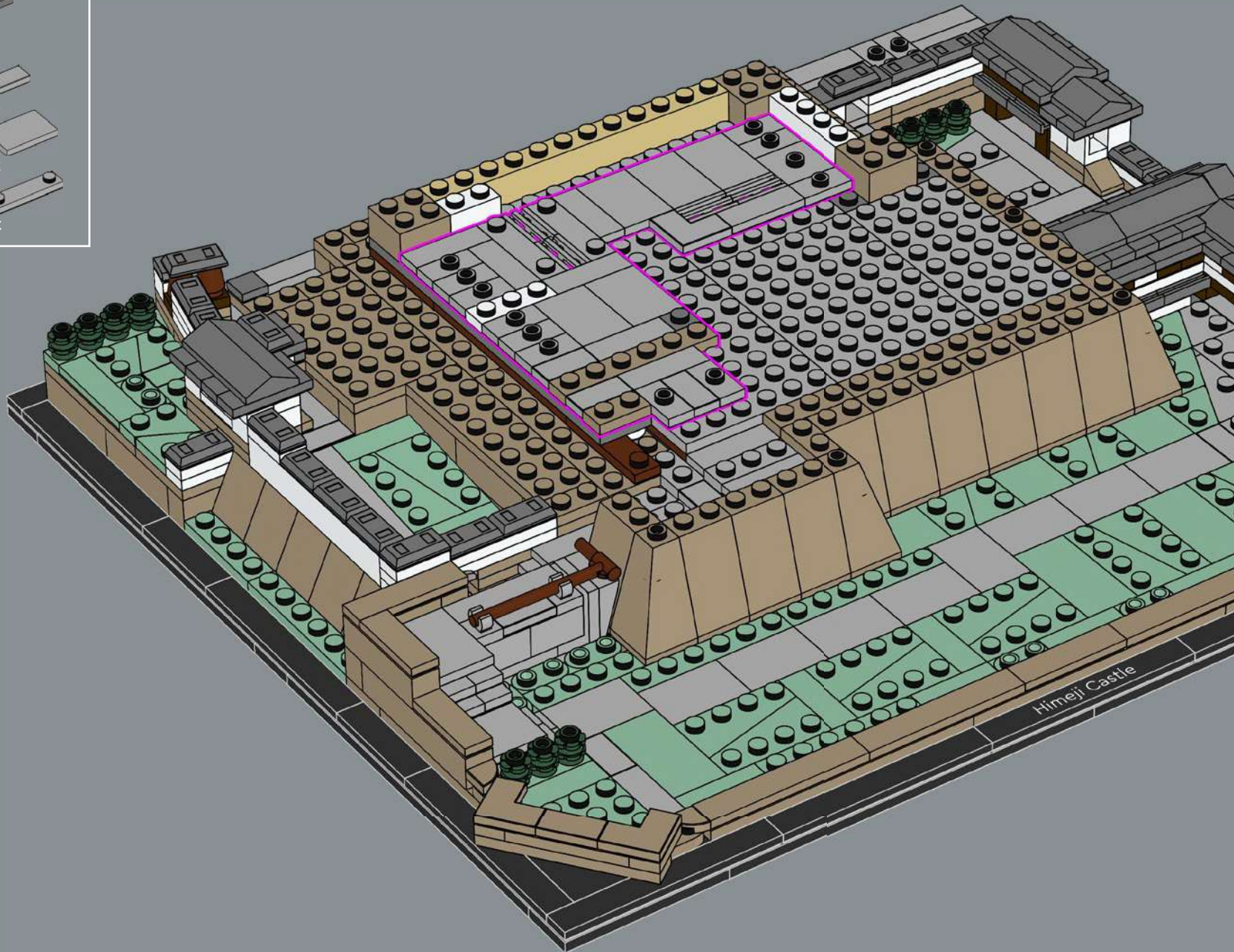



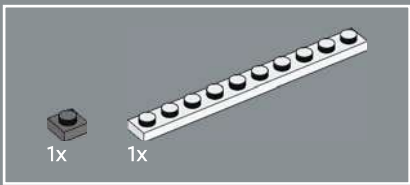

122

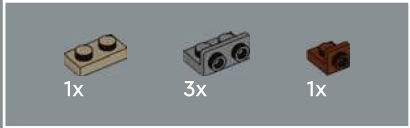
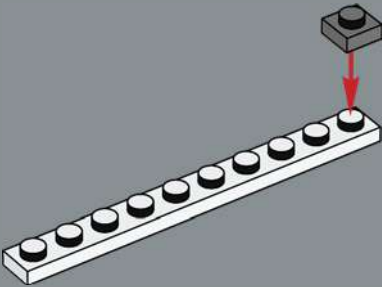

123

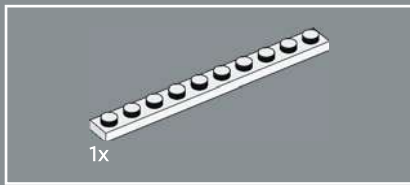
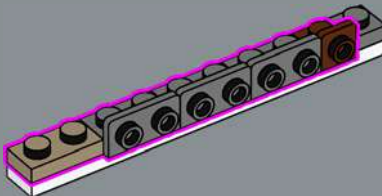

124

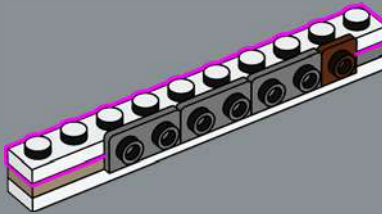

125

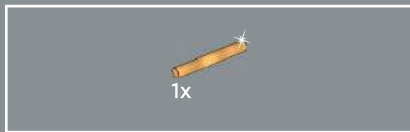
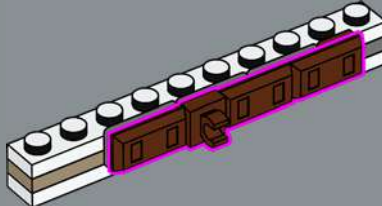

126

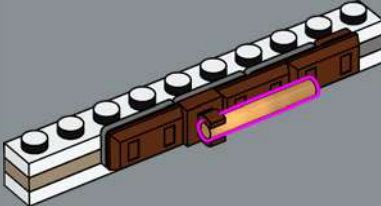

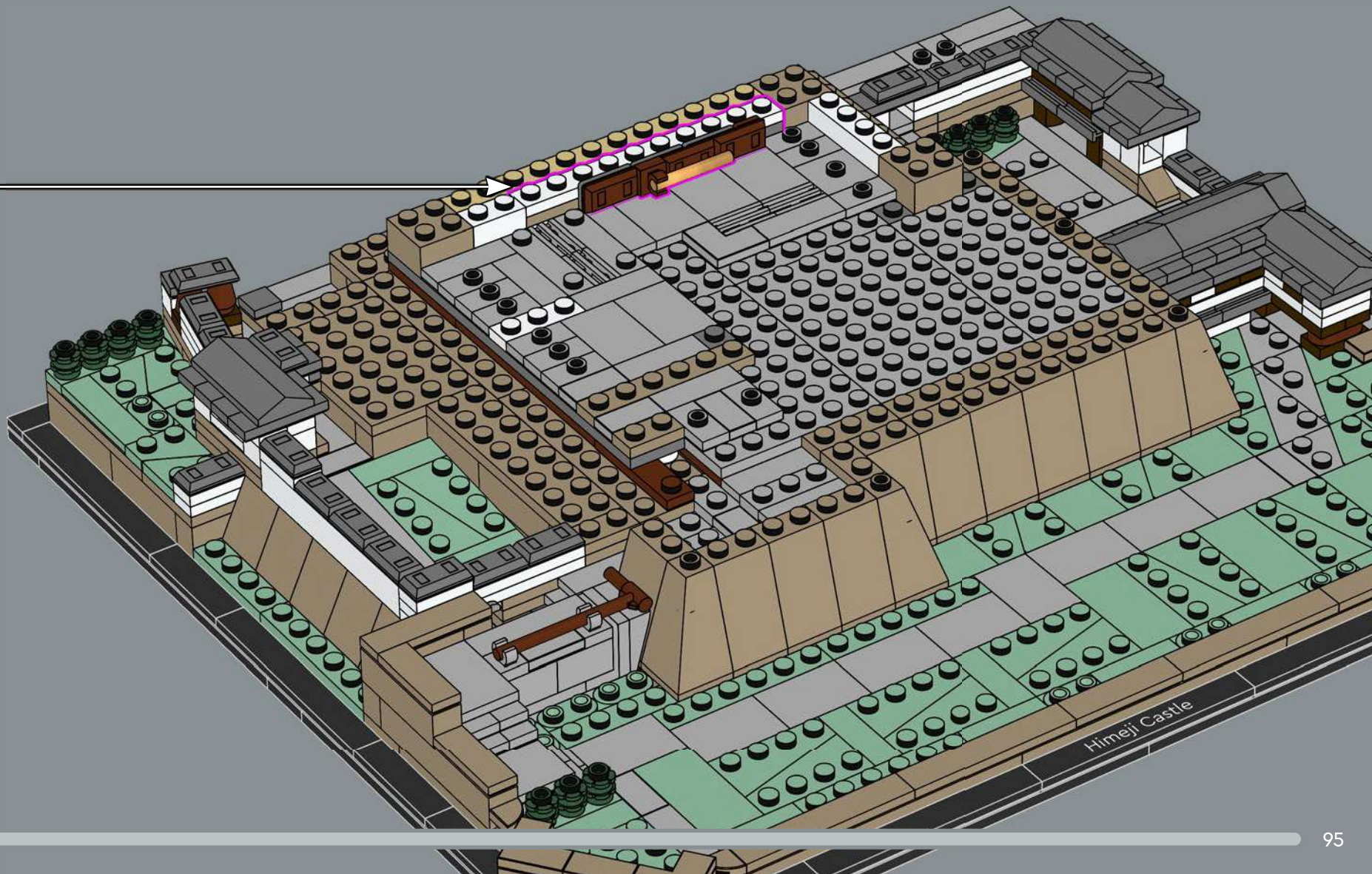

Himeji Castle



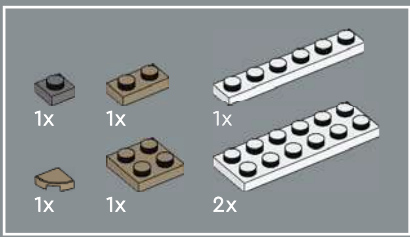

128

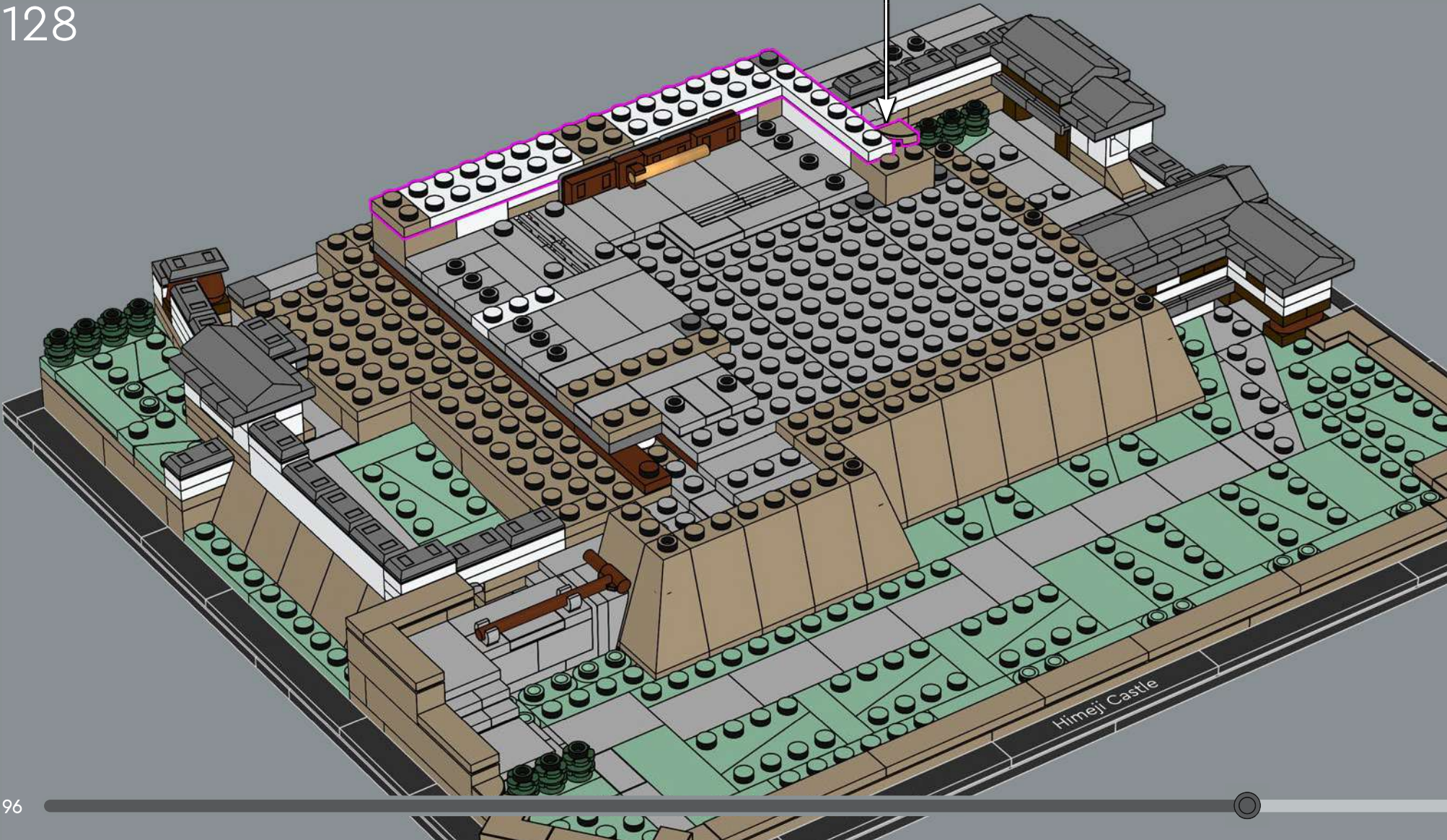



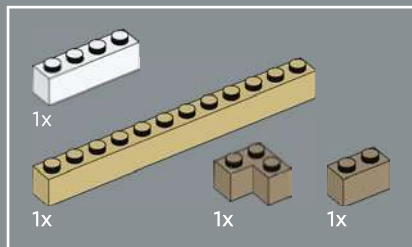

129





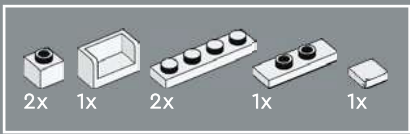

130

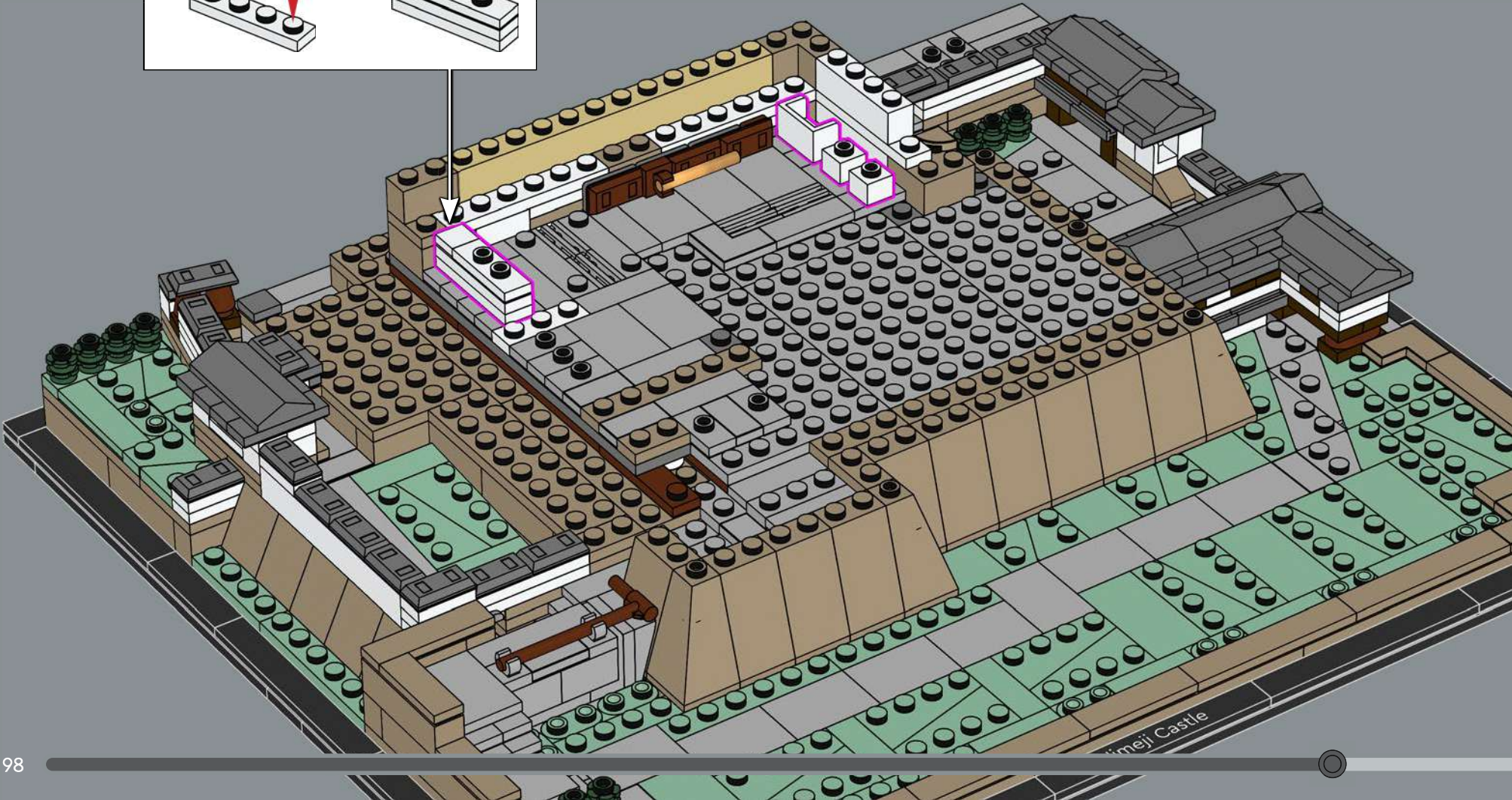
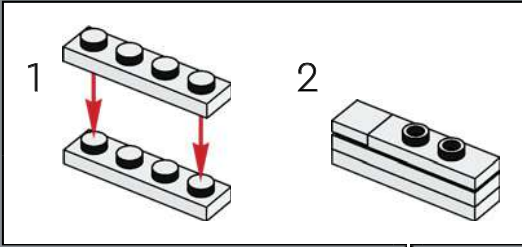



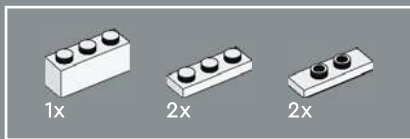

131

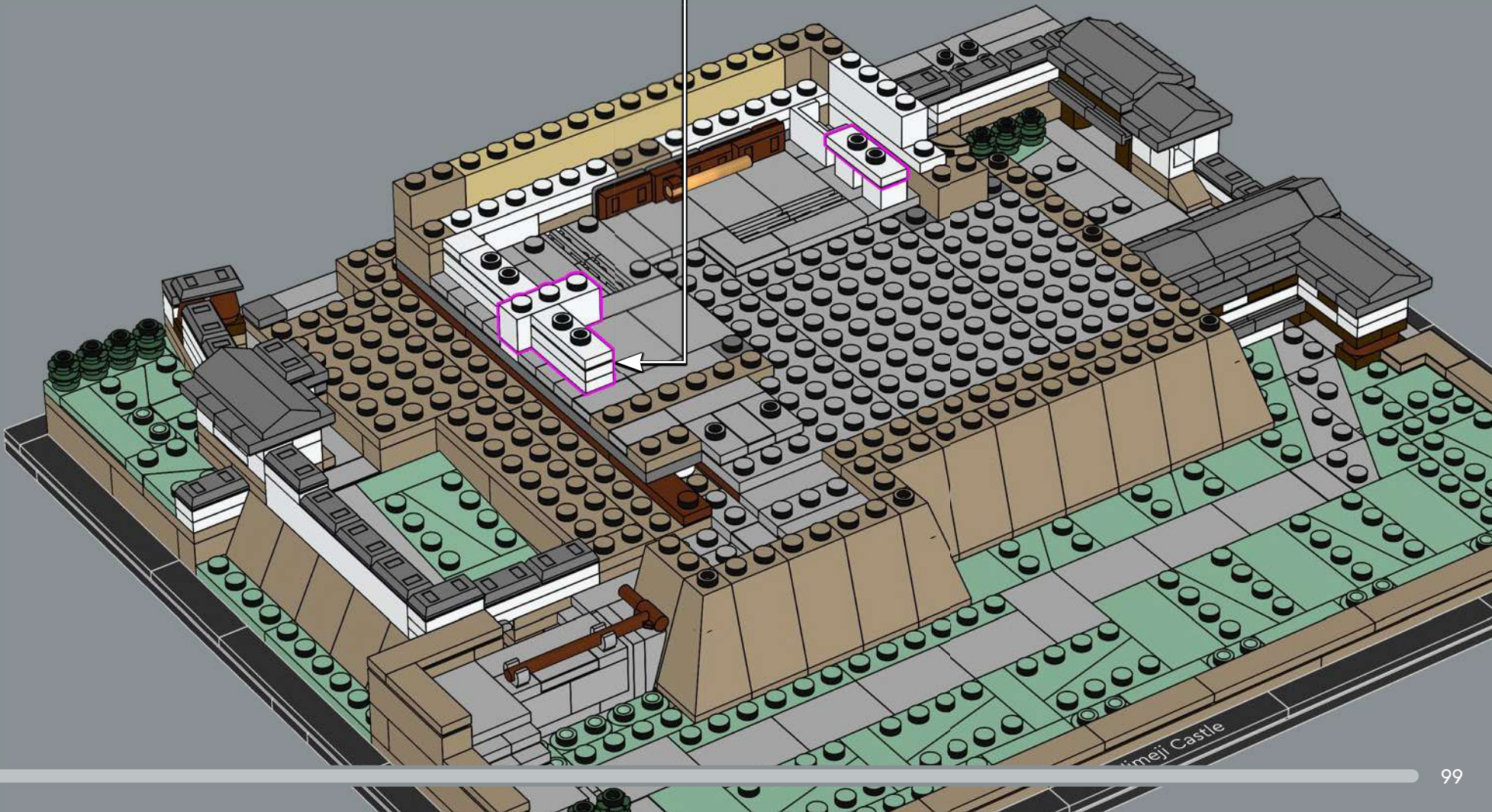
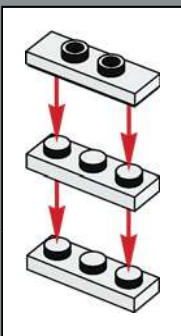



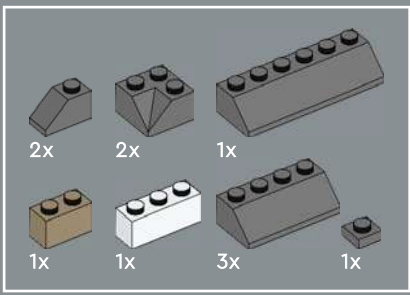

132





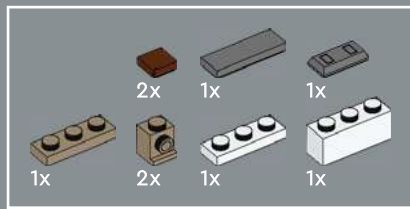

133

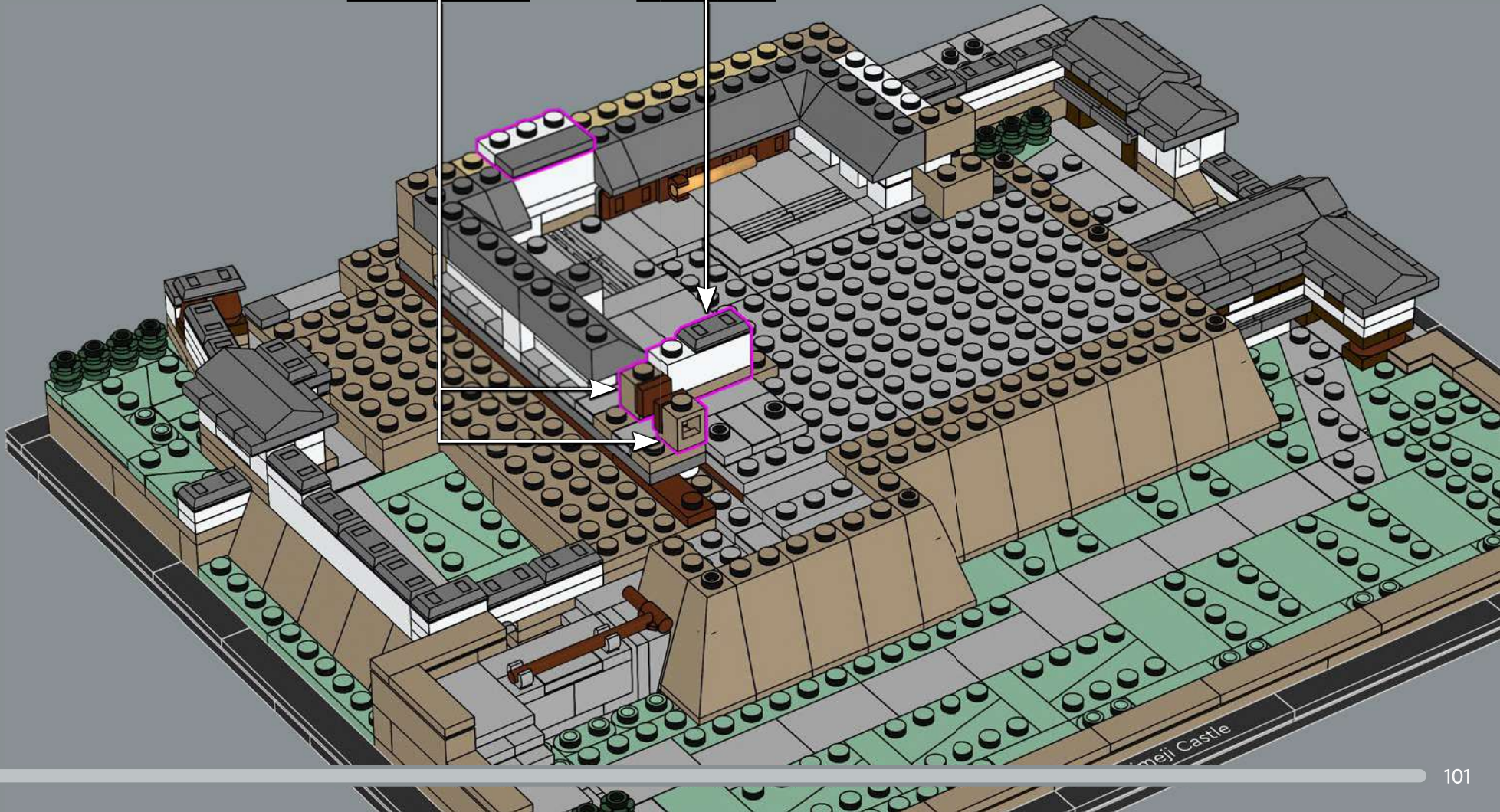
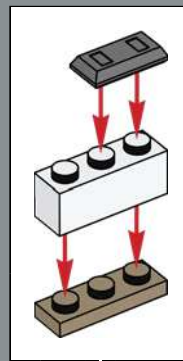
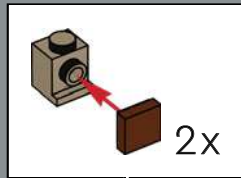

Meiji Castle



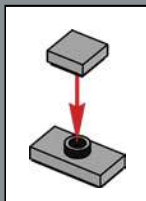
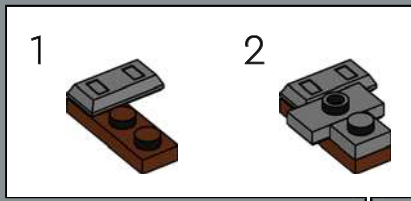

134

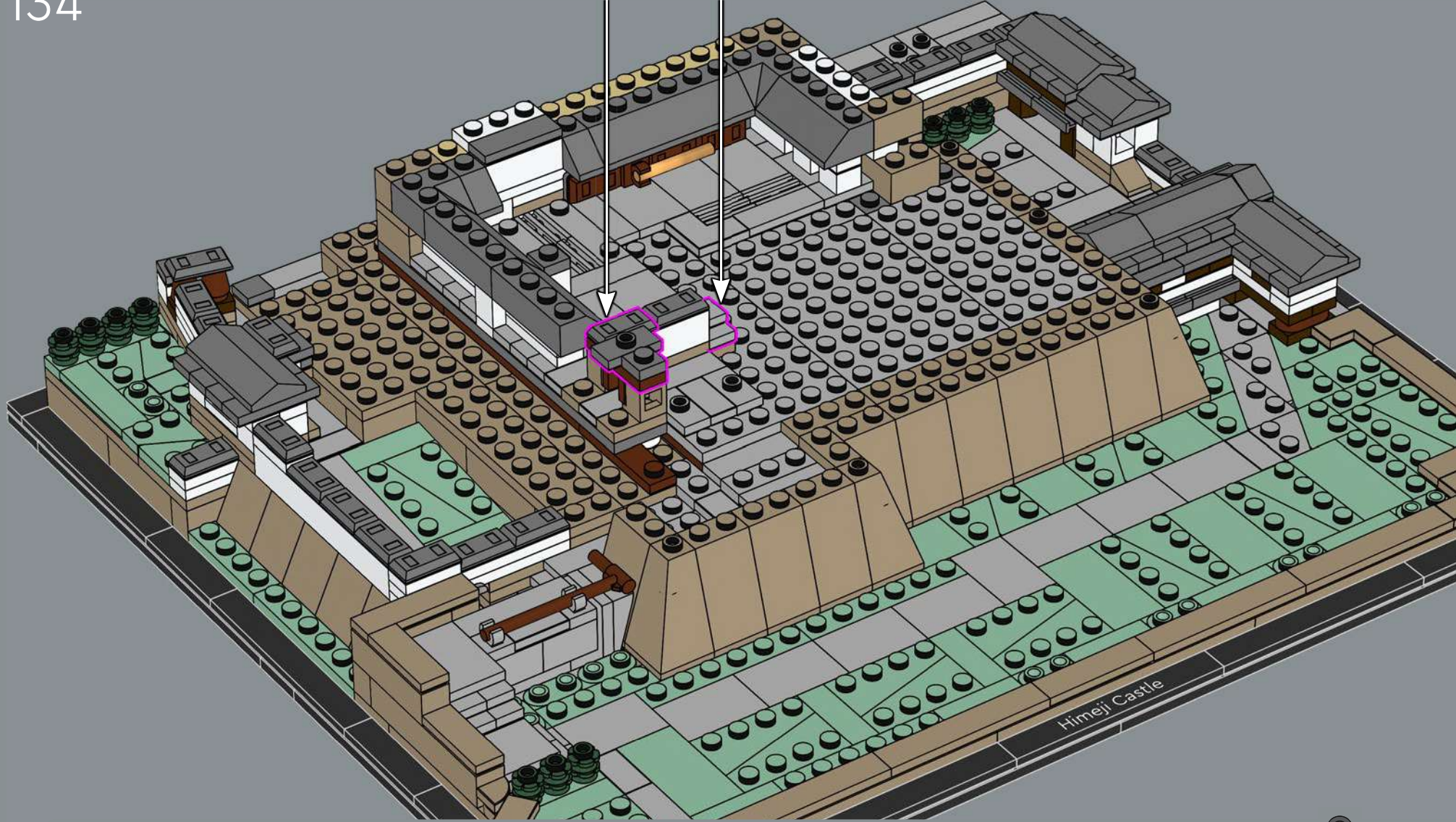

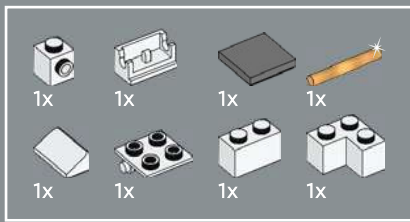

135

