



CITY

60366



1



LEGO.com/sustainable-packaging

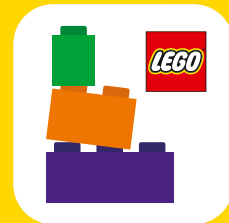

BUILDER



Apple and the Apple logo are trademarks of Apple Inc., registered in the U.S. and other countries and regions. App Store is a service mark of Apple Inc. Google Play and the Google Play logo are trademarks of Google LLC. Tencent and the Tencent logo are trademarks of Tencent Inc.

Q LEGO.com/devicecheck

EN Ask parents' permission before going online | DE Eltern um Erlaubnis bitten, bevor du online gehst | FR Demande l'autorisation d'un parent avant d'aller en ligne | IT Chiedi il permesso ai tuoi genitori prima di andare online | ES Pídeles permiso a tus papás antes de conectarte a Internet | PT Pede autorização aos pais antes de acederes online | ZH 上网前应先征得父母的同意 | PL Poproś rodziców o zgodę, zanim wejdziesz do Internetu | CS Než půjdeš na internet, požádej rodiče o svolení | SK Skôr než půjdeš na internet, vypýtaj si povolenie od rodičov | HU Kérj szülői engedélyt, mielőtt online csatlakoznál! | RO Cere permisiunea părinților înainte de a te conecta online | BG Поискайте разрешение от родител, преди да влезете онлайн | LV Pirms došanās tiešsaistē palūdz atļauju vecākiem | ET Enne Interneti kasutamist küsi vanematelt luba | LT Prieš prisijungdami prie interneto, atsklauskite tėvų

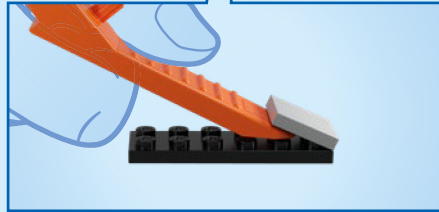
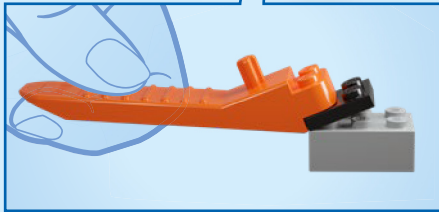
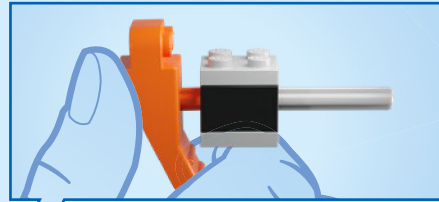
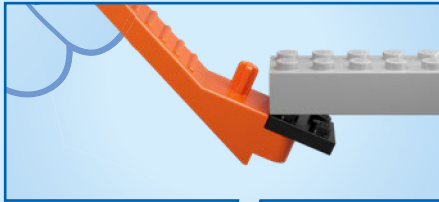

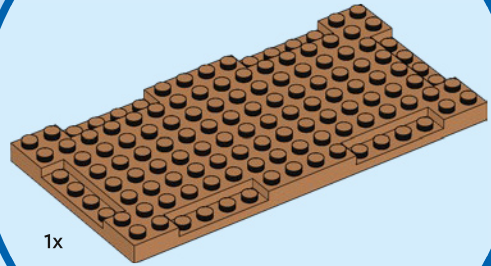
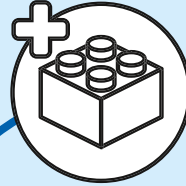
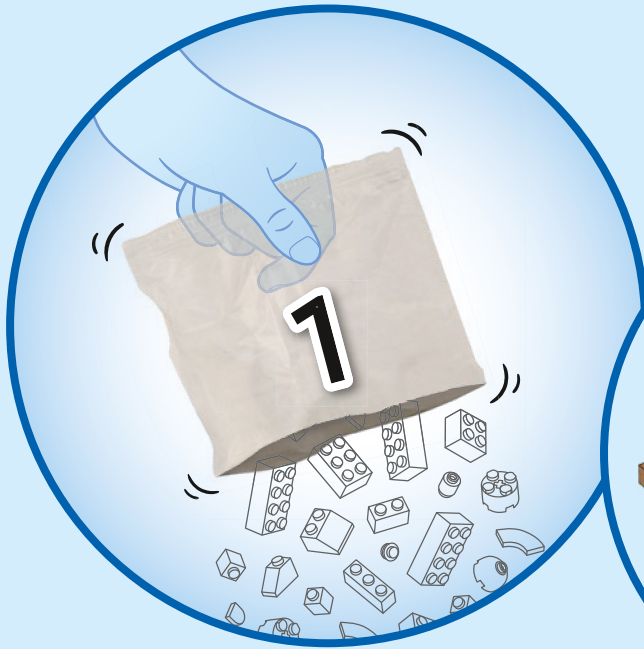

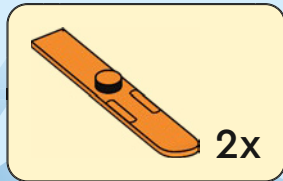
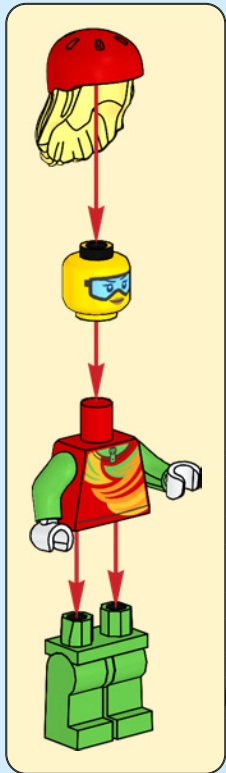

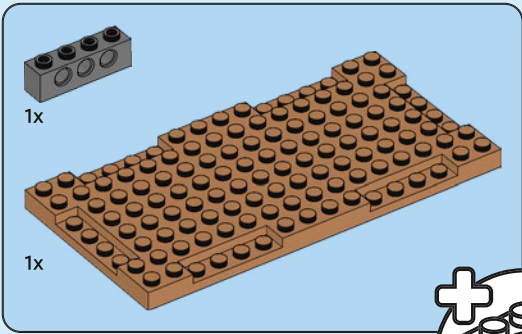

1

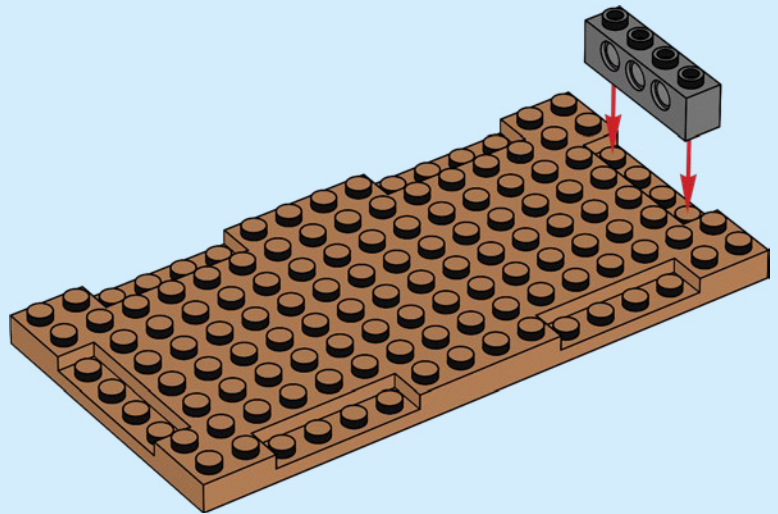
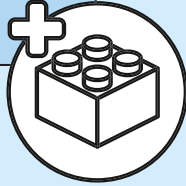



2x

2

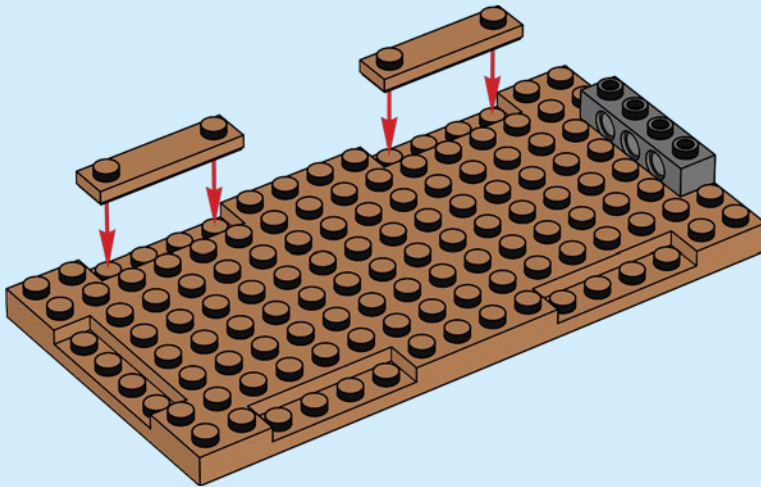

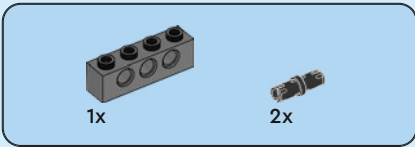

3

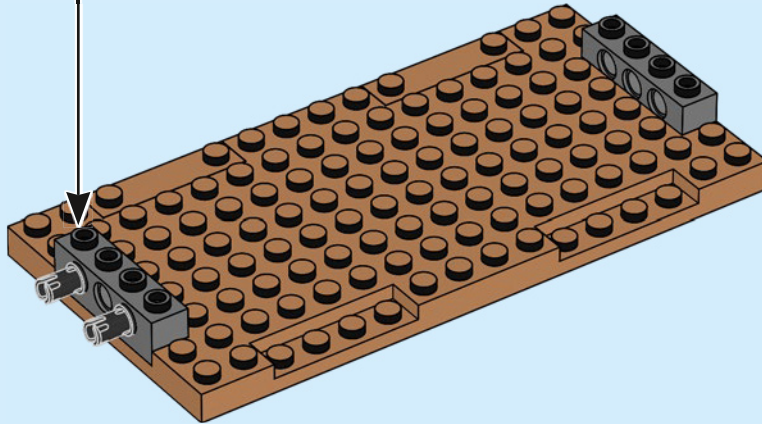
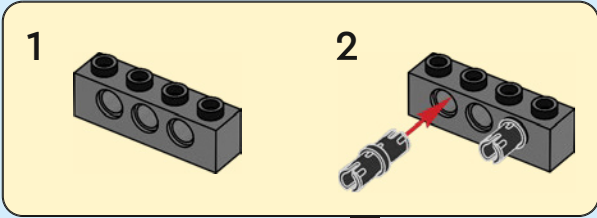

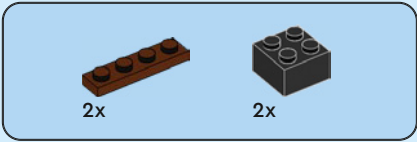

4

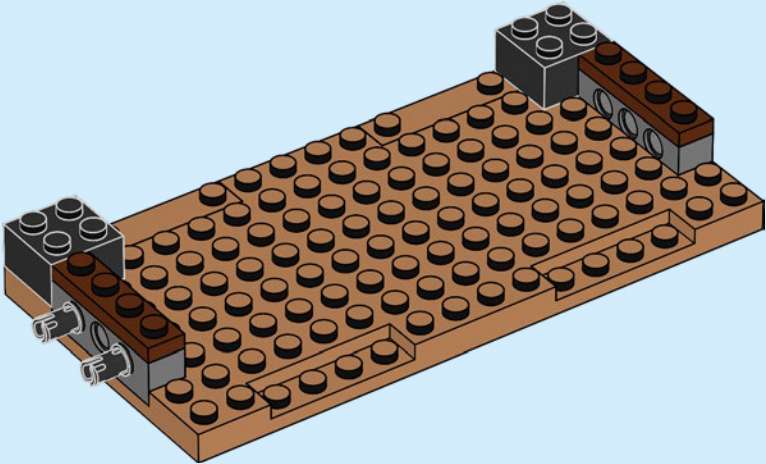



4x

5

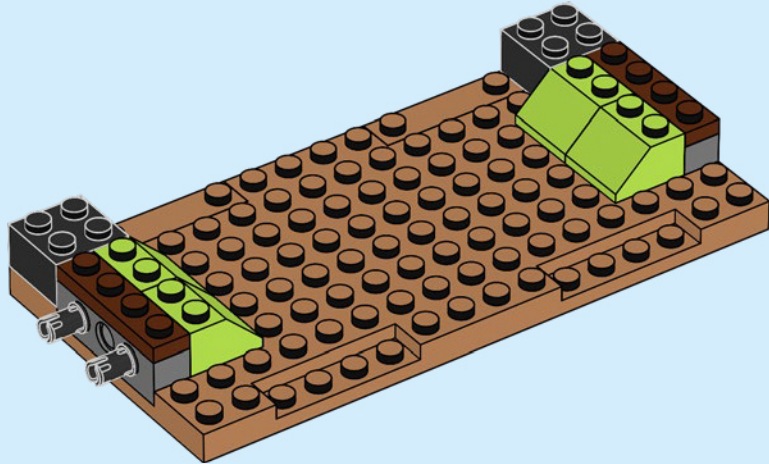



2x

6

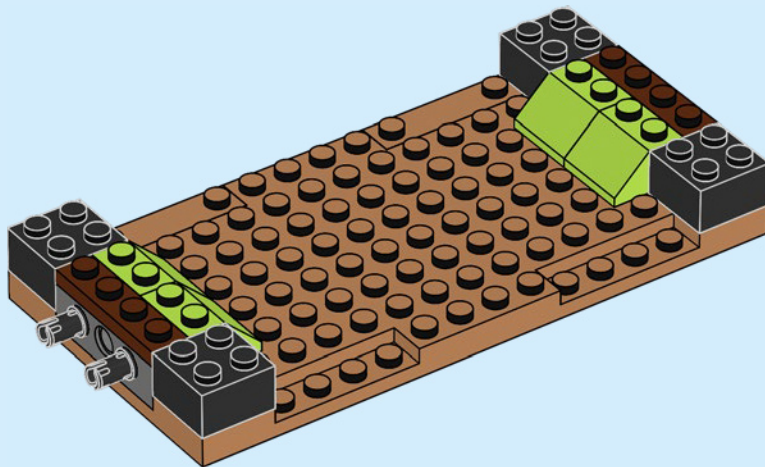

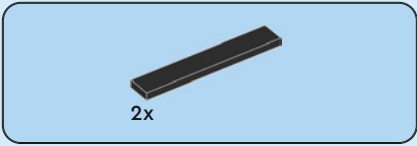

8

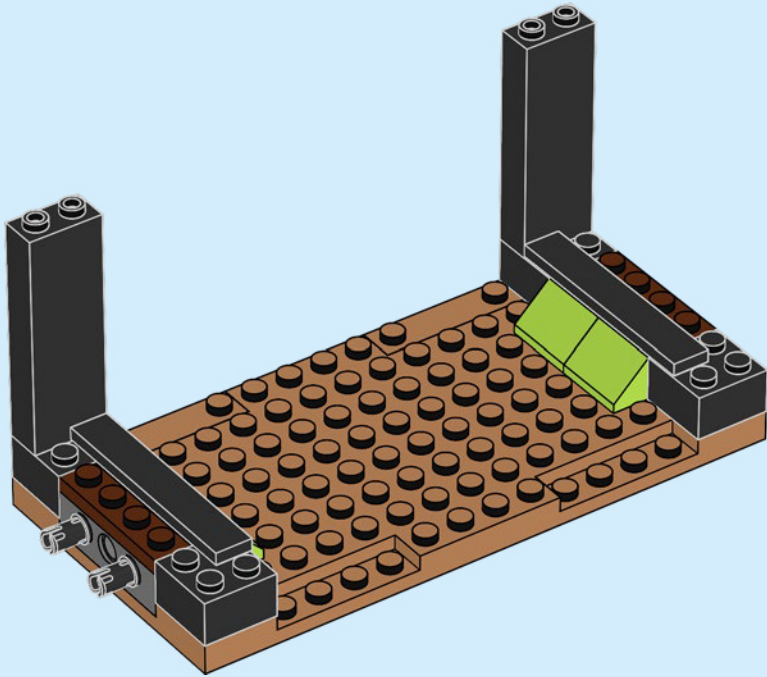

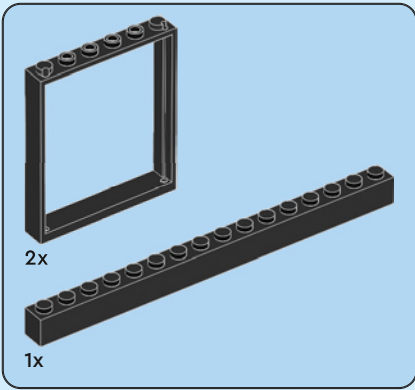

9

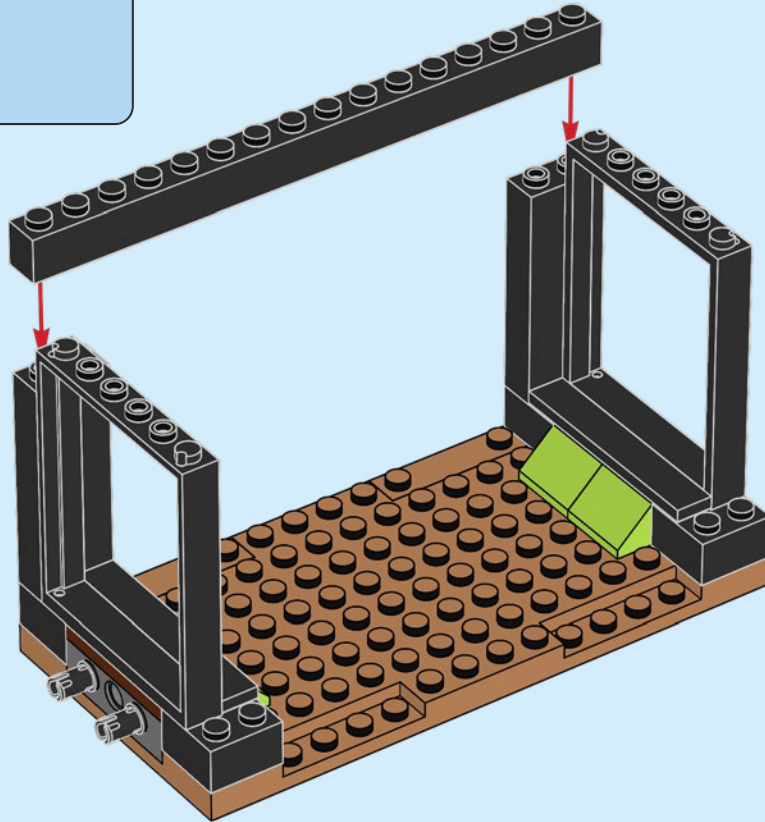



2x

10

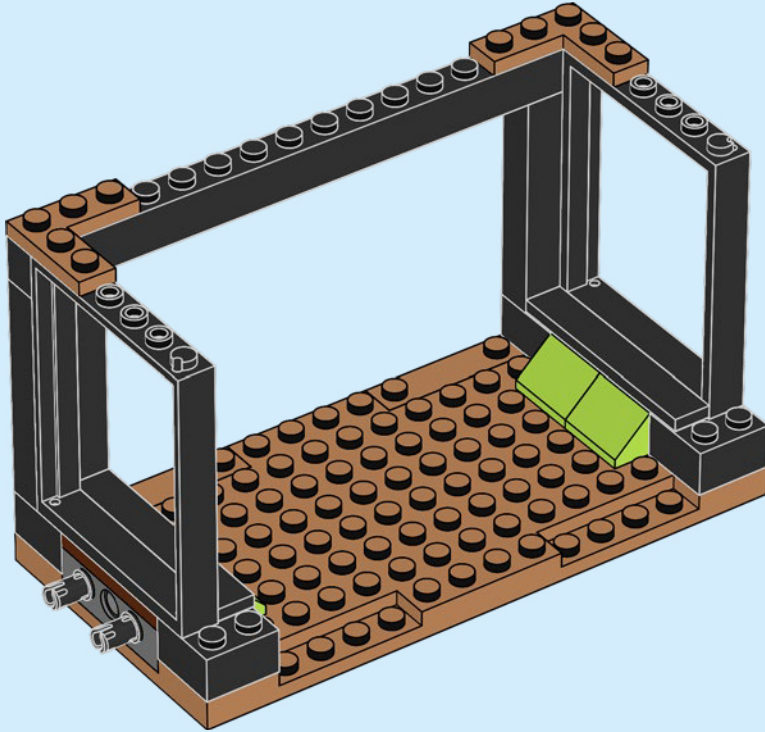

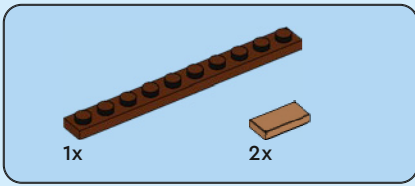

11

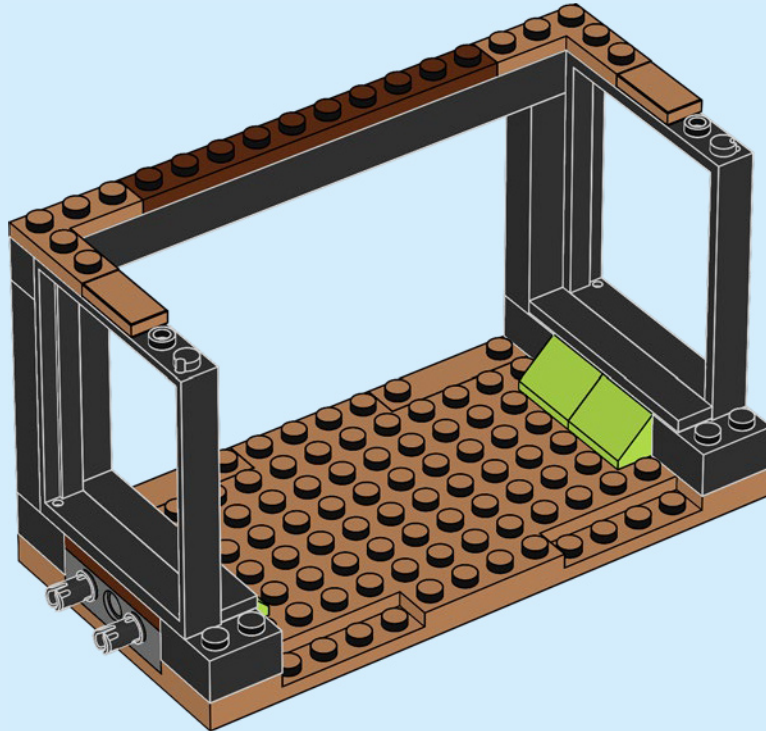

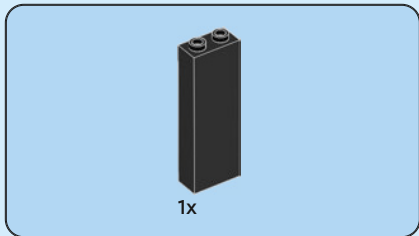

12

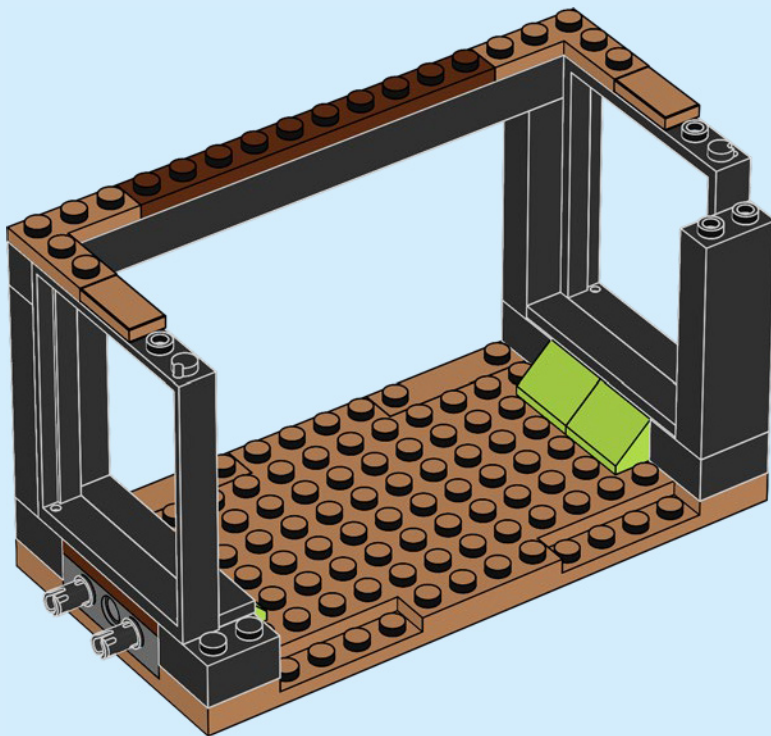

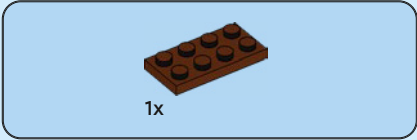
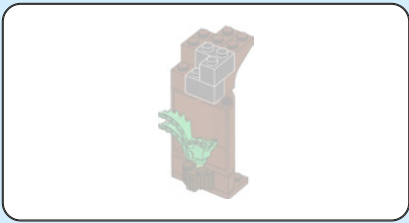

13

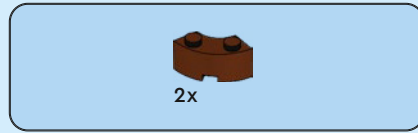
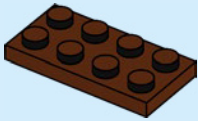

14

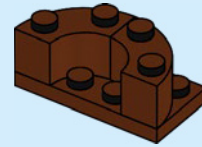

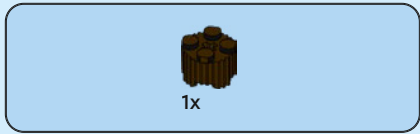

15

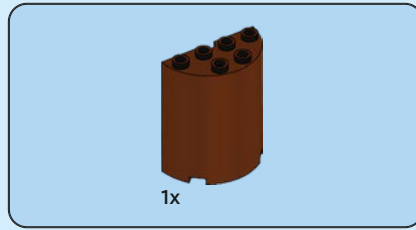
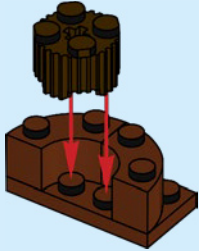

16

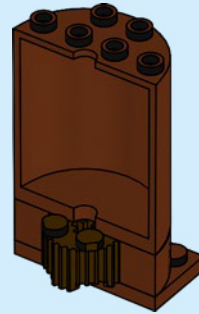

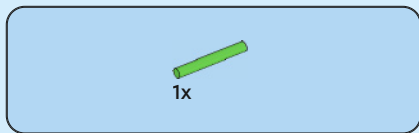

17



18

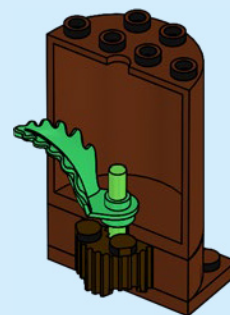



19



20



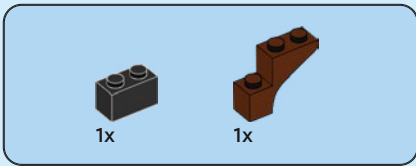

21

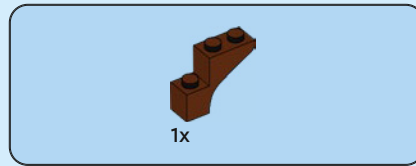
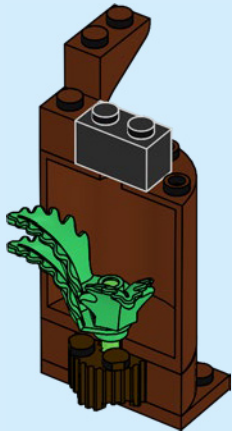

22





1x

23

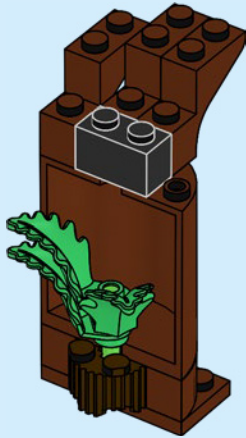

1x

24

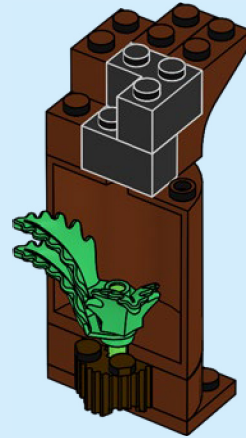

25

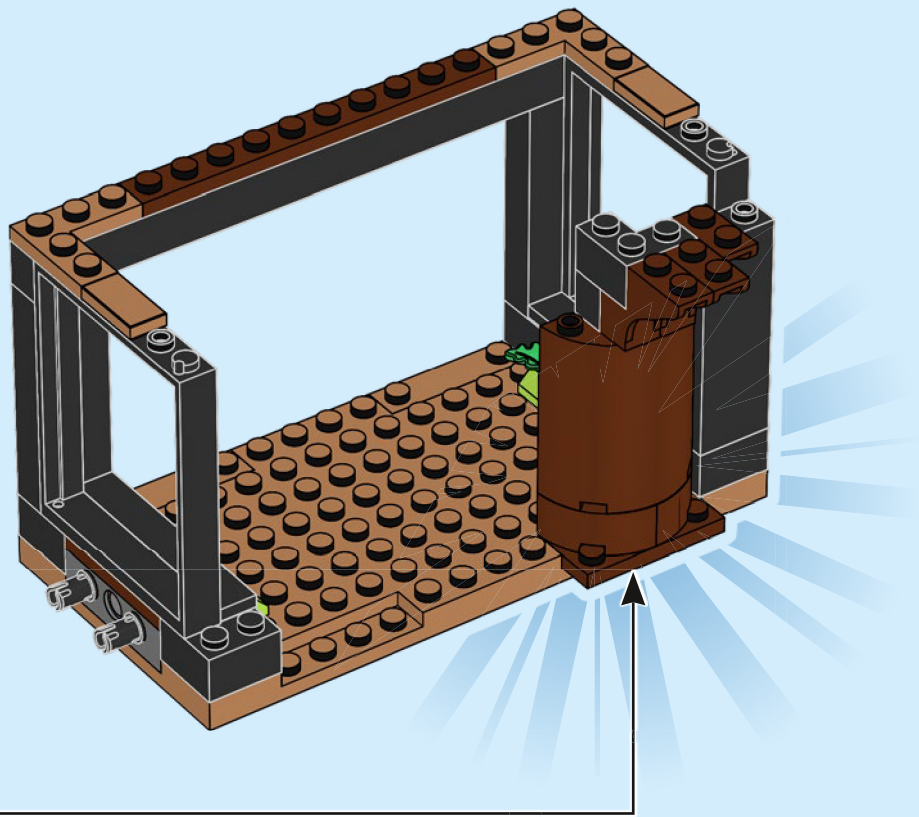

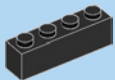

1x

26

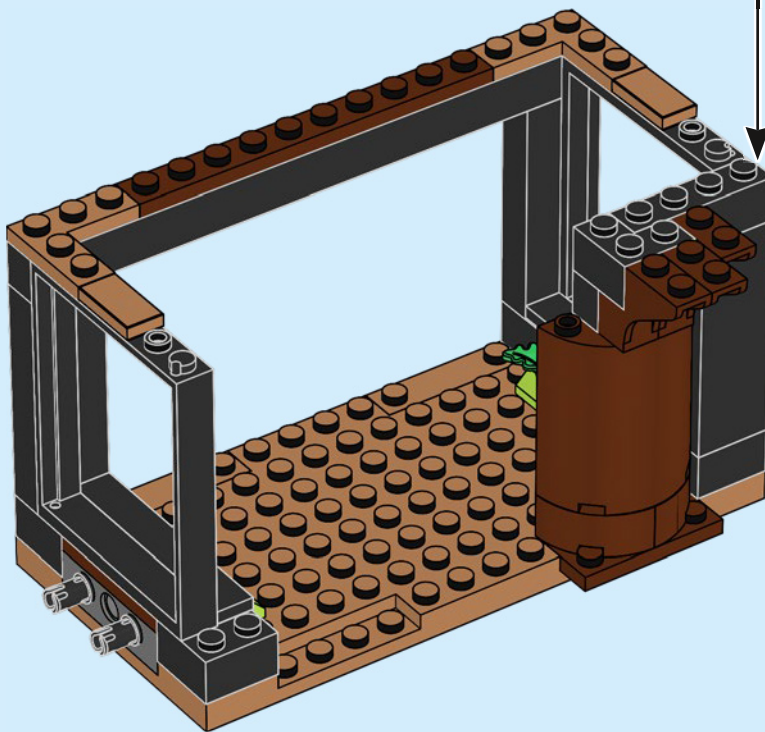
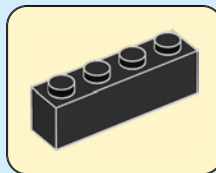

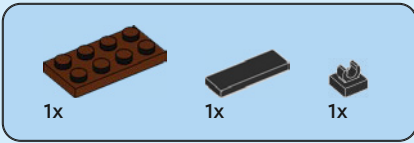

27

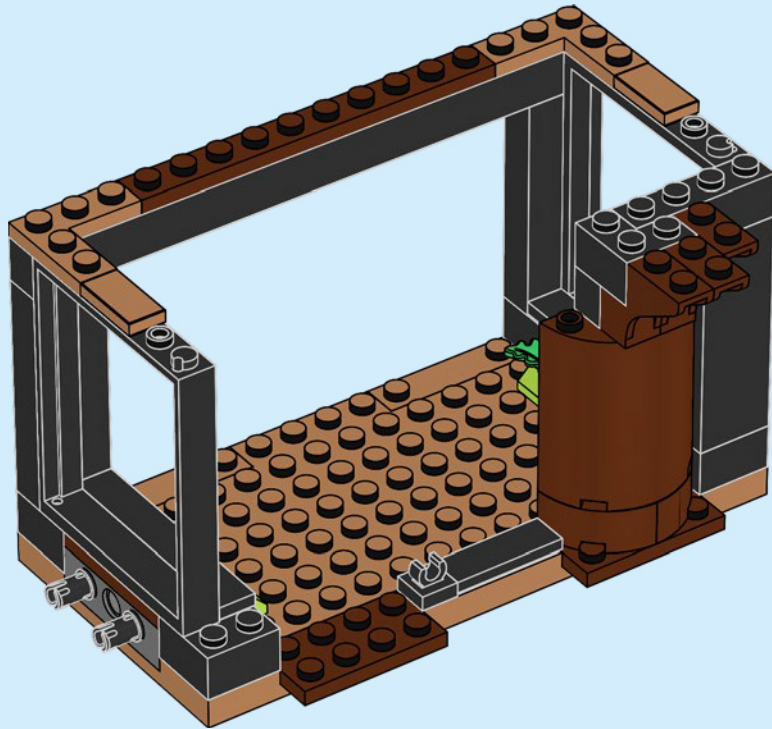

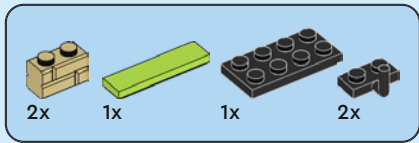

28

1

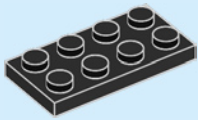

2

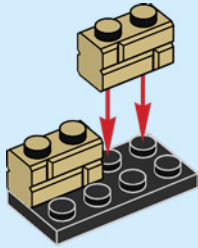

3

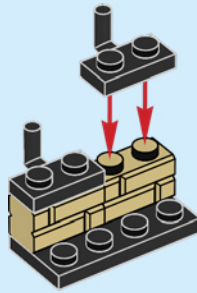

4

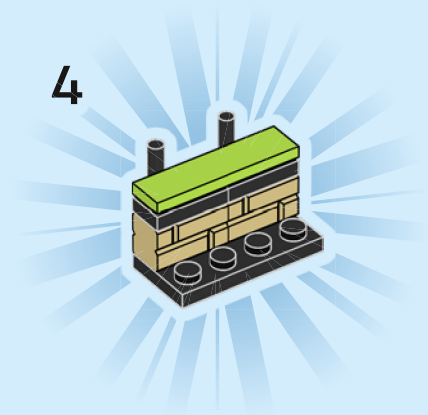

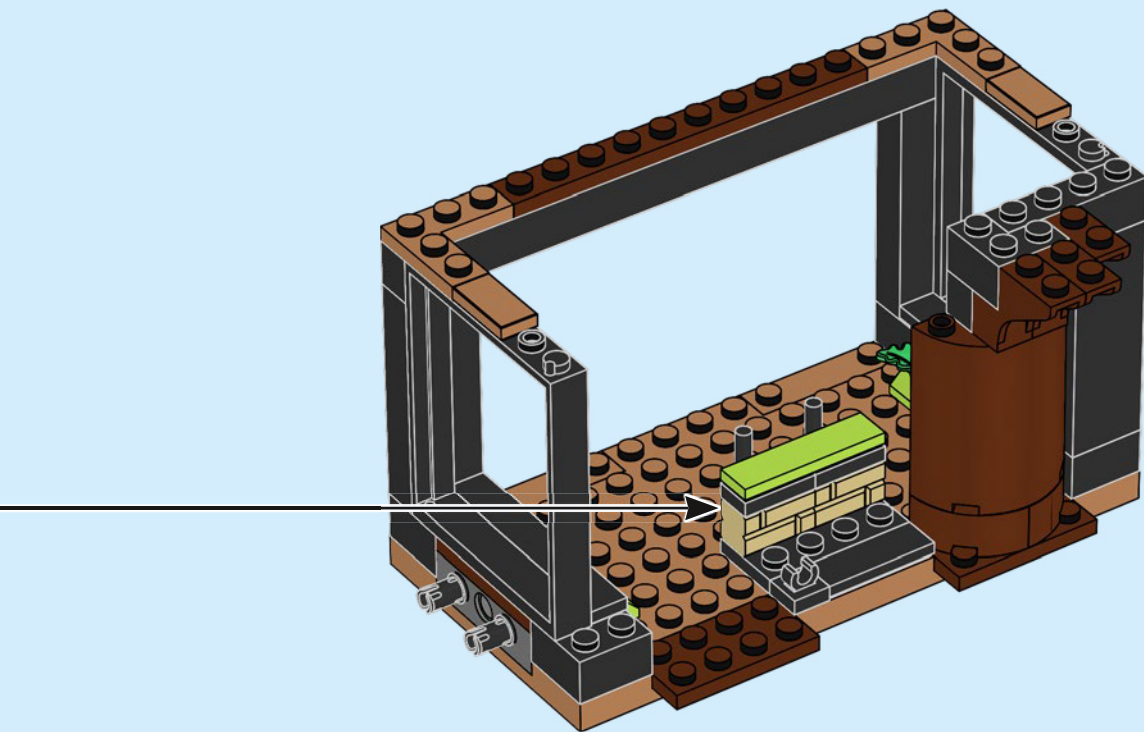

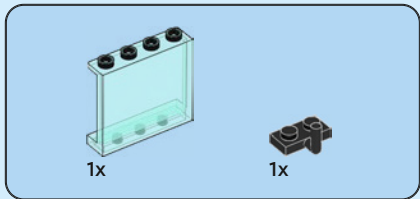

29

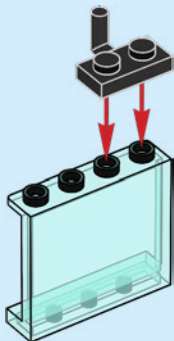

30

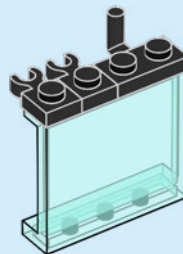

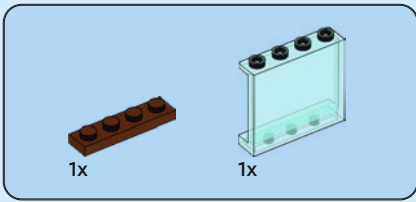

31

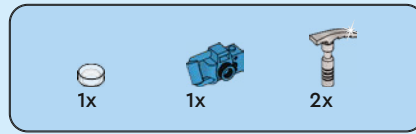
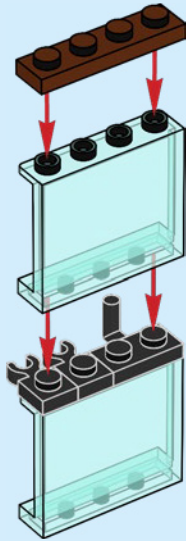

32

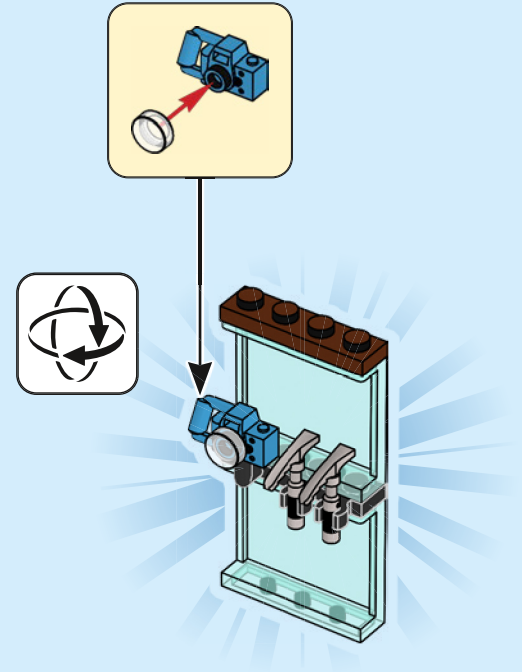

33

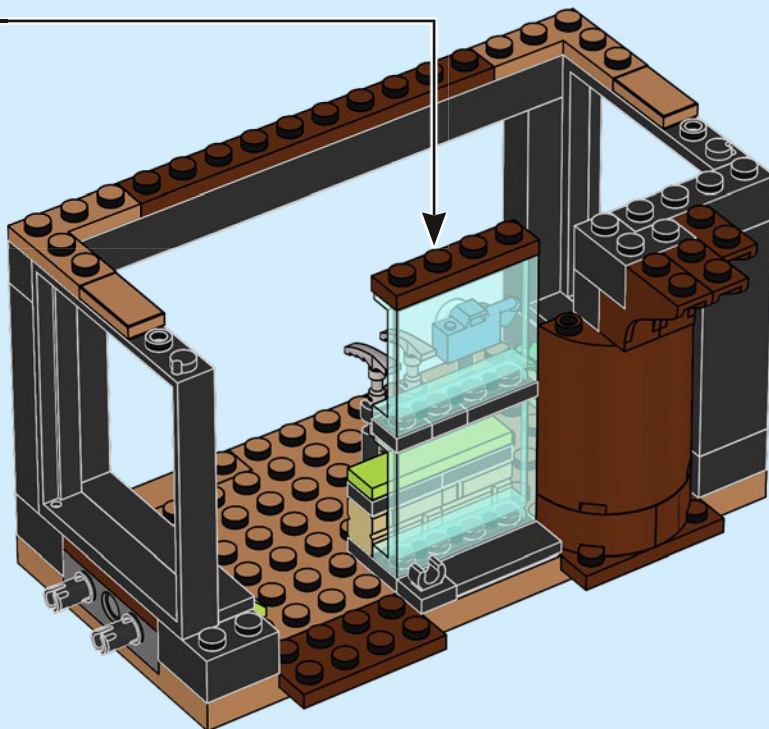



1x

34

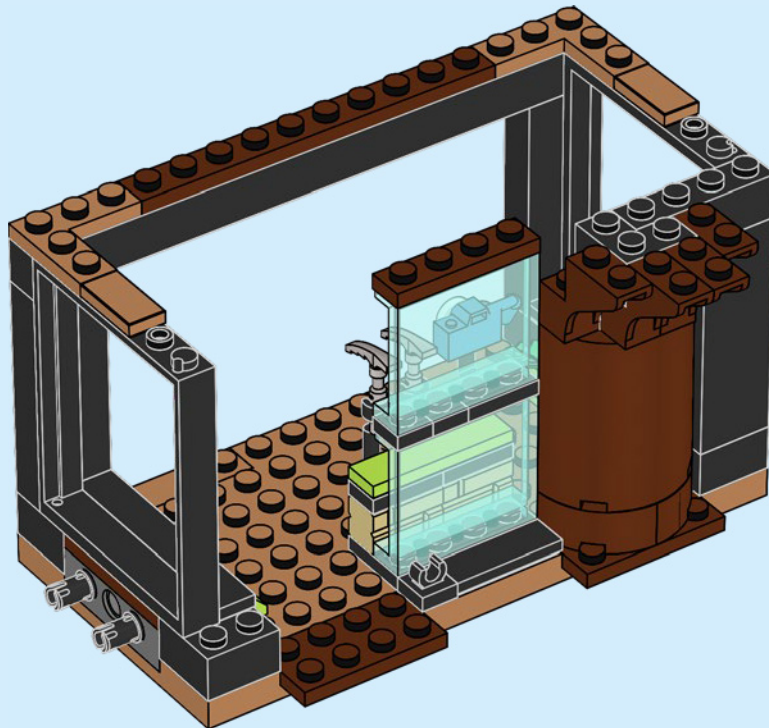



1x

35

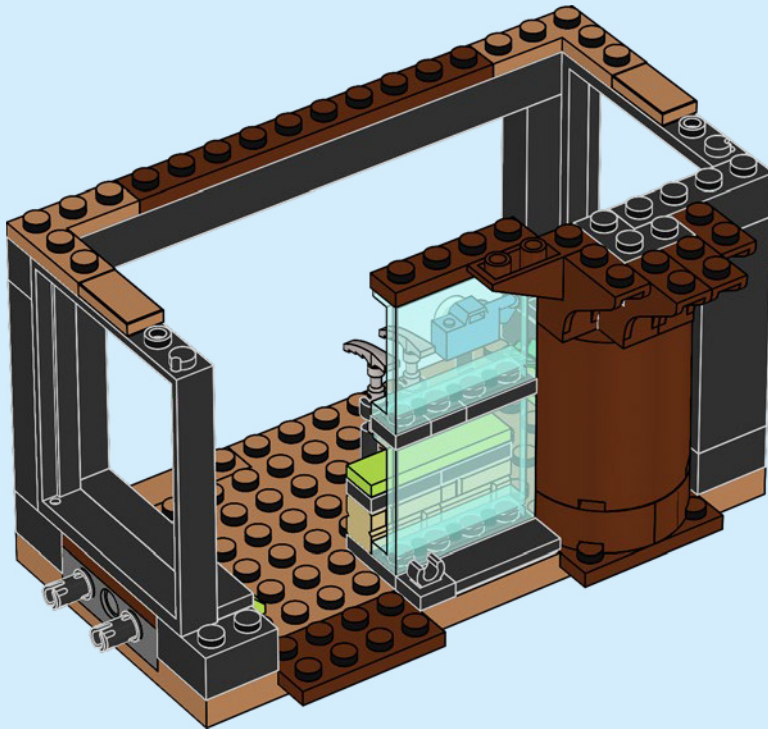



1x



3x

36

1

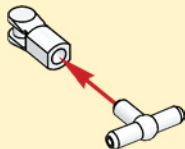

2

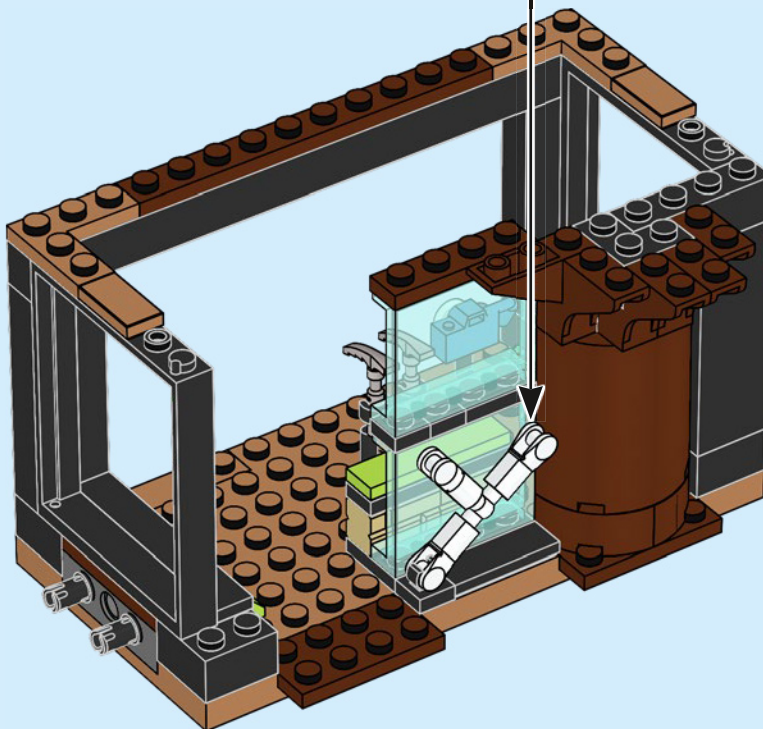
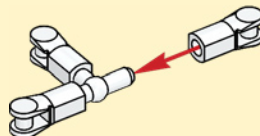

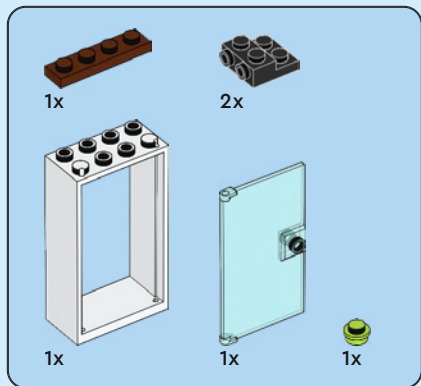

37

1

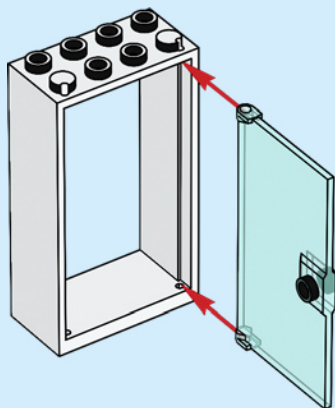

2

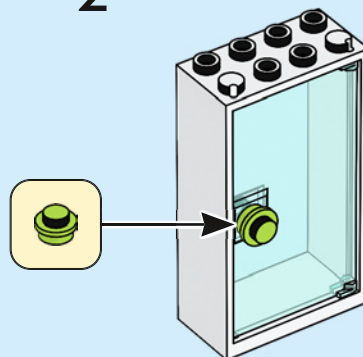

3

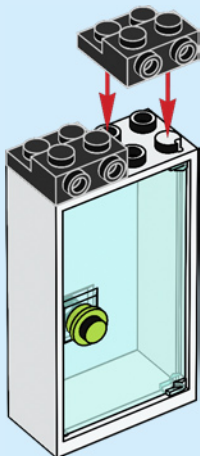

4

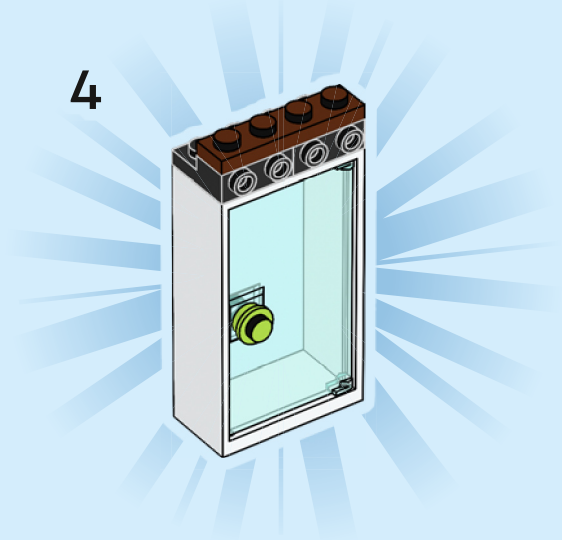

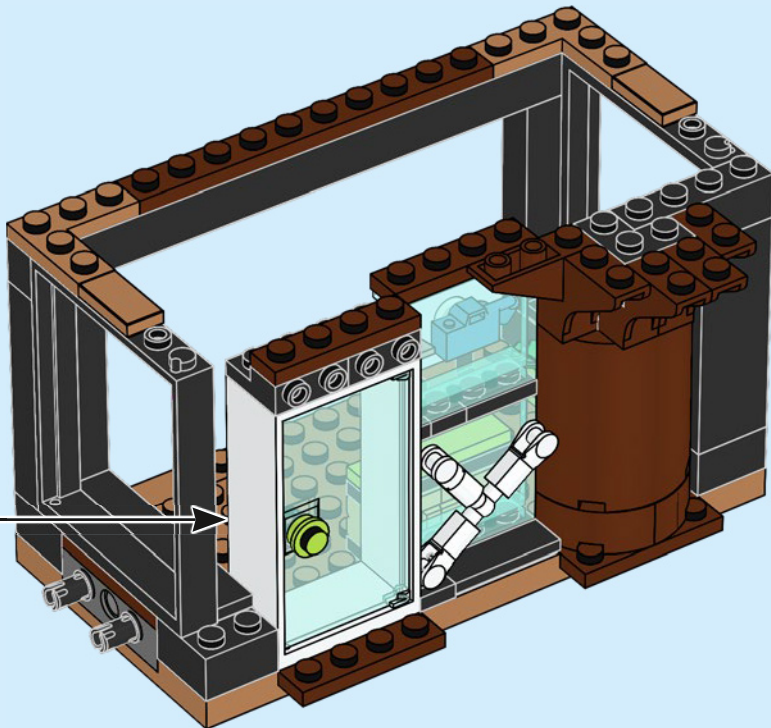

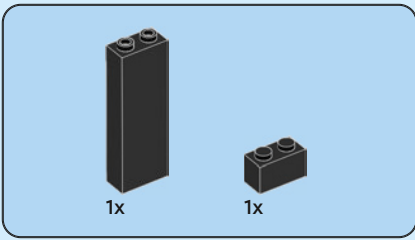

38

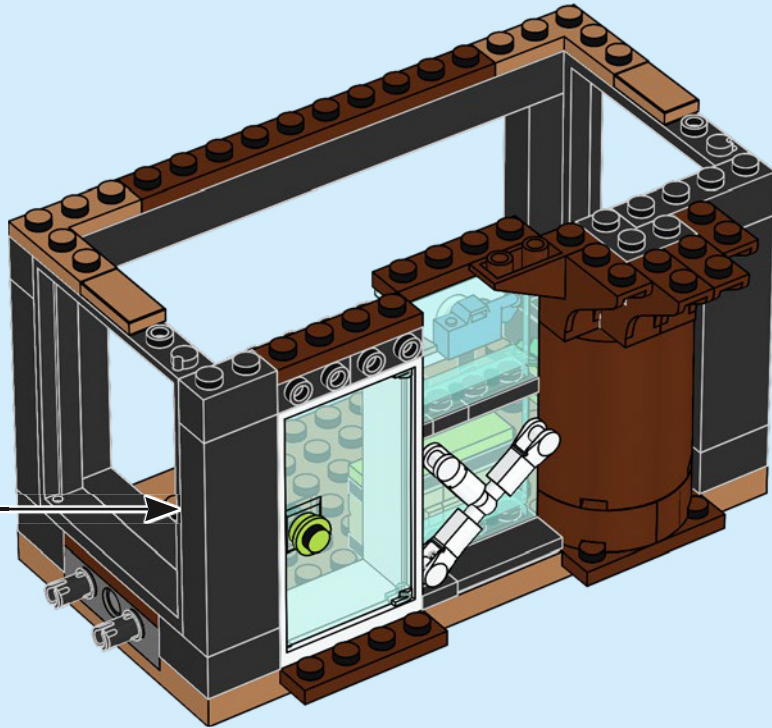
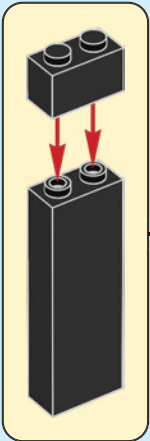

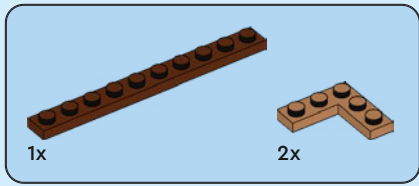

39

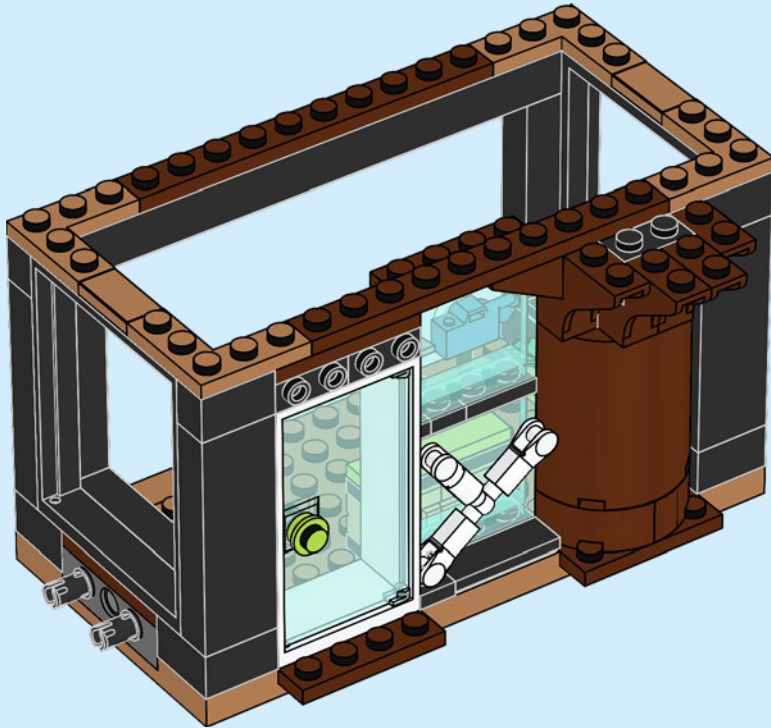



2x

40

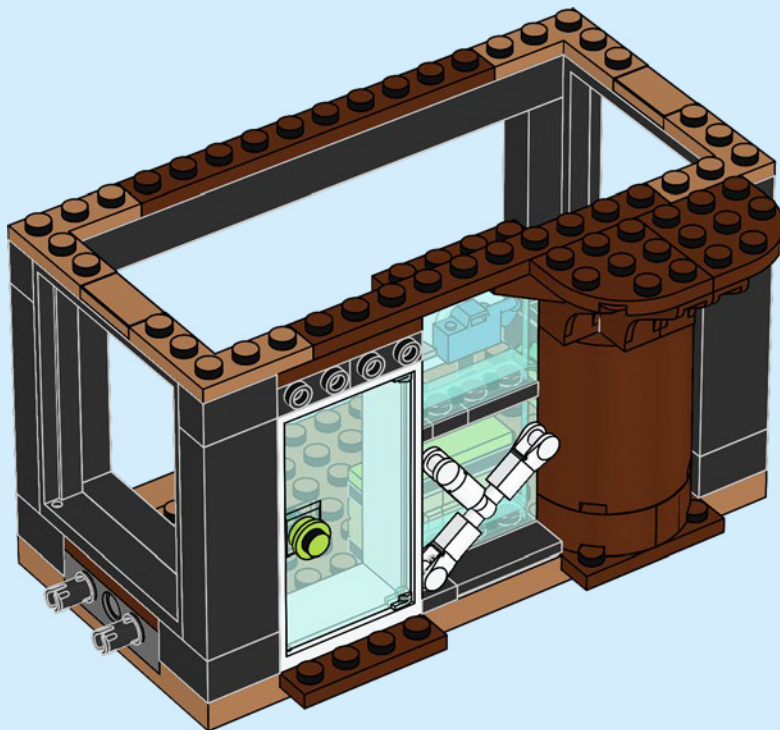

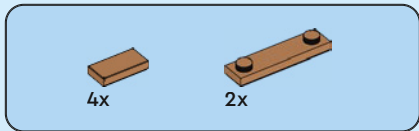

41

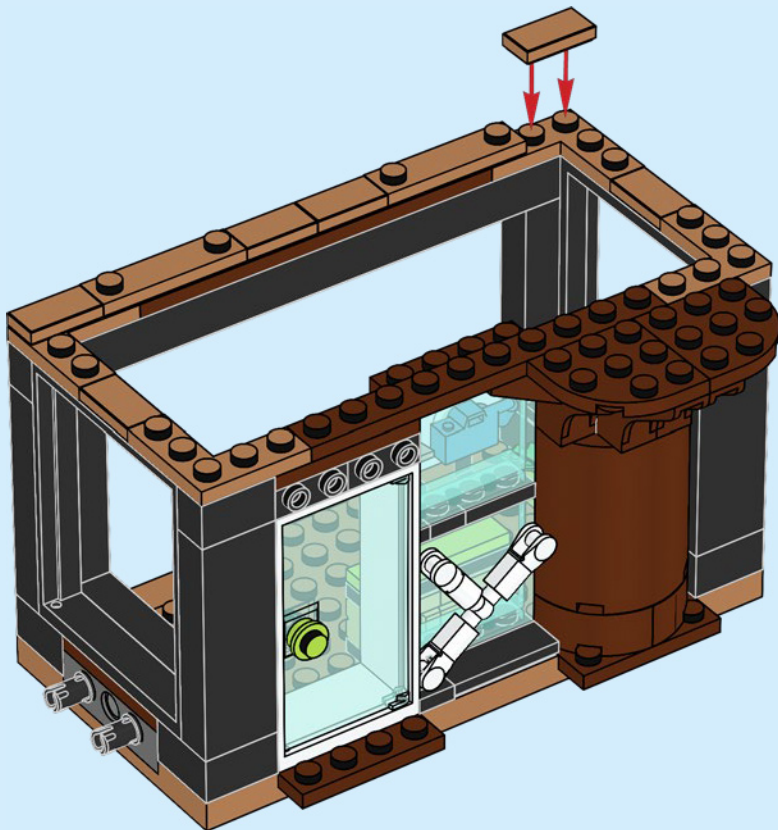

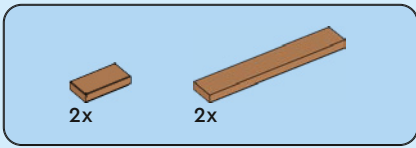

42

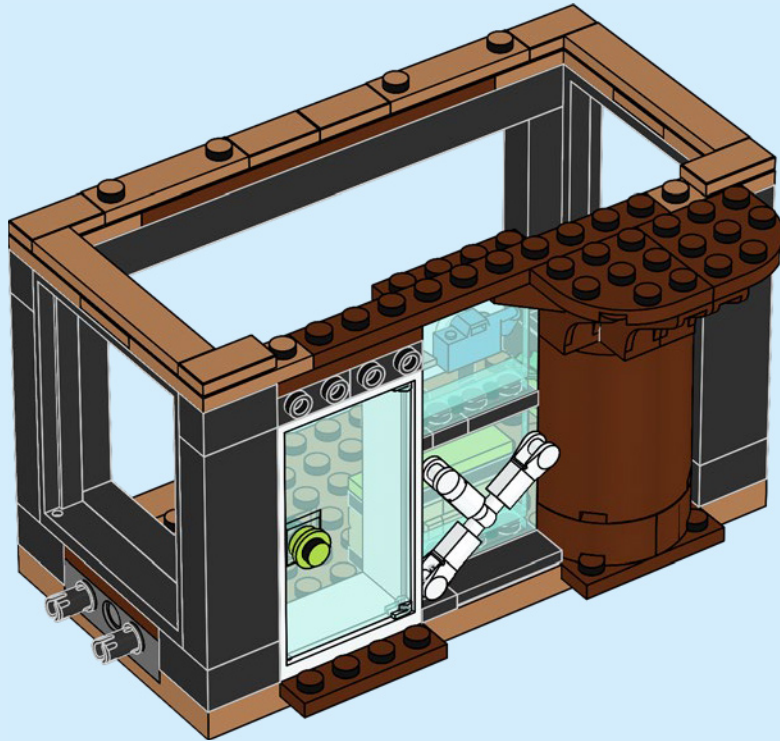



2x

43

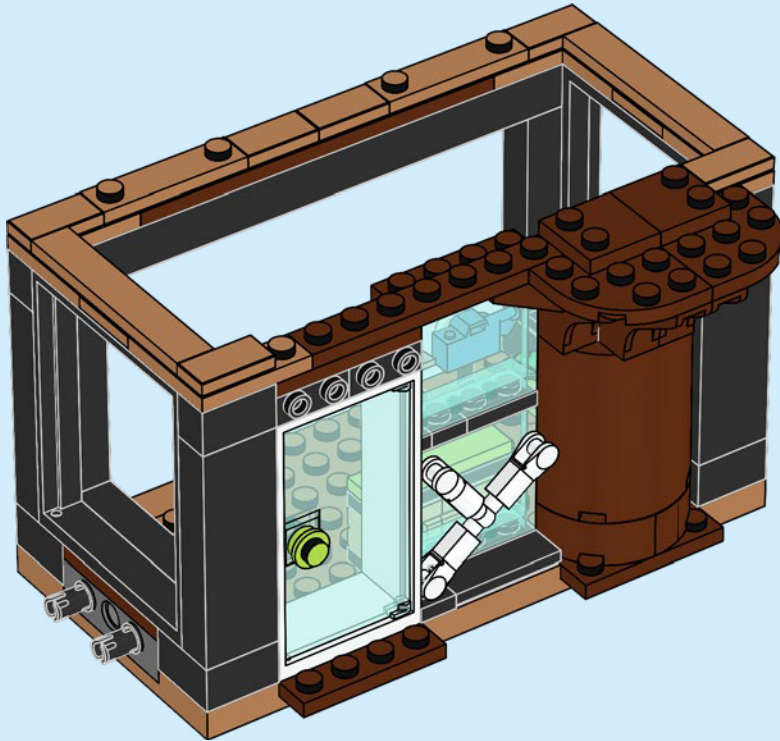



2x



2x

44

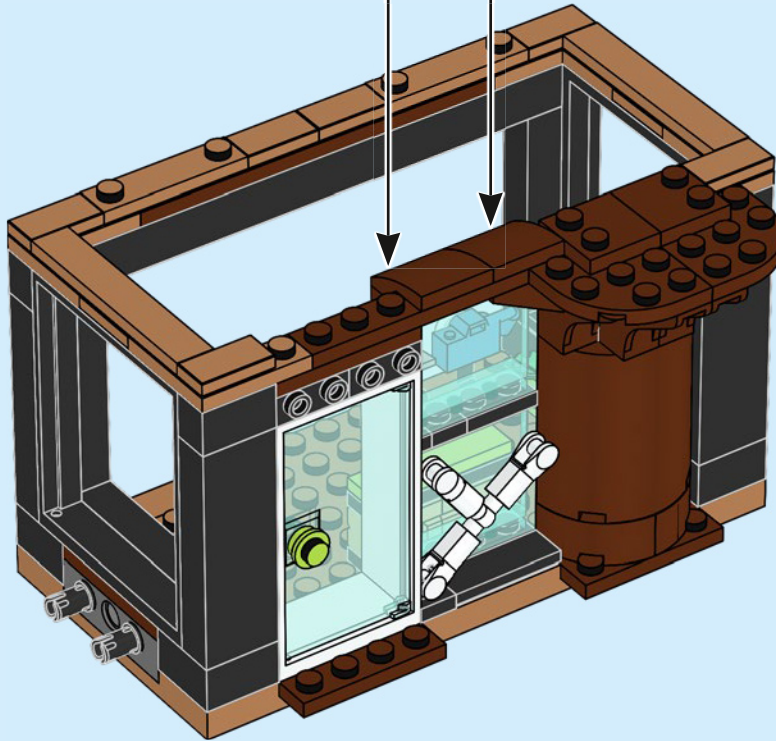



2x

45

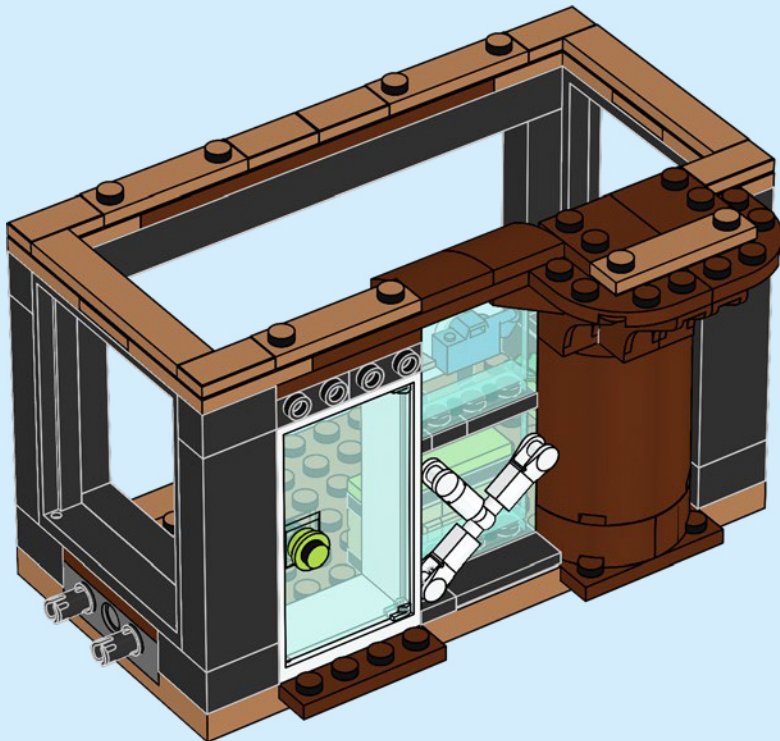



4x

46

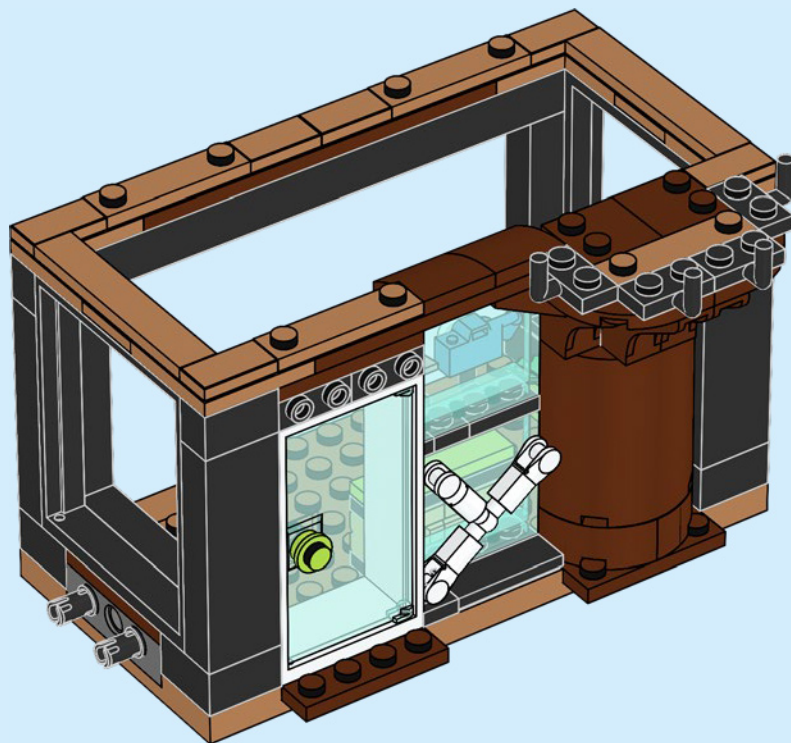



2x

47

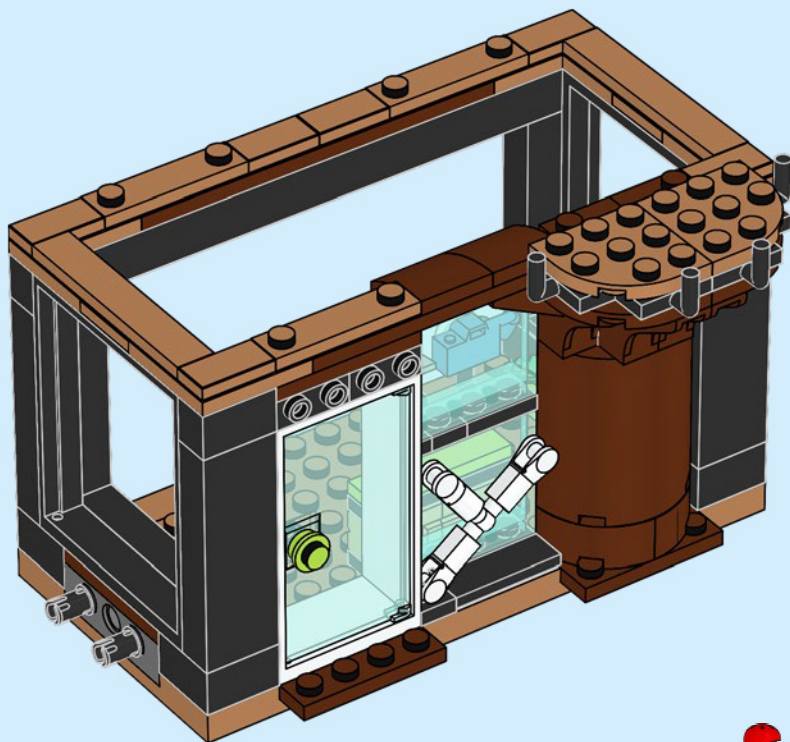

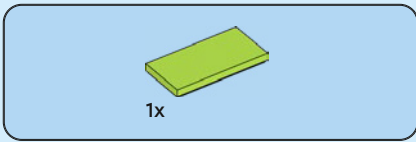

48

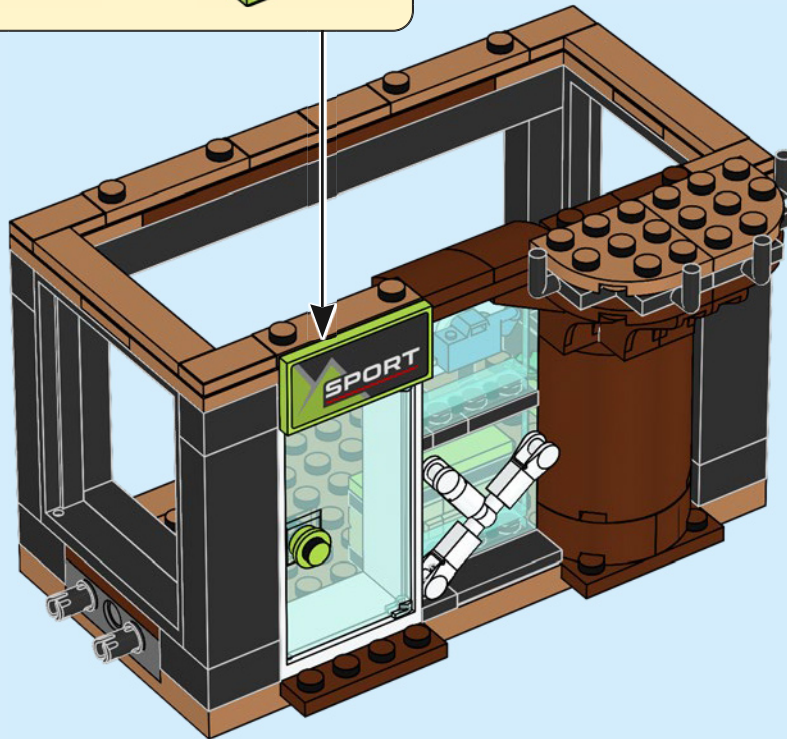
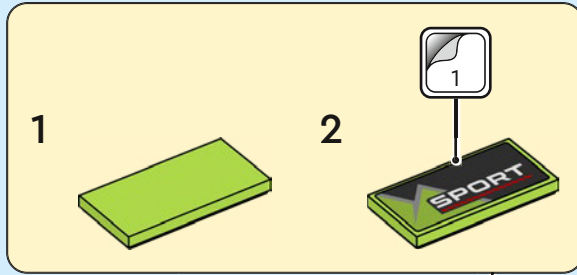



2x

49

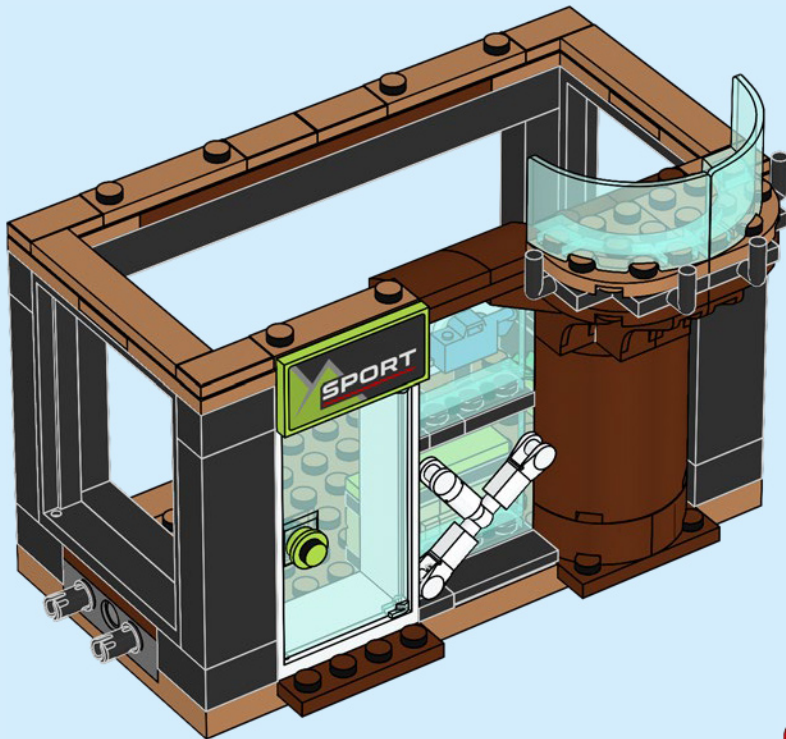



2x



1x

50

1



2

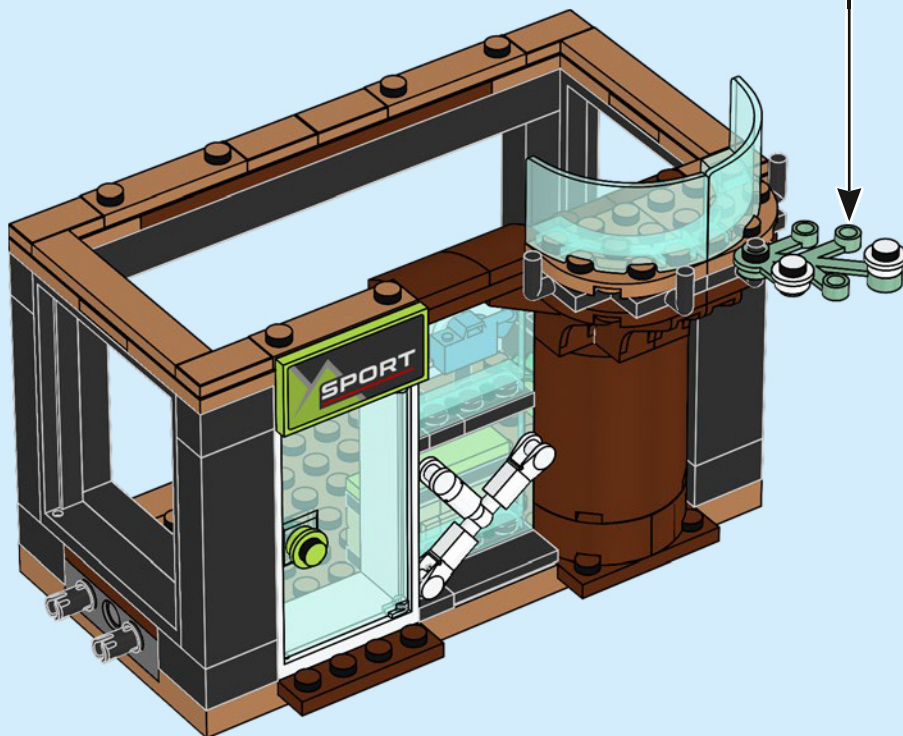

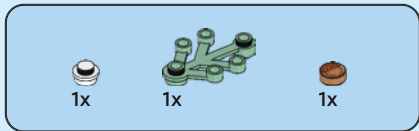

51

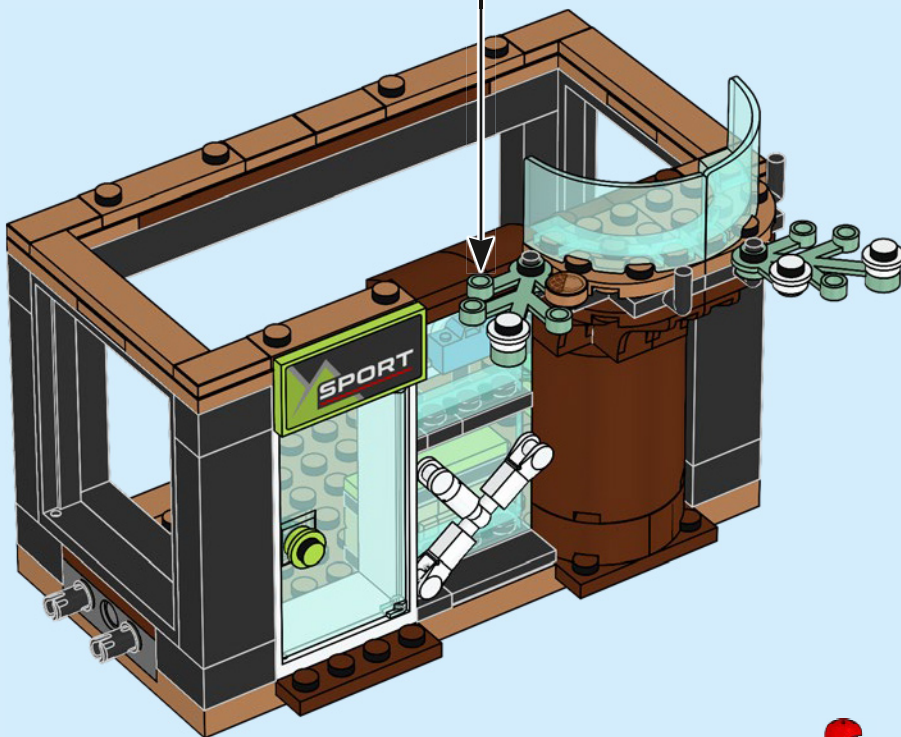
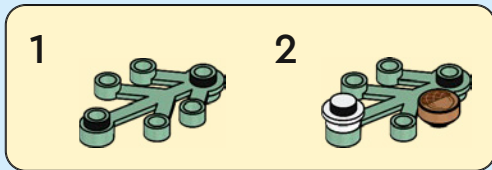

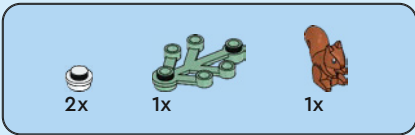

52

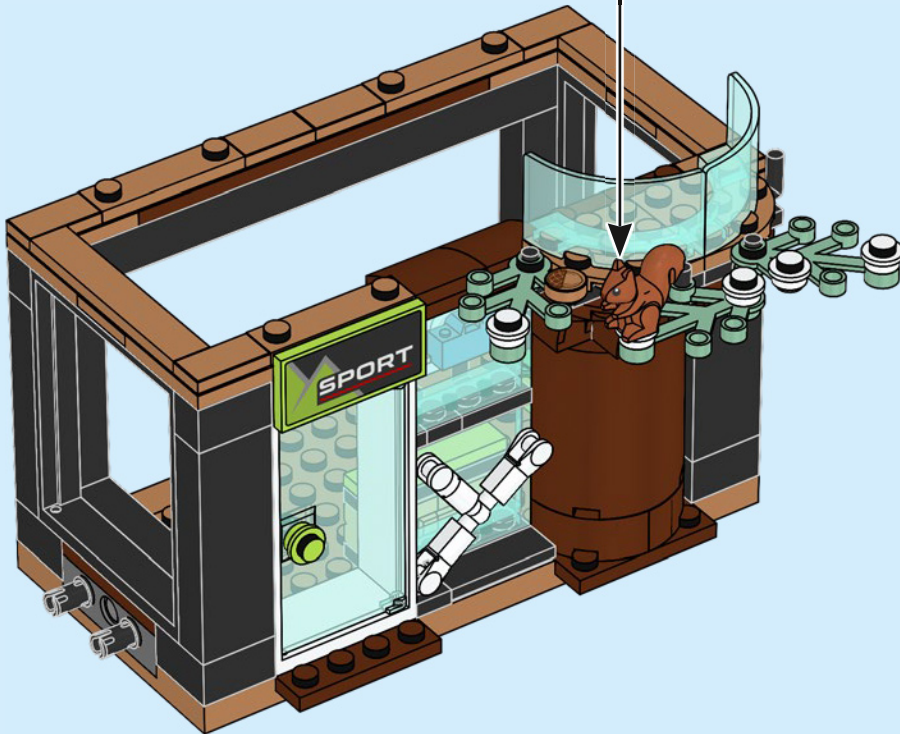
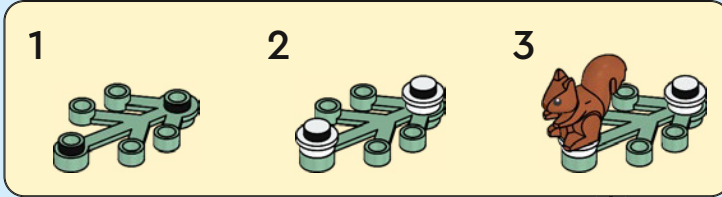

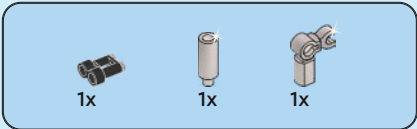

53

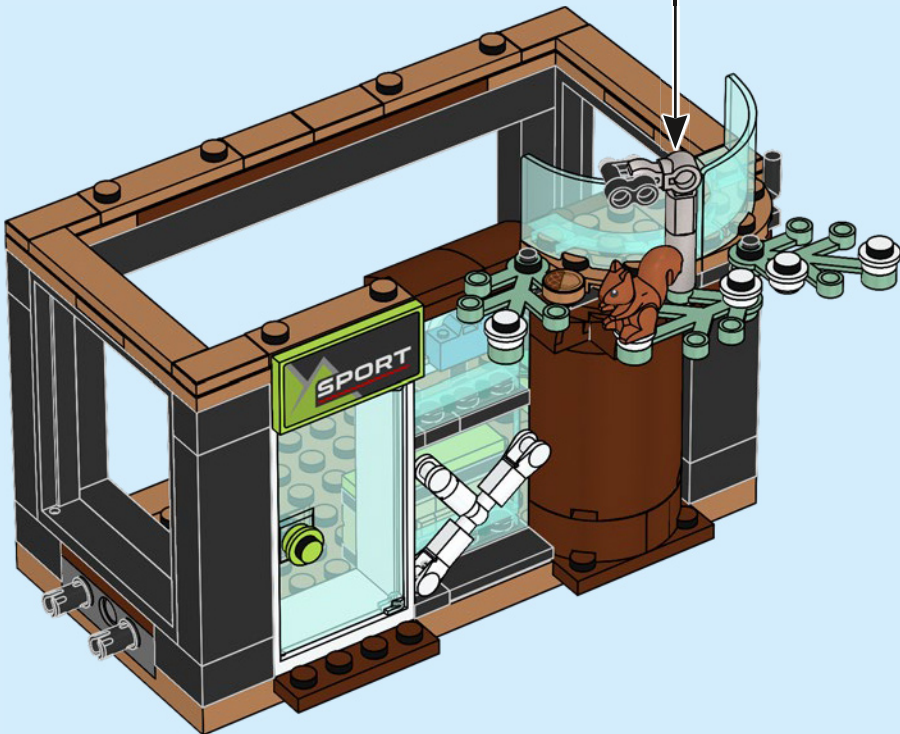
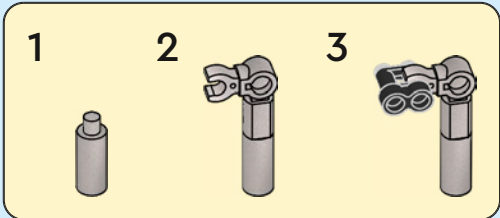



1x



1x

54

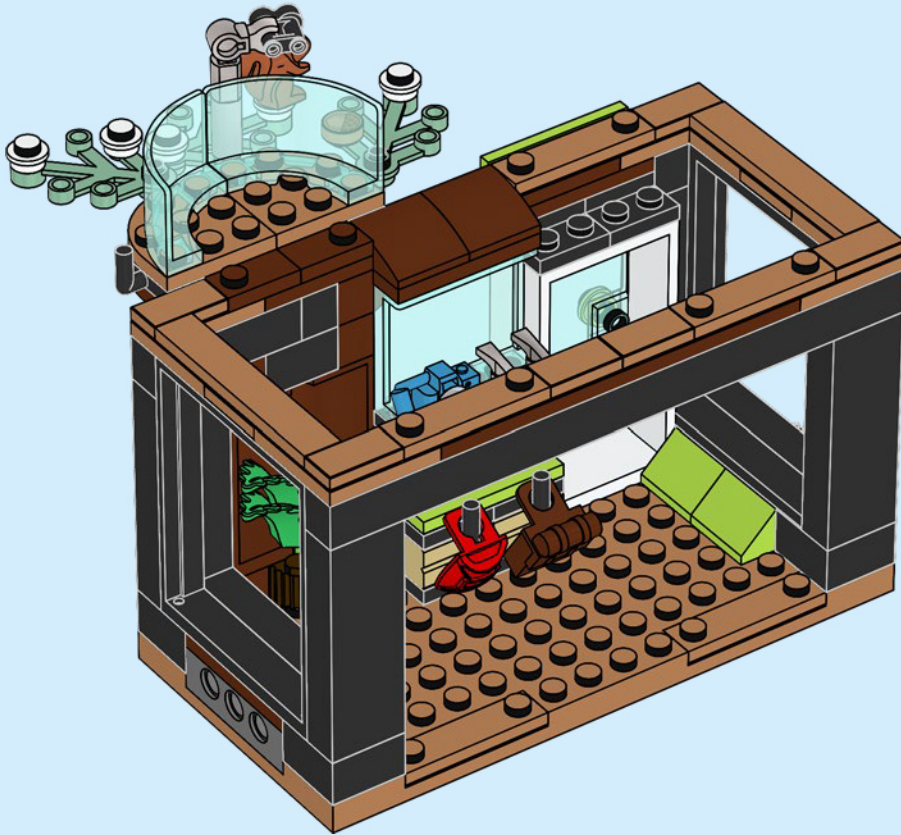

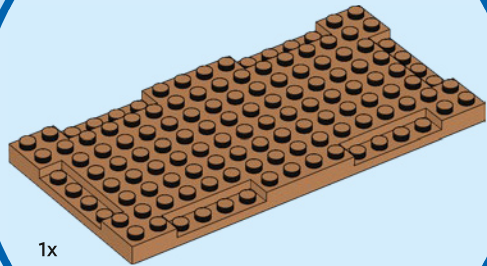
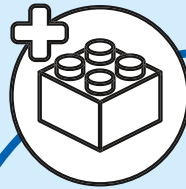

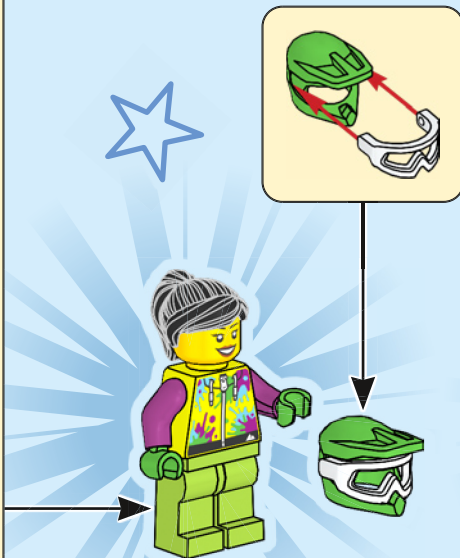
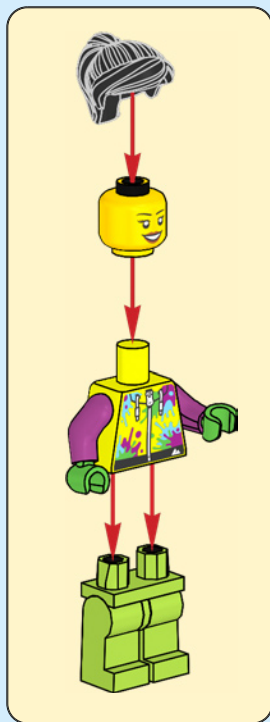

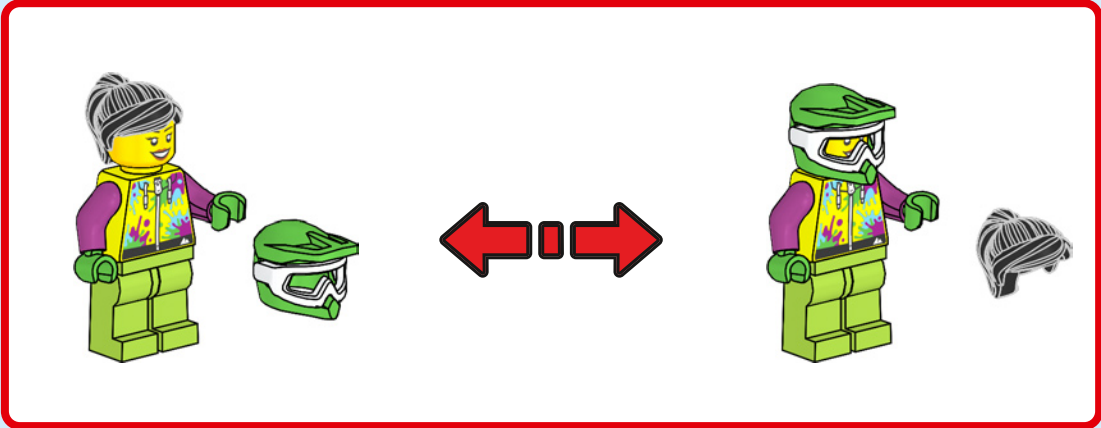

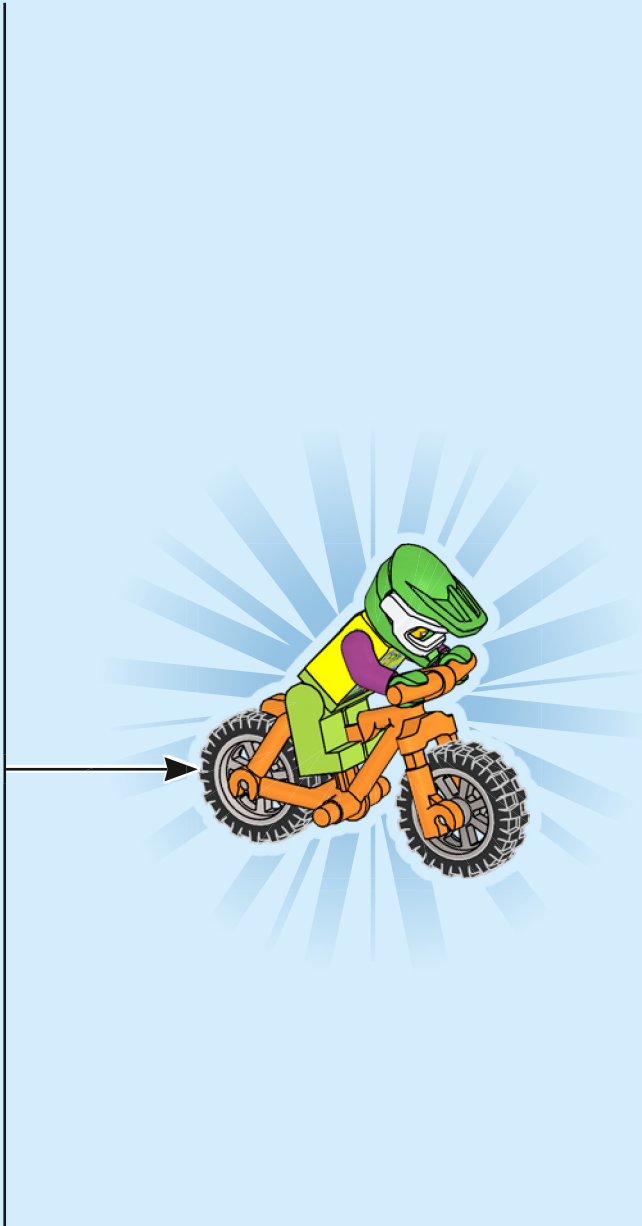
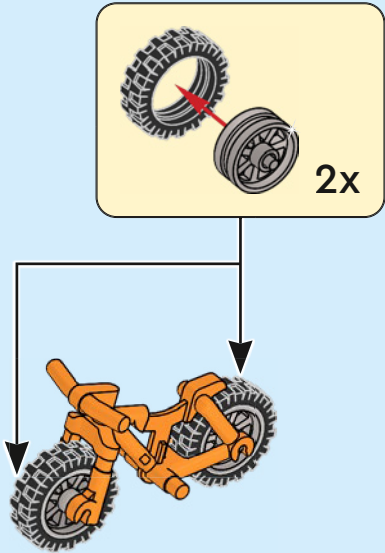

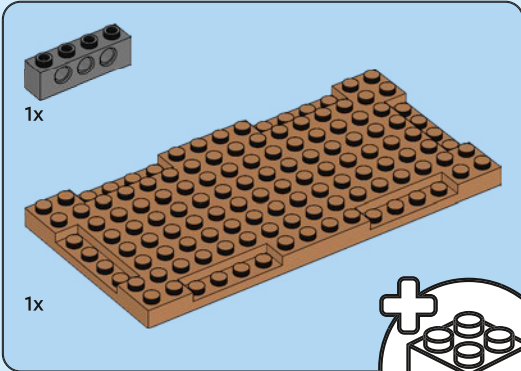
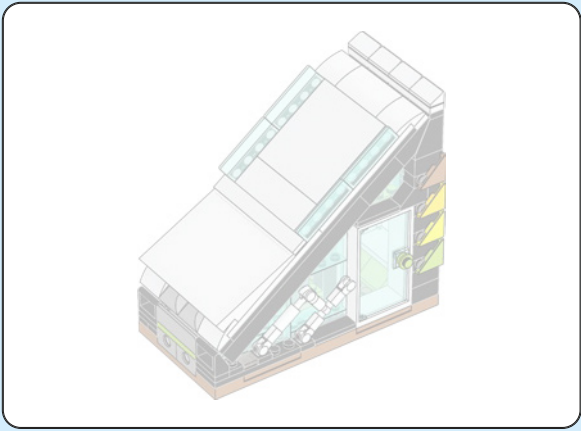

55

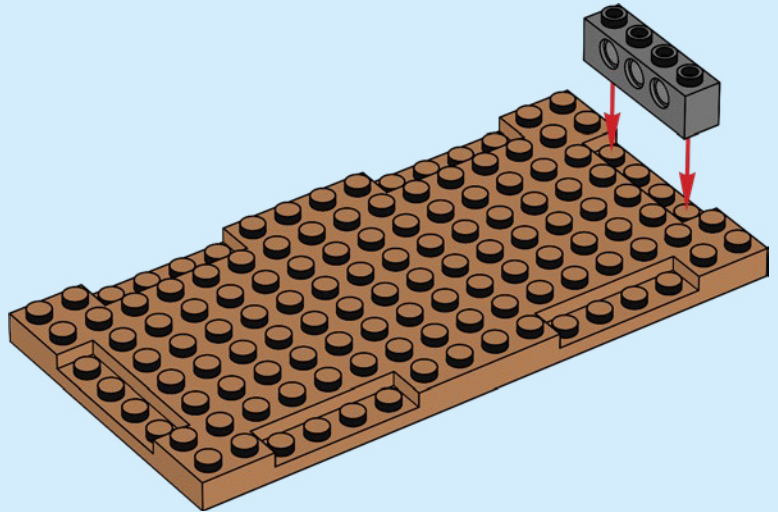

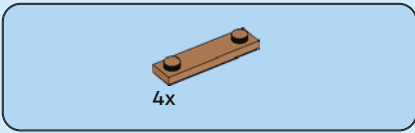

56

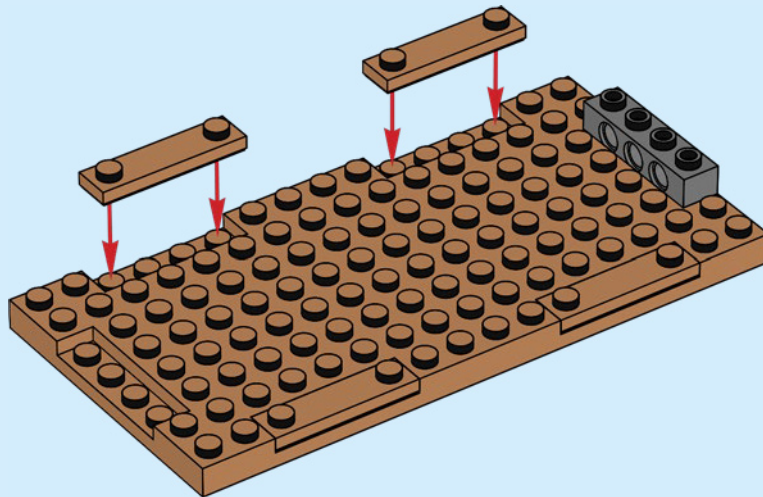

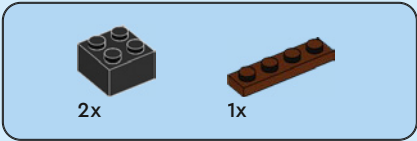

57

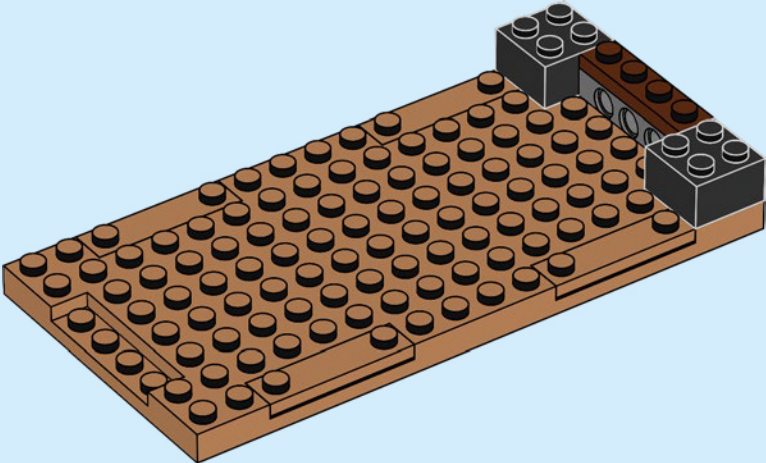



2x

58

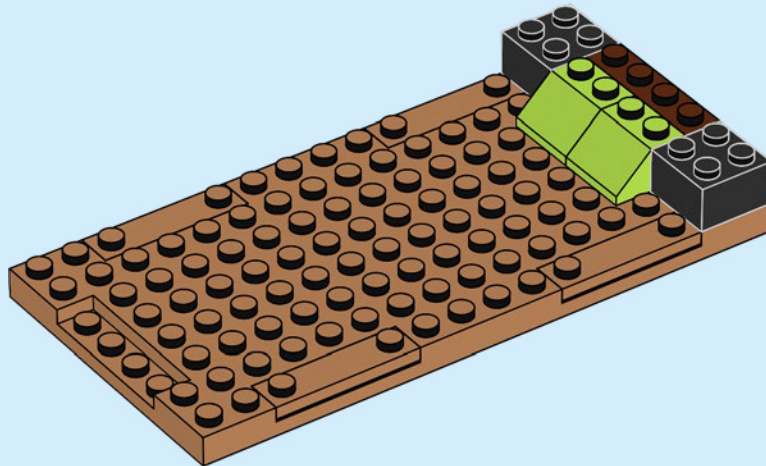

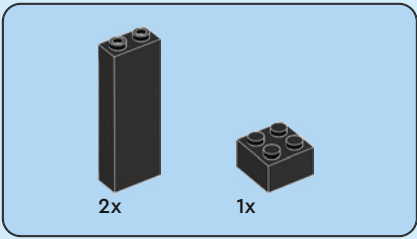

59

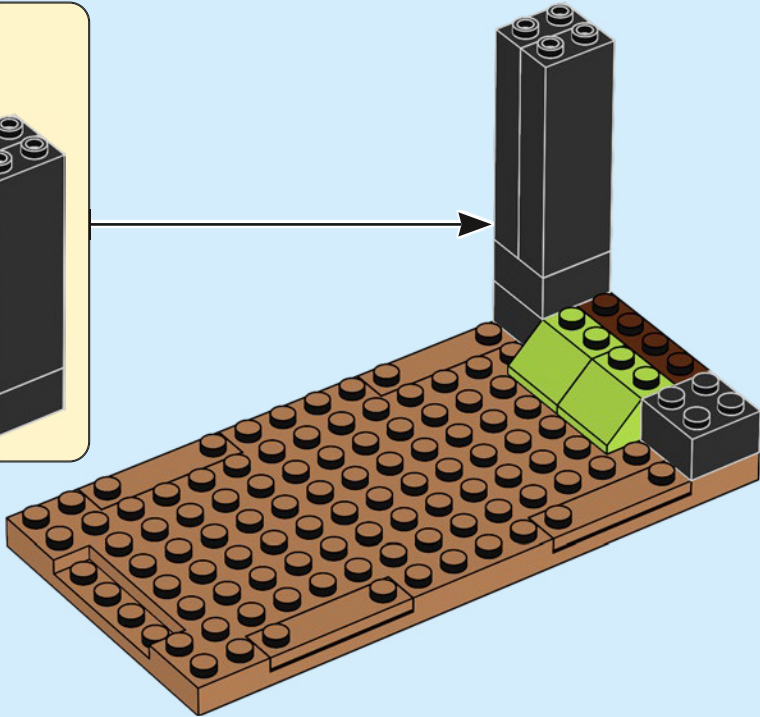
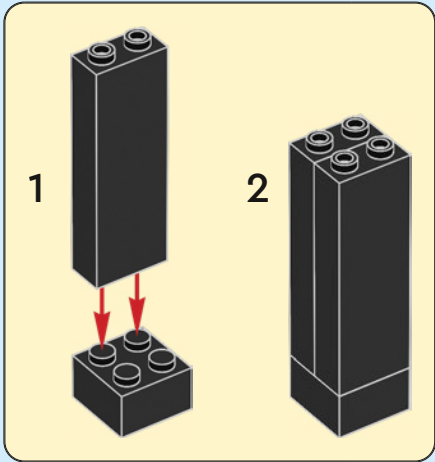

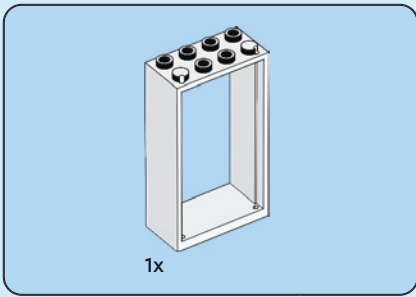

60

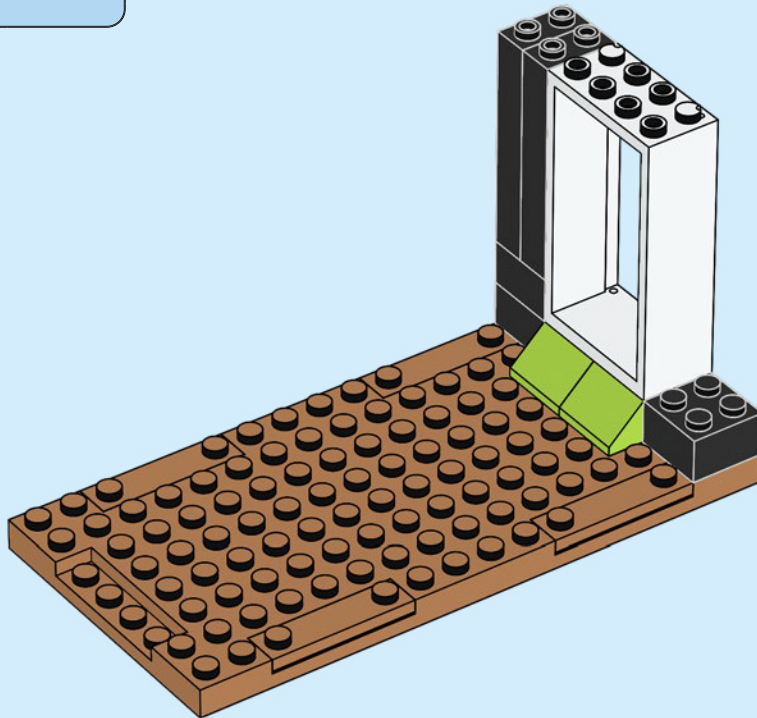

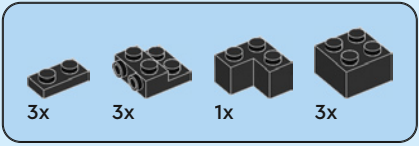

61

1

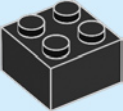

2

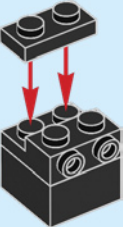

3

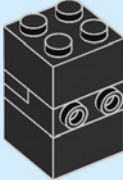

4

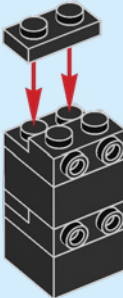

5

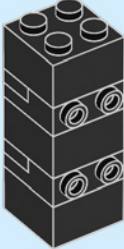

6

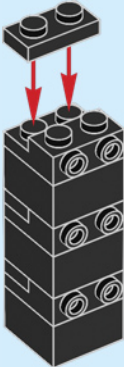

7

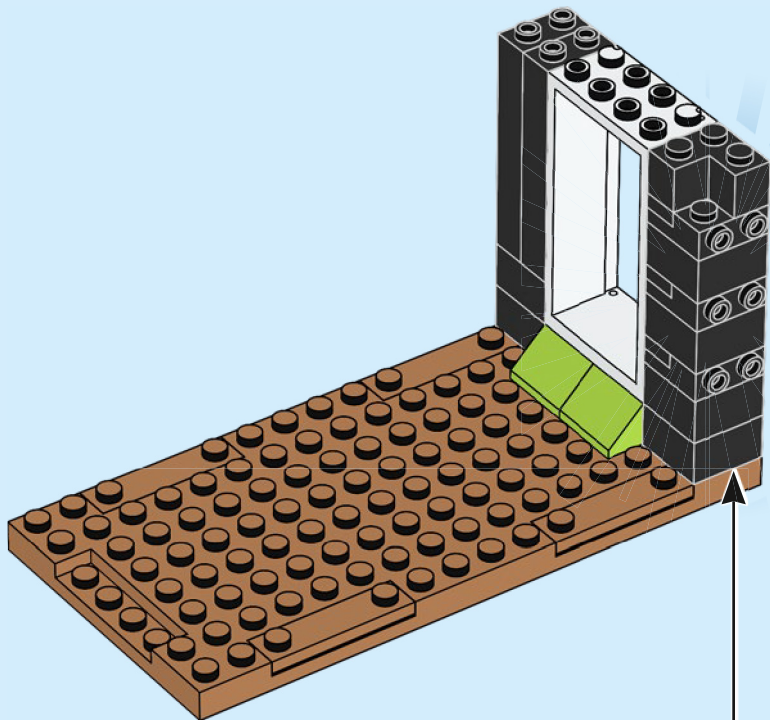
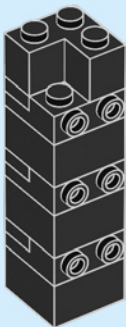

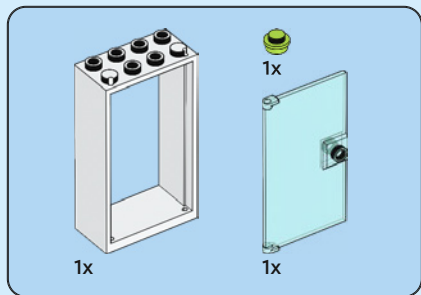

62

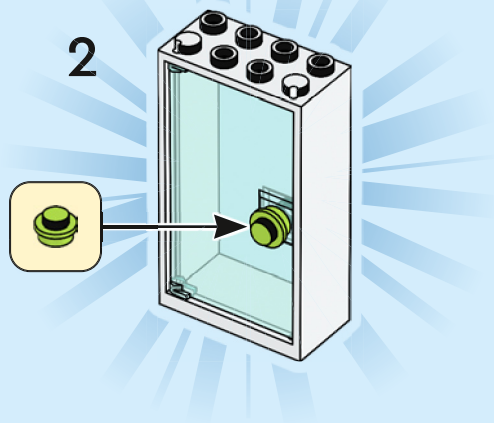
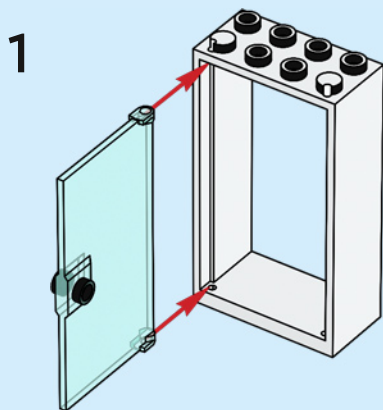

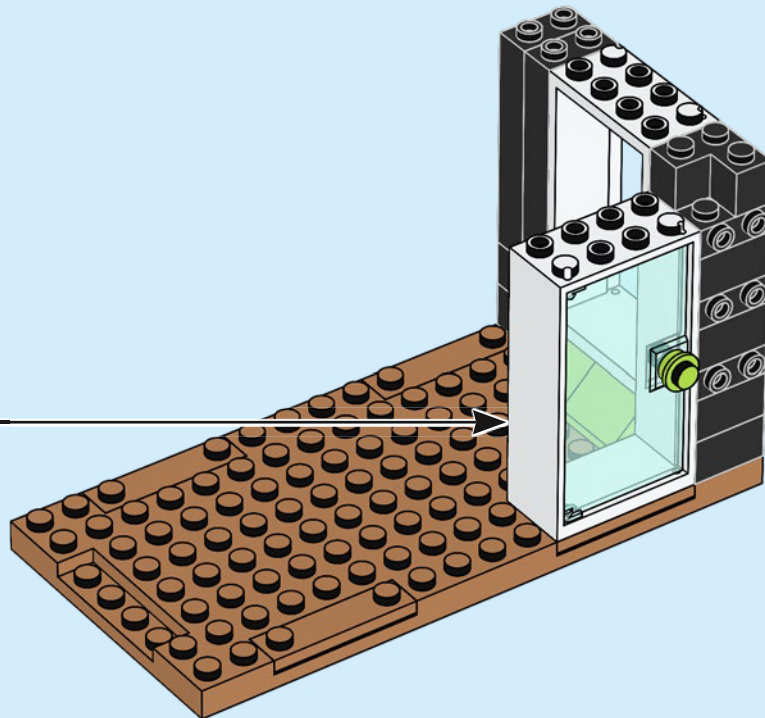



1x



1x

63

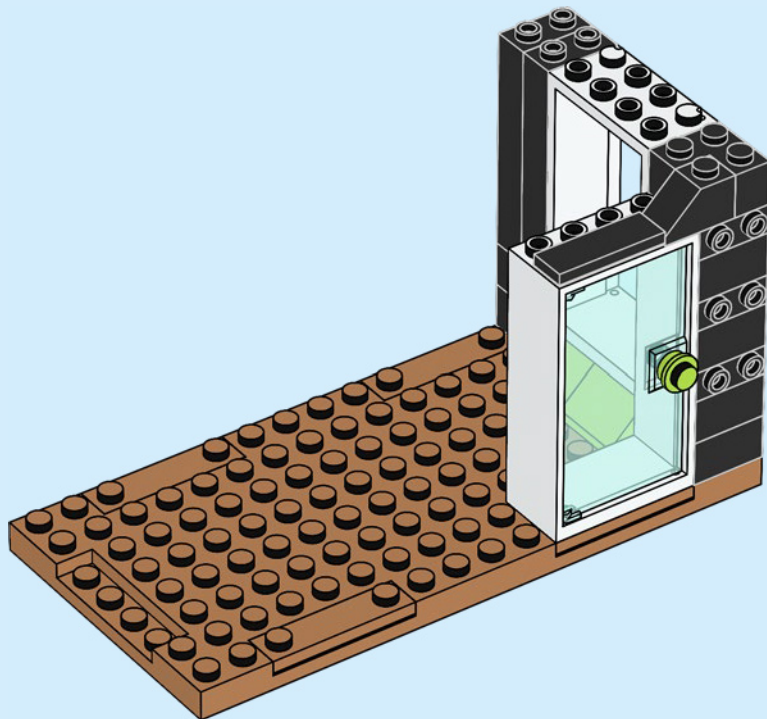

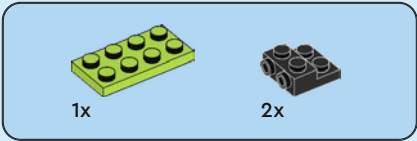

64

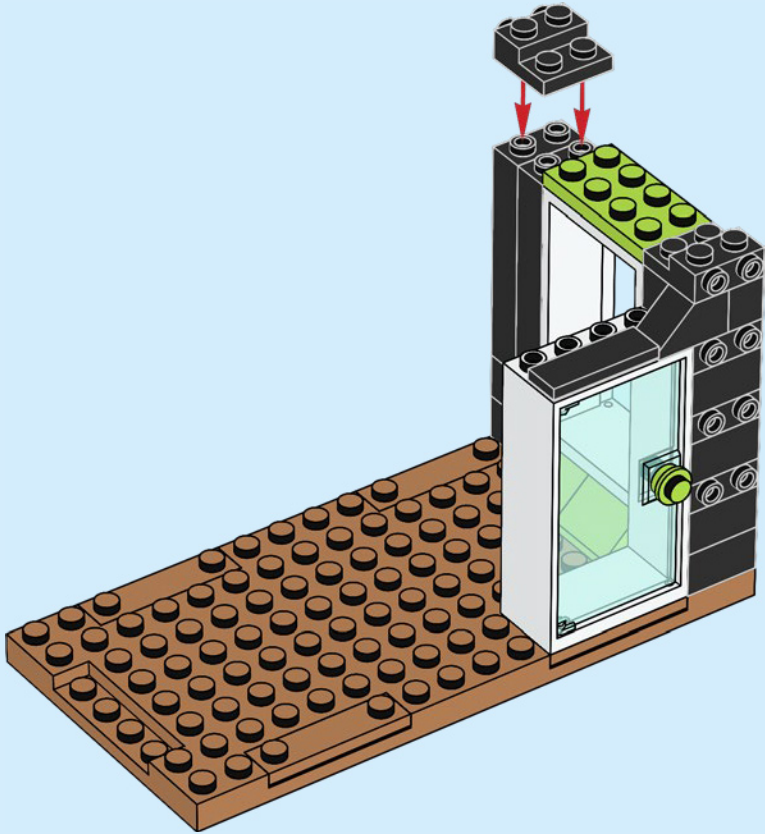

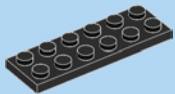

1x

65

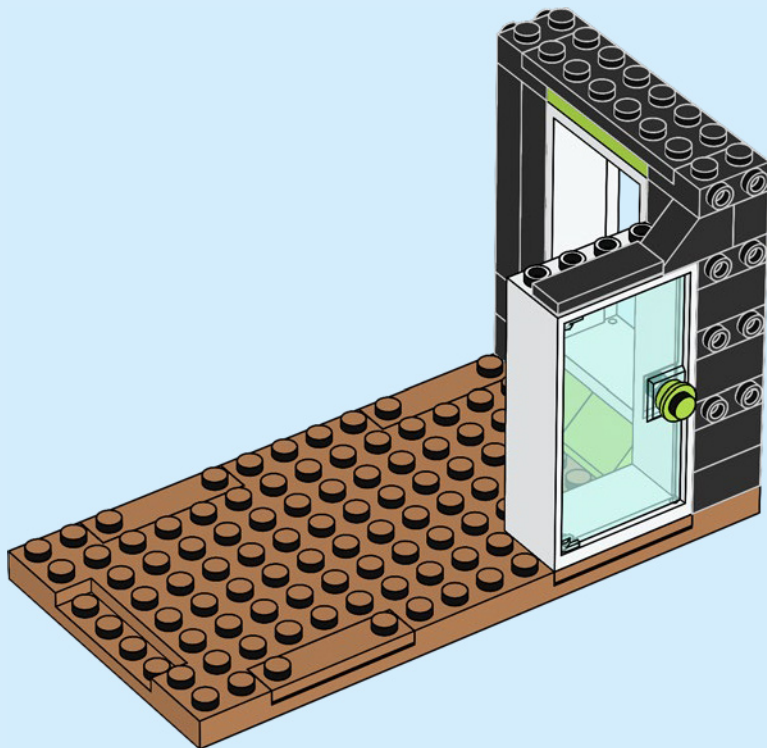

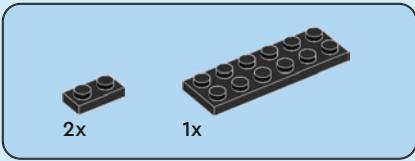

66

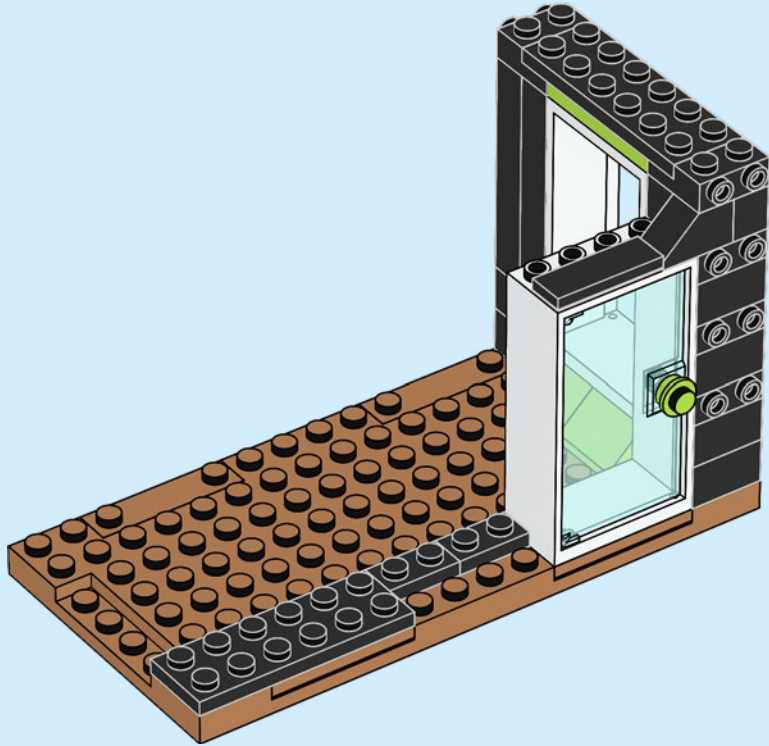



1x



1x

67

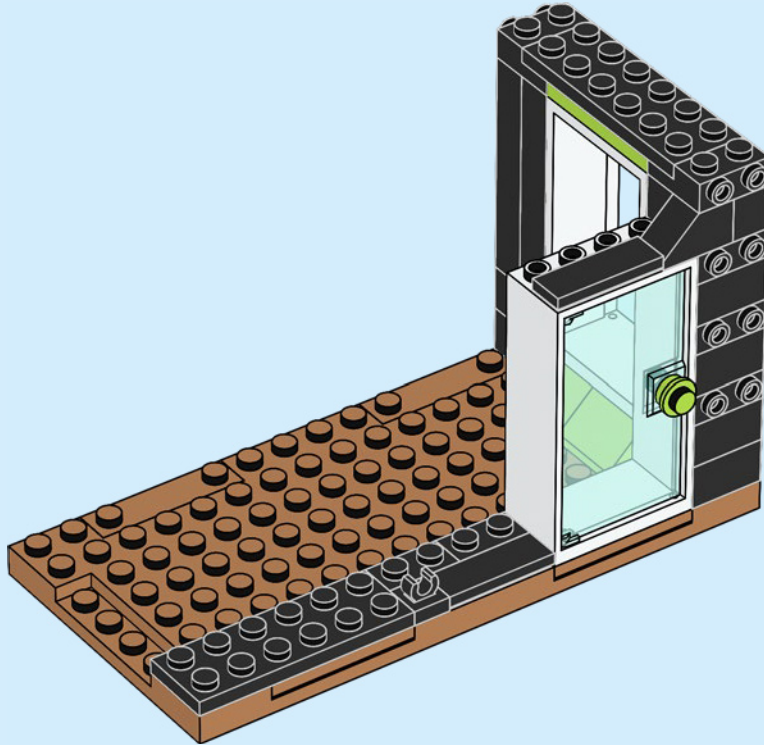



2x

68

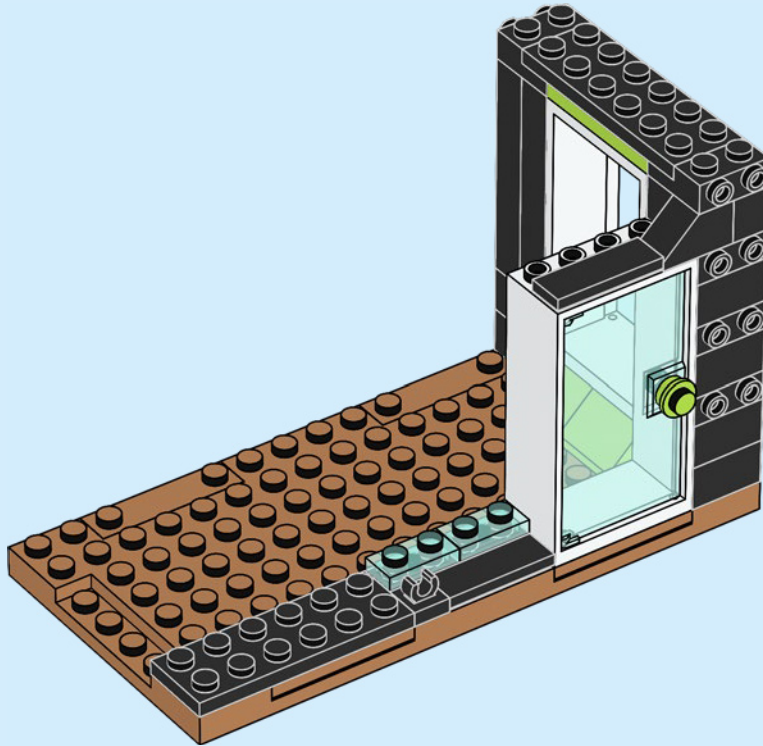



1x



1x

70

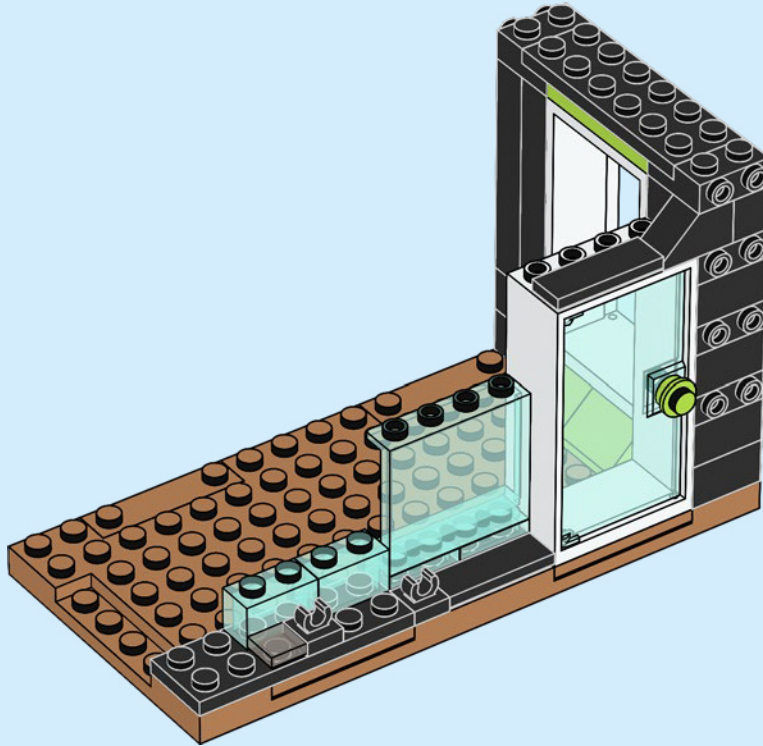

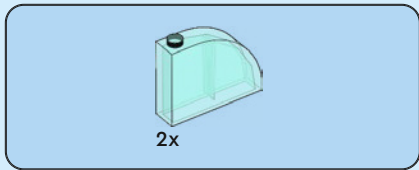

71

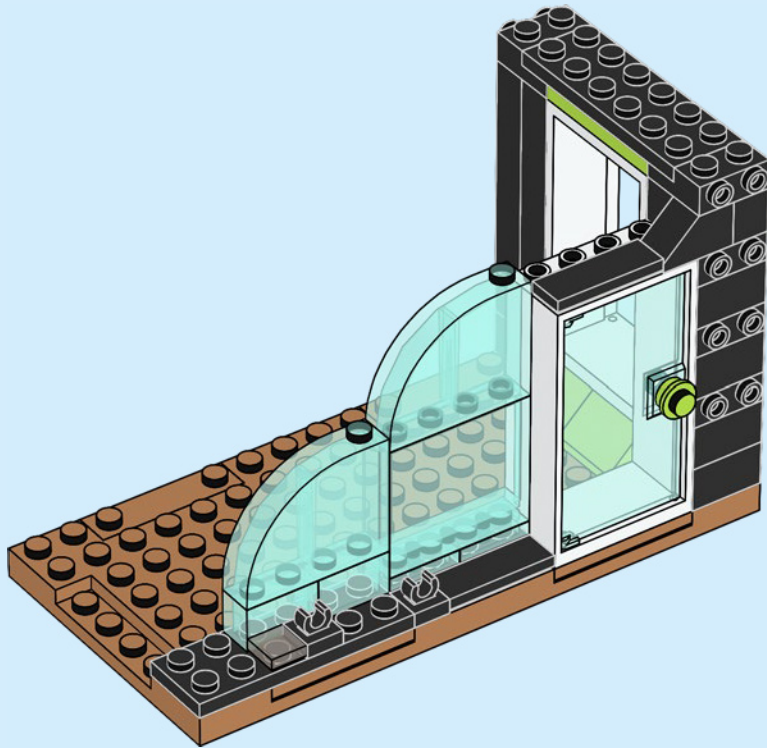

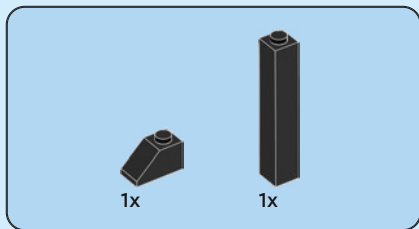

72

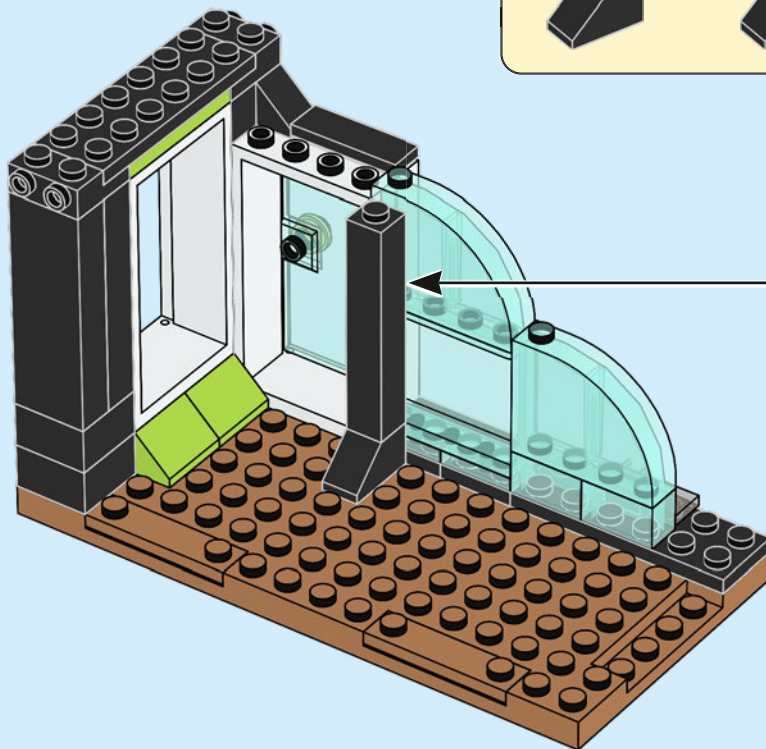
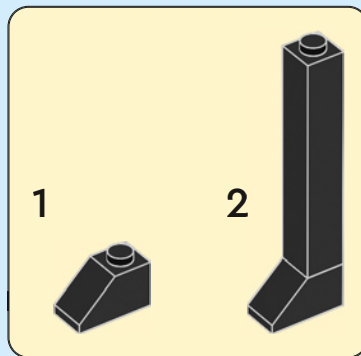

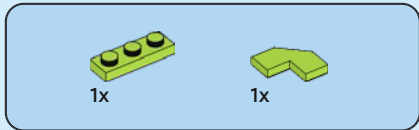

73

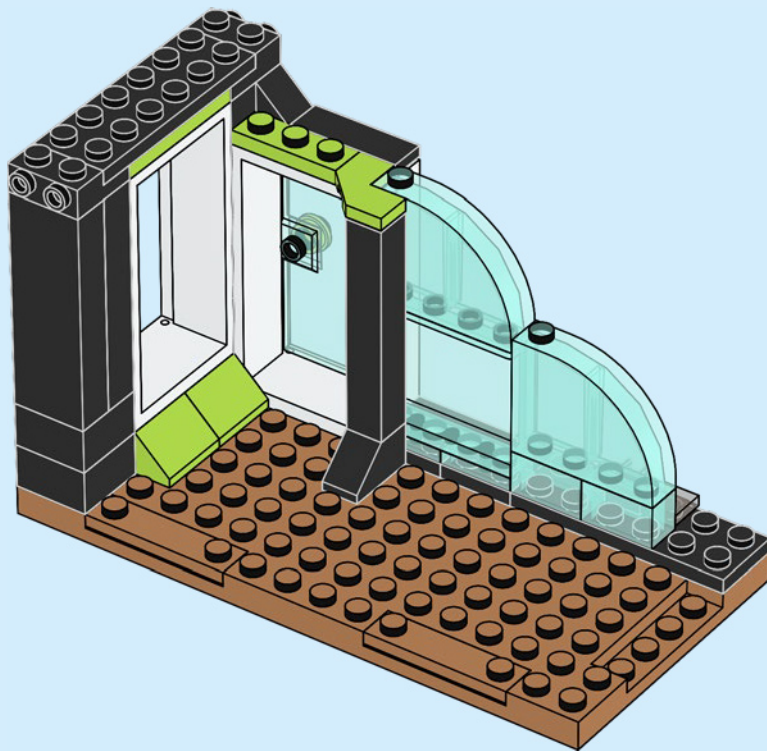

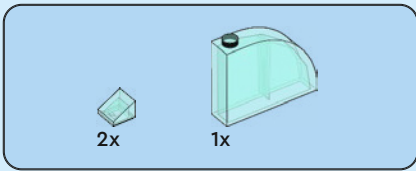

74

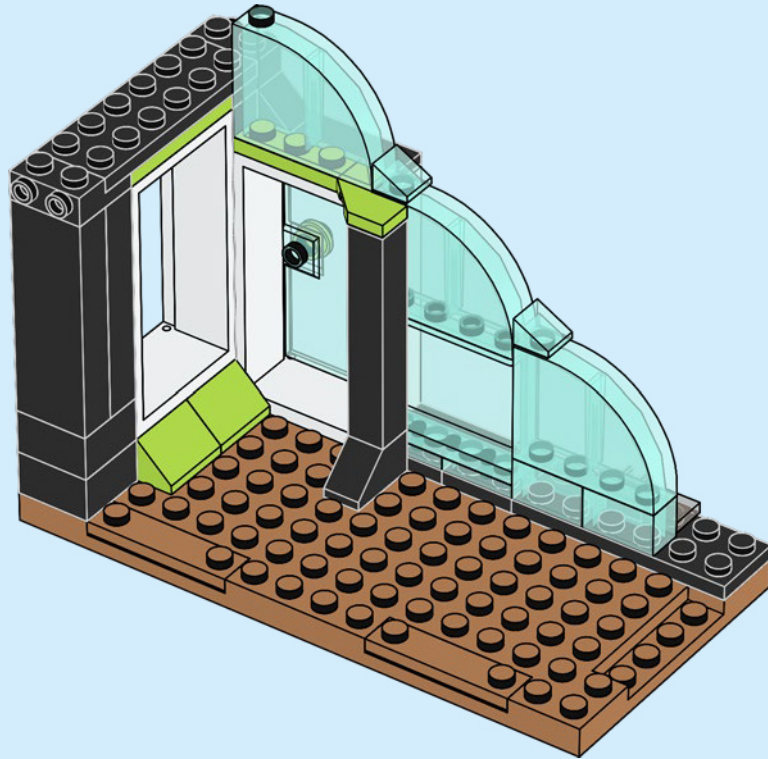

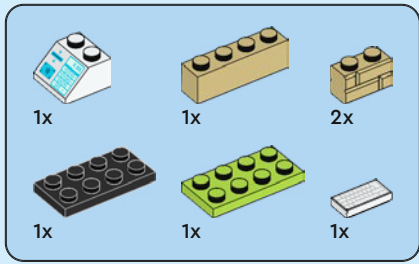

75

1

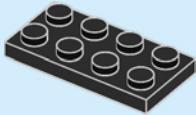

2

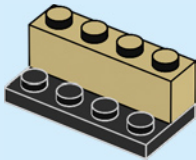

3

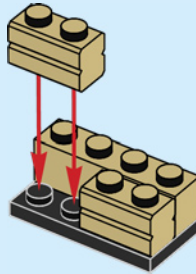

4

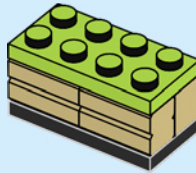

5



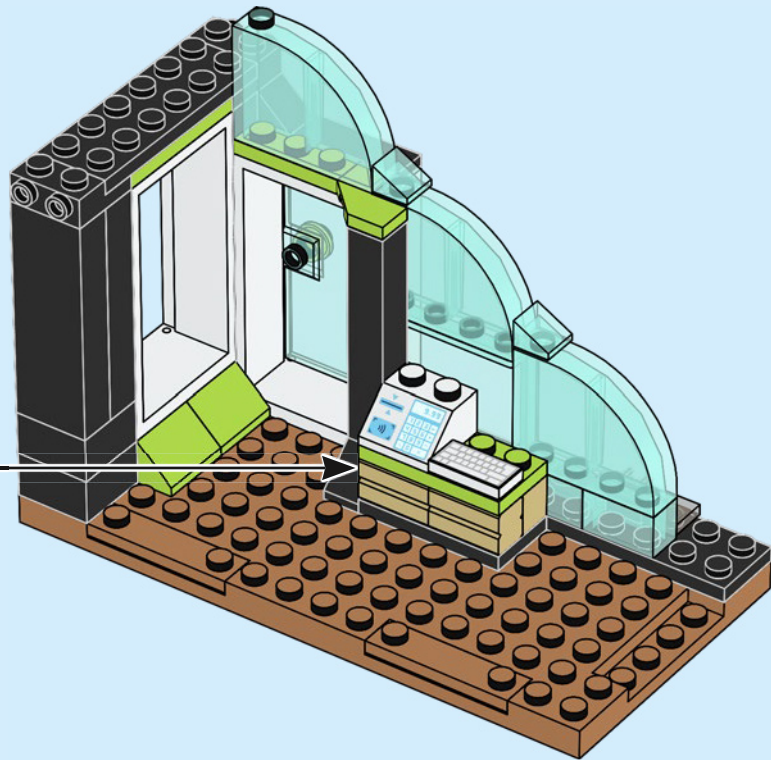



2x

76

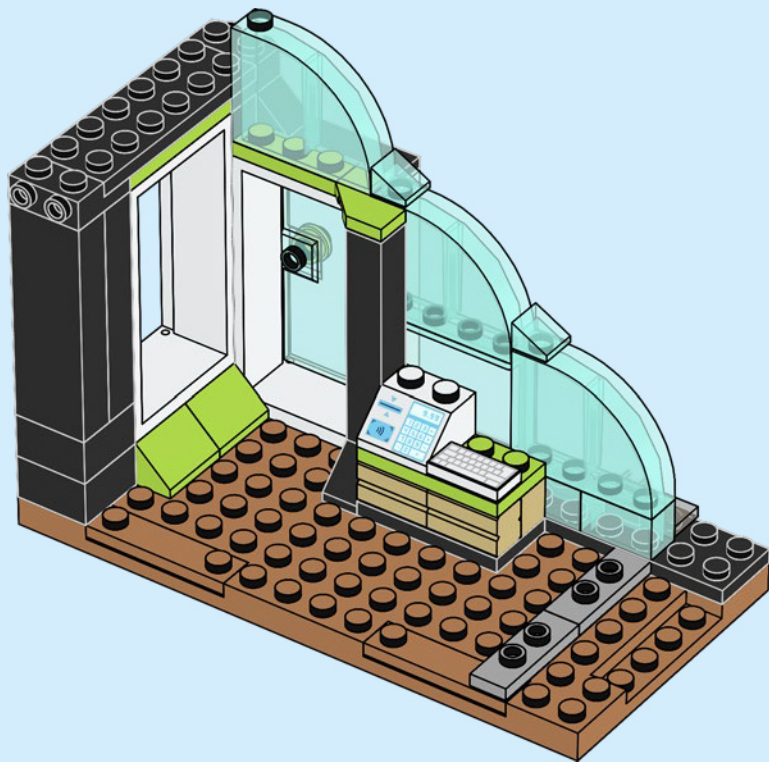



2x

77

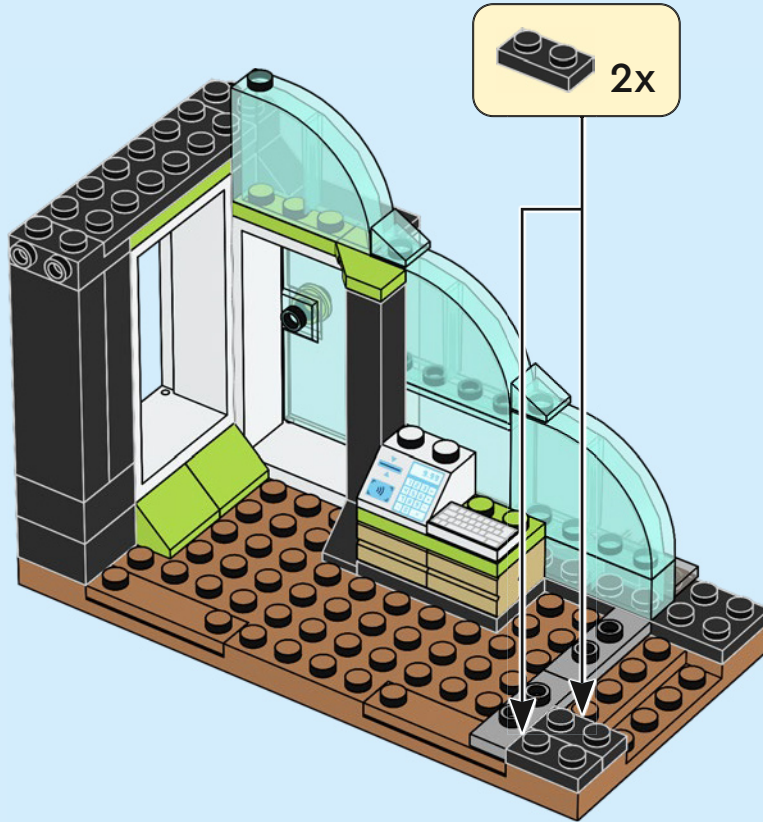



2x

78

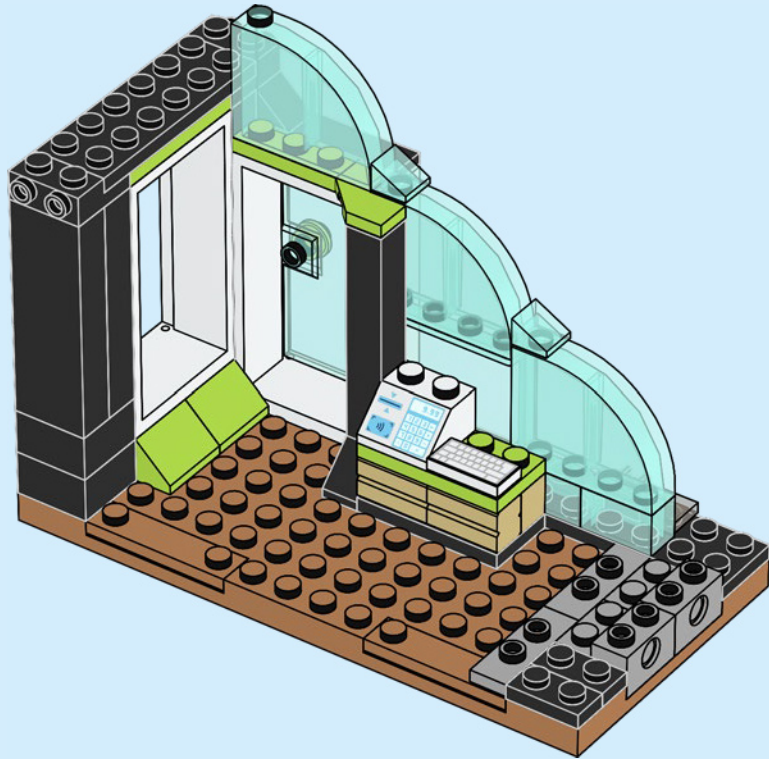

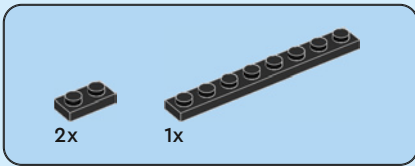

79

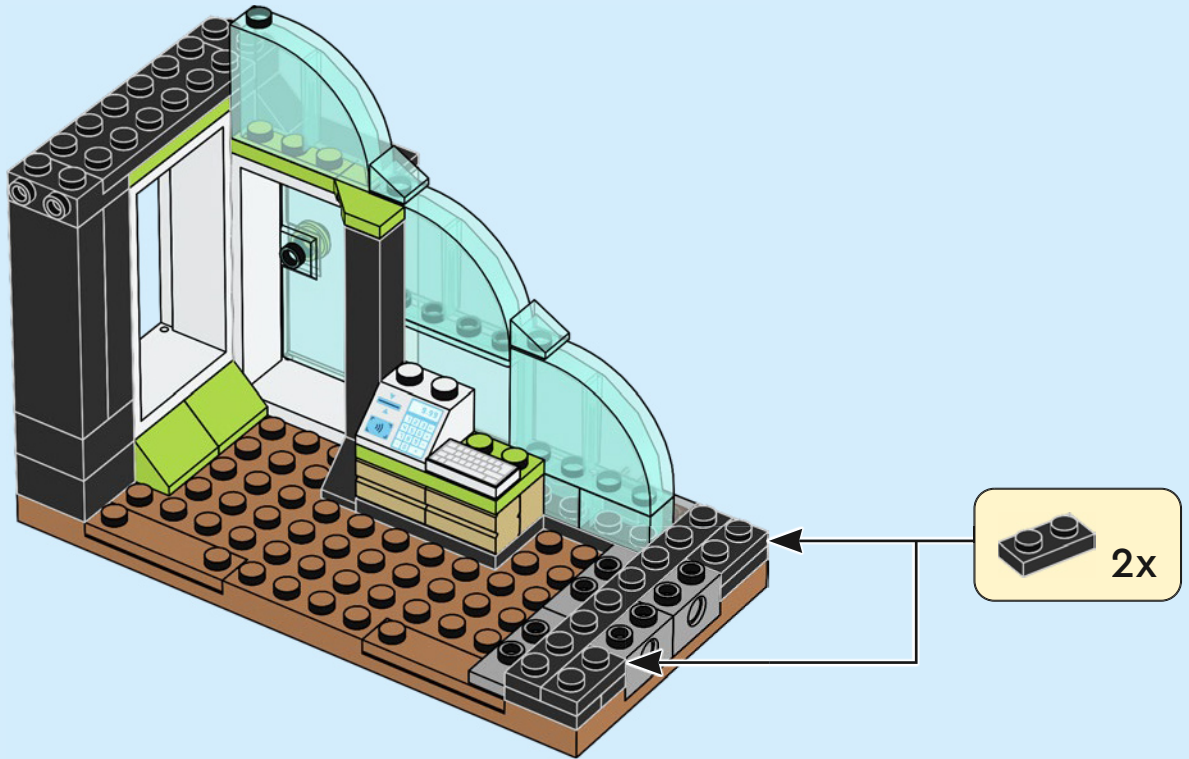

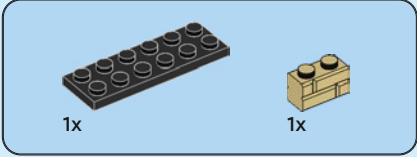
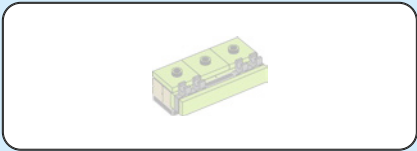

1x

1x

80

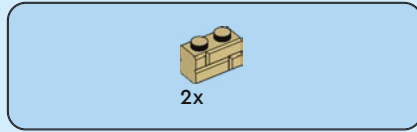
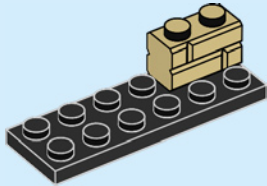

2x

81

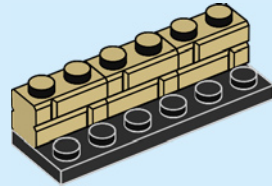



82

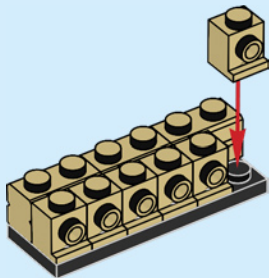

83

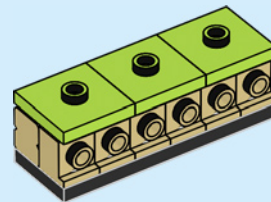



2x

84

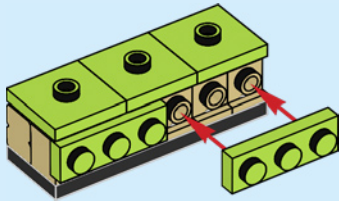

1x



2x

85

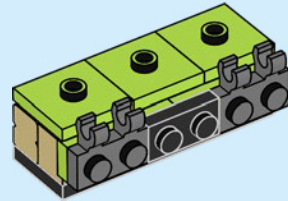

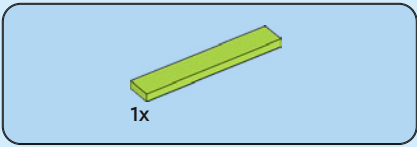

86

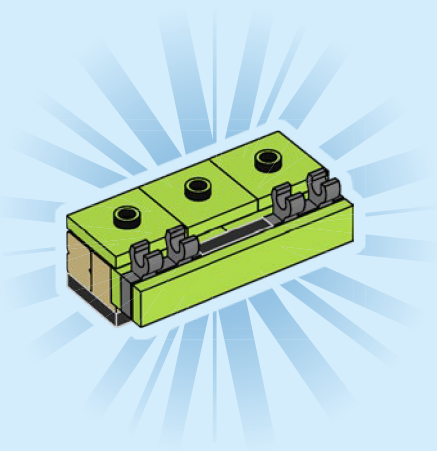

87

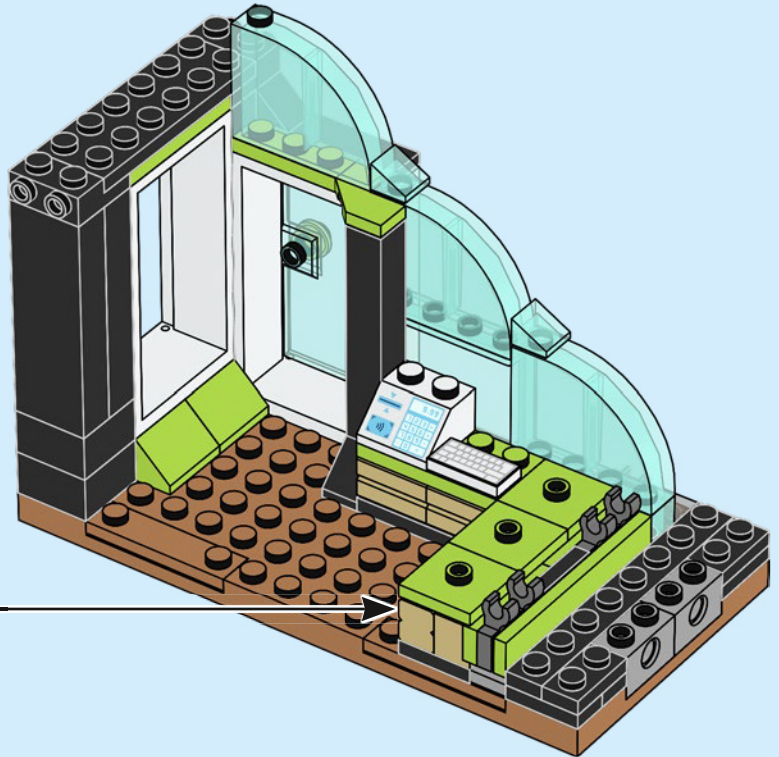

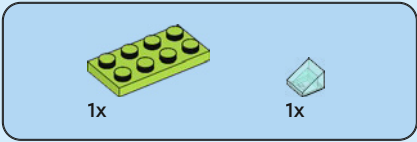

88

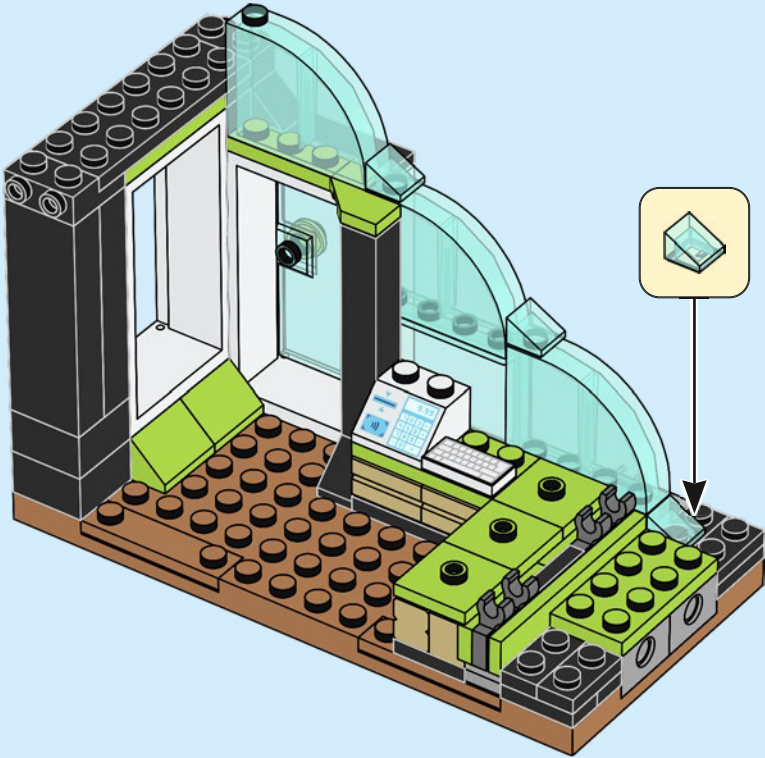



2x

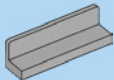

1x

89

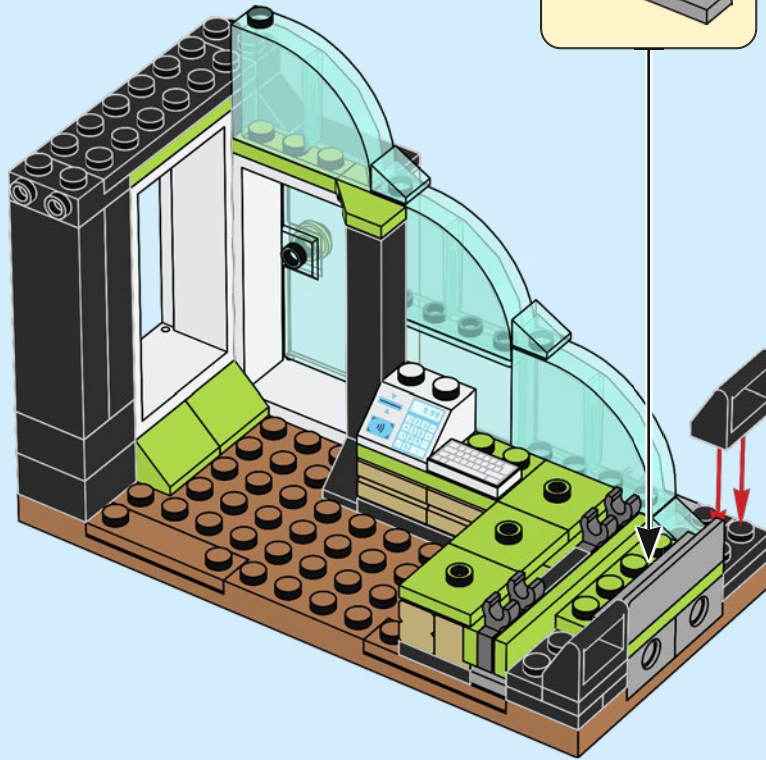
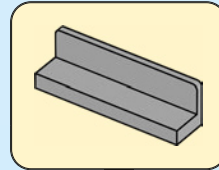

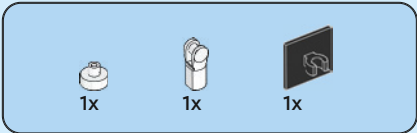

90

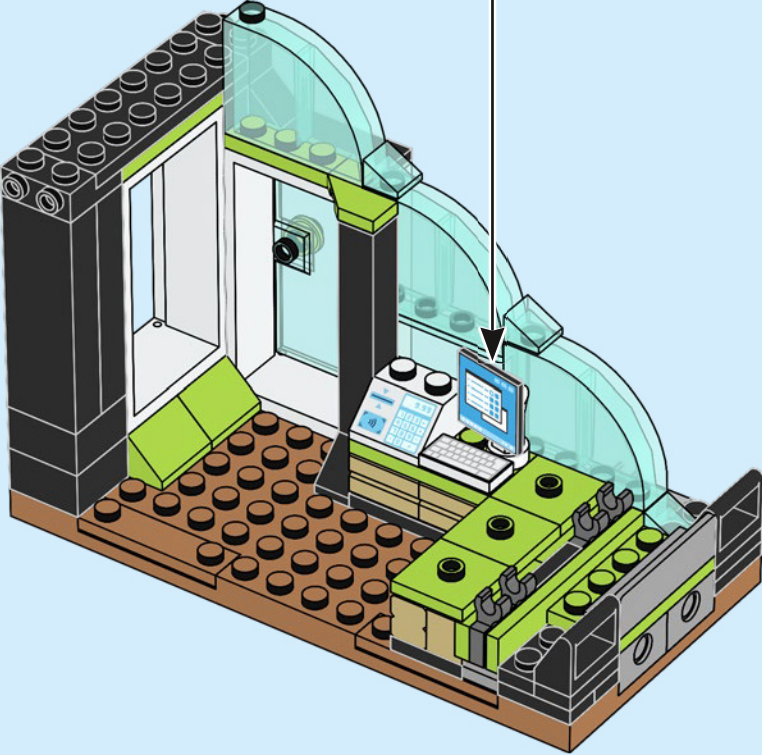
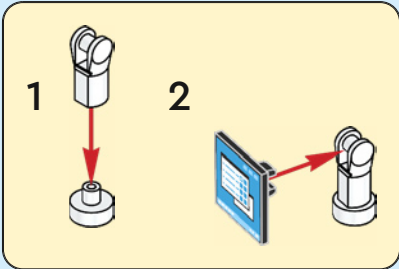



1x



1x

91

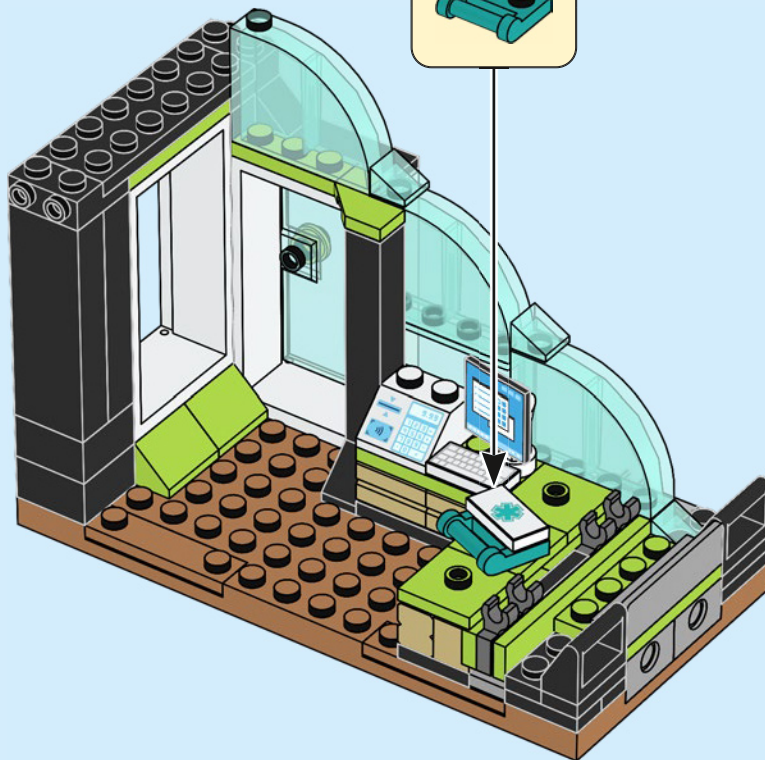
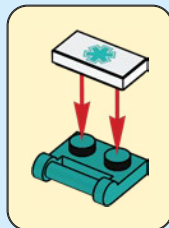

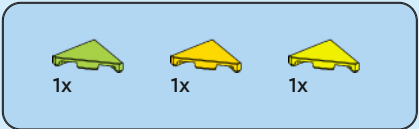

92

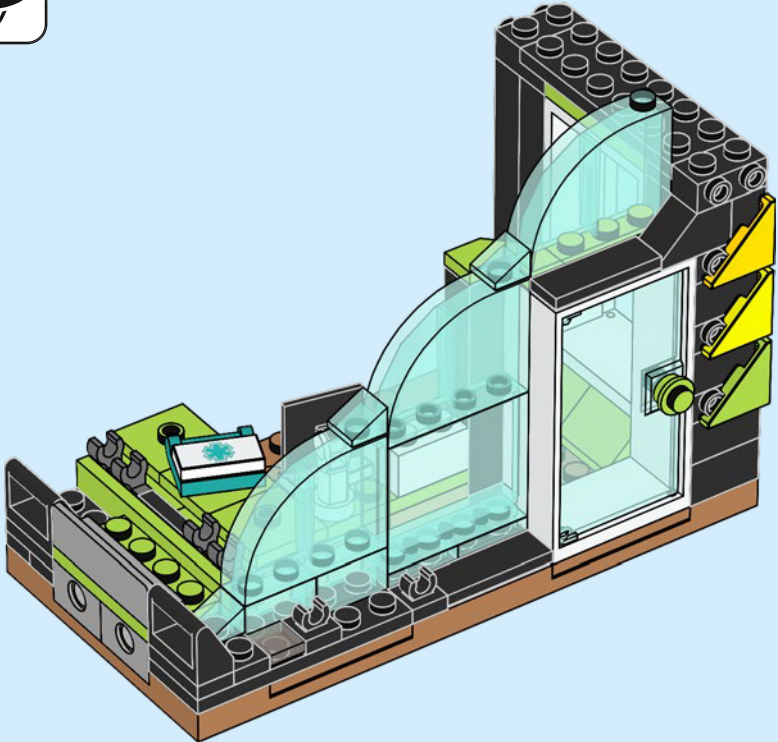



1x



3x

93

1

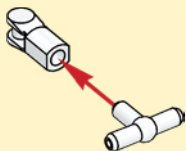

2

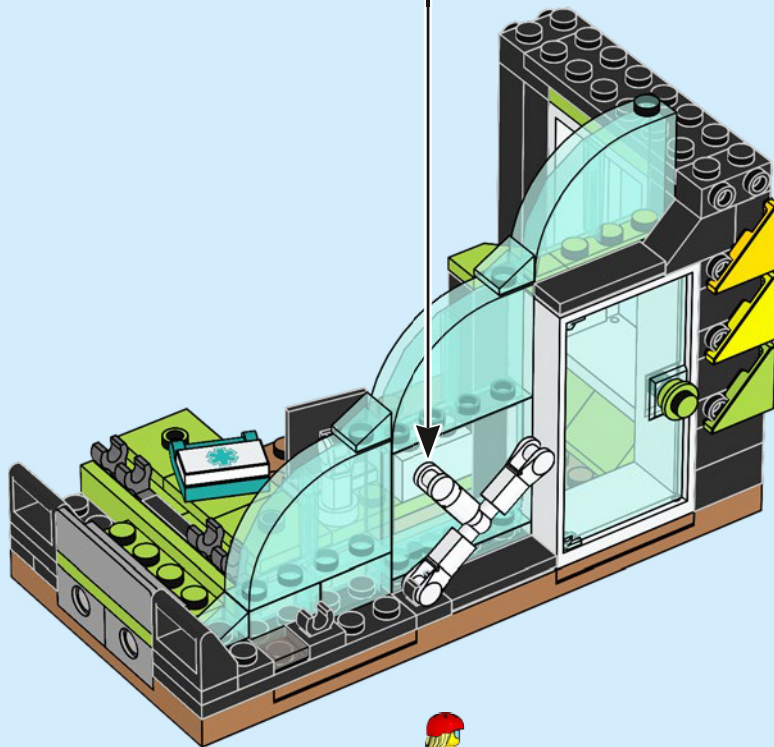
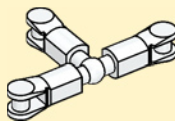



1x



1x



1x

94

1

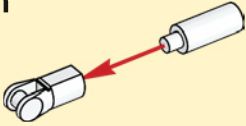

2

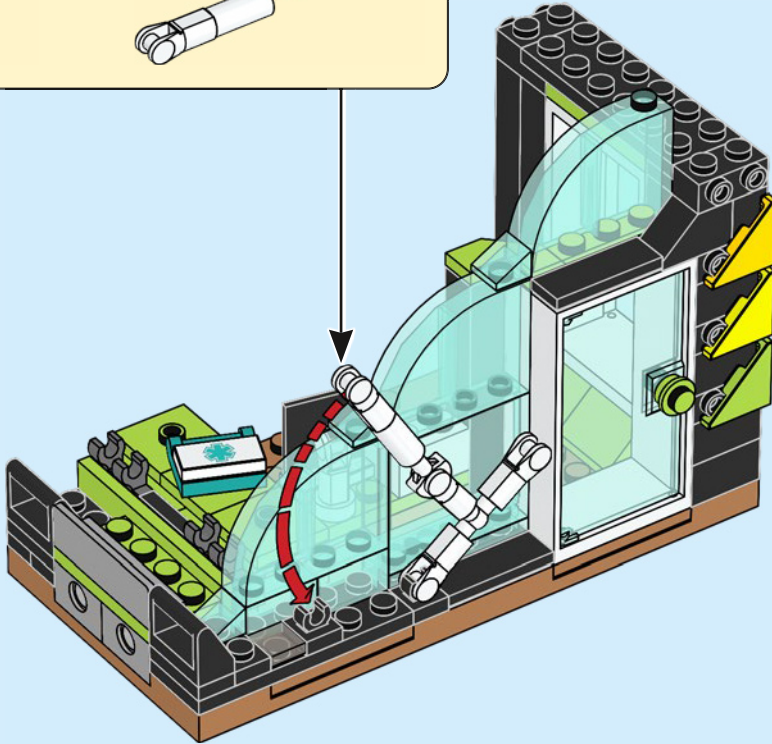
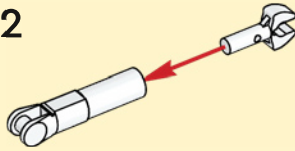

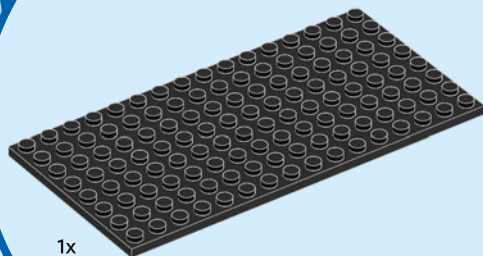
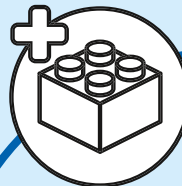

1x



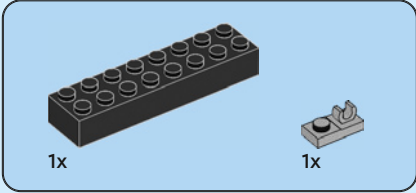
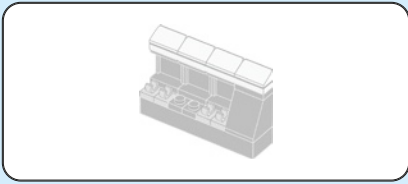

95

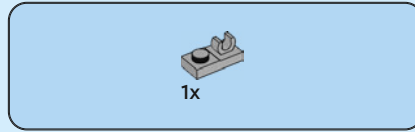
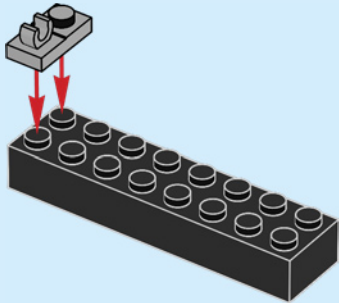

96

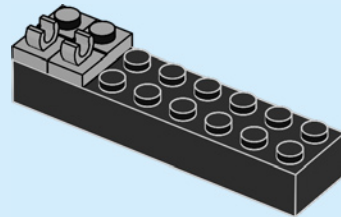



2x

97

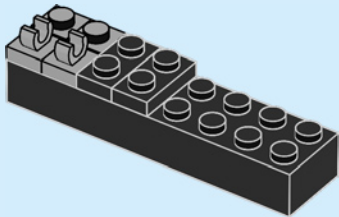

2x

98

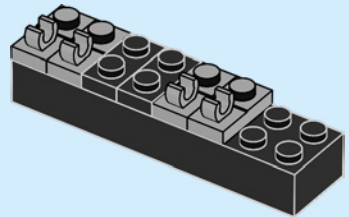

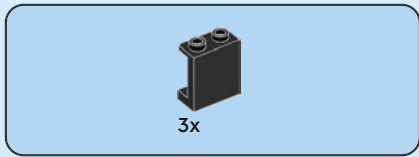

99

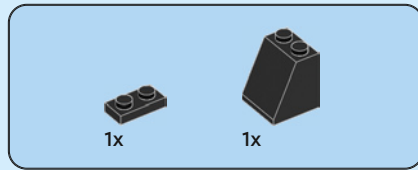
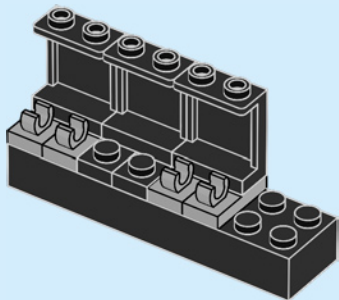

100

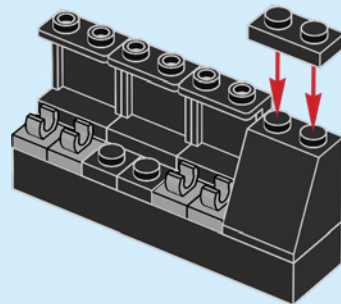

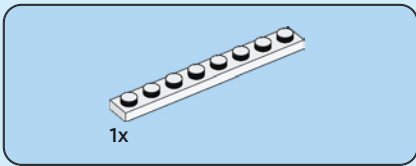

101

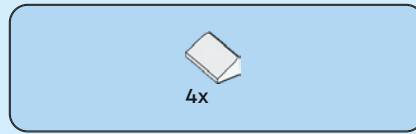
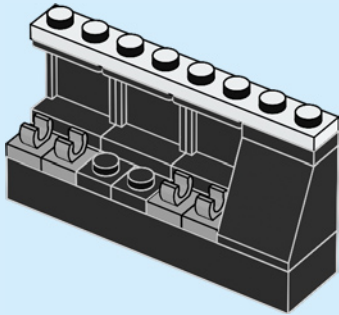

102

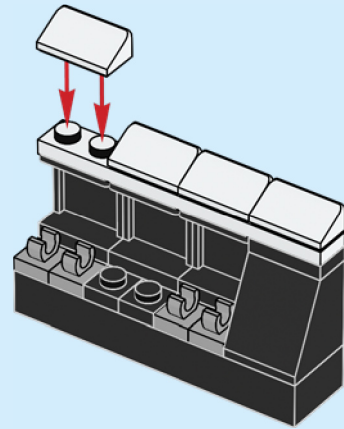

103

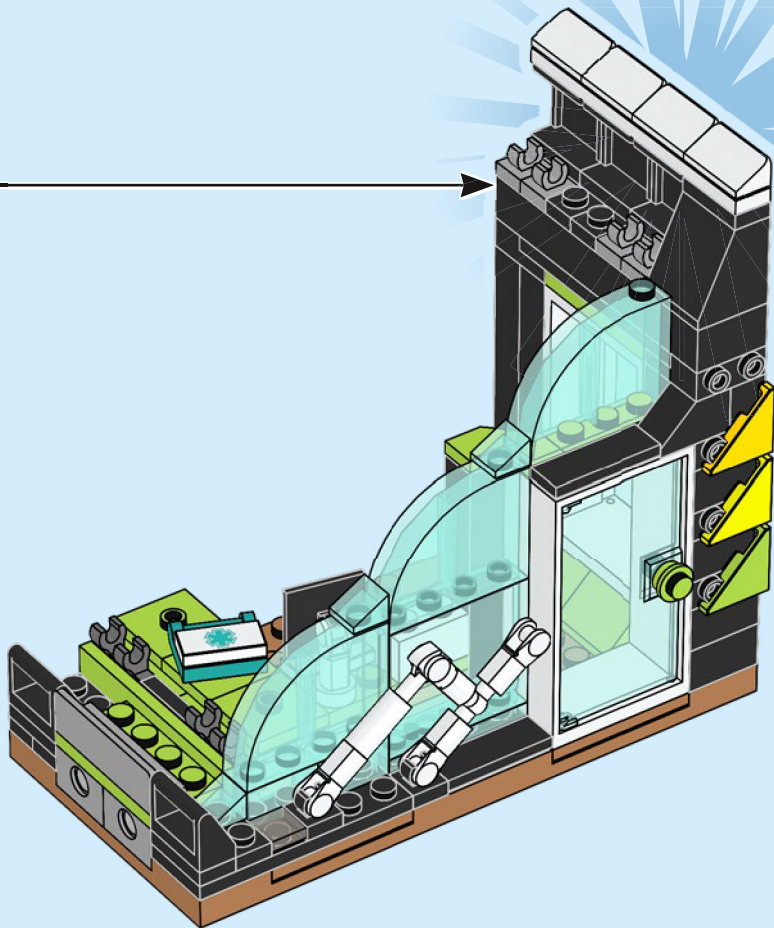



2x

104

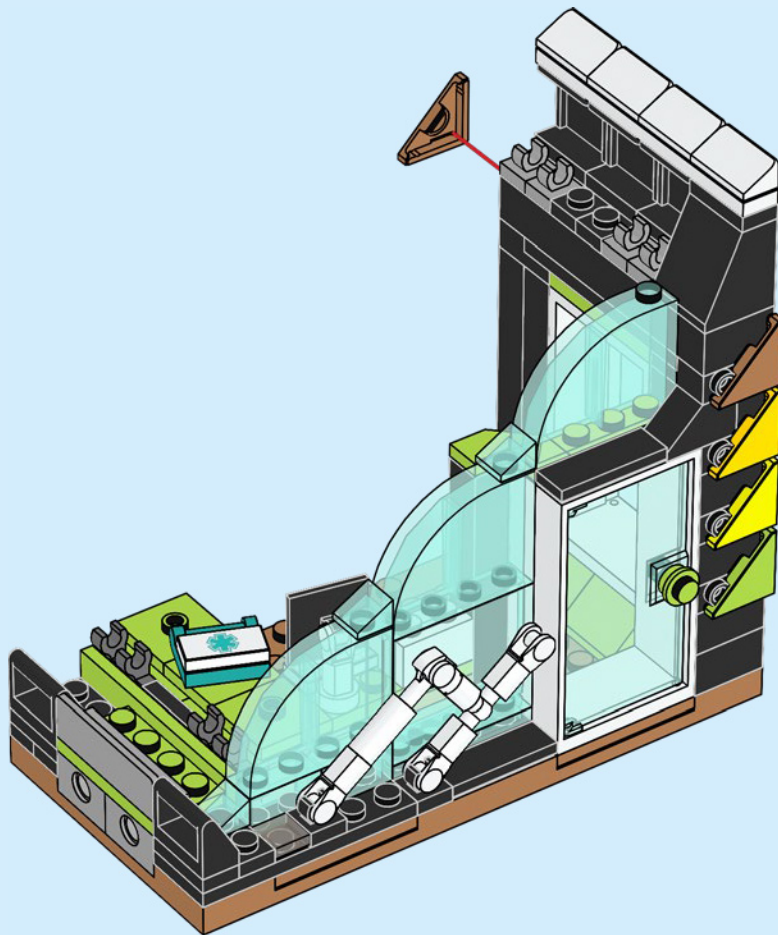

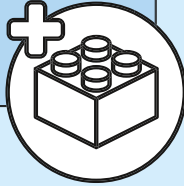
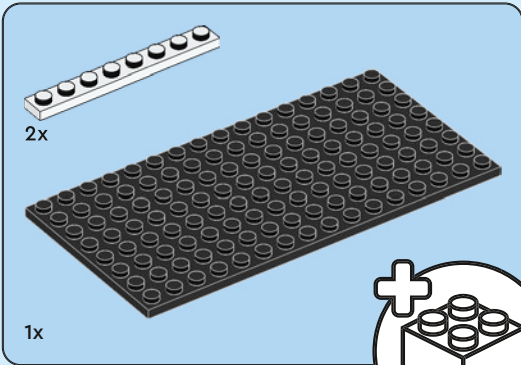
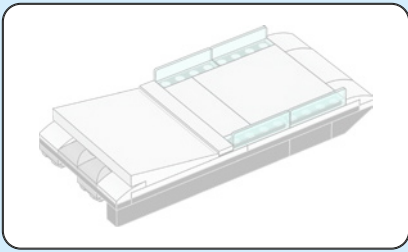

105

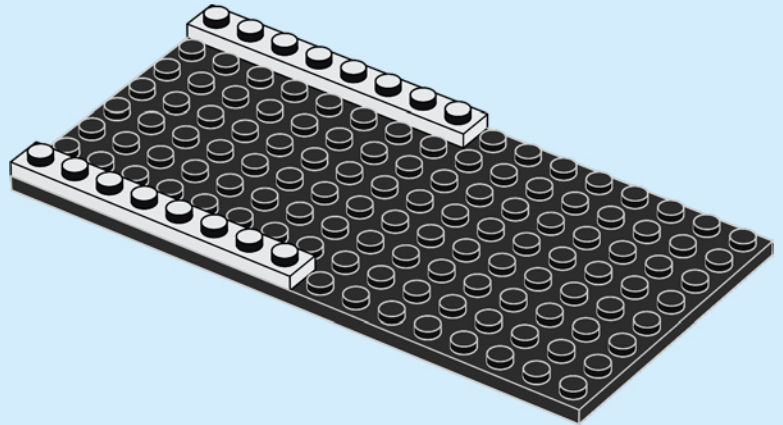

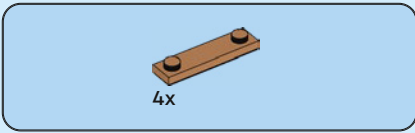

106

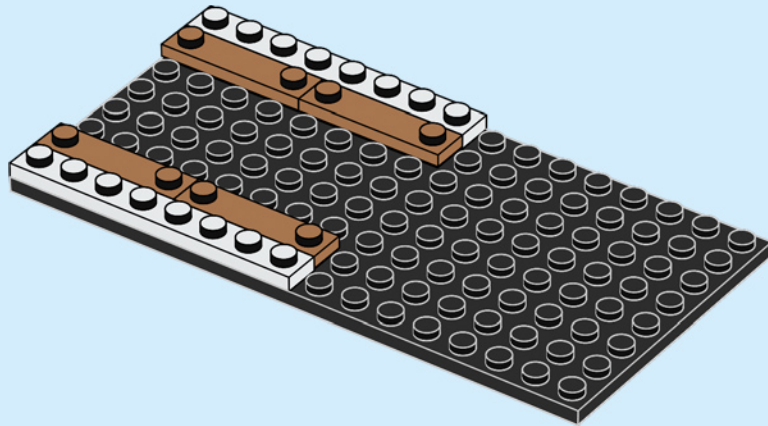

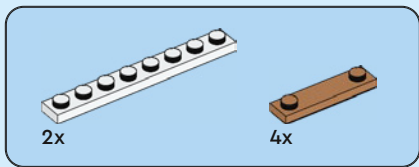

107

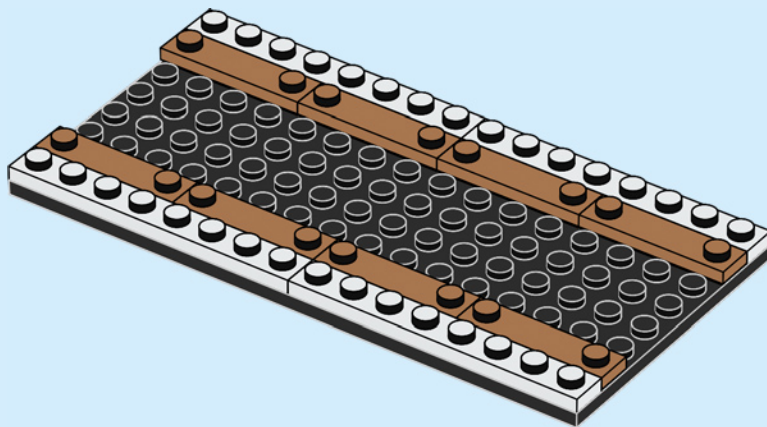

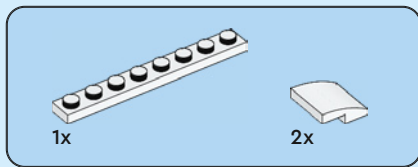

108

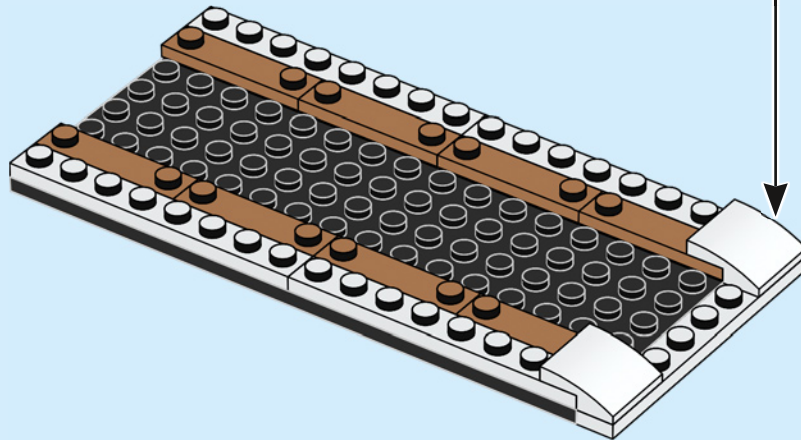
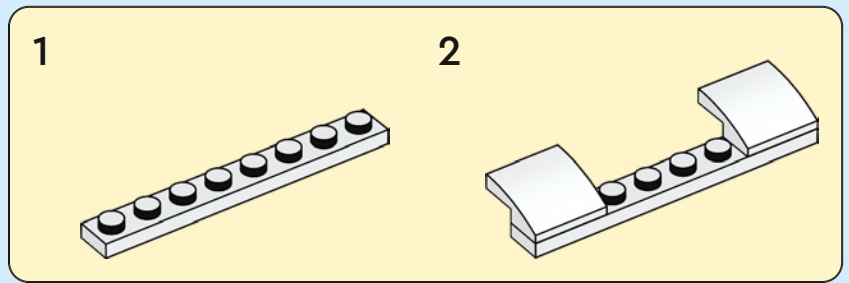

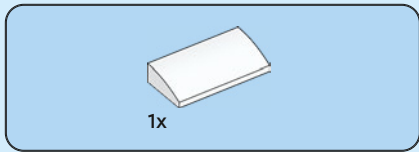

109

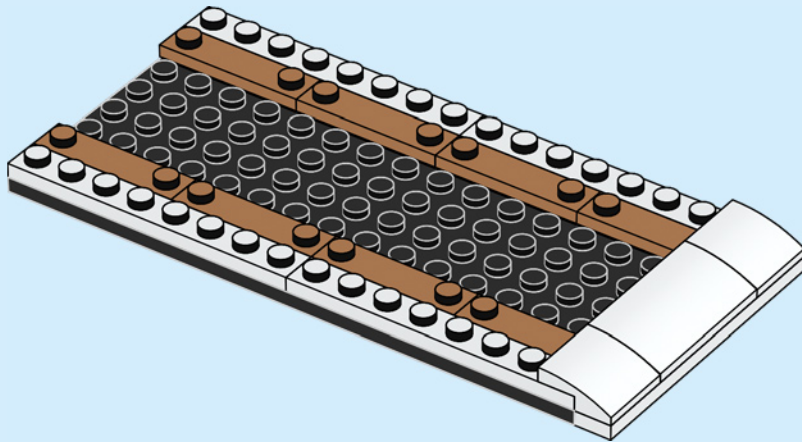

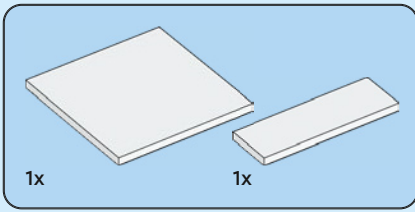

110

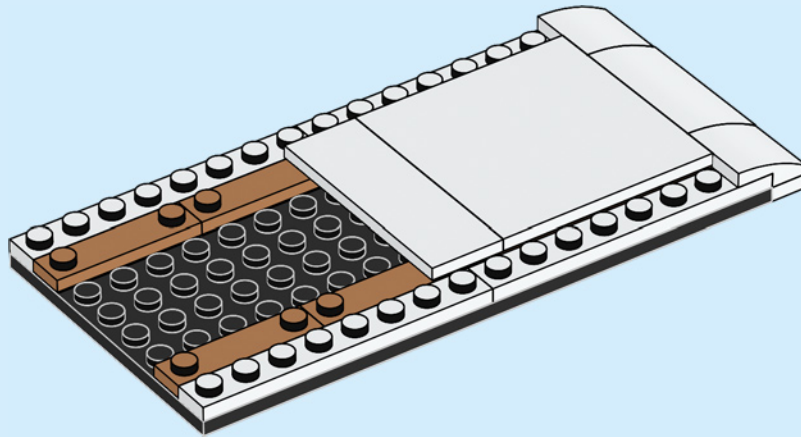

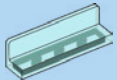

4x

111

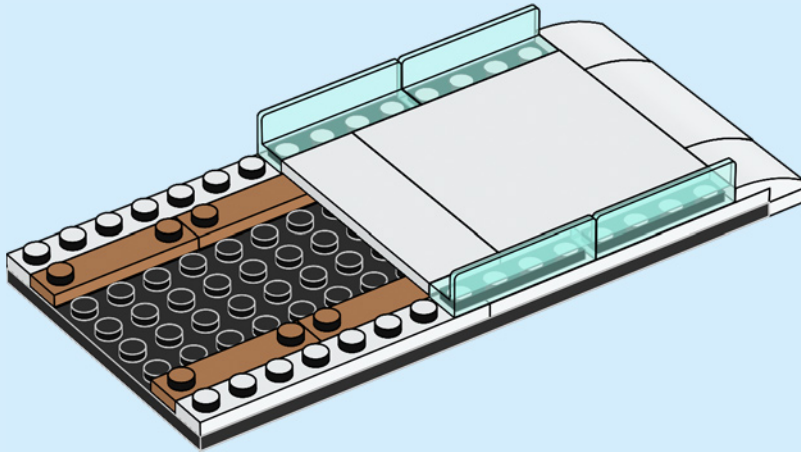

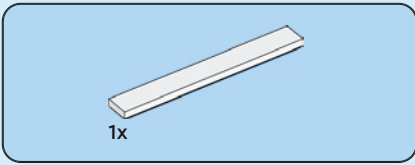

112

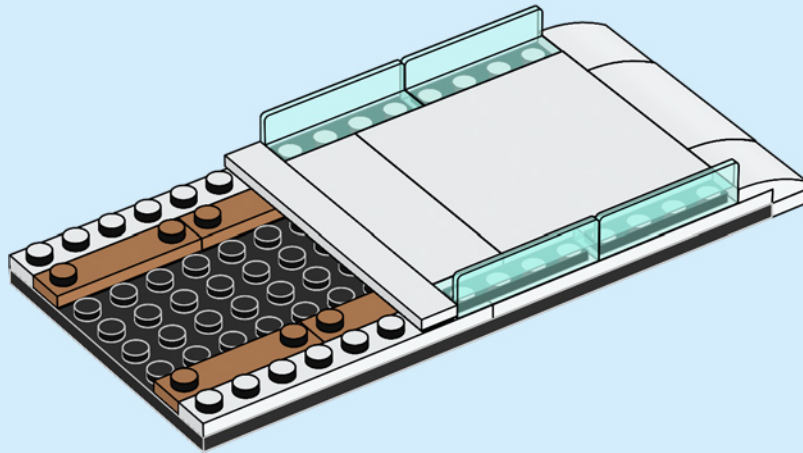

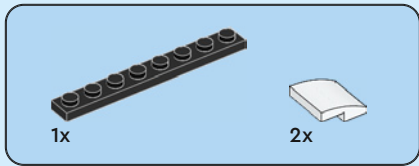

113

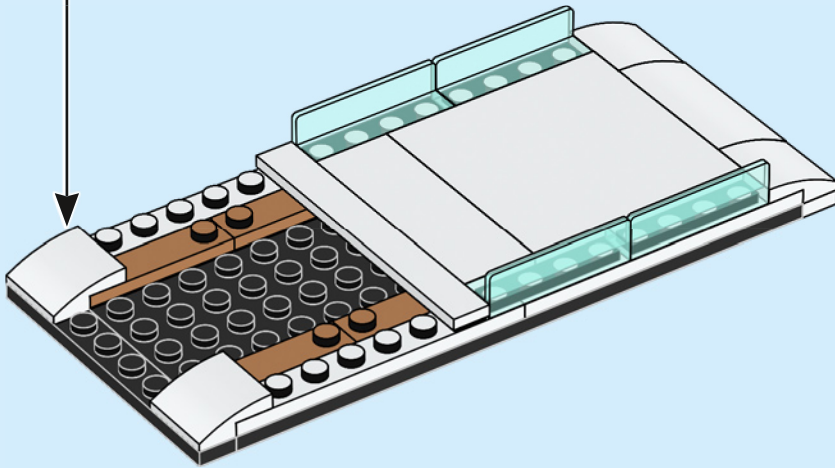
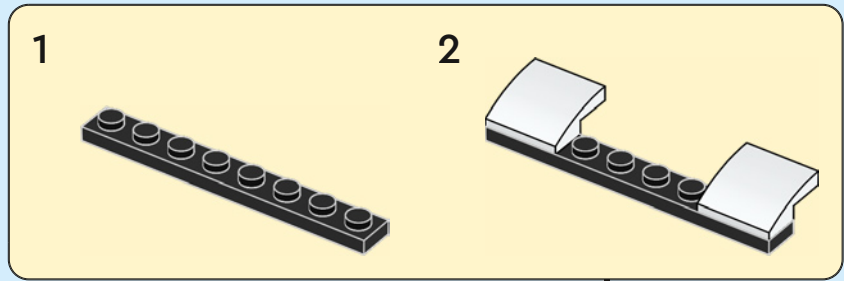



2x

114

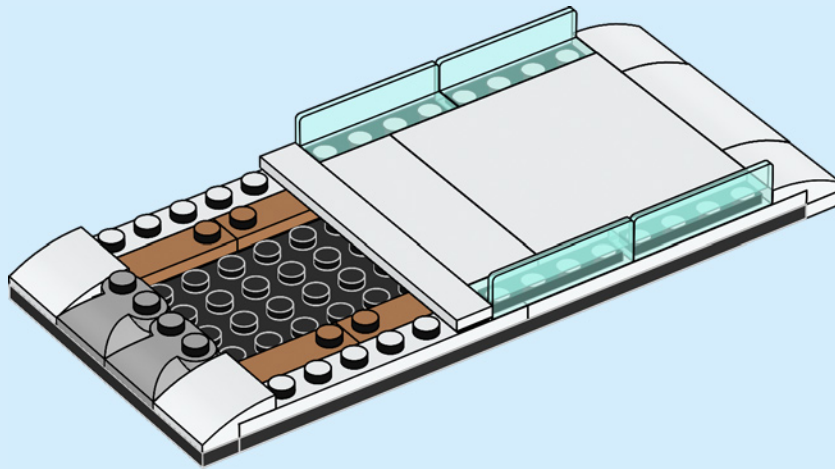

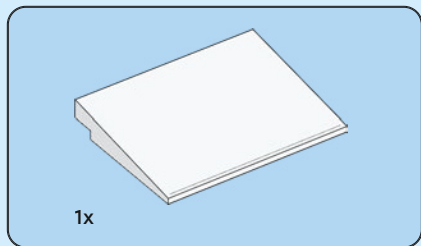

115

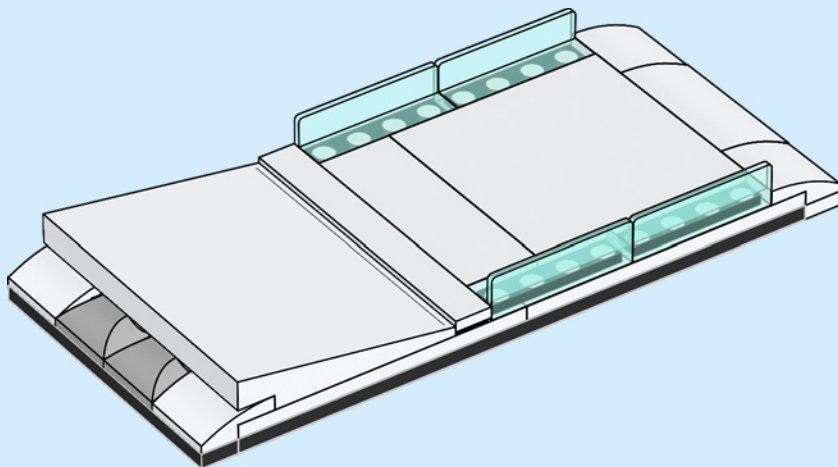

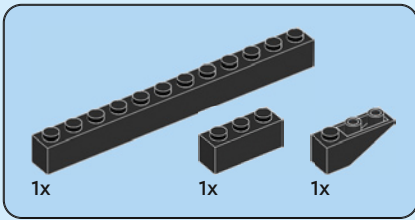

116

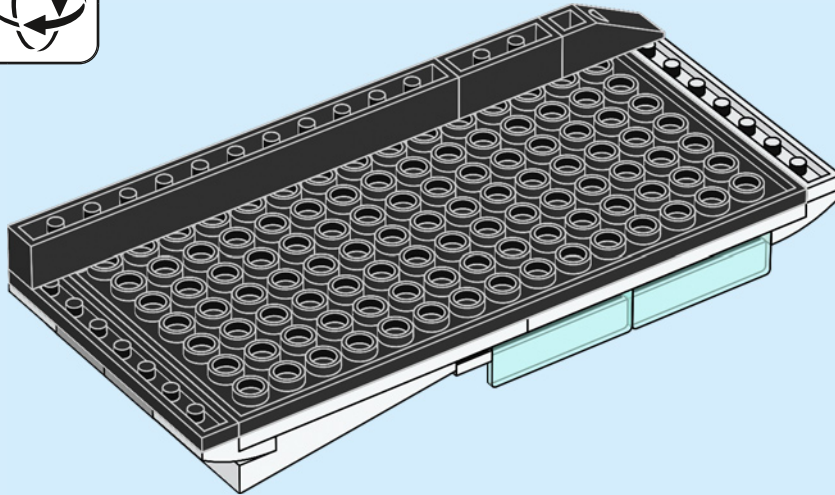

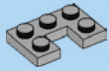

2x

117

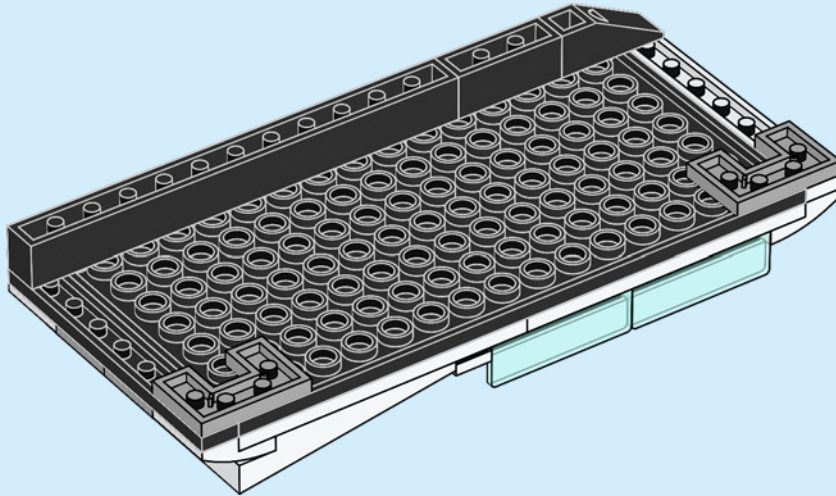



2x

118

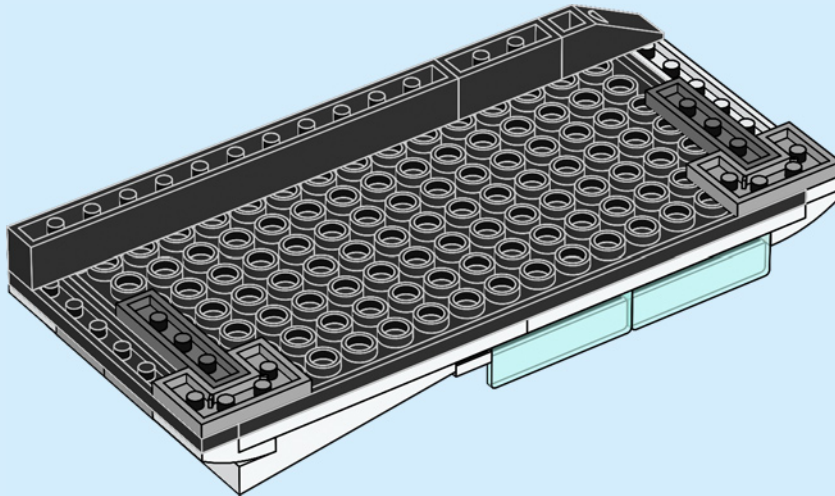



4x

120

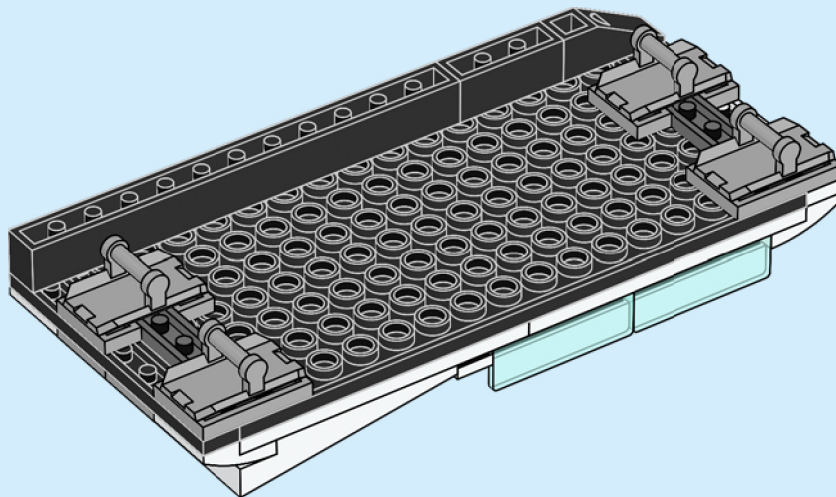

121

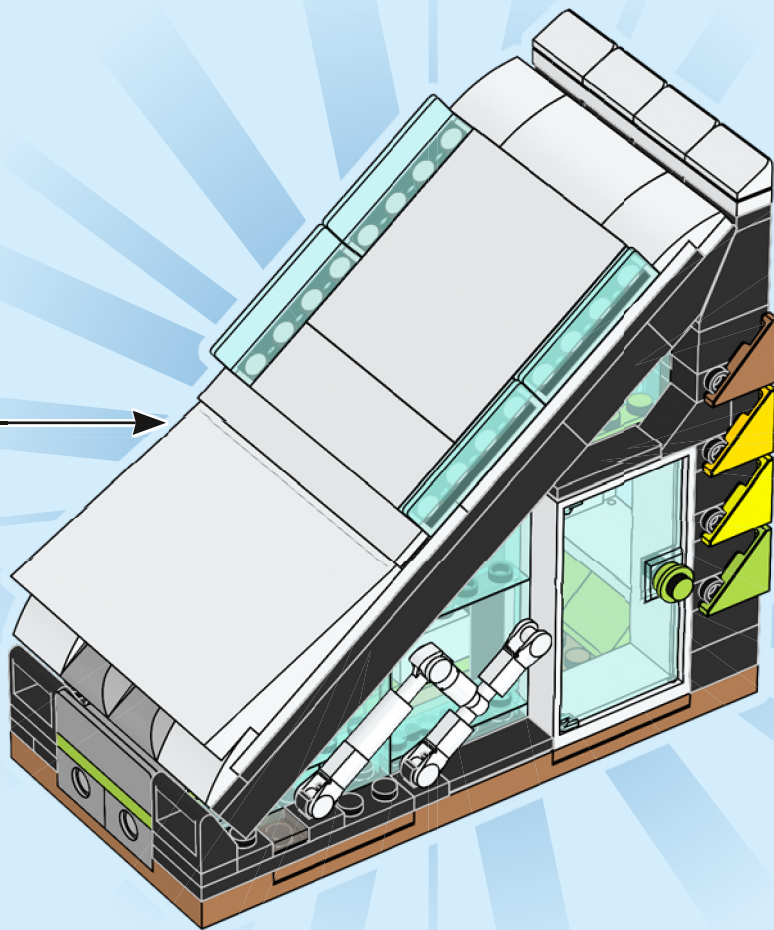

122

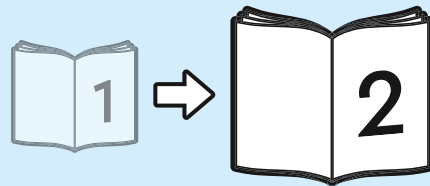
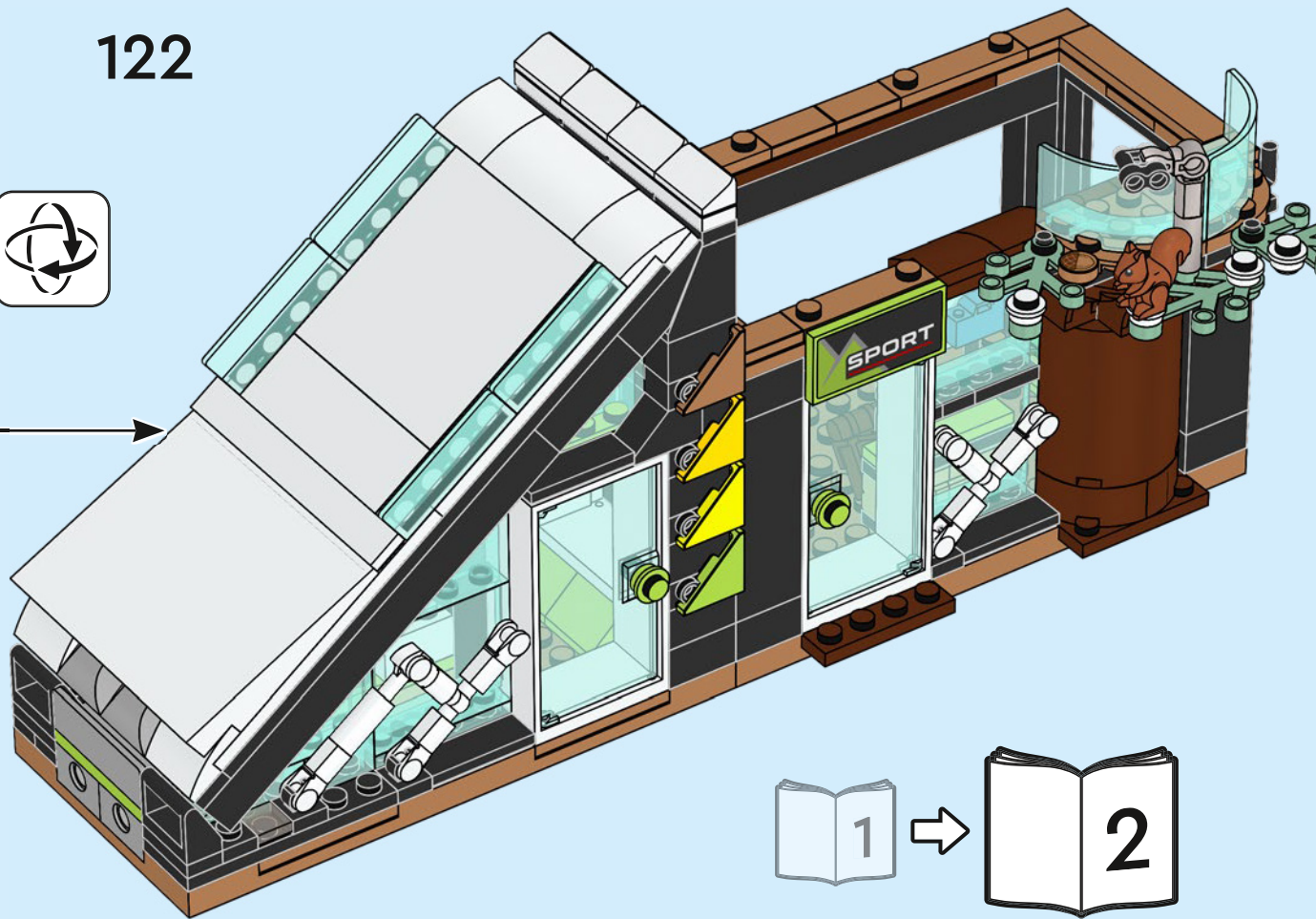
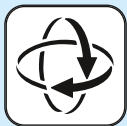

YOU COULD **WIN**



Scan this QR code or go to **LEGO.COM/PRODUCTFEEDBACK** and give us your short feedback about this LEGO® set for a chance to win a cool LEGO prize.

Terms and Conditions apply*

EN: YOU COULD WIN. Terms and Conditions apply* **DE: Du könntest GEWINNEN.** Es gelten die Teilnahmebedingungen* **FR: Tu pourrais GAGNER.** Des conditions s'appliquent* **IT: Potresti VINCERE tu.** Termini e condizioni sono applicabili* **ES: Puedes GANAR.** Aplican términos y condiciones* **PT: Poderá GANHAR.** Aplicam-se termos e condições* **ZH: 轻松获奖. 条款和条件适用*** **PL: Szansa na WYGRANĄ.** Obowiązują warunki korzystania* **CS: Máte šanci VYHRÁT.** Platí všeobecné smluvní podmínky* **SK: Máte šancu VYHRAŤ.** Platia všeobecné zmluvné podmienky* **HU: TE IS NYERHETSZ.** Felhasználási feltételek érvényesek* **RO: Ai putea CÂȘTIGA.** Se aplică termeni și condiții* **BG: Можете да СПЕЧЕЛИТЕ.** Има определени правила и условия* **LV: Tu vari LAIMĒT.** Ir spēkā noteikumi un nosacījumi.* **ET: Sul on võimalus VÕITA.** Kehtivad tingimused* **LT: Jūs galite LAIMĖTI.** Taikomos sąlygos*

*[LEGO.com/productfeedback-terms](https://www.lego.com/productfeedback-terms)