



# Disney

43215



1



FR  
**DONNEZ**  
OU  
**RECYCLEZ**



OU



OU



ASSOCIATION    MAGASIN    DÉCHÈTERIE

Adresses sur [quefairedemesdechets.fr](http://quefairedemesdechets.fr)



[LEGO.com/sustainable-packaging](http://LEGO.com/sustainable-packaging)



# BUILDER



Apple and the Apple logo are trademarks of Apple Inc., registered in the U.S. and other countries and regions. App Store is a service mark of Apple Inc. Google Play and the Google Play logo are trademarks of Google LLC. Tencent and the Tencent logo are trademarks of Tencent Inc.

Q [LEGO.com/devicecheck](https://www.lego.com/devicecheck)

EN Ask parents' permission before going online | DE Eltern um Erlaubnis bitten, bevor du online gehst | FR Demande l'autorisation d'un parent avant d'aller en ligne | IT Chiedi il permesso ai tuoi genitori prima di andare online | ES Pídeles permiso a tus papás antes de conectarte a Internet | PT Peça autorização aos pais antes de acederes online | ZH 上网前应先征得父母的同意 | PL Poproś rodziców o zgodę, zanim wejdiesz do Internetu | CS Než půjdeš na internet, požádej rodiče o svolení | SK Skôr než pôjdeš na internet, vypýtaj si povolenie od rodičov | HU Kérj szülői engedélyt, mielőtt online csatlakoznál! | RO Cere permisiunea părinților înainte de a te conecta online | BG Поискайте разрешение от родител, преди да влезете онлайн | LV Pirms došanās tiešsaistē palūdz atļauju vecākiem | ET Enne Interneti kasutamist küsi vanematelt luba | LT Prieš prisijungdami prie interneto, atsklauskite tėvų

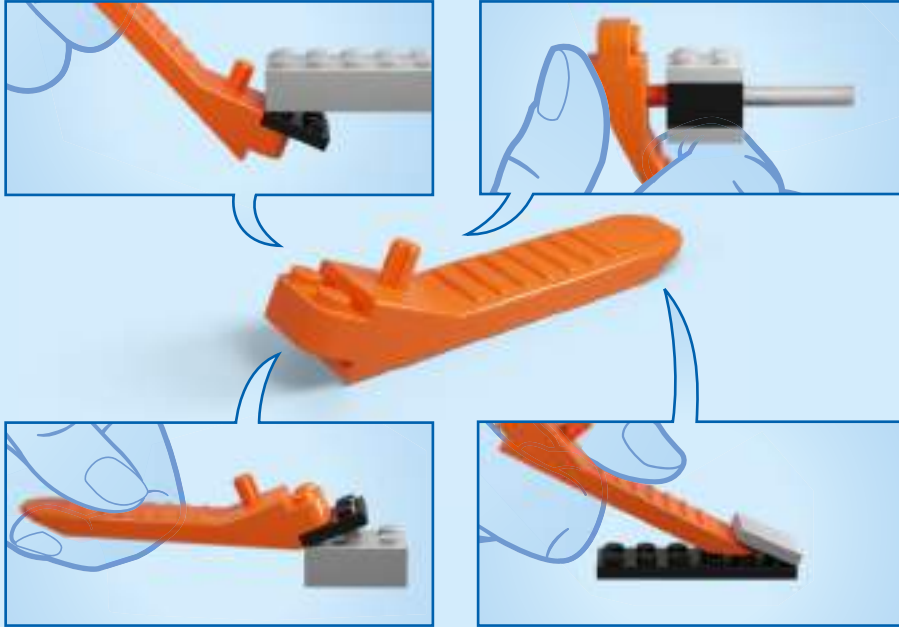



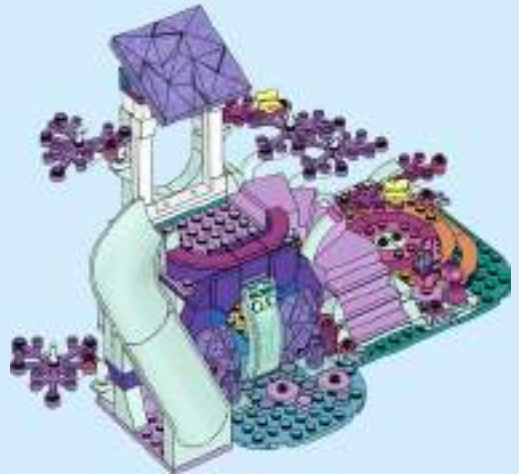
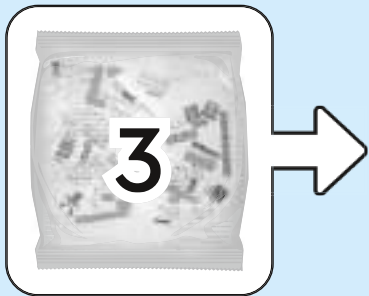
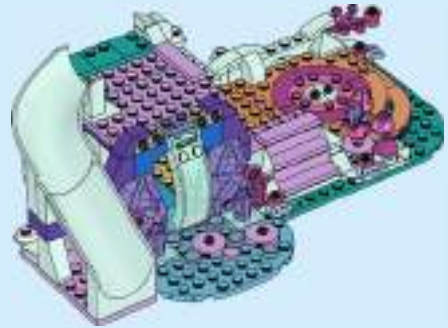
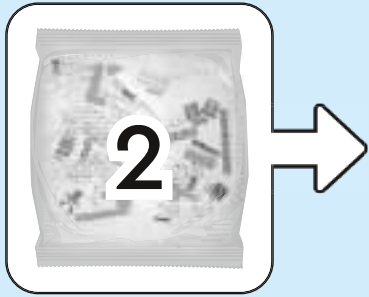
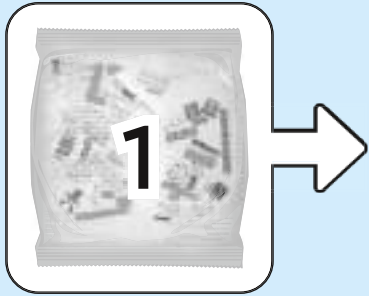

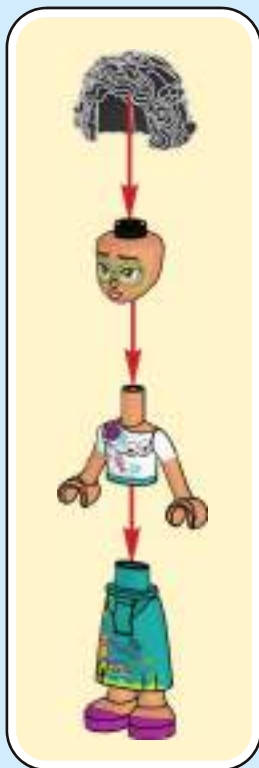

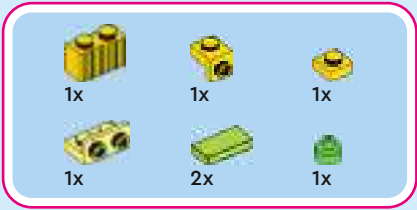

1



2



3

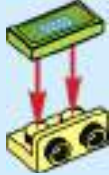

4



5



6



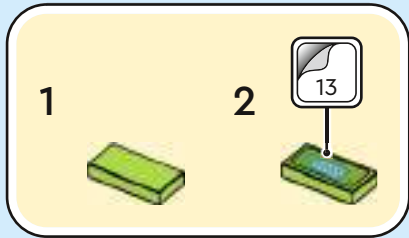

7





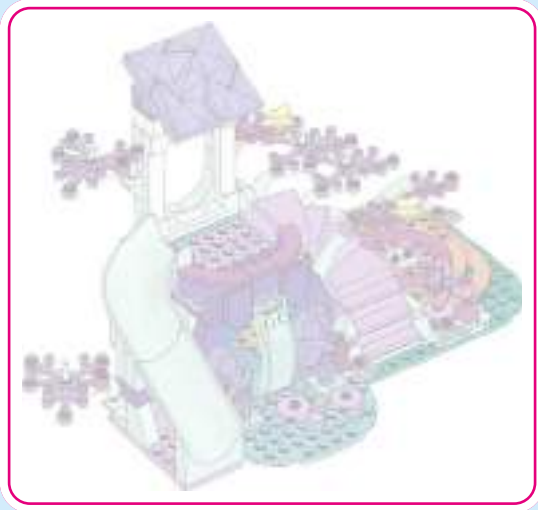

1



2

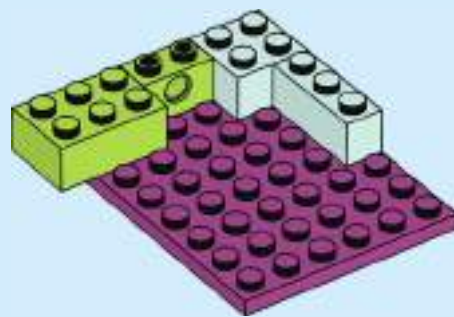



3

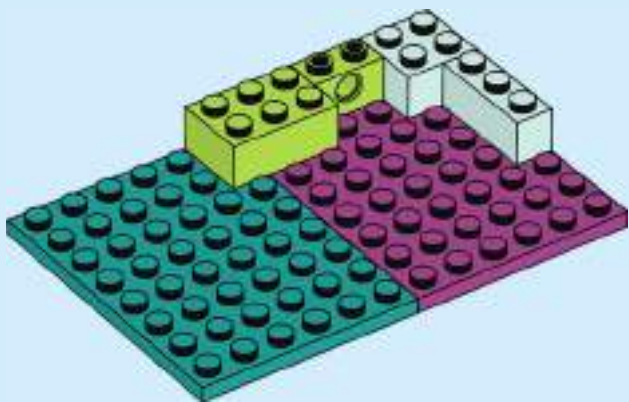

4

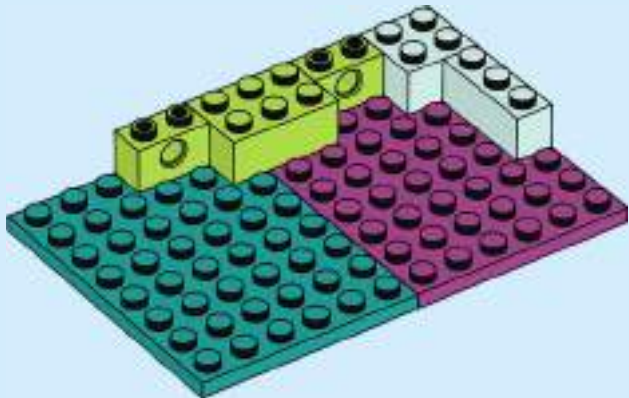

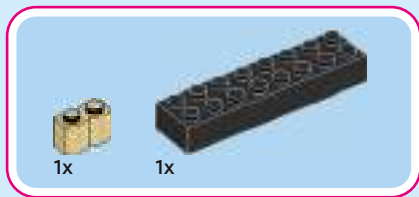

5

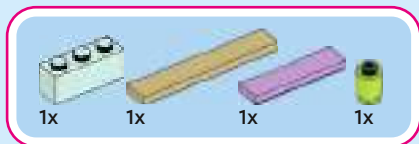
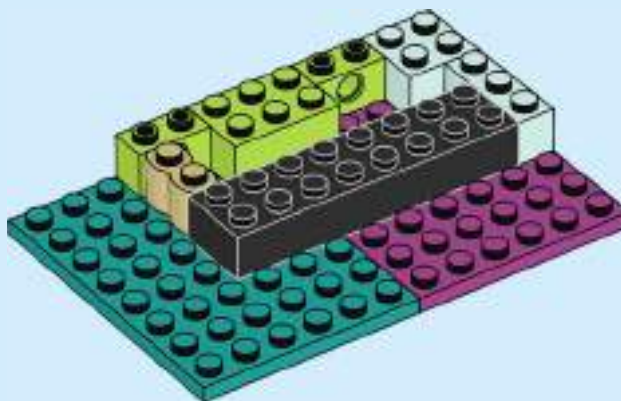

6

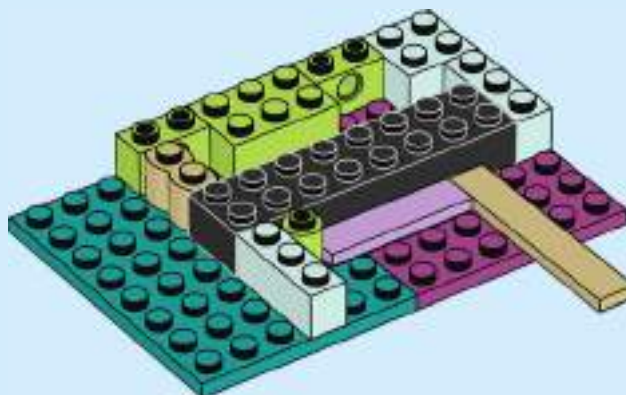

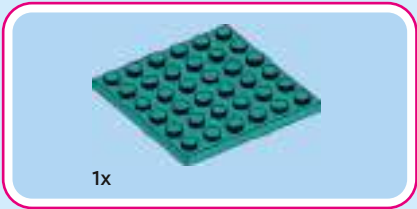

1x

7

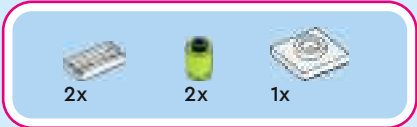
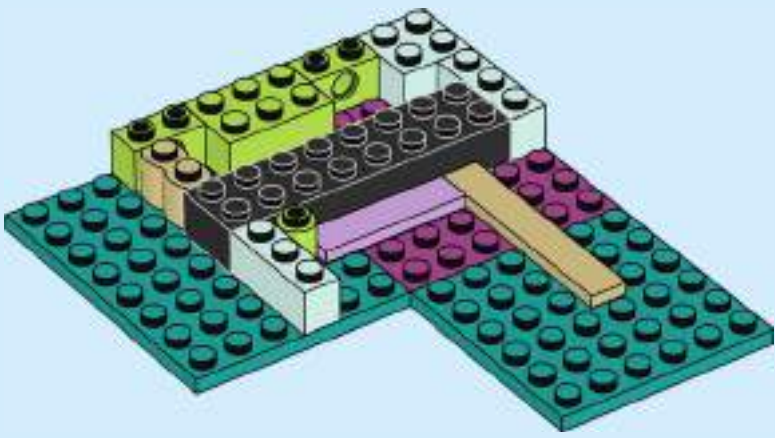

2x

2x

1x

8

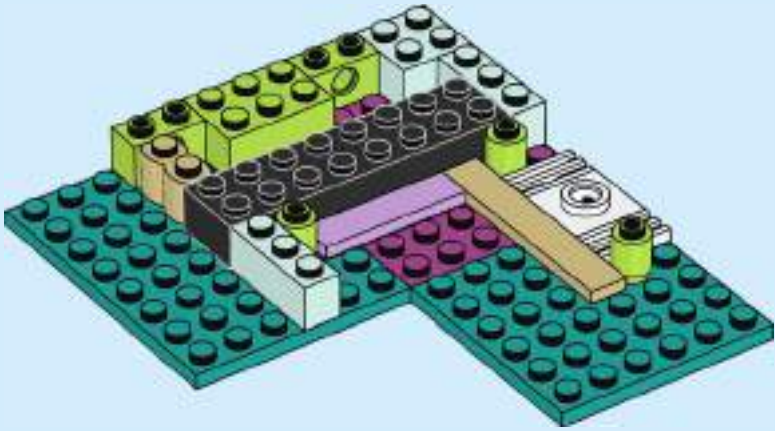

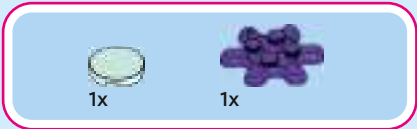

9

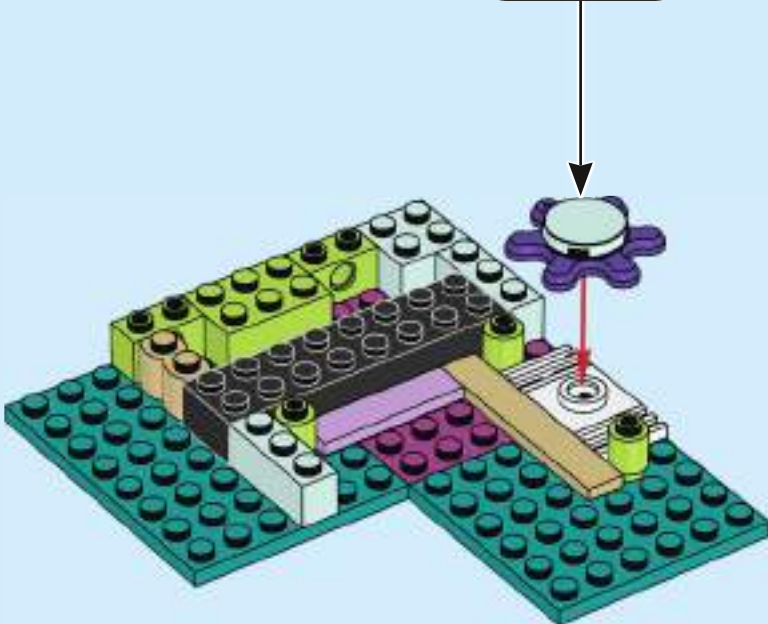
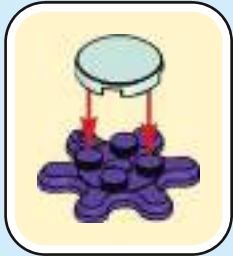

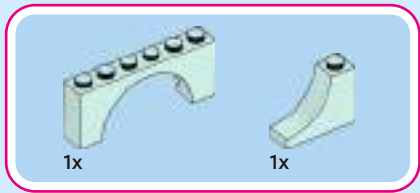

10

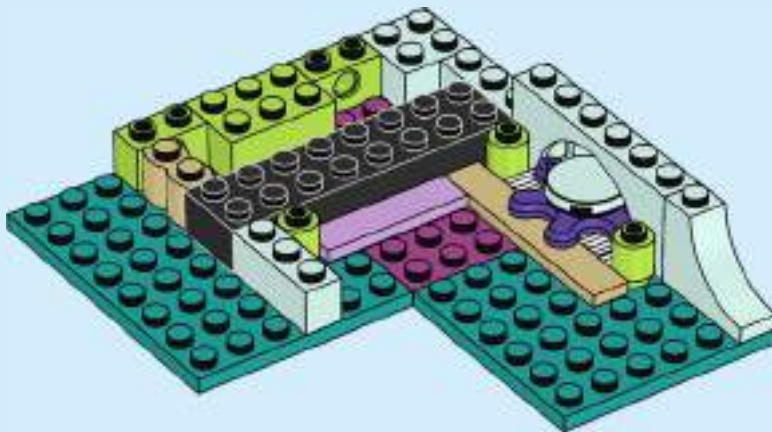





11



12

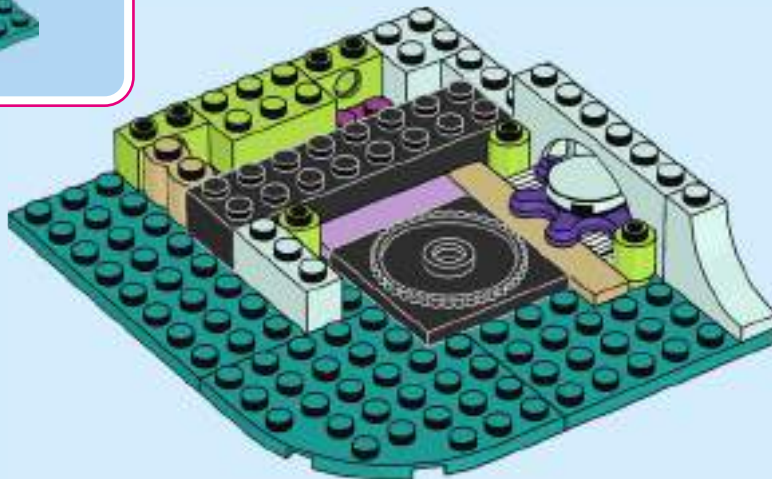



1x

13

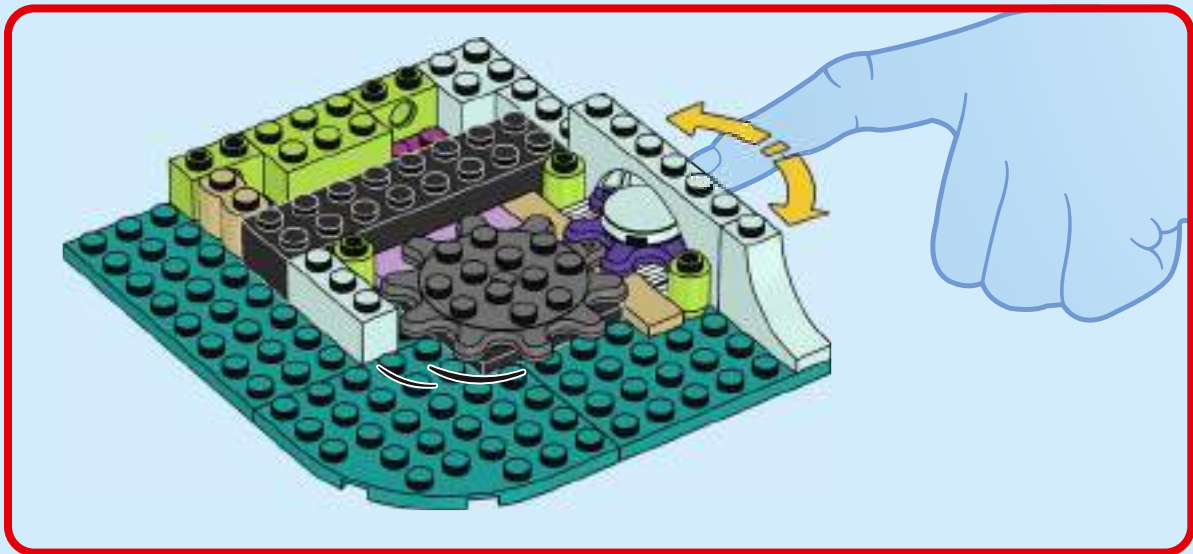
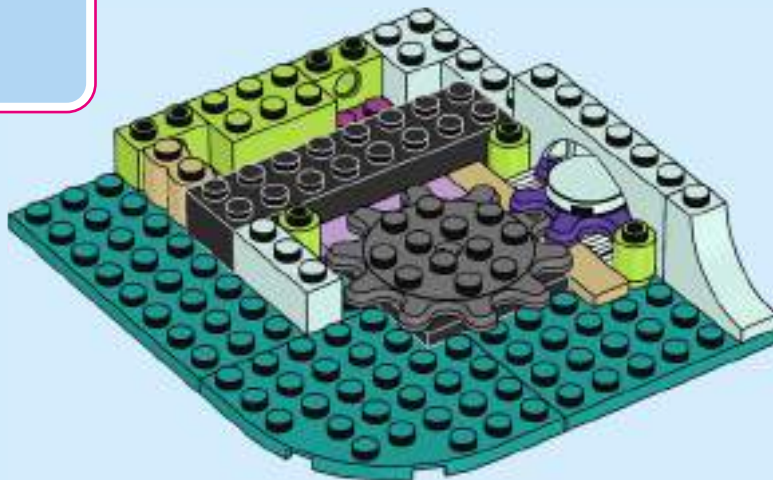

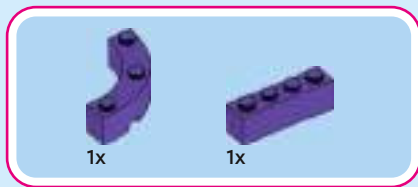

14

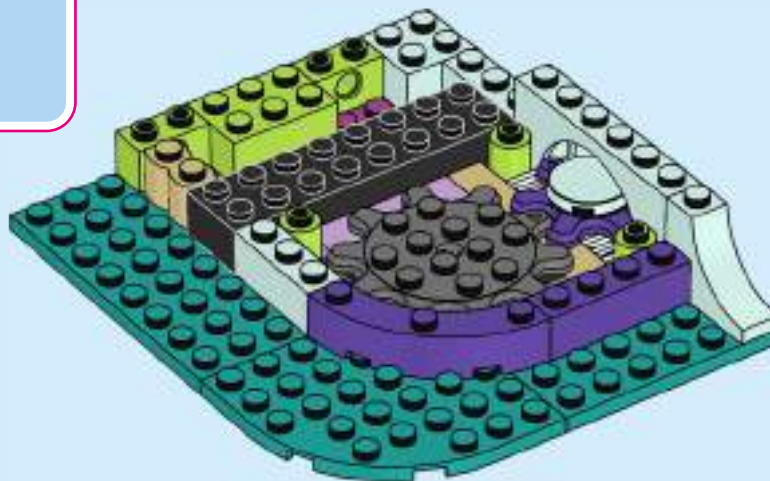

15

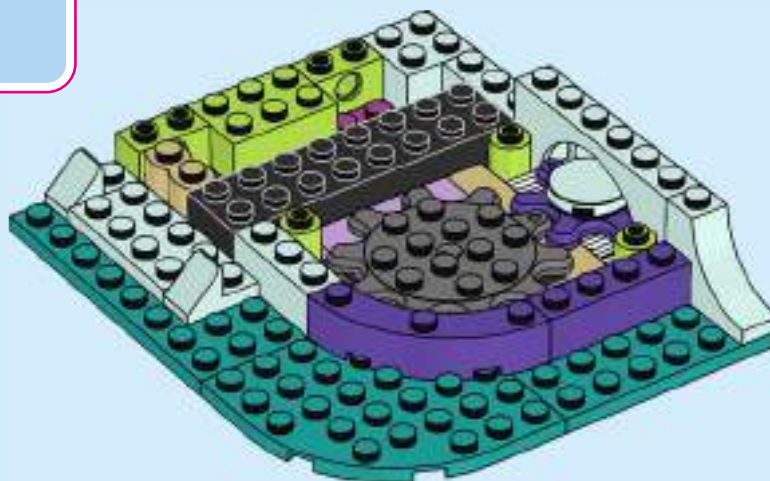



16

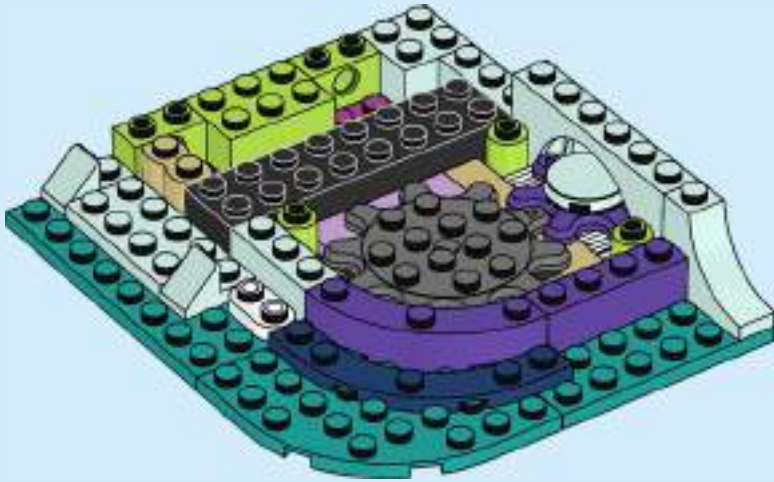



1x



1x

17

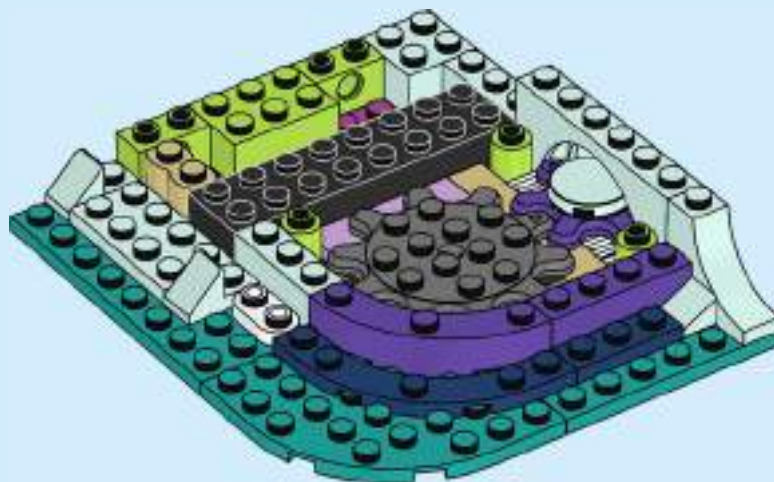

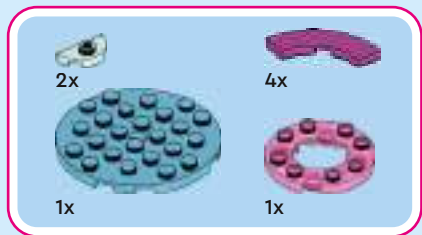

18

1

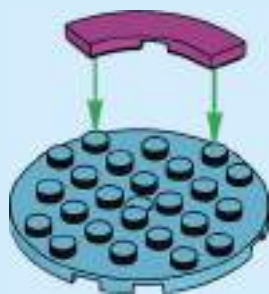

2



3





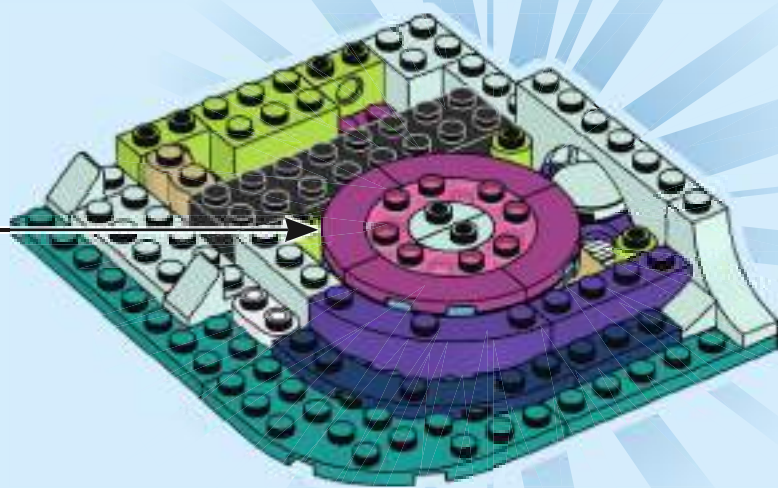

2x

1x

1x

19

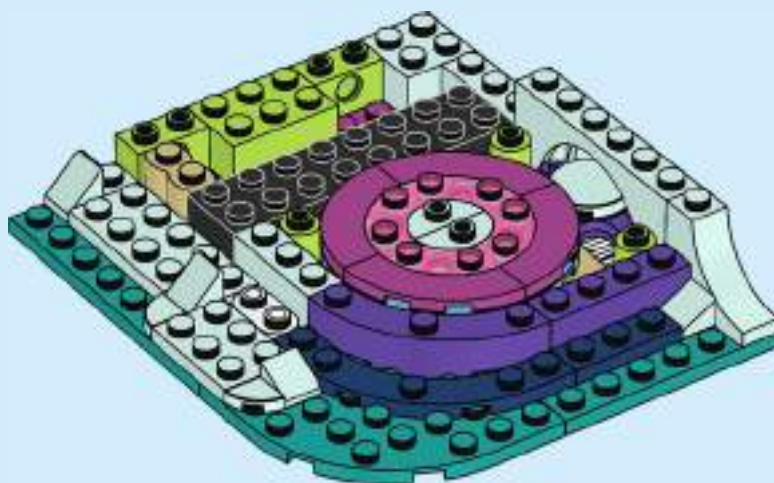



20

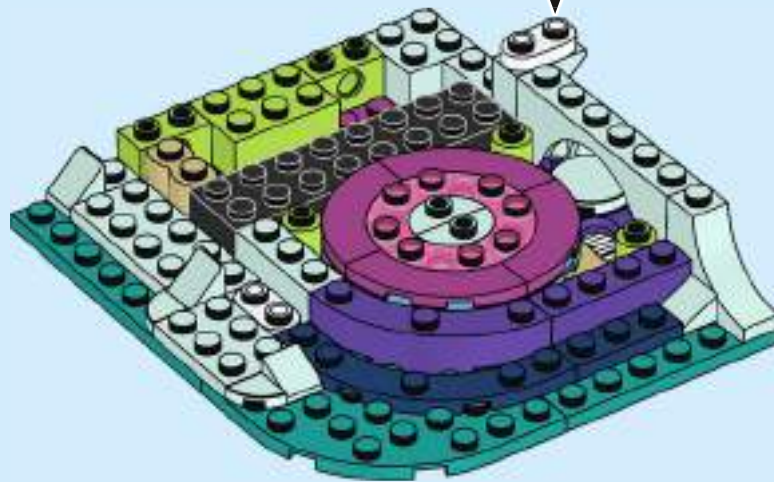
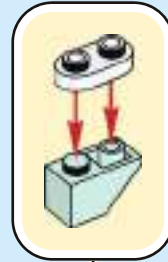



1x



1x

21

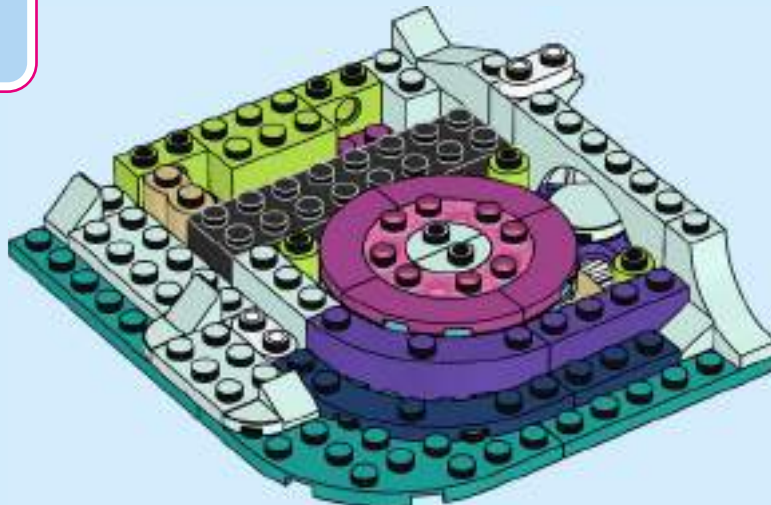

1x

22

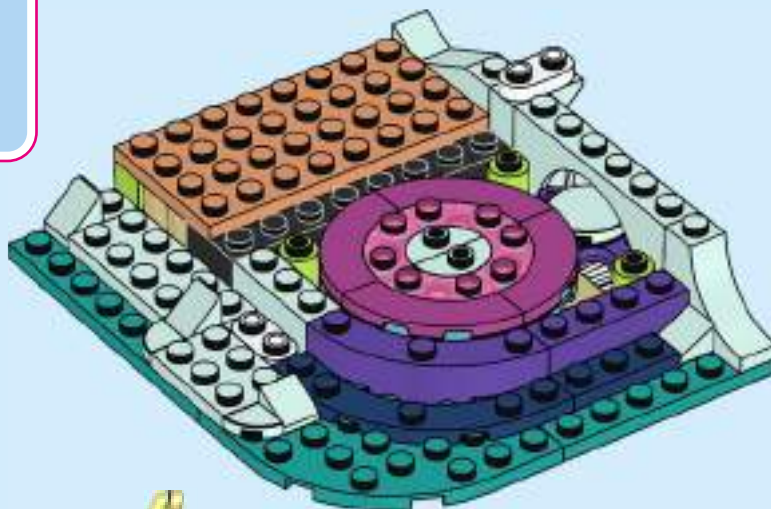

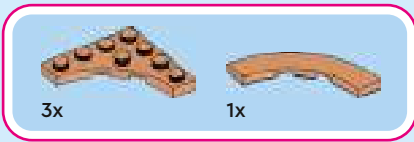

23

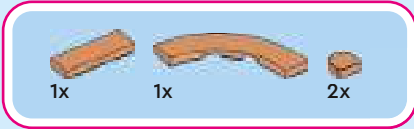
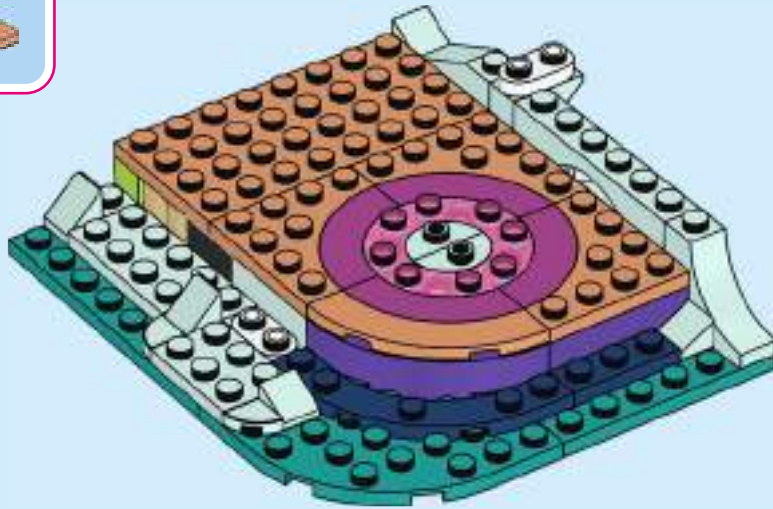

24

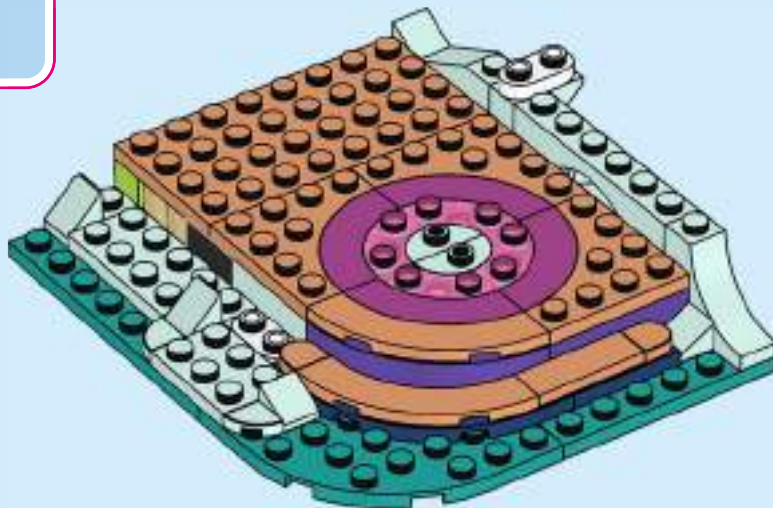



1x



2x

# 25

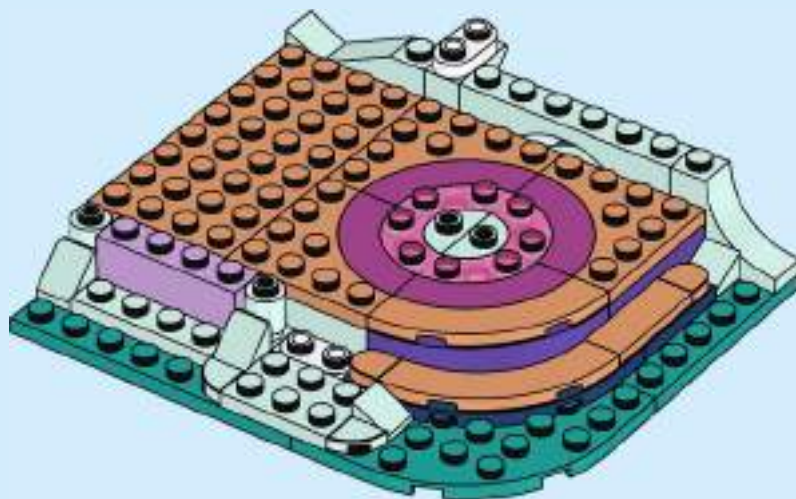





3x



1x

26

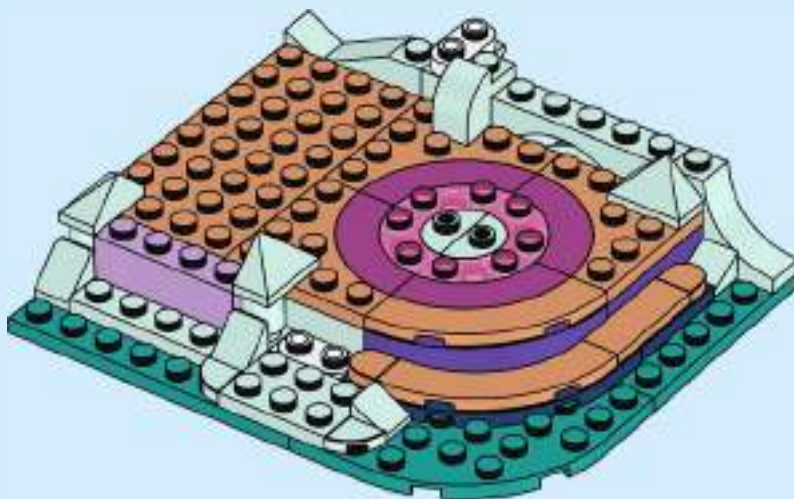



2x

27

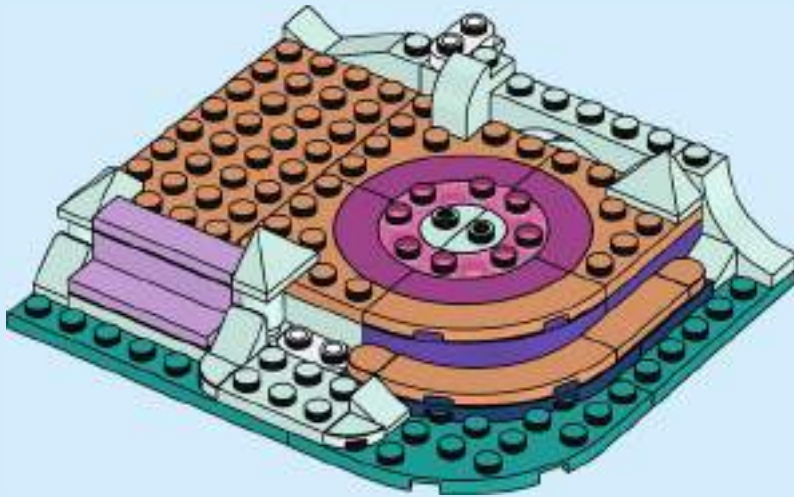

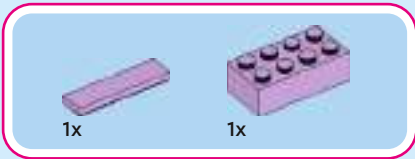

28

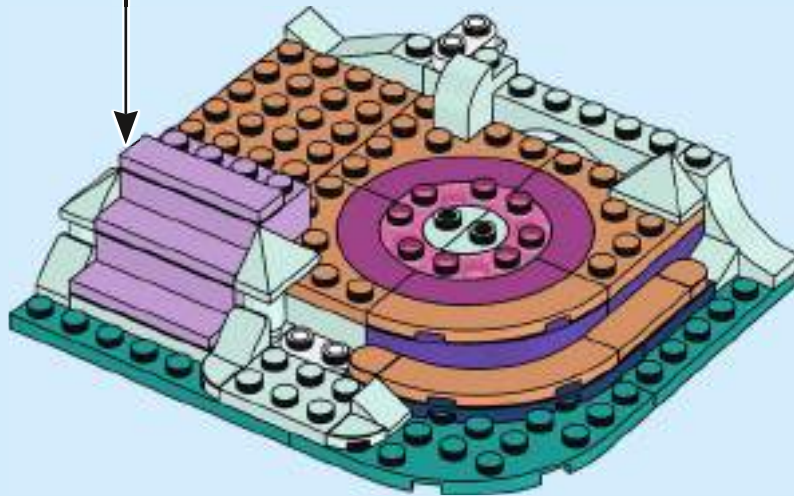
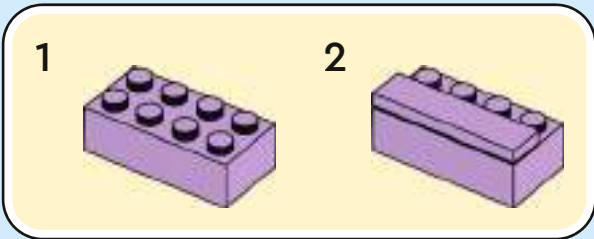

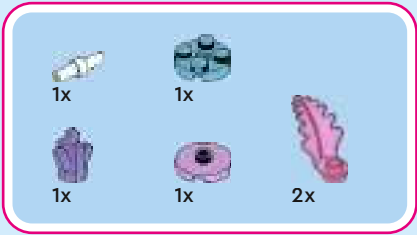

29

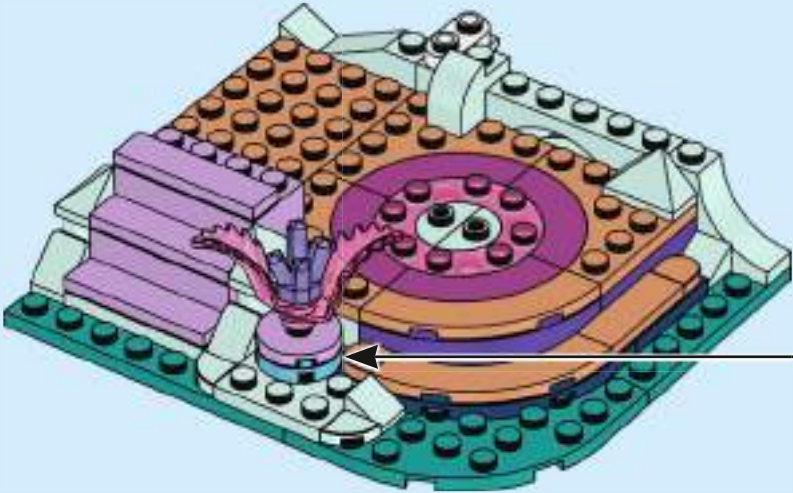
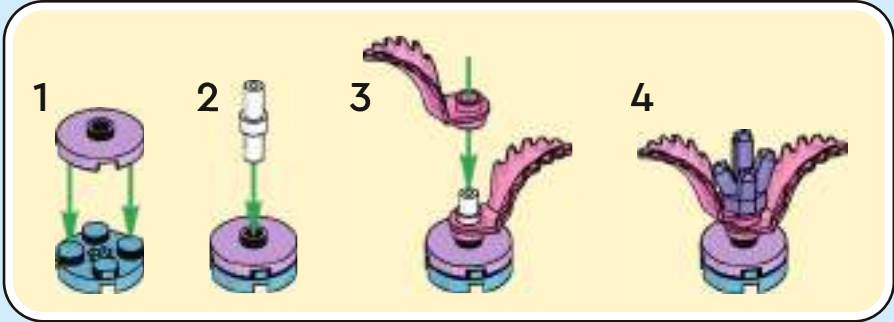



1x

30

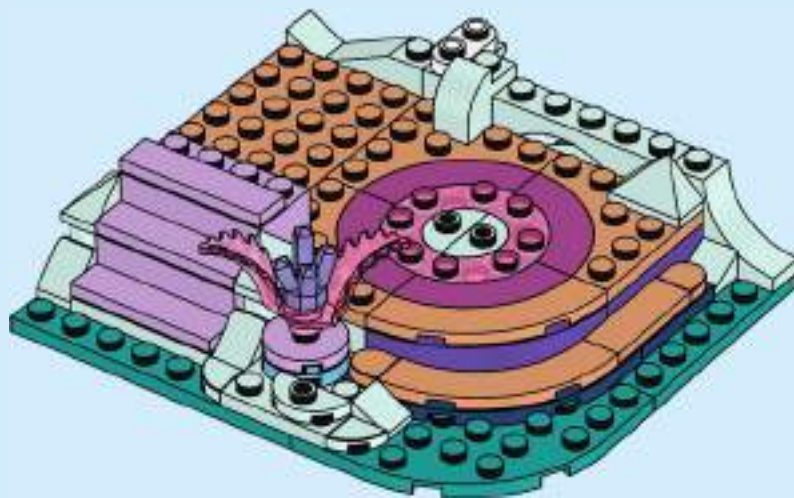



2x



2x

31

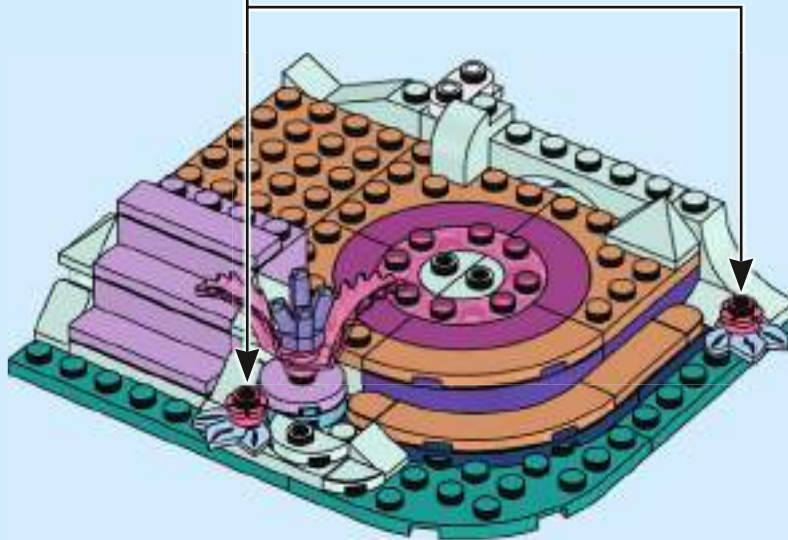





1x



1x

# 32

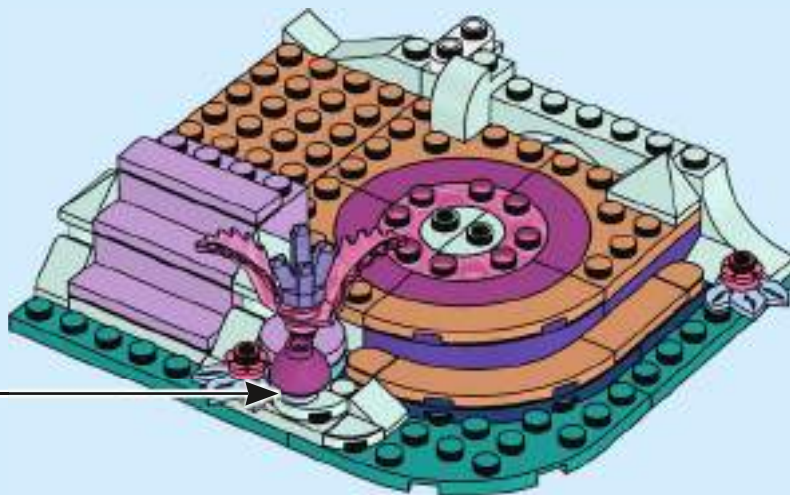

1x



1x



1x

# 33

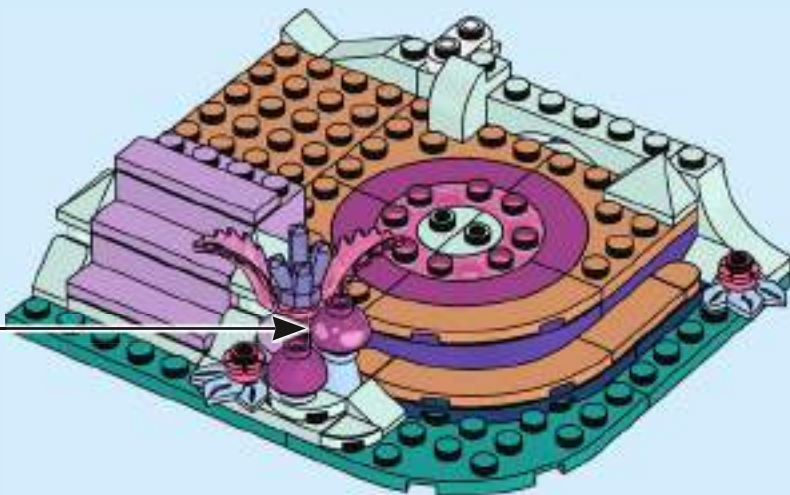



1x



1x

# 34

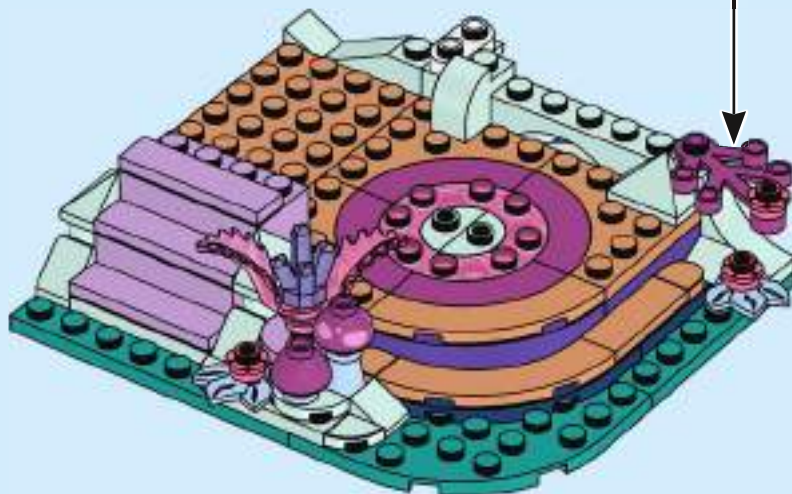
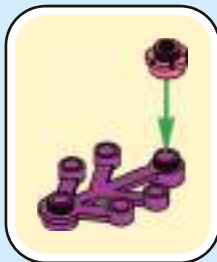



3x

35

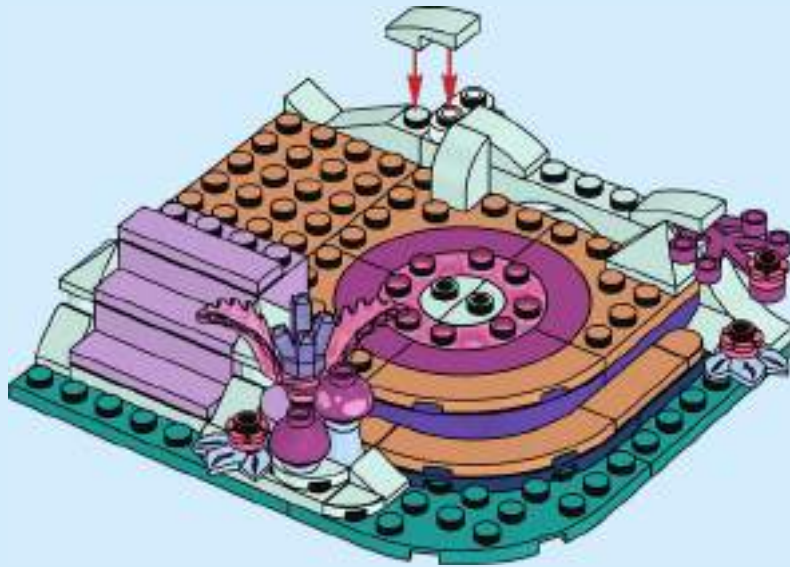



2x

# 36

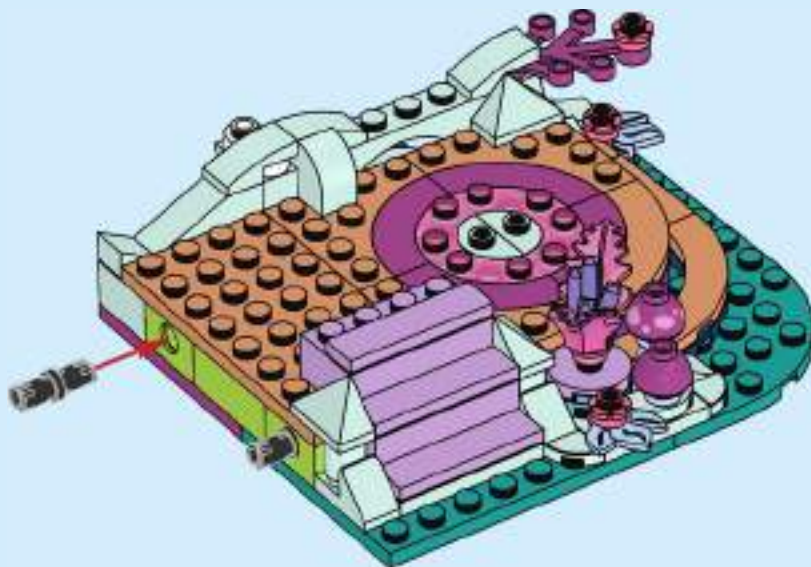

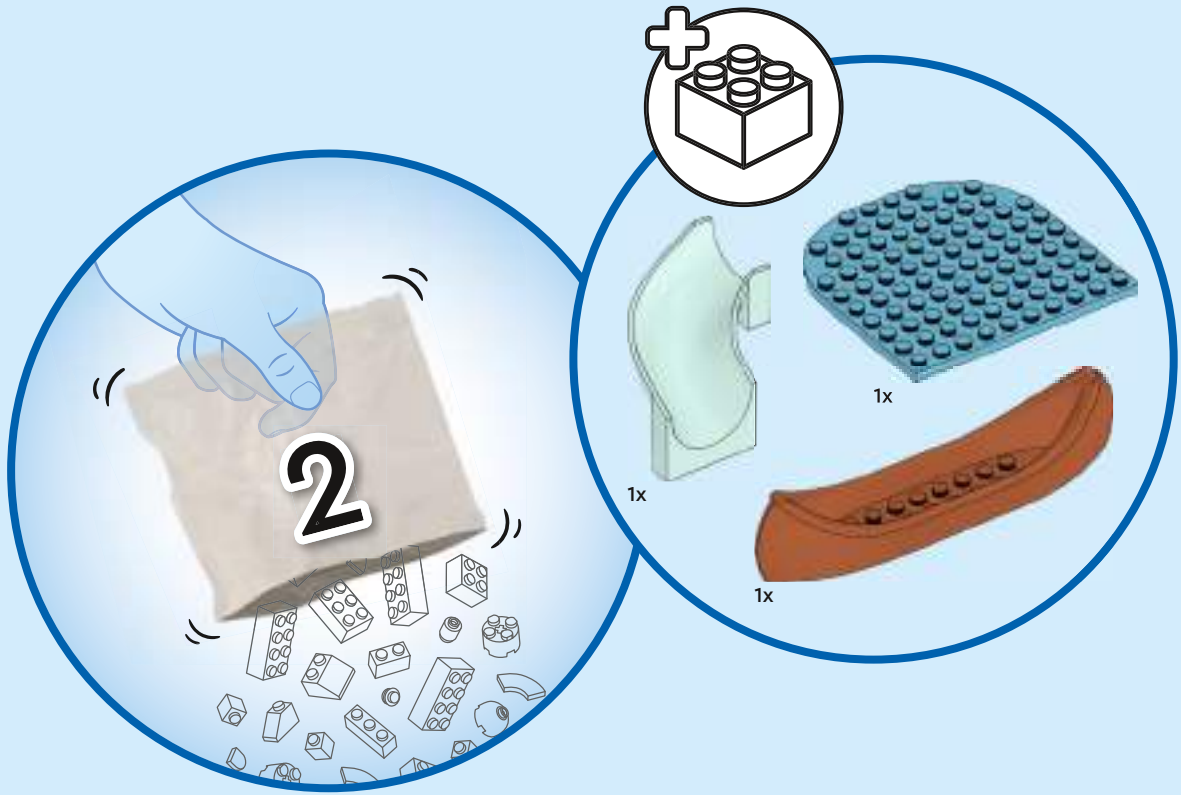

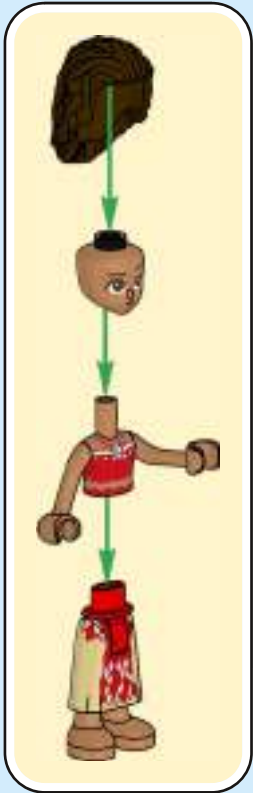



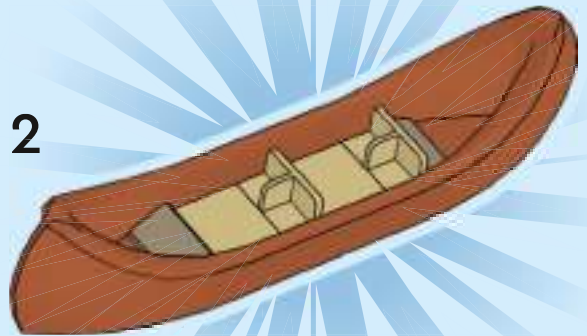
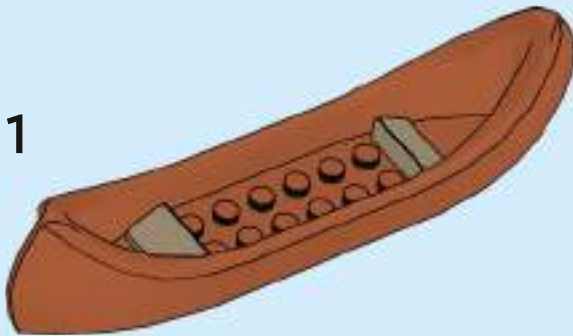
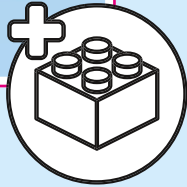
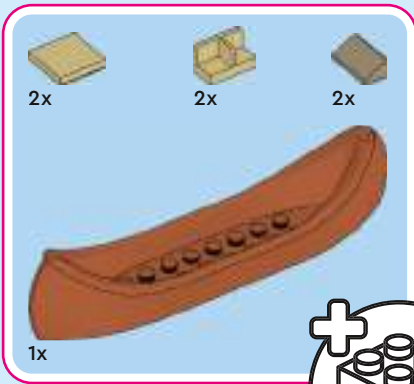



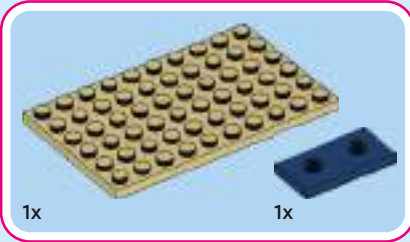

37

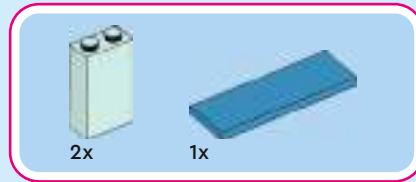
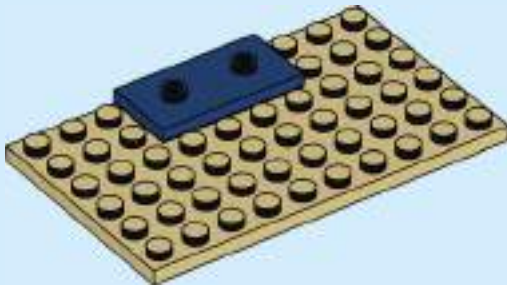

38

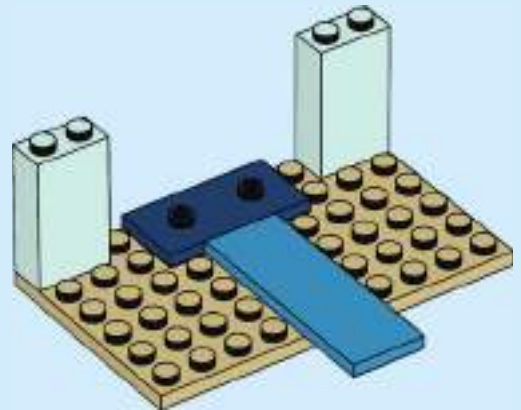



39

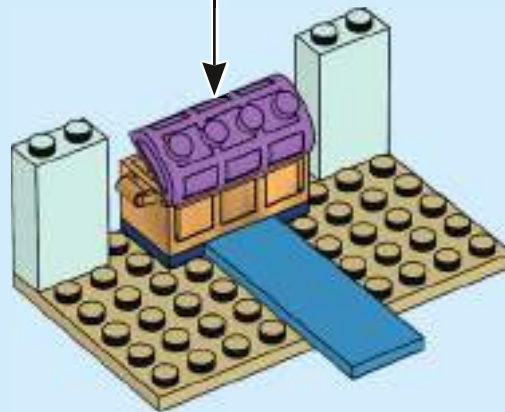
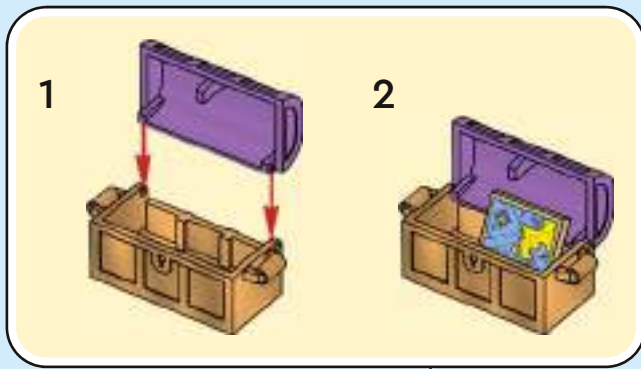

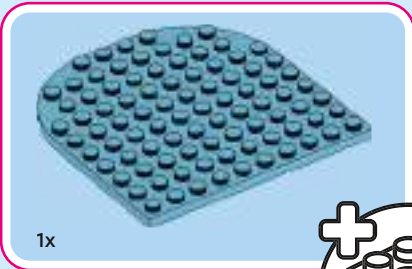

1x

40

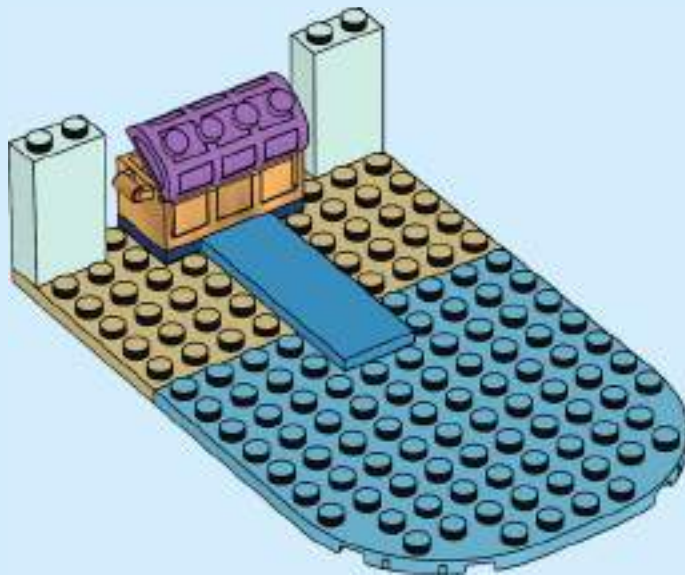
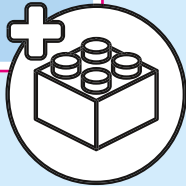



41

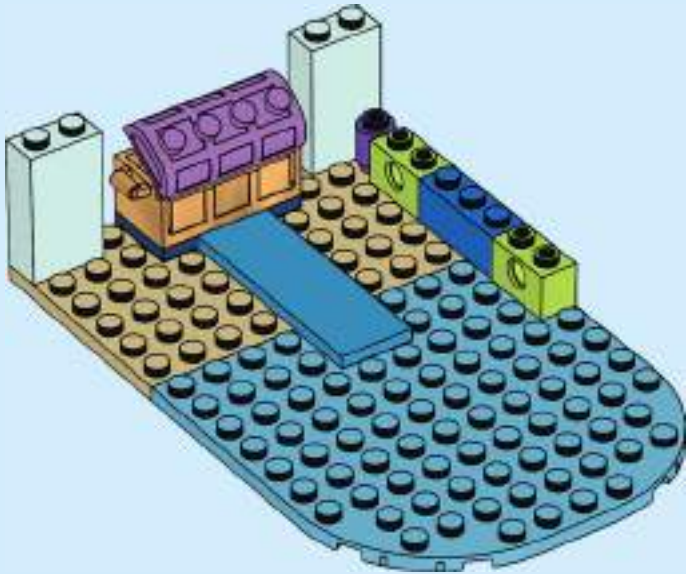



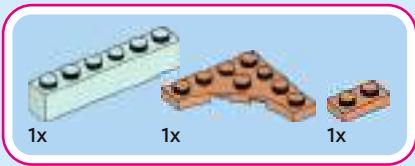

42

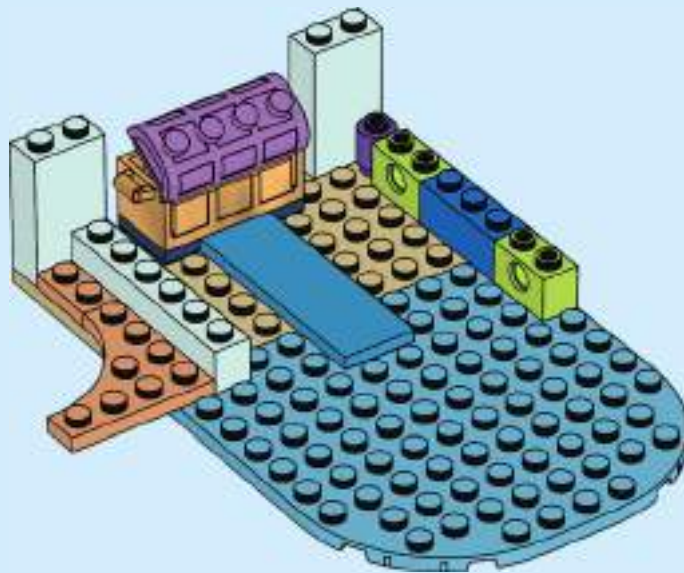



43

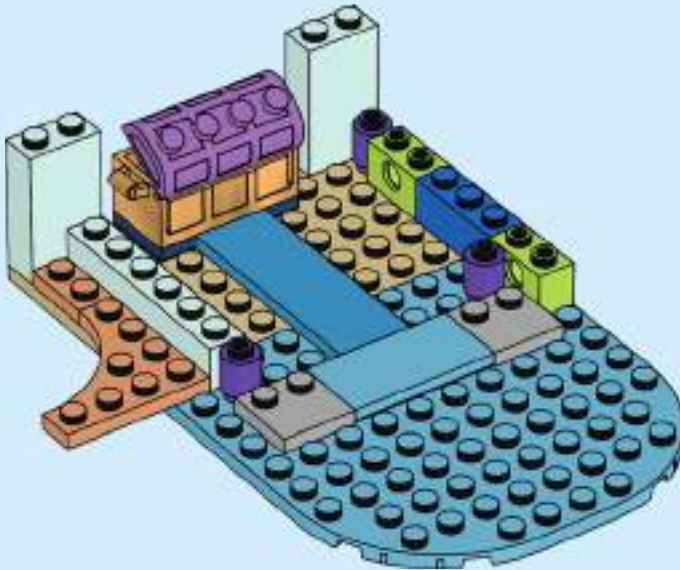



44

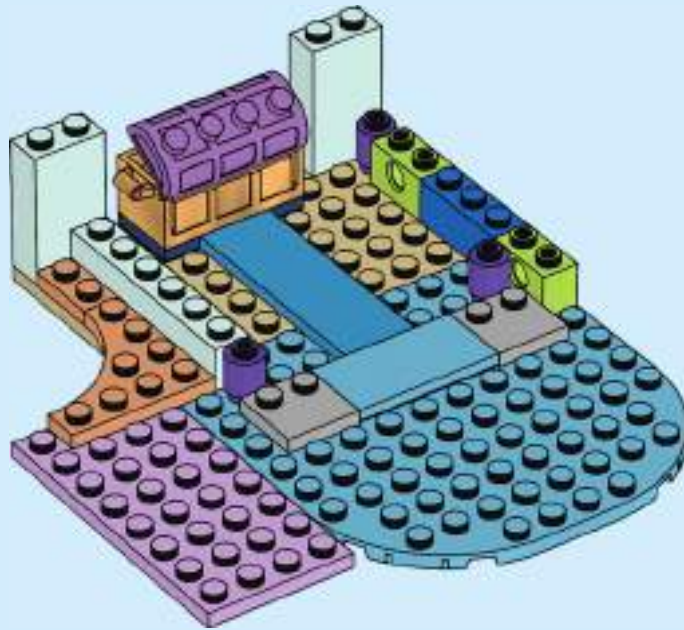

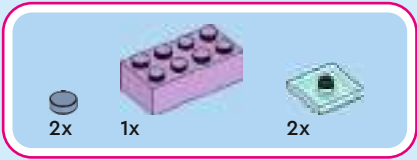

45

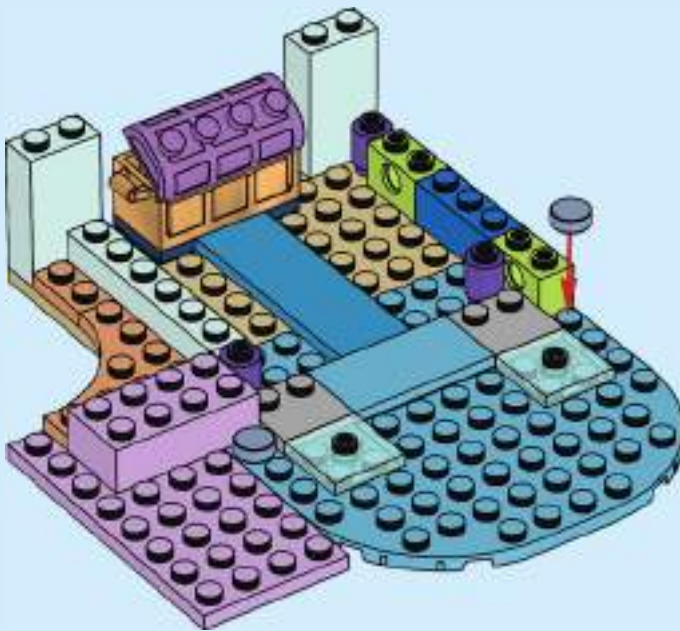







1x

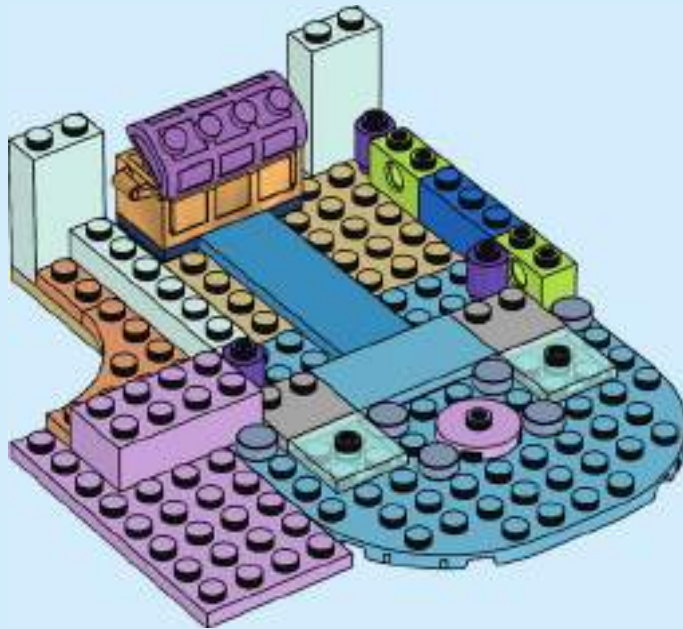

4x

46



1x  2x  1x 

47

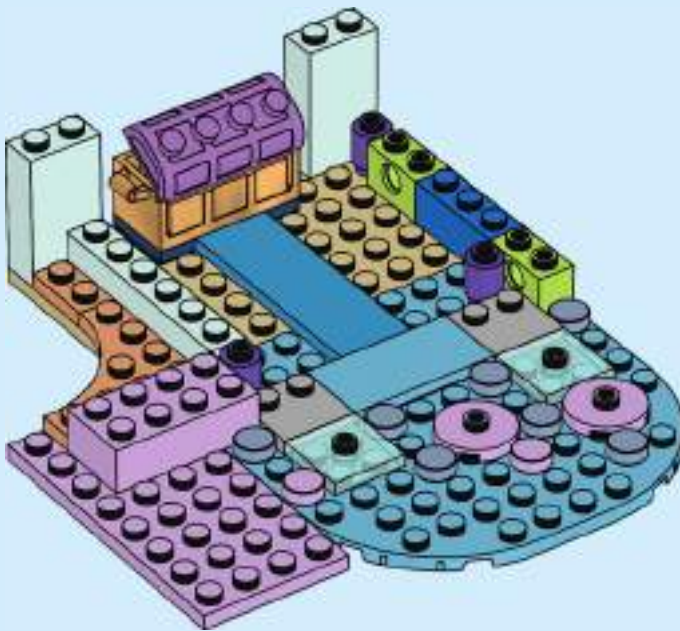





1x



1x

# 48

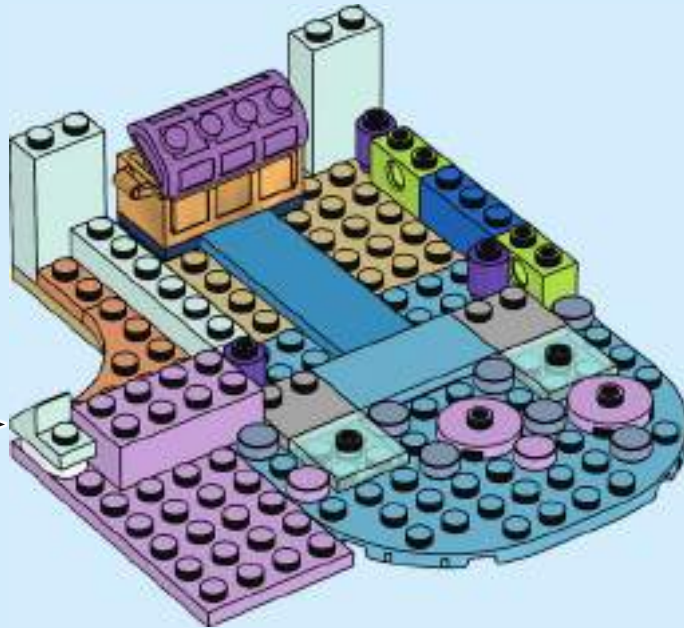
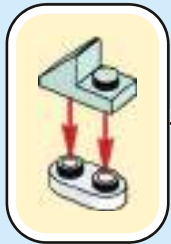



2x

49

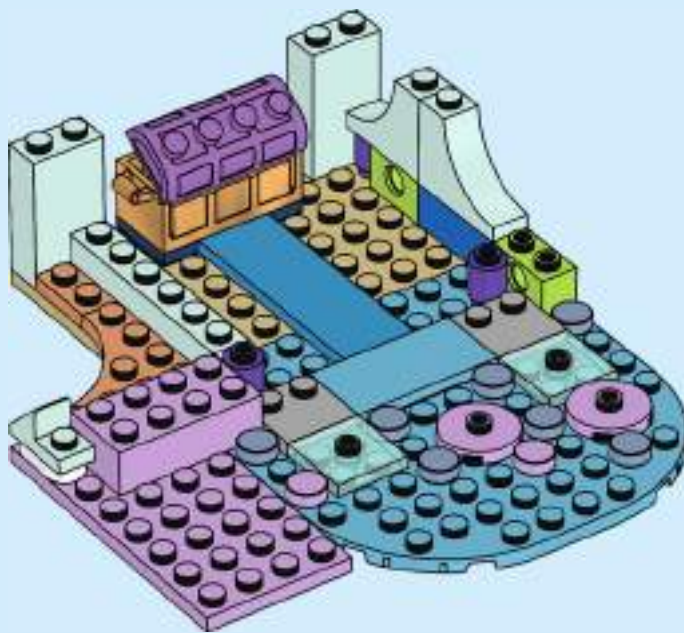



1x



1x

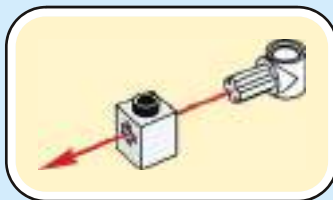

50

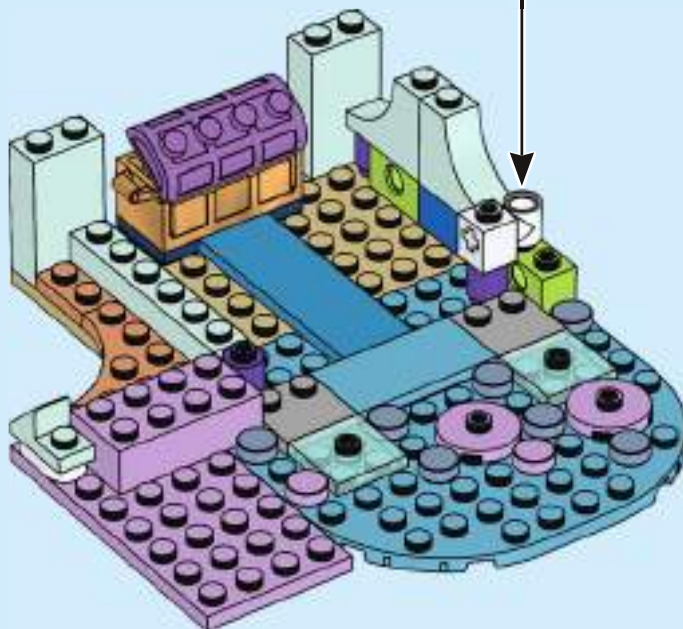



1x



1x

51

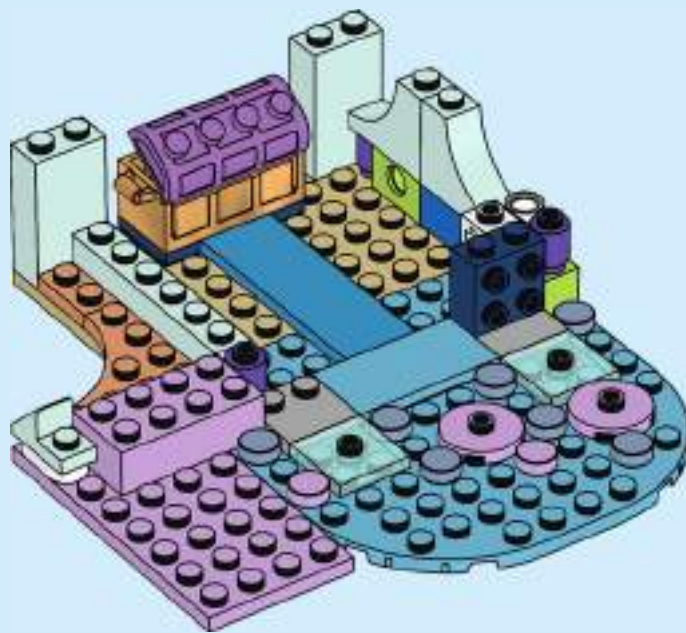



1x



1x

# 52

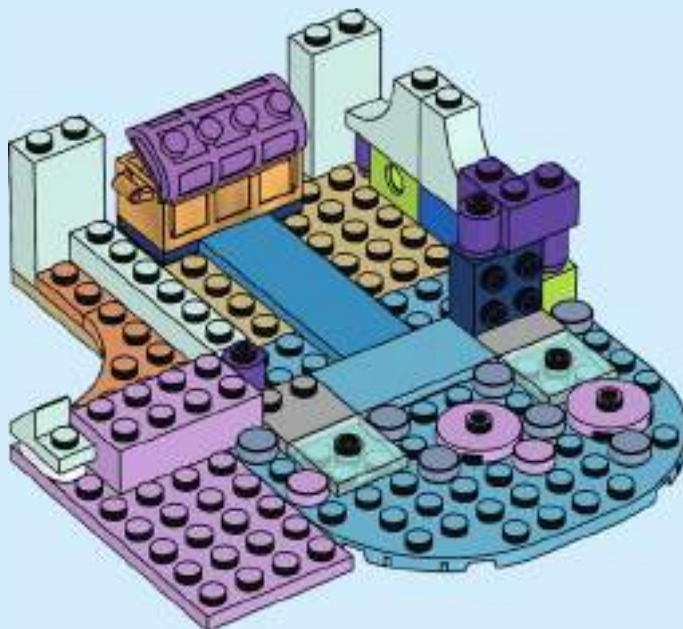

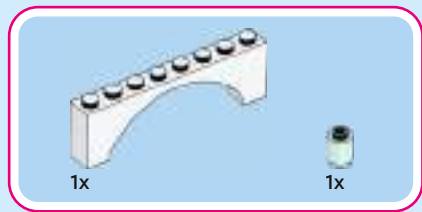

53

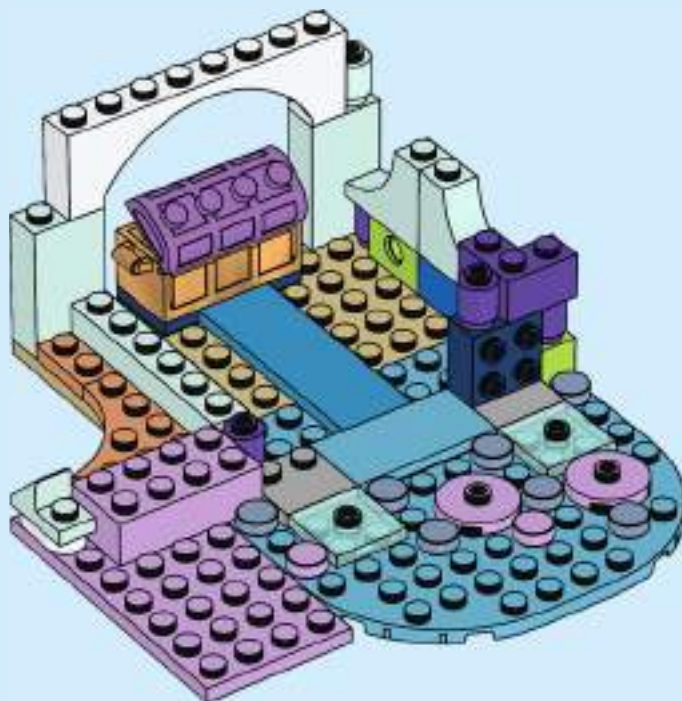





1x



1x

# 54

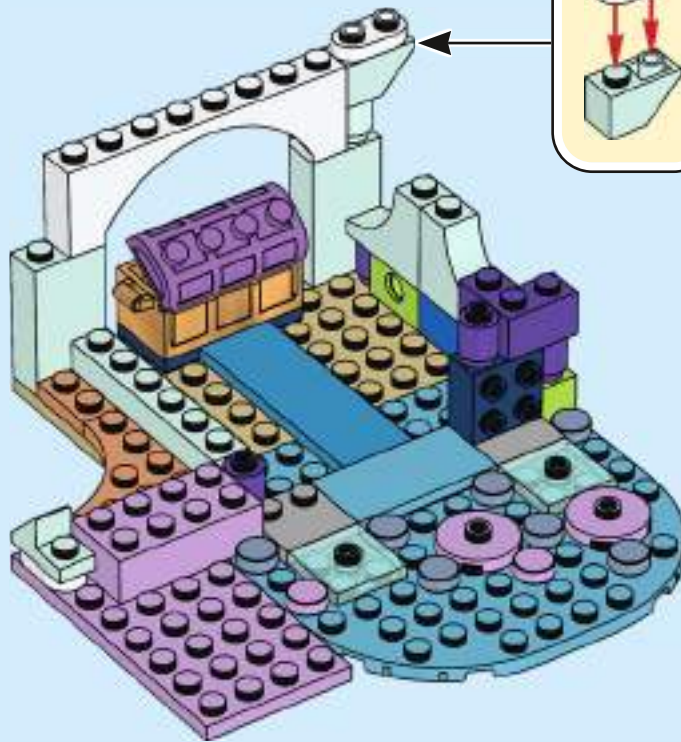

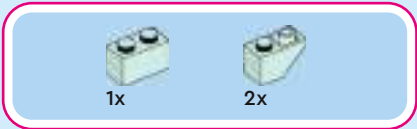

55

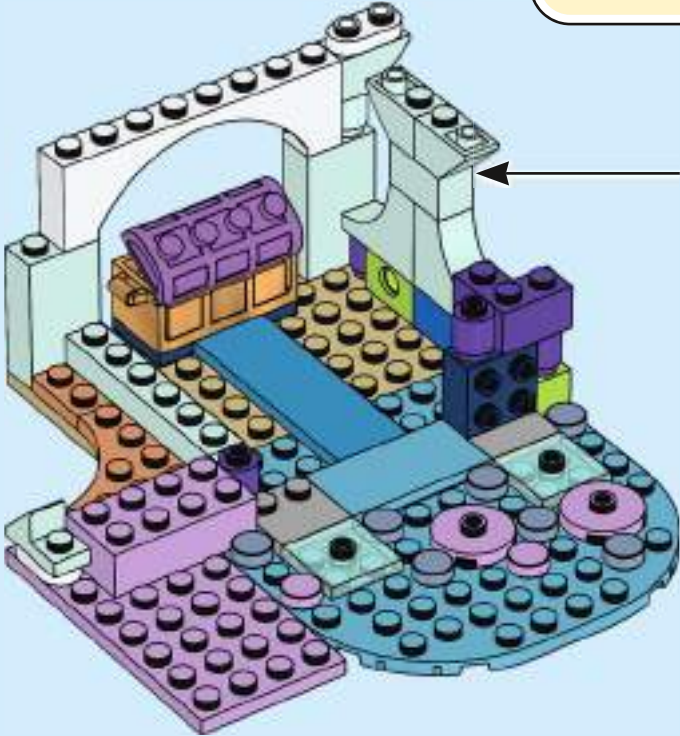
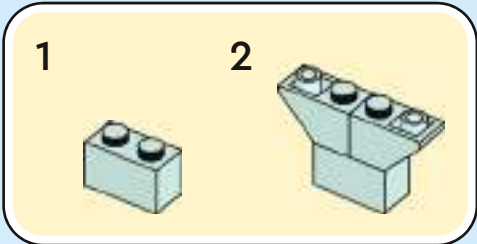

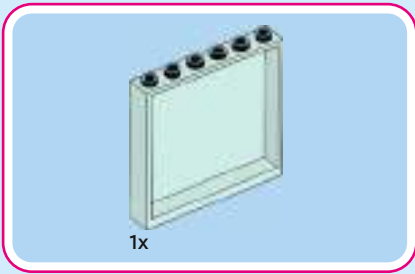

56

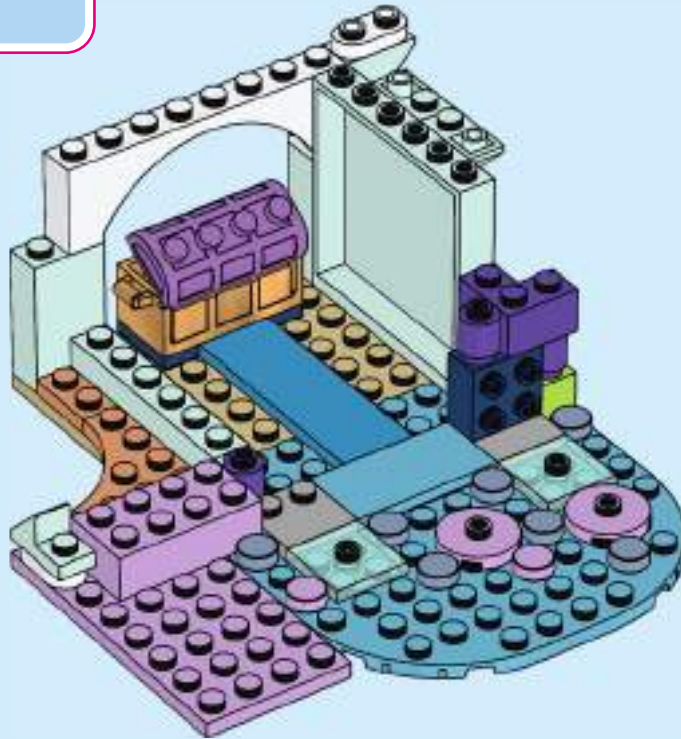



57

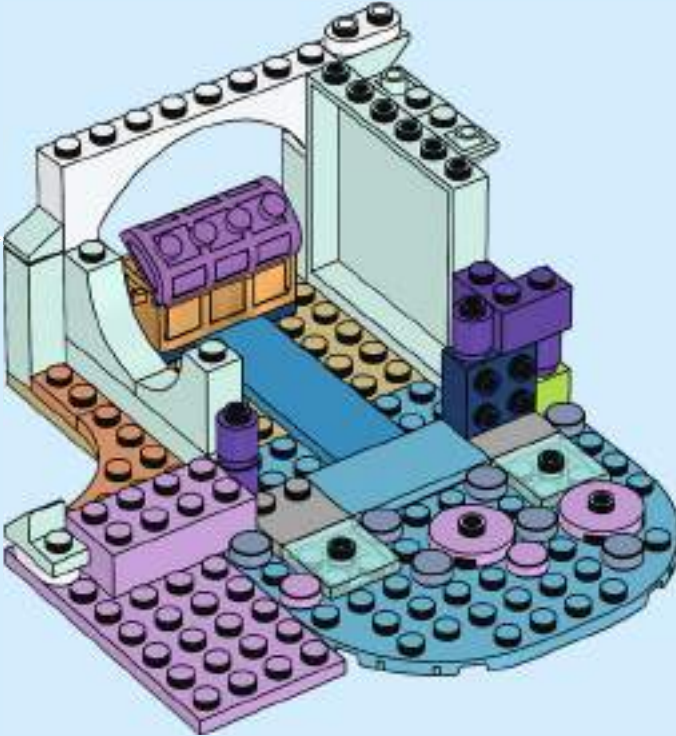

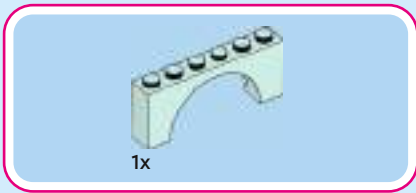

58

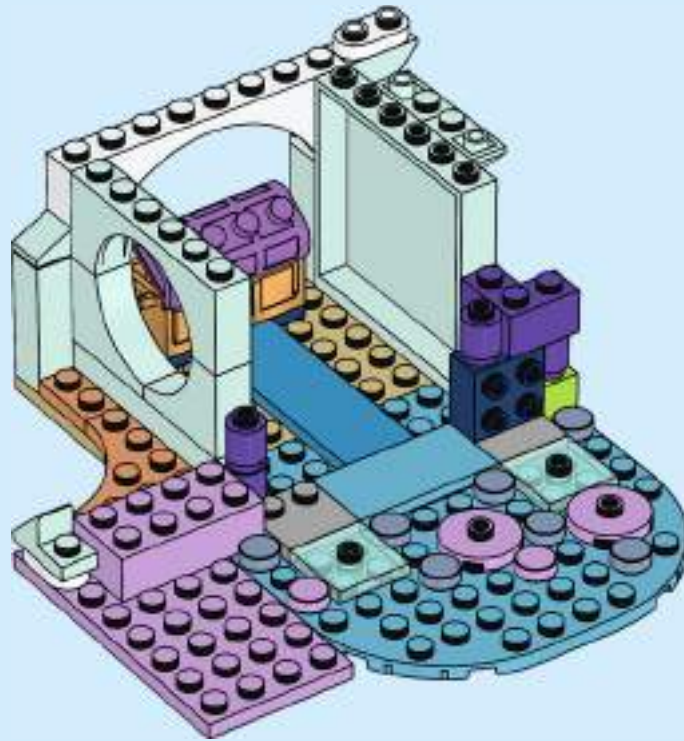

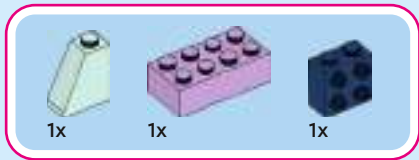

59

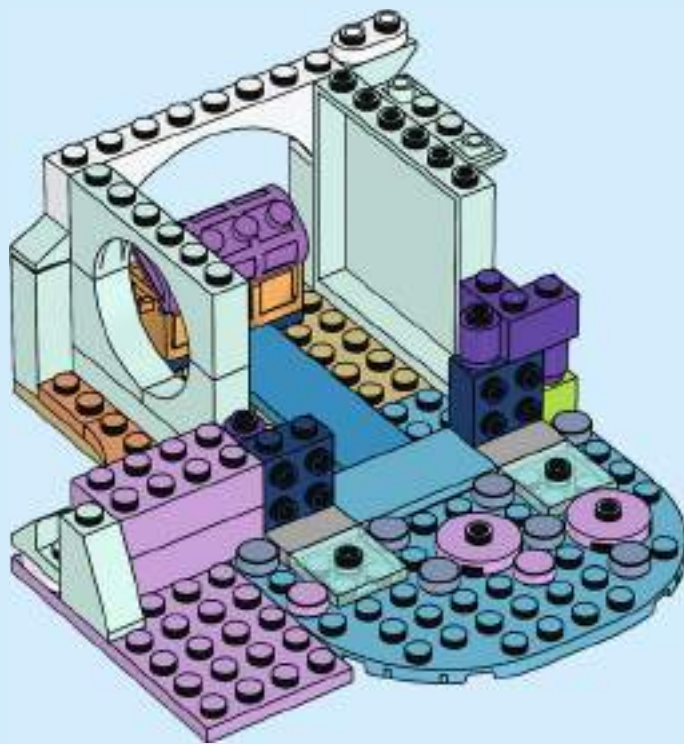





1x



1x

60

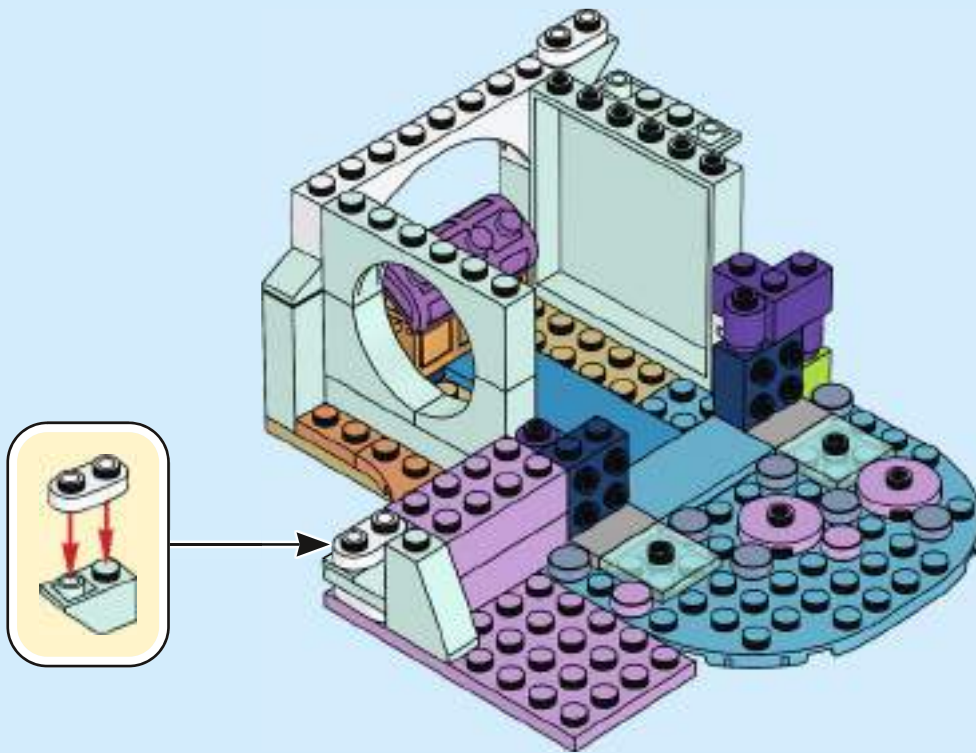

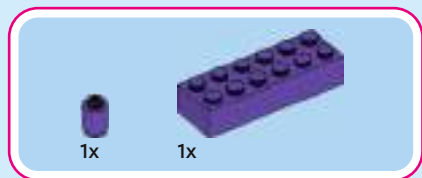

61

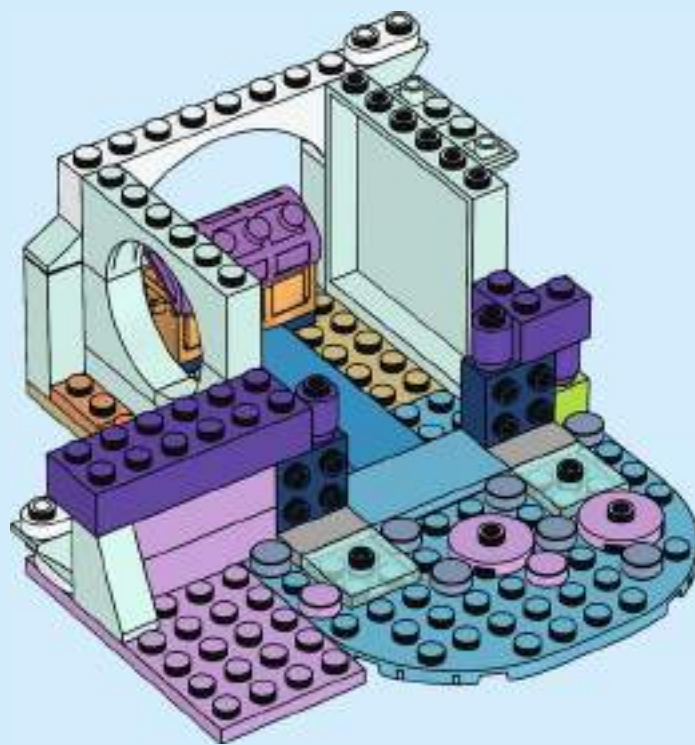

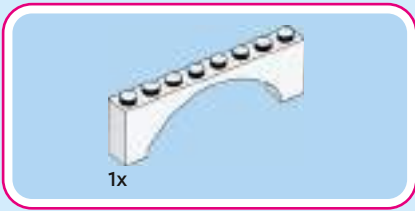

62

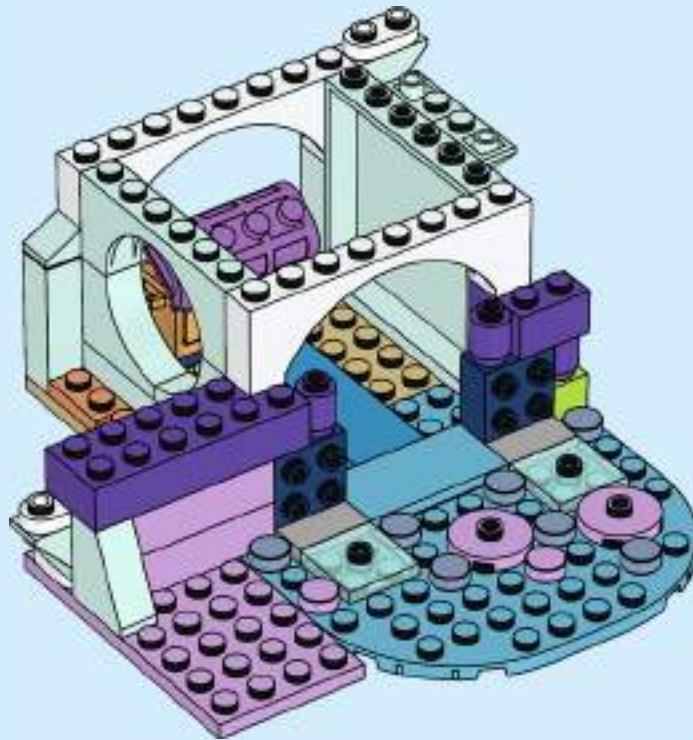

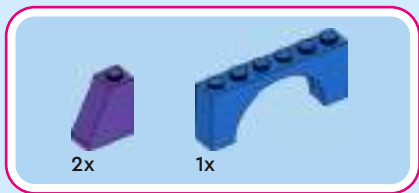

63

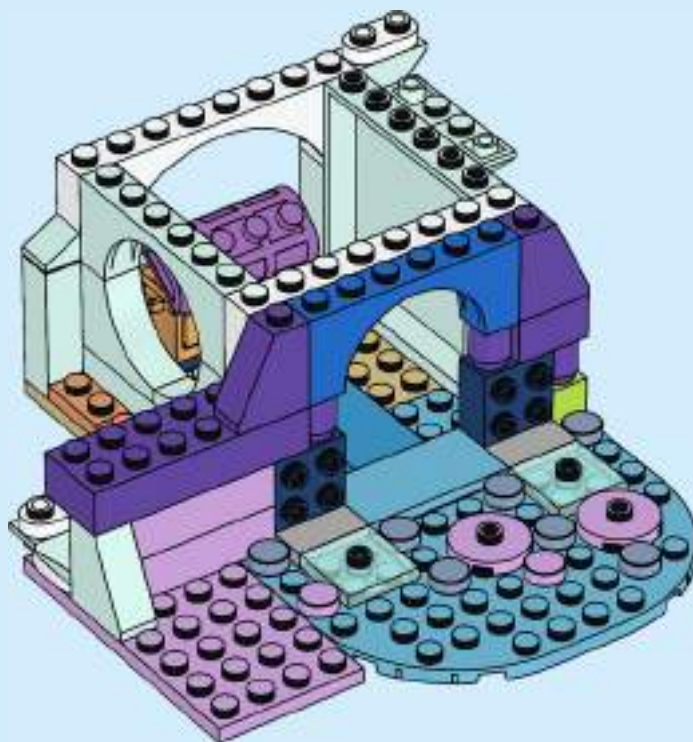



2x



1x

# 64

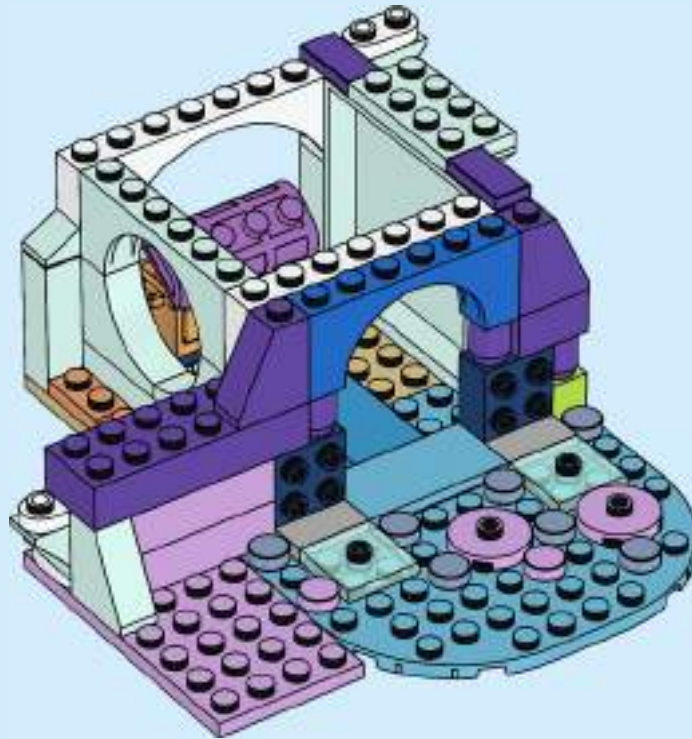



65

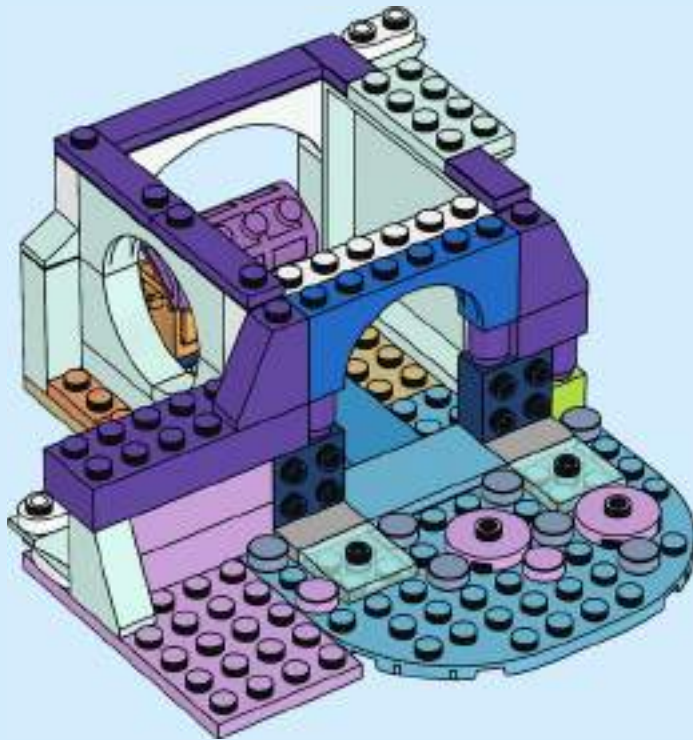





2x



2x

66

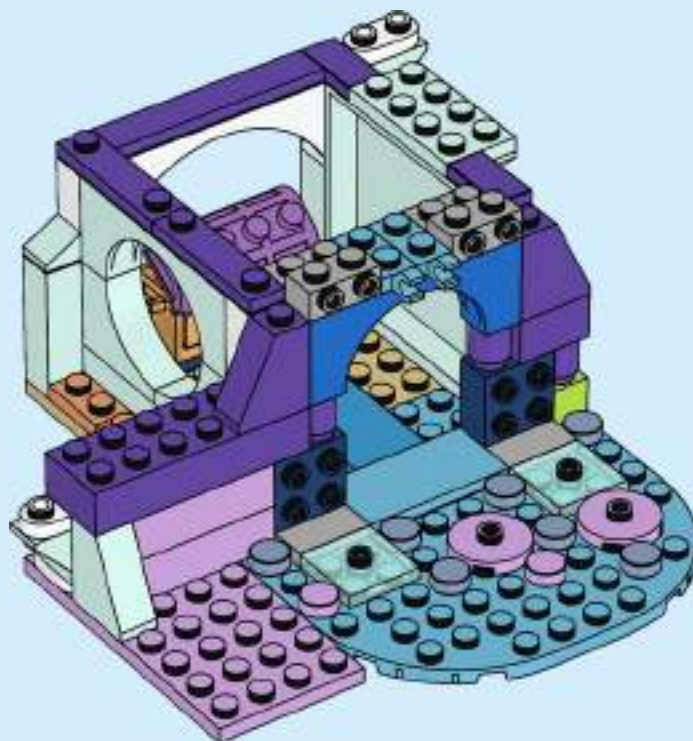



67

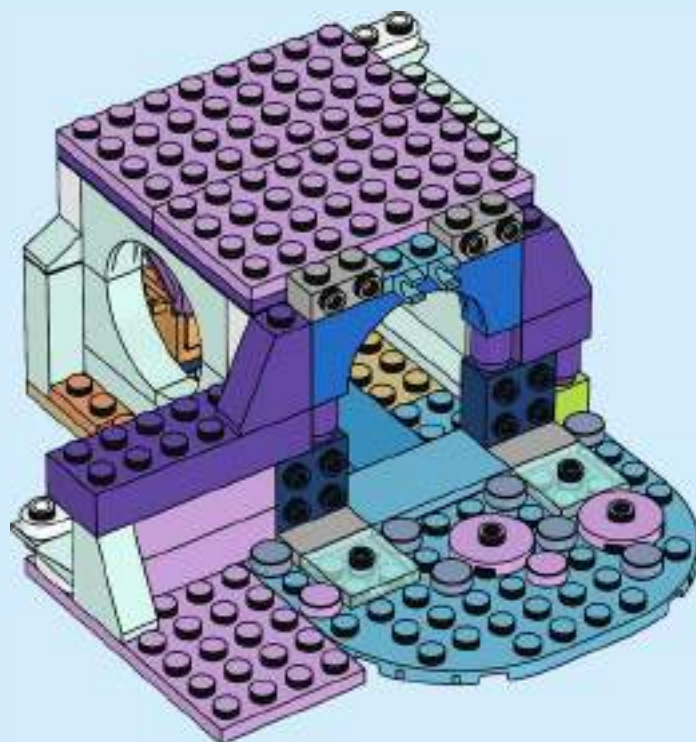



2x



1x



68

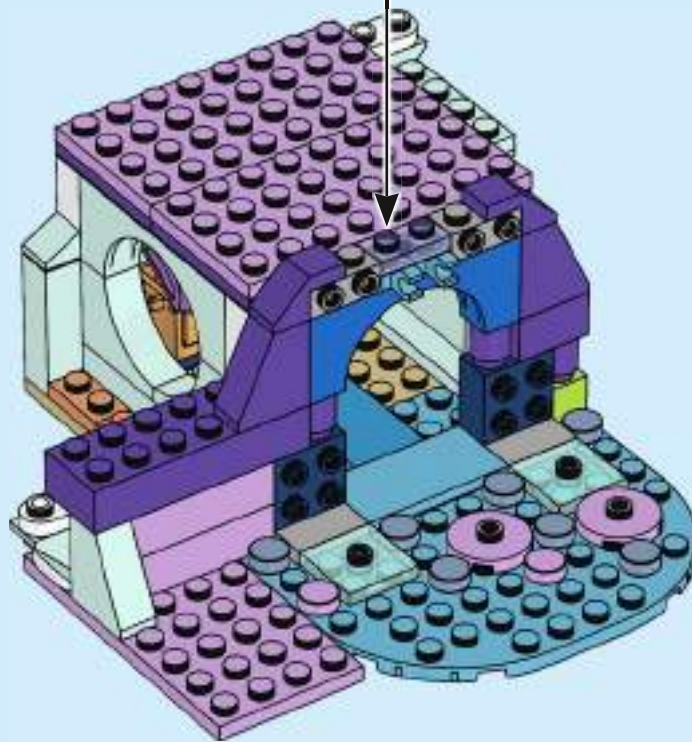



69

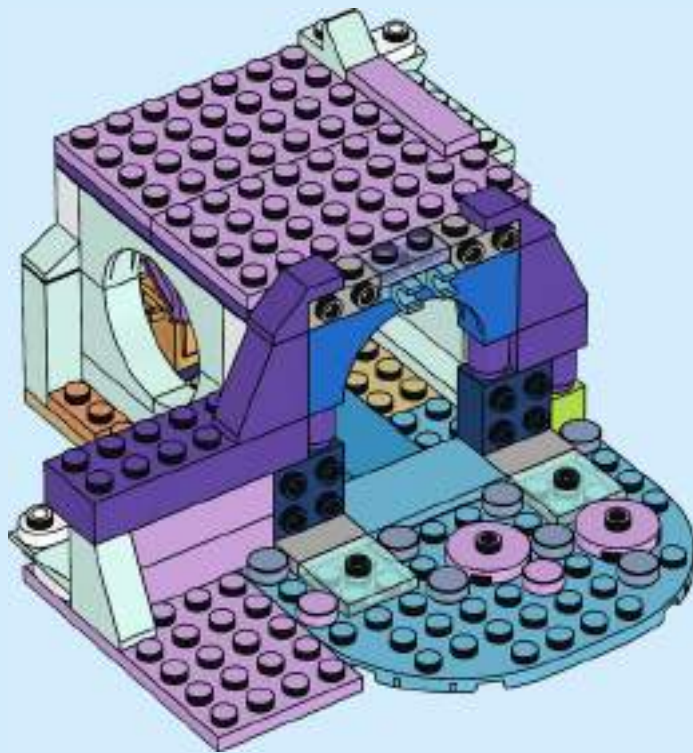



1x



1x

70

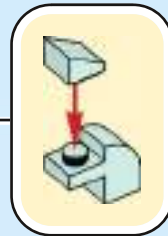
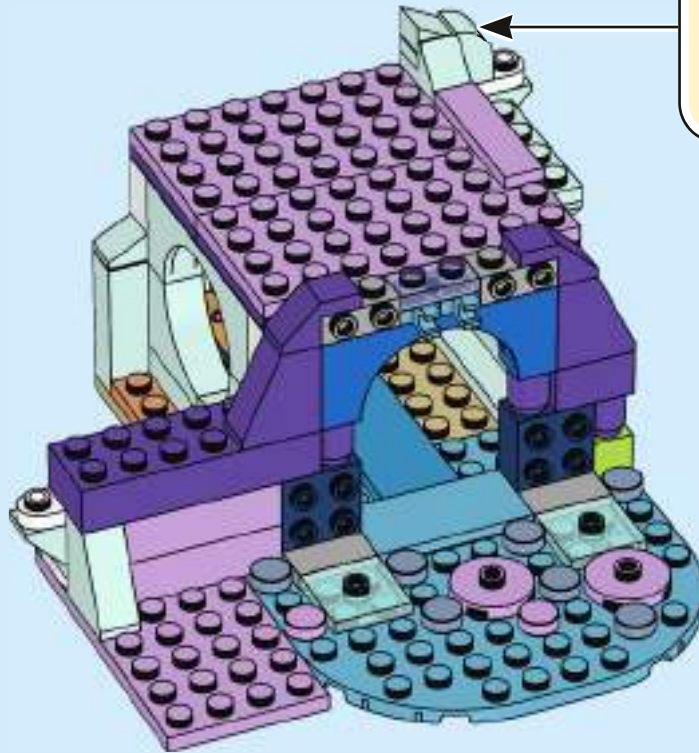



3x

71

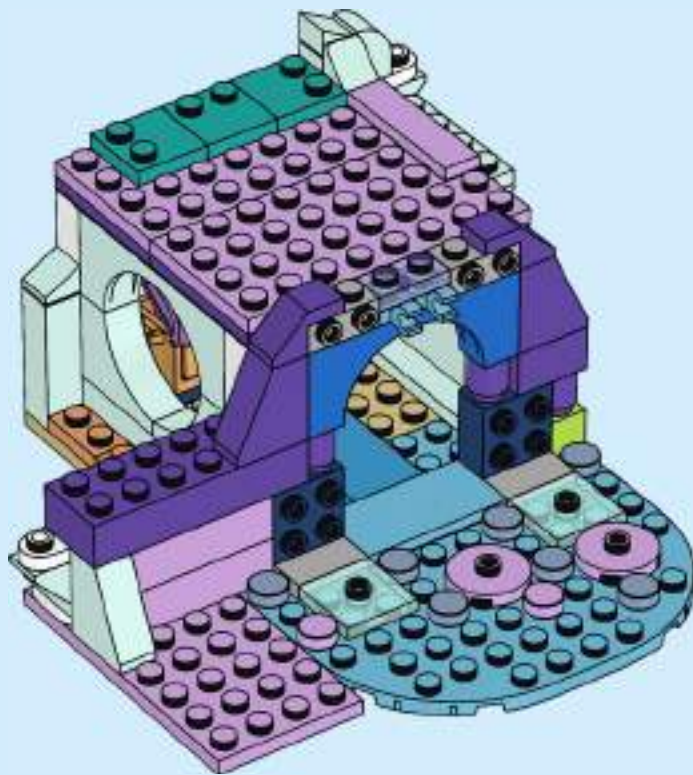





1x



1x

# 72

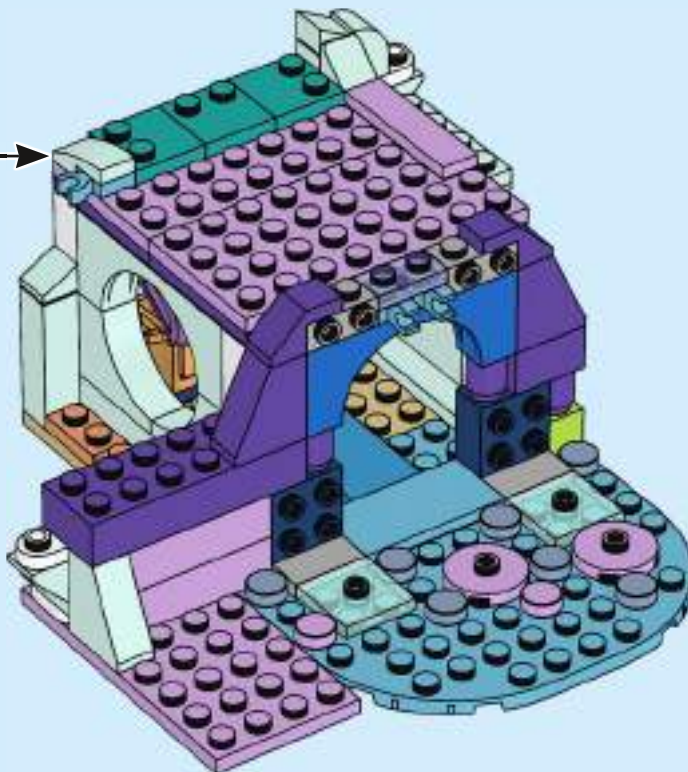
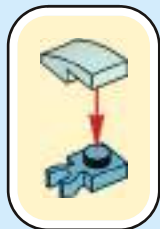



1x



2x

73

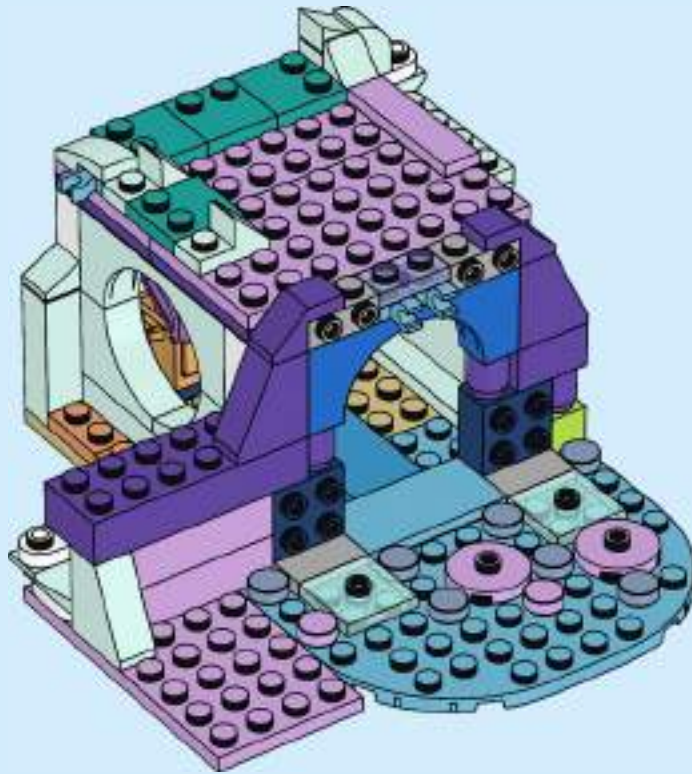



74

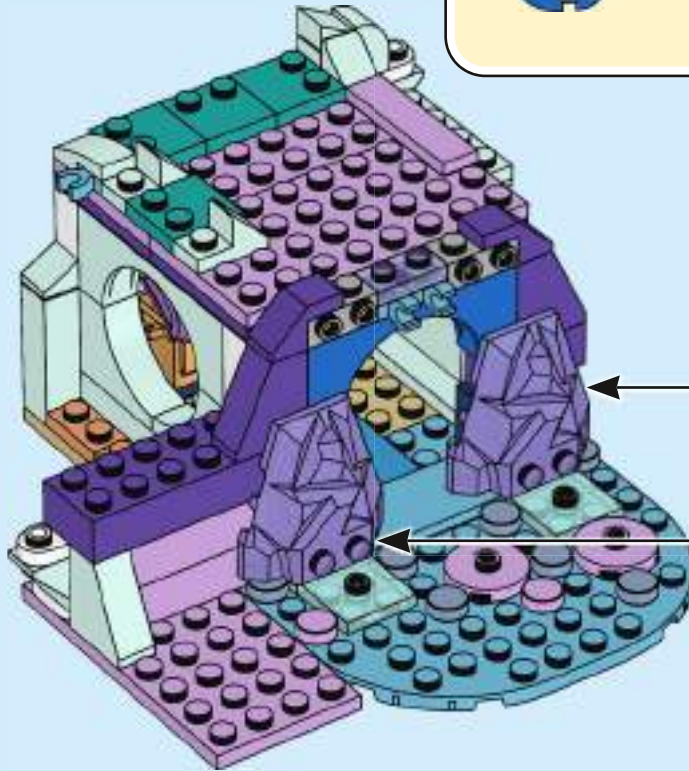
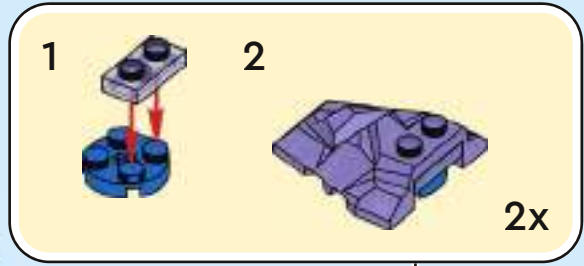



2x



2x

75

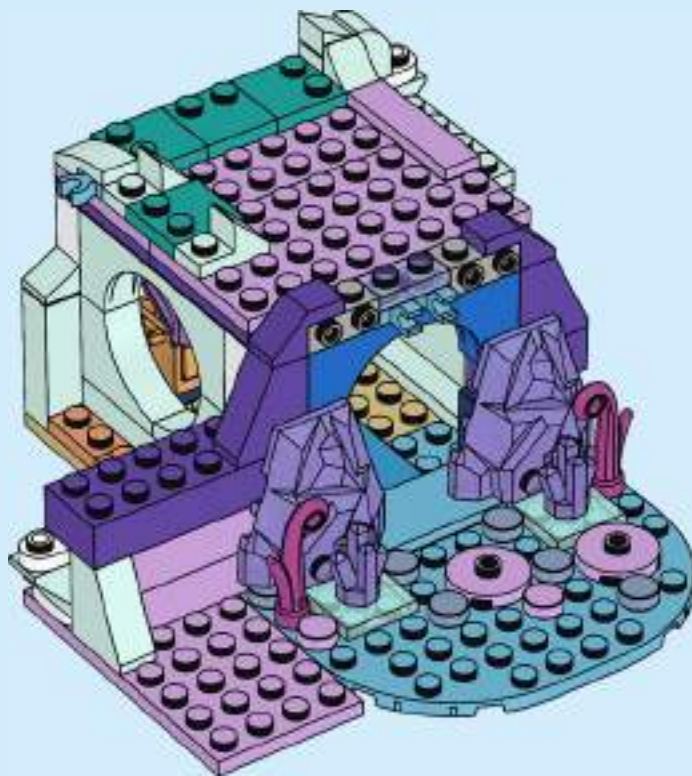



76

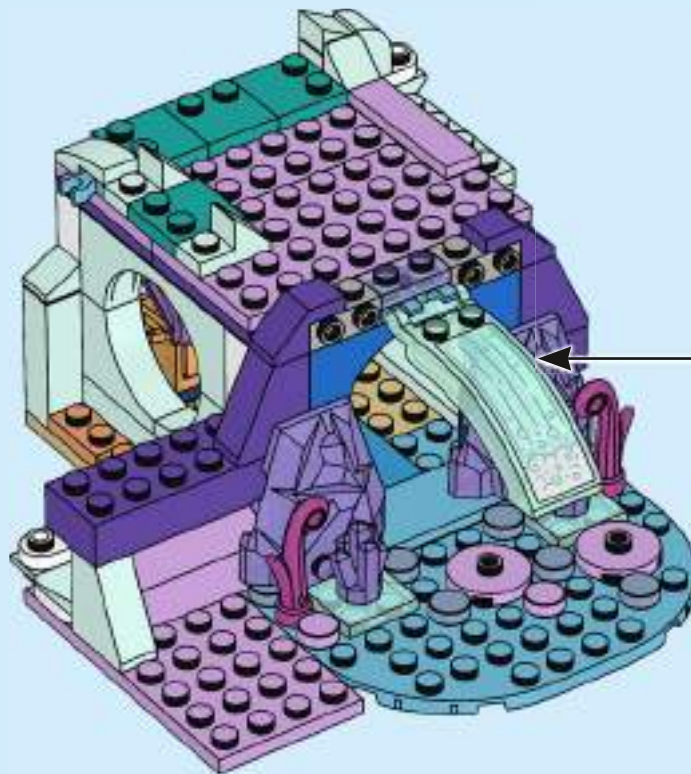
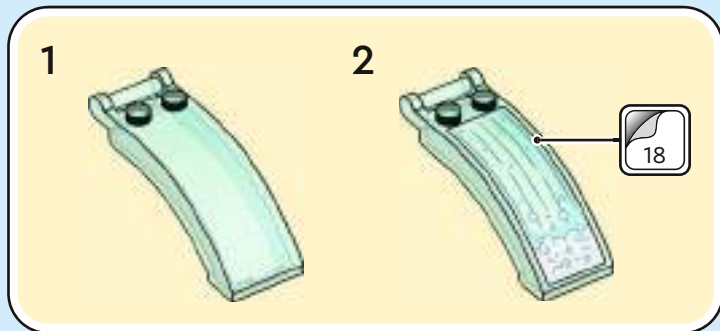



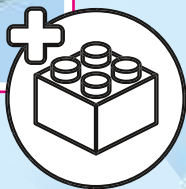
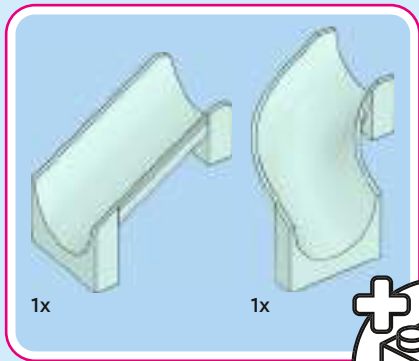

77

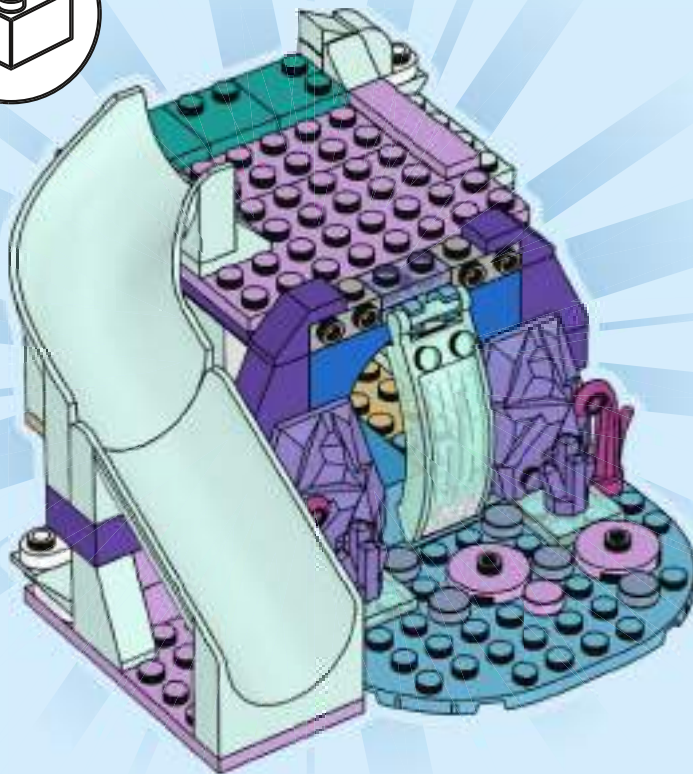



78

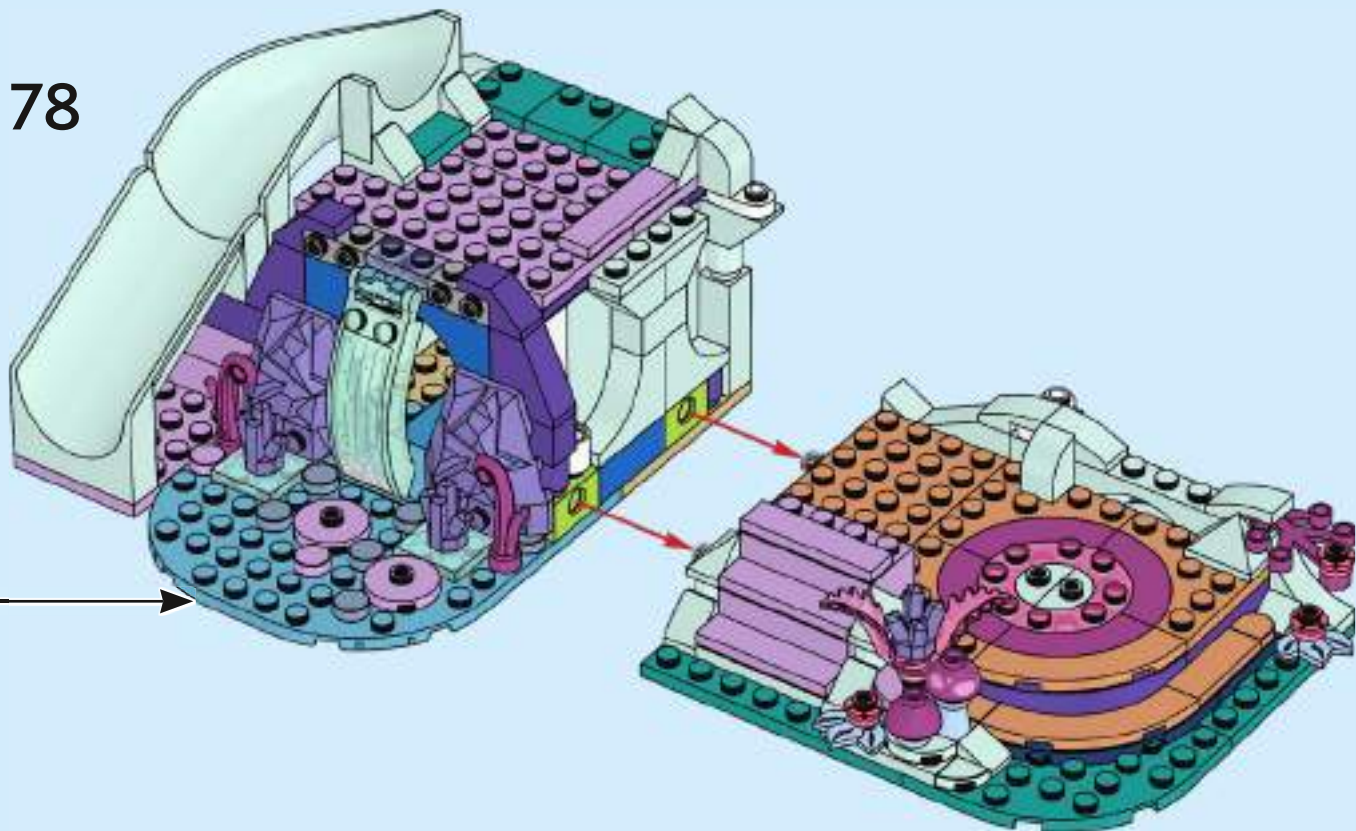



1x

79

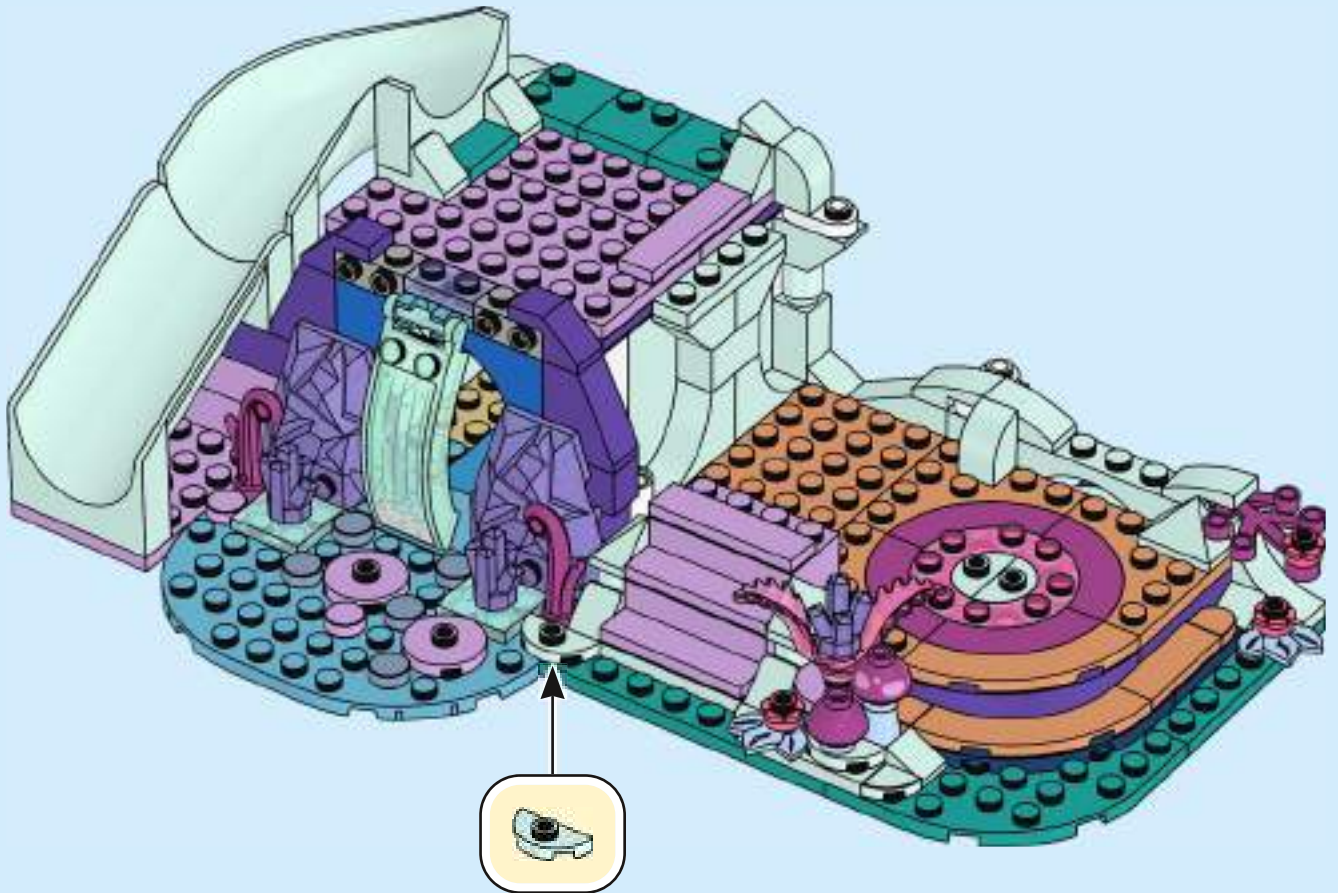



1x



1x

80

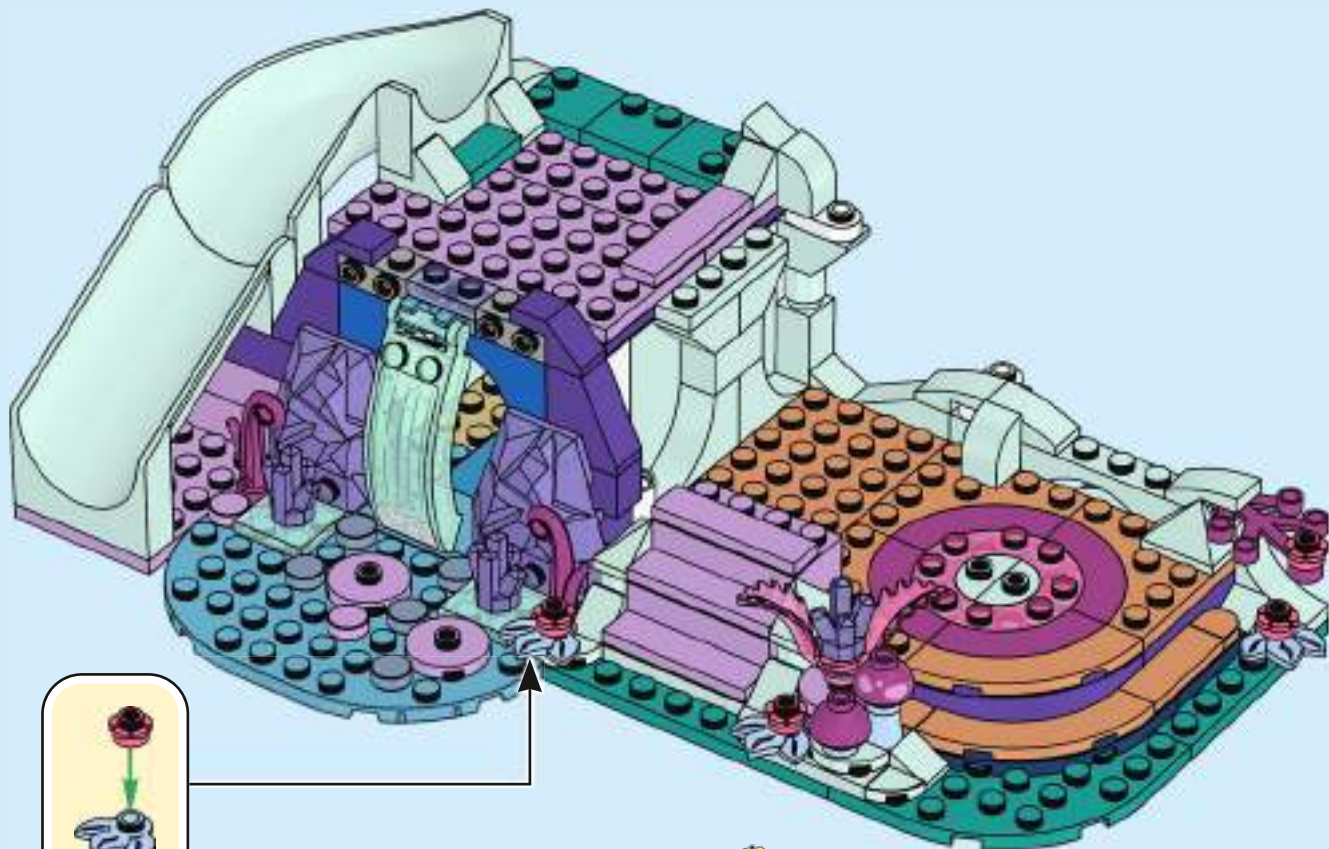

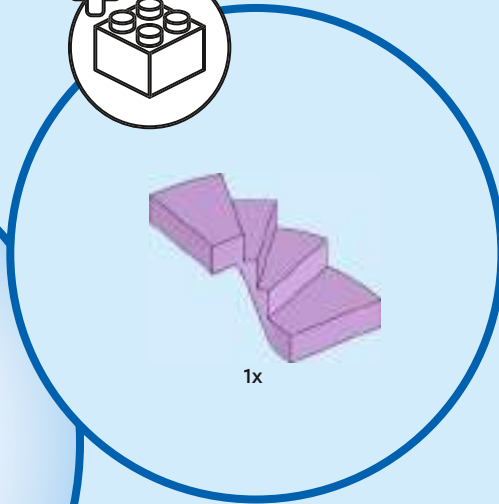
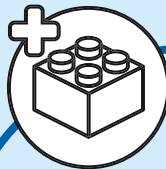



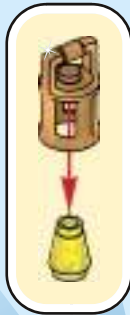
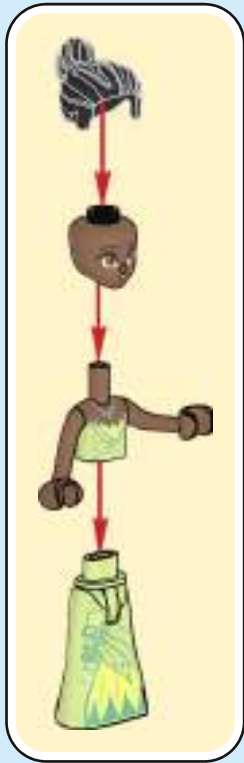



81

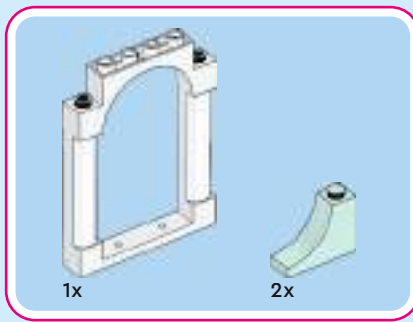

82

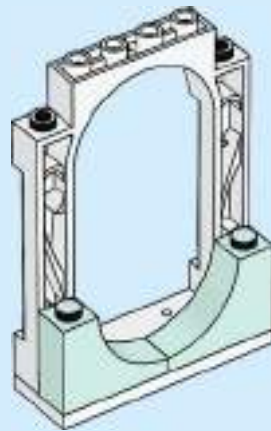





83

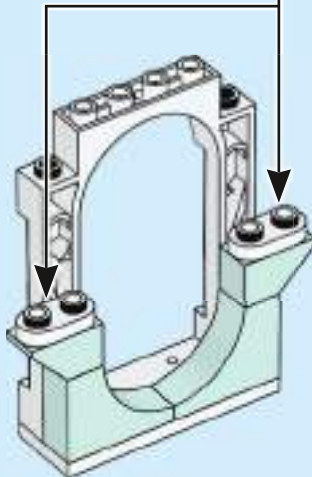
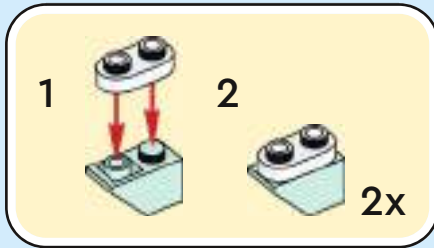

84

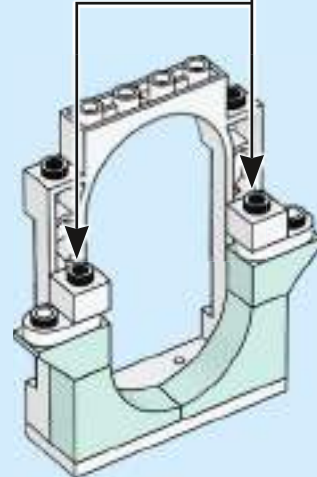
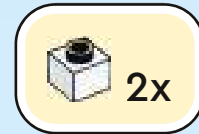

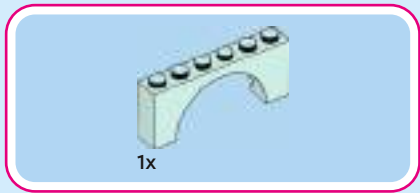

85

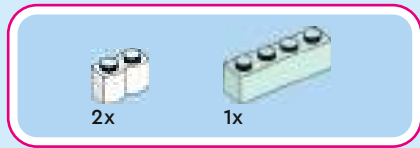
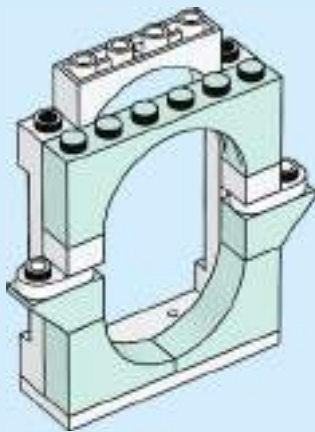

86

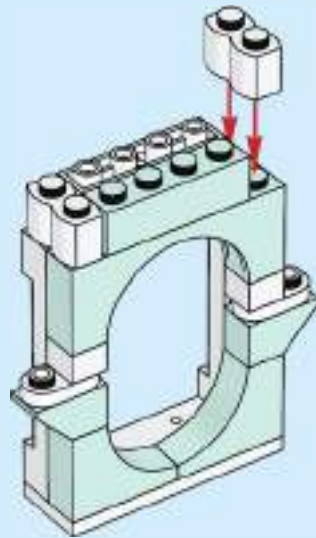



87

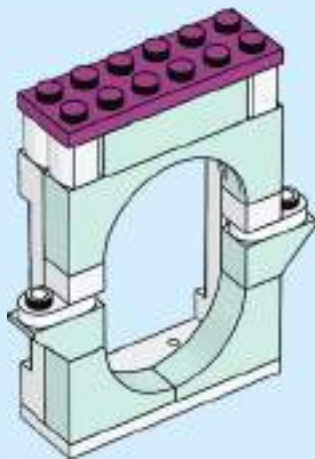

88

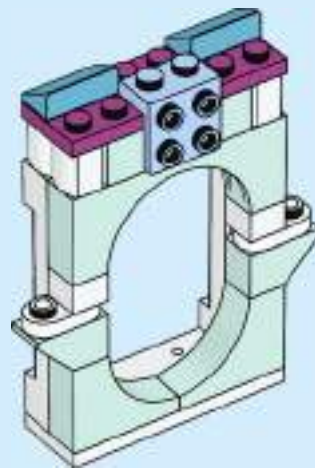



1x

89

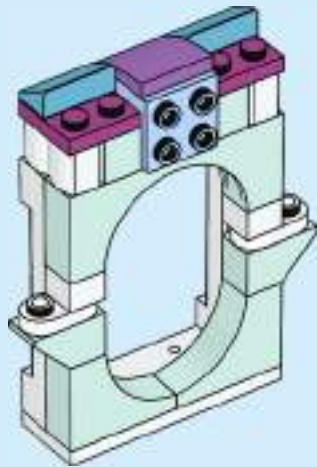

1x



1x

90

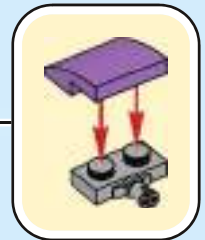
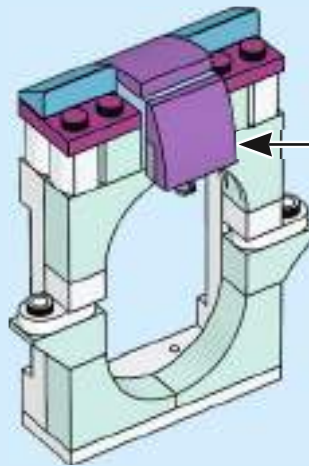



2x

91

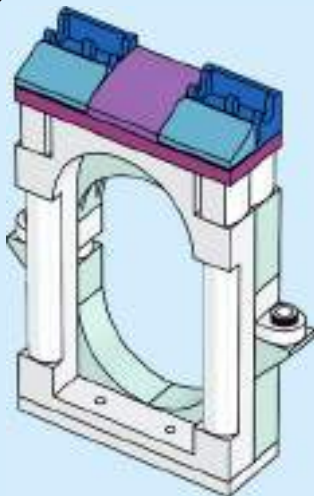

2x

92

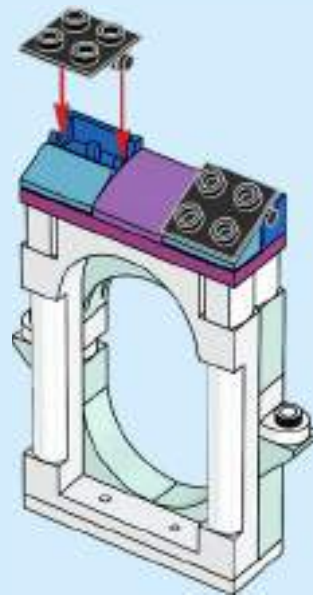

93

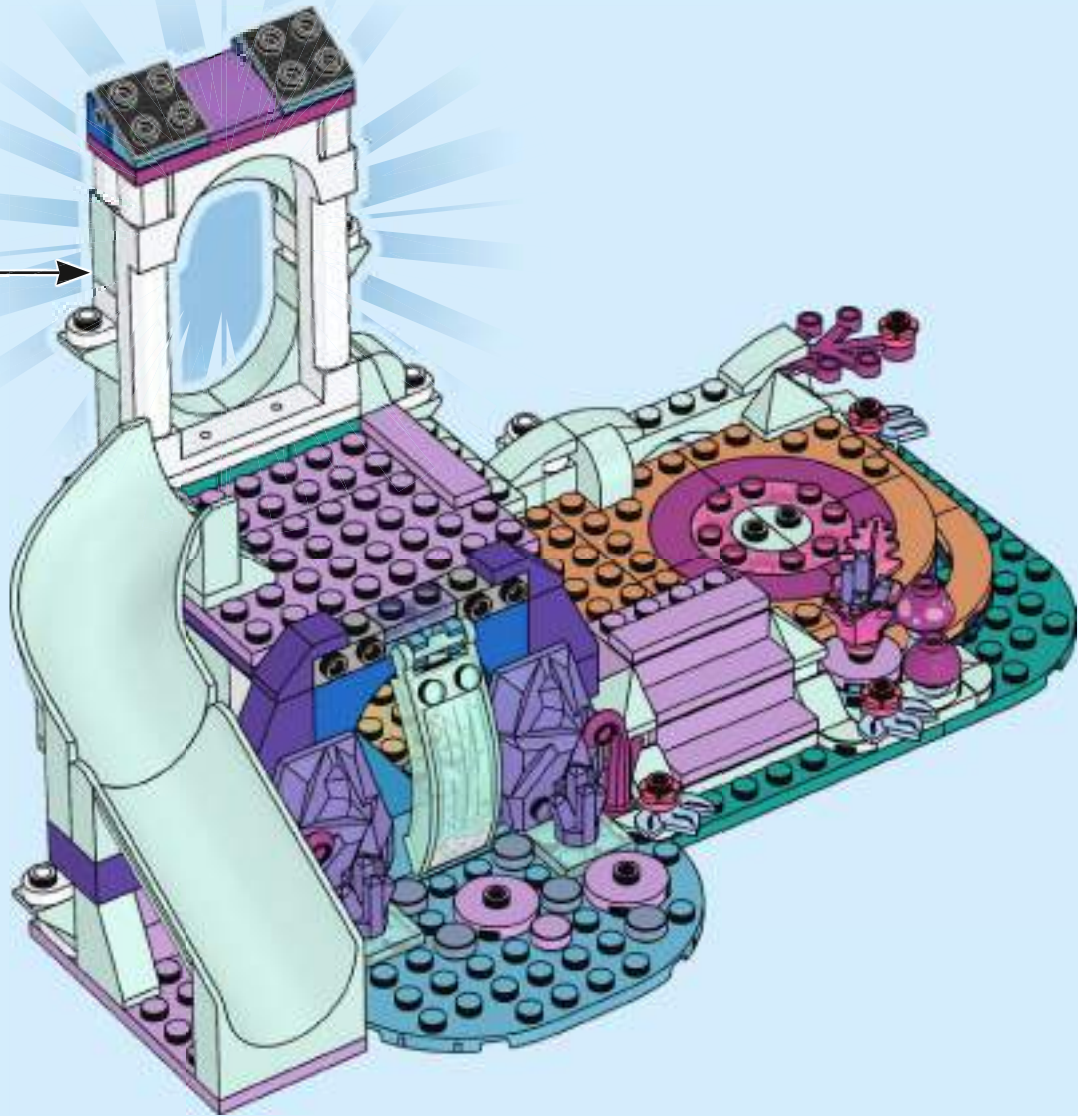





94

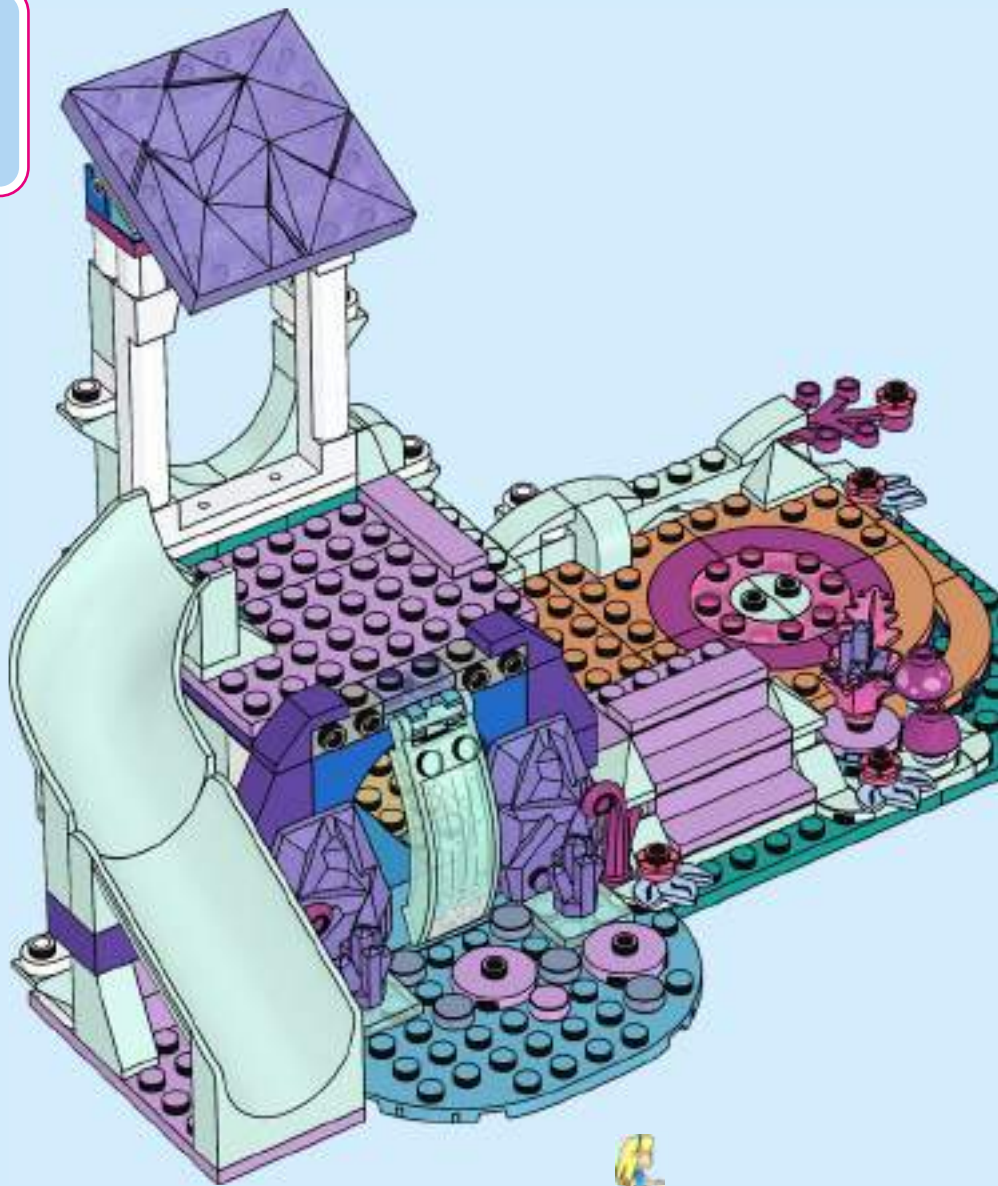

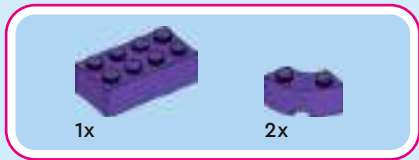

95

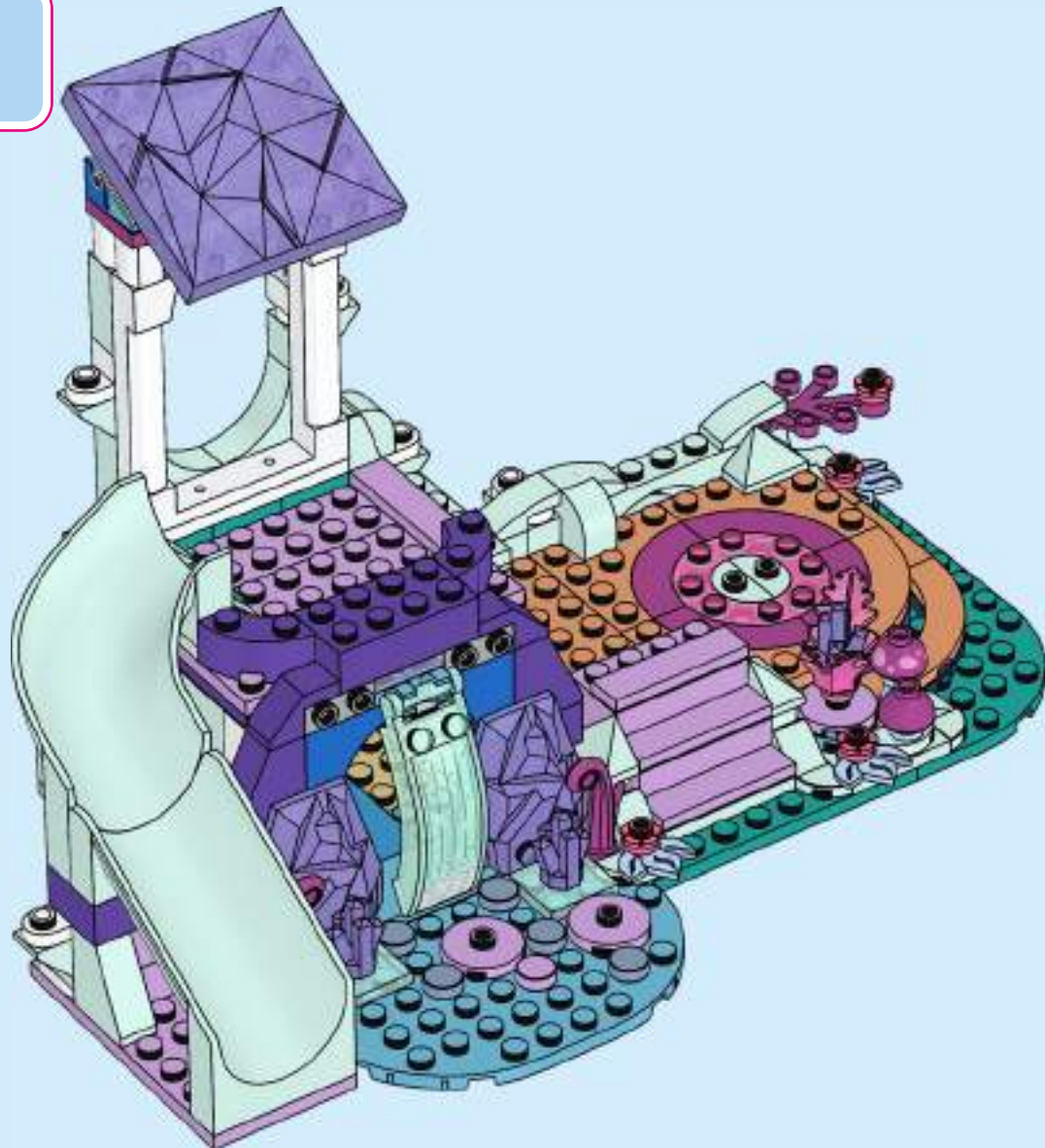



1x



2x

96

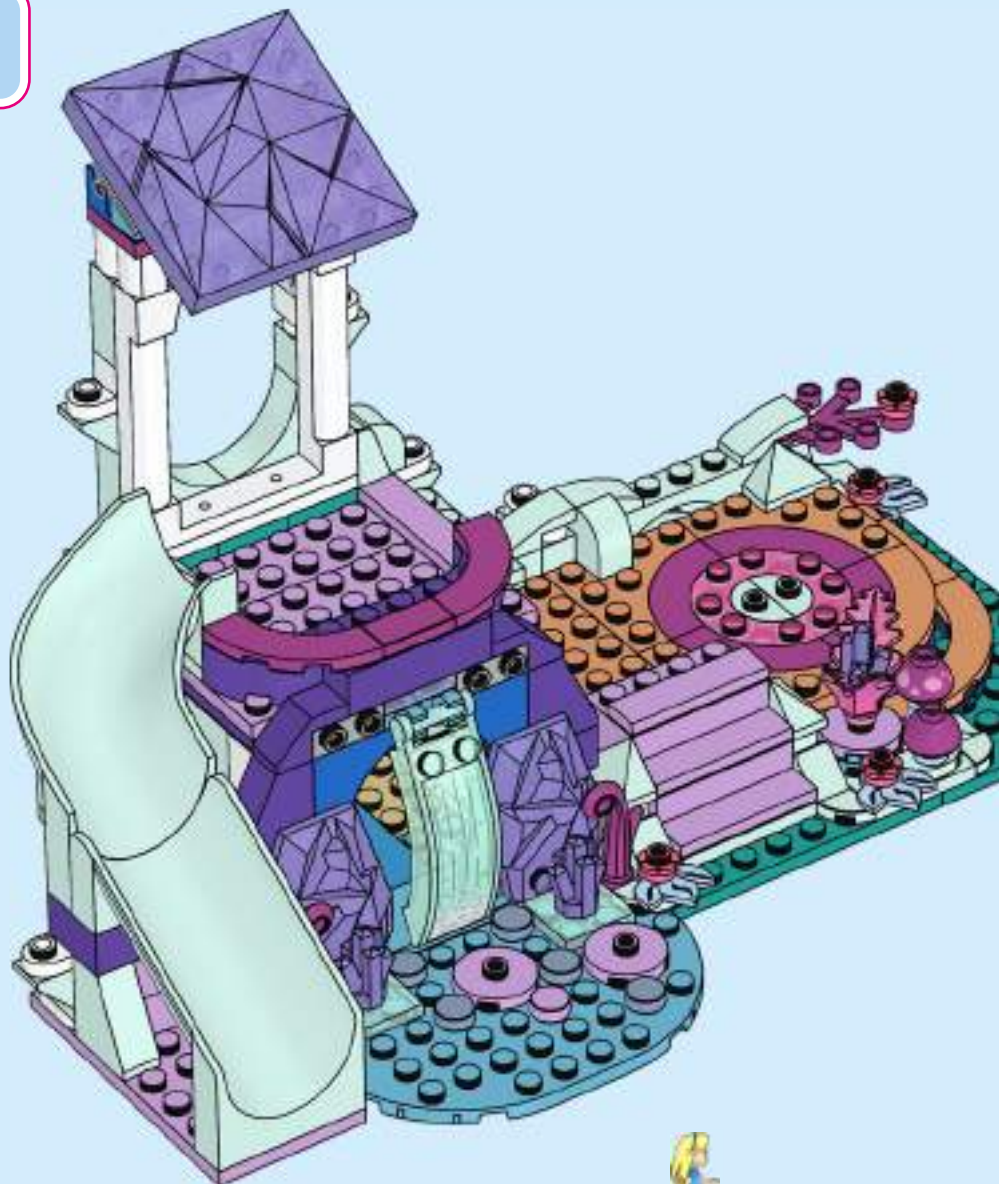





2x

97

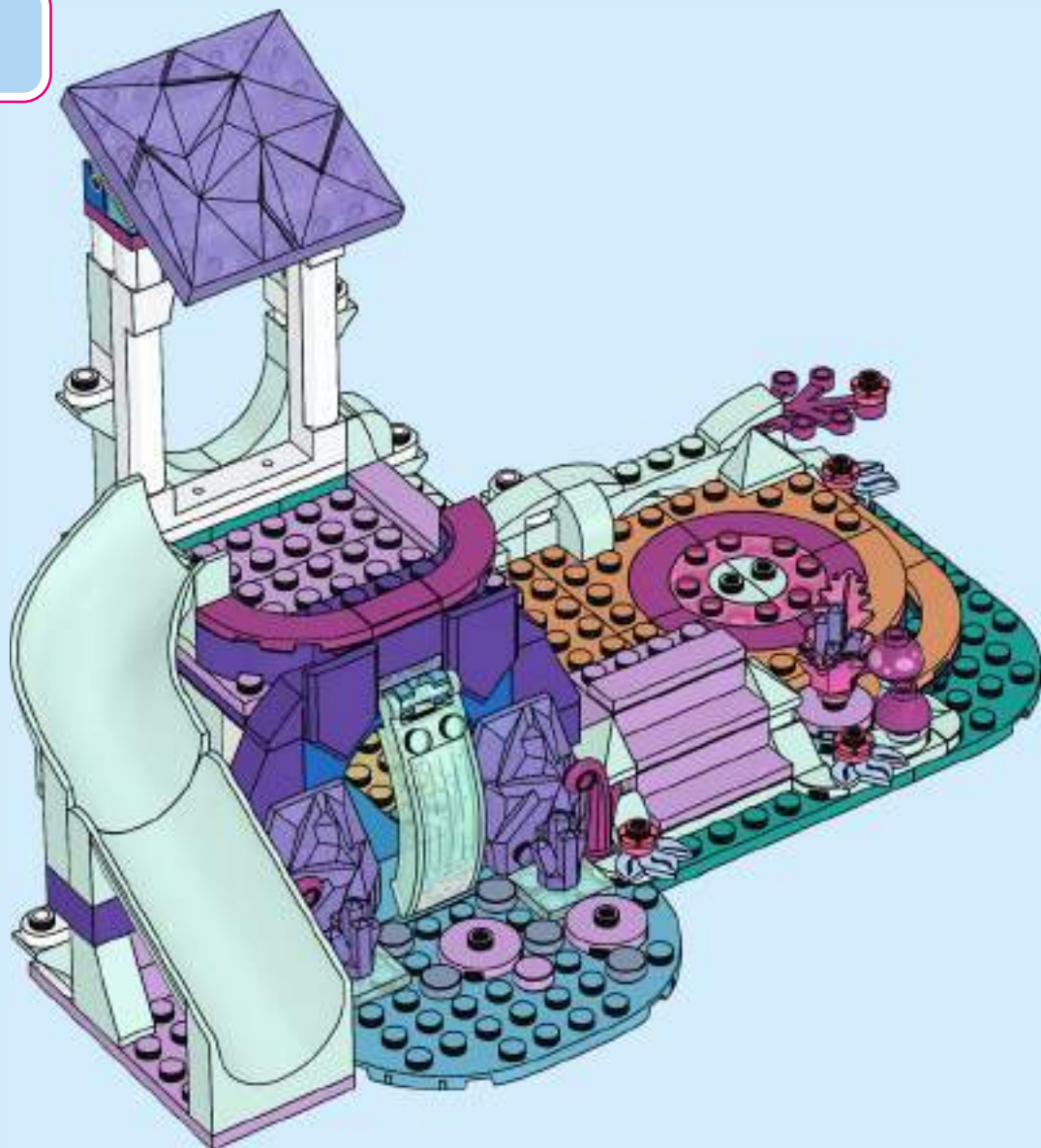

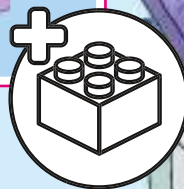
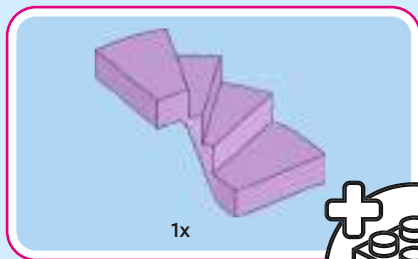

98

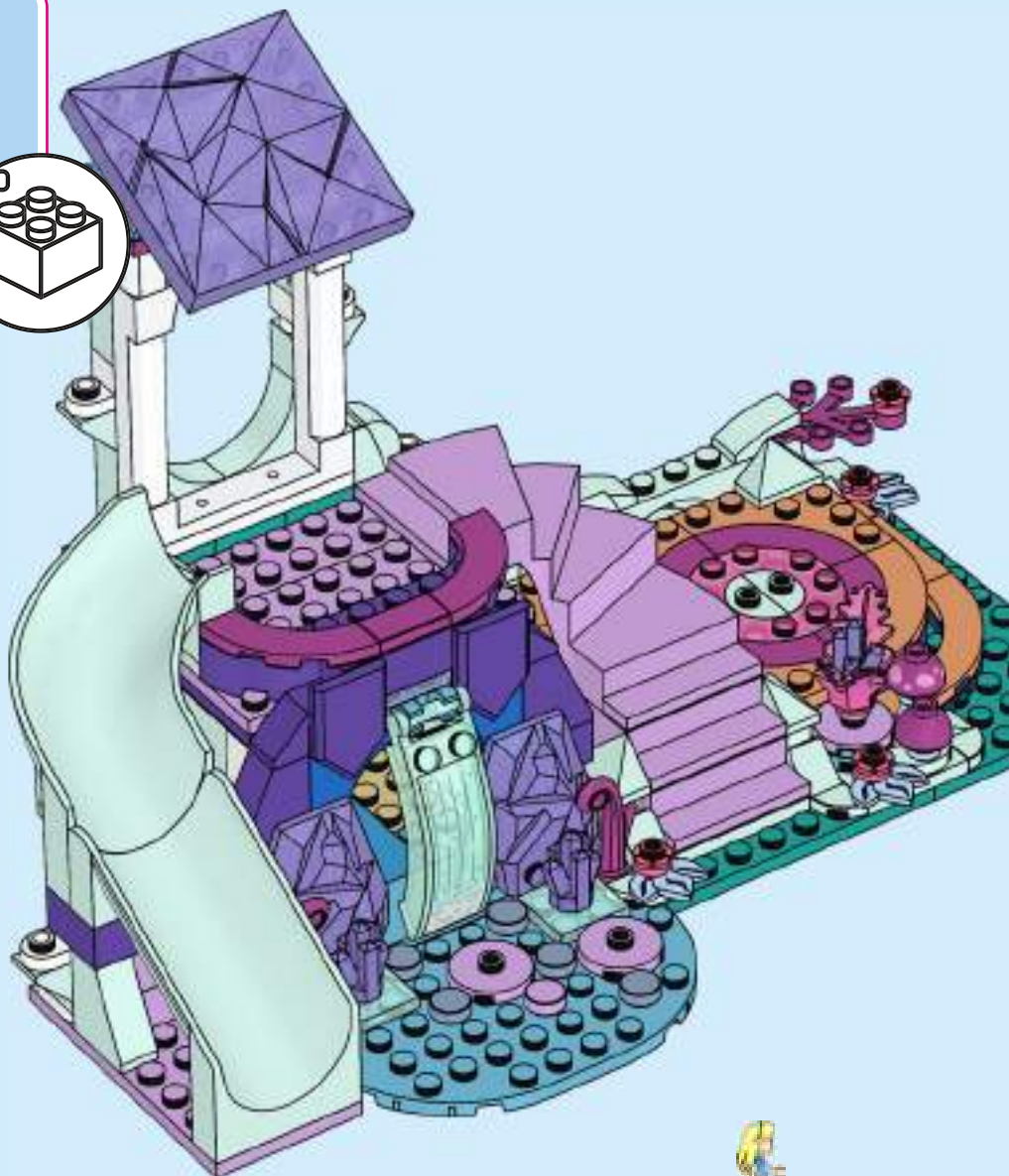



4x



99

1

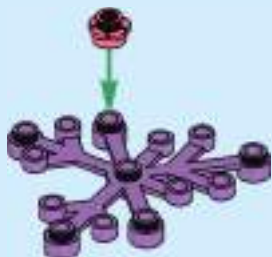

2



3

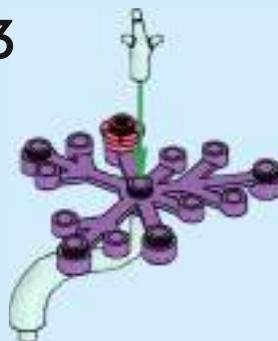

4x



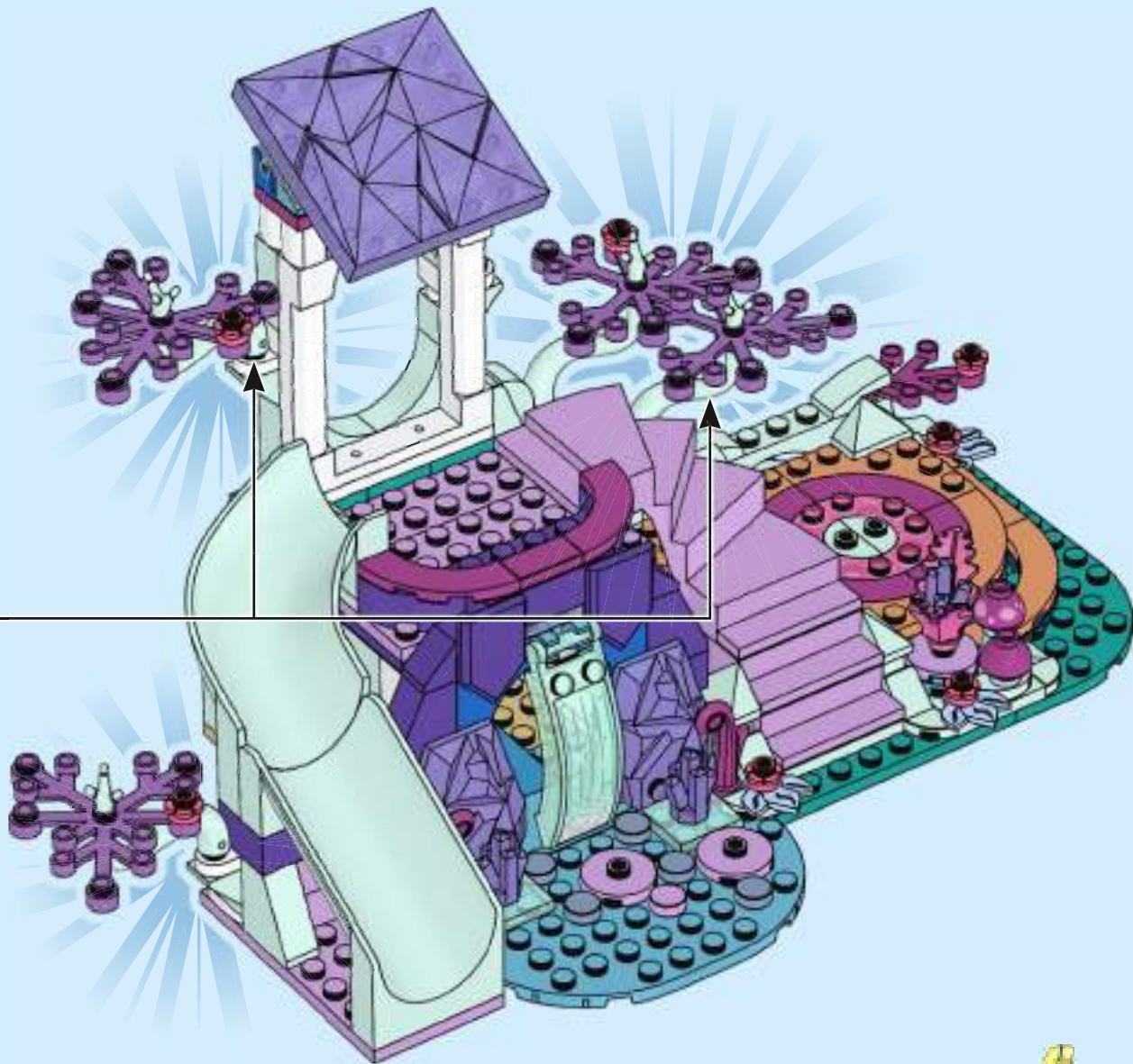



100

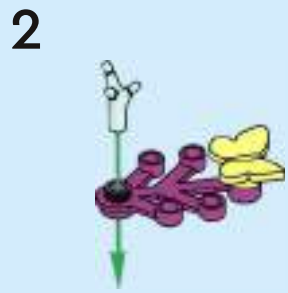
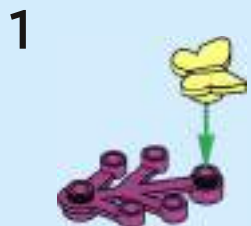

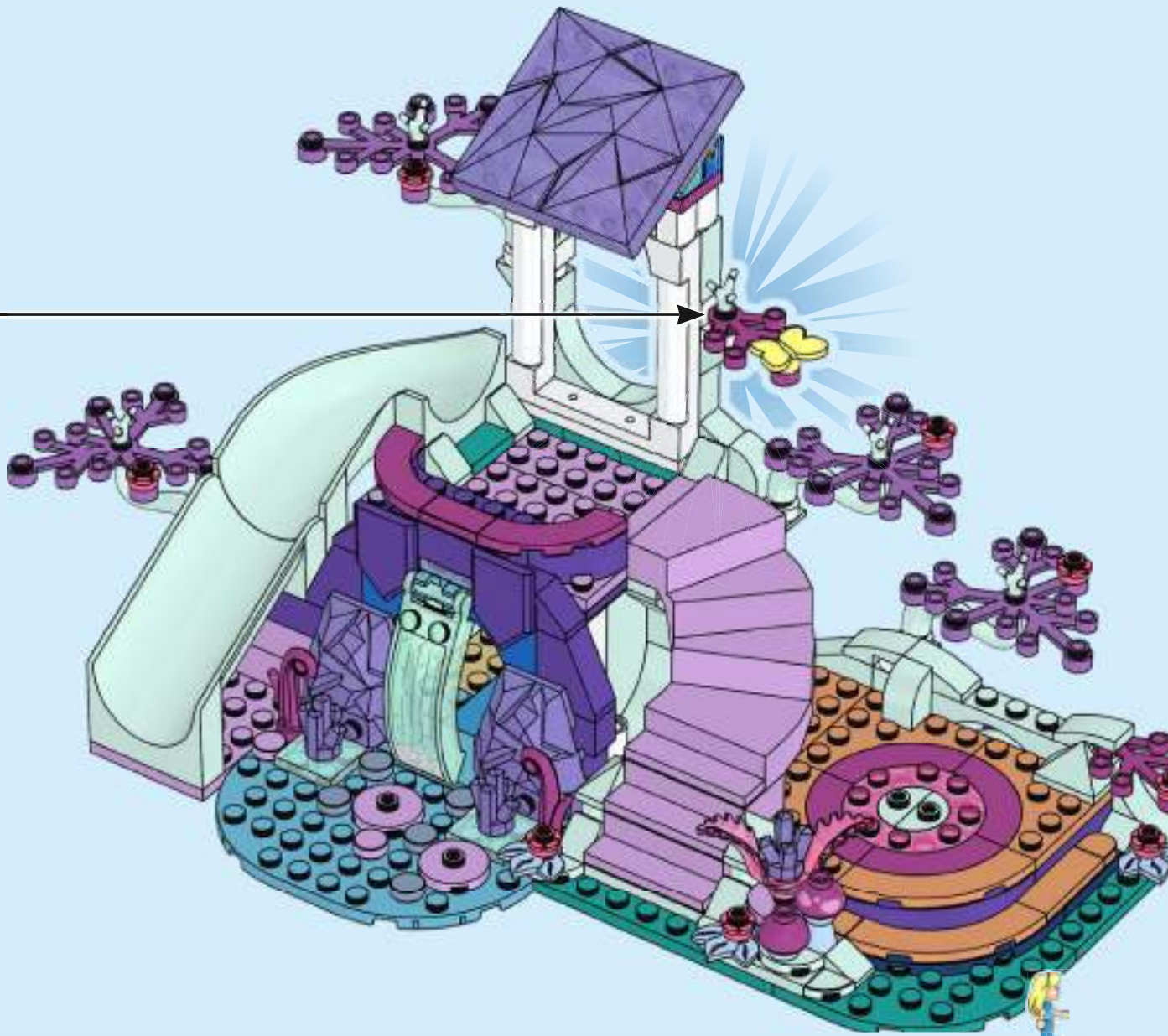



# 101

1

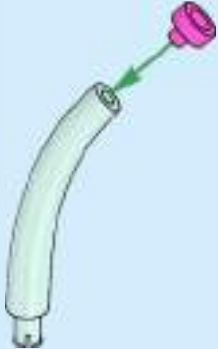

2



3

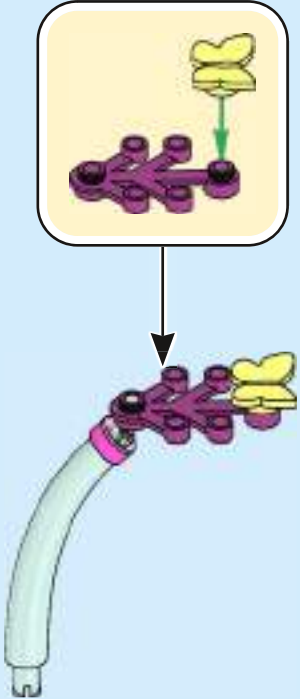



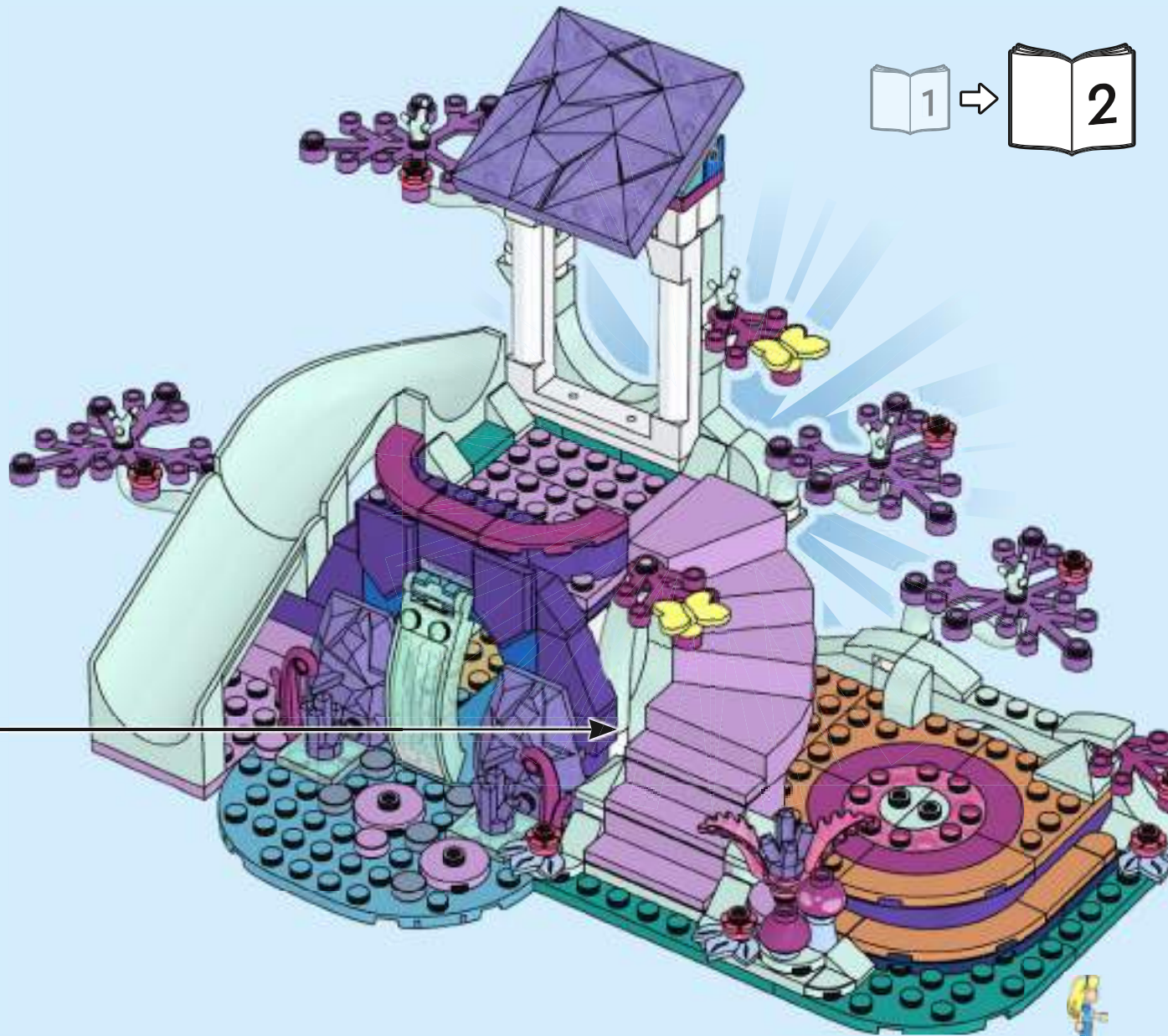
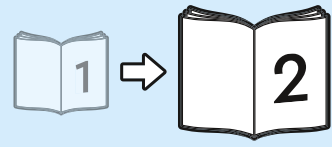

YOU COULD

WIN



Scan this QR code or go to  
**LEGO.COM/PRODUCTFEEDBACK** and give us  
your short feedback about this LEGO® set for a  
chance to win a cool LEGO prize.

Terms and Conditions apply\*

**EN: YOU COULD WIN.** Terms and Conditions apply\* **DE: Du könntest GEWINNEN.** Es gelten die Teilnahmebedingungen\* **FR: Tu pourrais GAGNER.** Des conditions s'appliquent\* **IT: Potresti VINCERE tu.** Termini e condizioni sono applicabili\* **ES: Puedes GANAR.** Aplican términos y condiciones\* **PT: Poderá GANHAR.** Aplicam-se termos e condições\* **ZH: 轻松获奖. 条款和条件适用\*** **PL: Szansa na WYGRANĄ.** Obowiązują warunki korzystania\* **CS: Máte šanci VYHRÁT.** Platí všeobecné smluvní podmínky\* **SK: Máte šancu VYHRAŤ.** Platia všeobecné zmluvné podmienky\* **HU: TE IS NYERHETSZ.** Felhasználási feltételek érvényesek\* **RO: Ai putea CÂȘTIGA.** Se aplică termeni și condiții\* **BG: Можете да СПЕЧЕЛИТЕ.** Има определени правила и условия\* **LV: Tu vari LAIMĒT.** Ir spēkā noteikumi un nosacījumi.\* **ET: Sul on võimalus VÕITA.** Kehtivad tingimused\* **LT: Jūs galite LAIMĖTI.** Taikomos sąlygos\*

\*[LEGO.com/productfeedback-terms](https://www.lego.com/productfeedback-terms)

LEGO and the LEGO logo are trademarks of the LEGO Group. ©2023 The LEGO Group. ©Disney

6493764