



Friends

41748



1



[LEGO.com/sustainable-packaging](https://LEGO.com/sustainable-packaging)



# BUILDER



Apple and the Apple logo are trademarks of Apple Inc., registered in the U.S. and other countries and regions. App Store is a service mark of Apple Inc. Google Play and the Google Play logo are trademarks of Google LLC. Tencent and the Tencent logo are trademarks of Tencent Inc.

Q [LEGO.com/devicecheck](https://www.lego.com/devicecheck)

EN Ask parents' permission before going online | DE Eltern um Erlaubnis bitten, bevor du online gehst | FR Demande l'autorisation d'un parent avant d'aller en ligne | IT Chiedi il permesso ai tuoi genitori prima di andare online | ES Pídeles permiso a tus papás antes de conectarte a Internet | PT Peça autorização aos pais antes de acederes online | ZH 上网前应先征得父母的同意 | PL Poproś rodziców o zgodę, zanim wejdiesz do Internetu | CS Než půjdeš na internet, požádej rodiče o svolení | SK Skôr než pôjdeš na internet, vypýtaj si povolenie od rodičov | HU Kérj szülői engedélyt, mielőtt online csatlakoznál! | RO Cere permisiunea părinților înainte de a te conecta online | BG Поискайте разрешение от родител, преди да влезете онлайн | LV Pirms došanās tiešsaistē palūdz atļauju vecākiem | ET Enne Interneti kasutamist küsi vanematelt luba | LT Prieš prisijungdami prie interneto, atsiklauskite tėvų

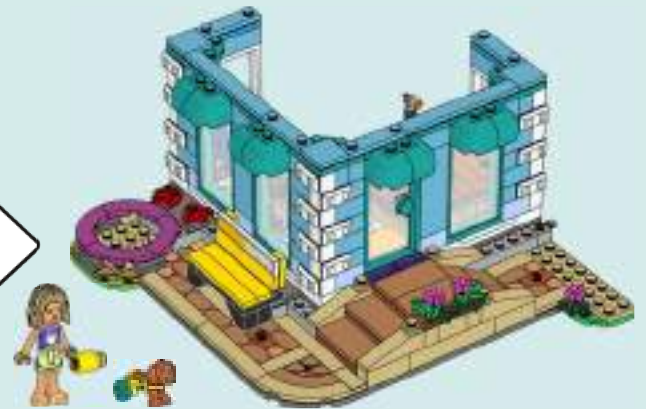
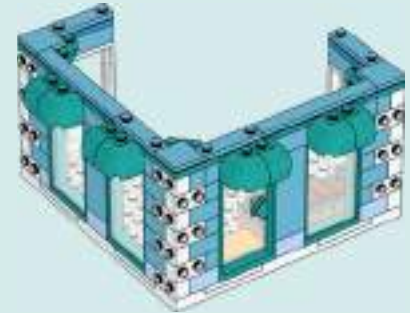
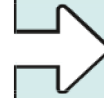
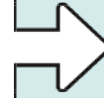
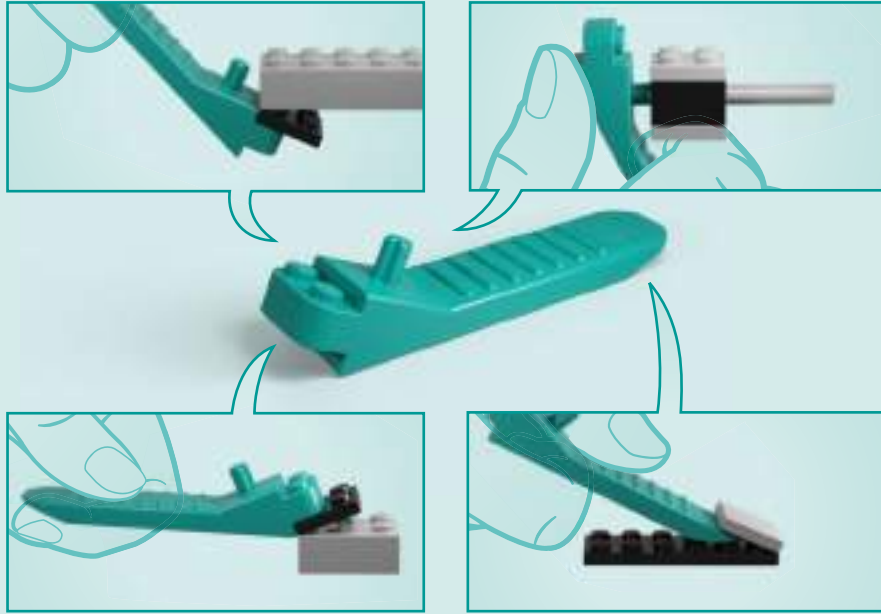



# PAISLEY

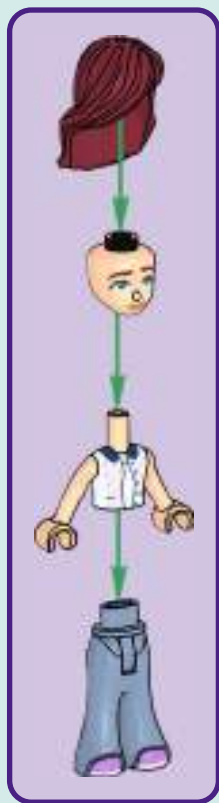



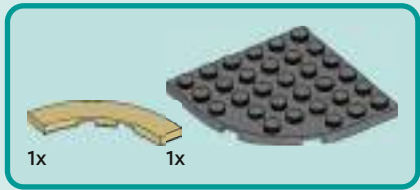
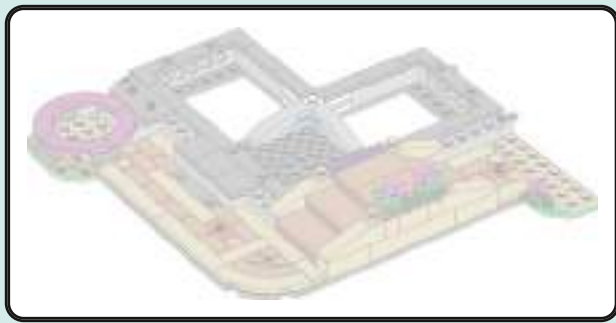

1

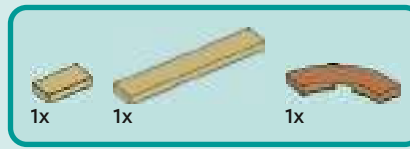

2

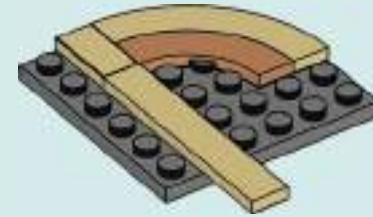

3

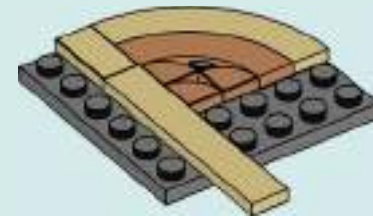





4



5

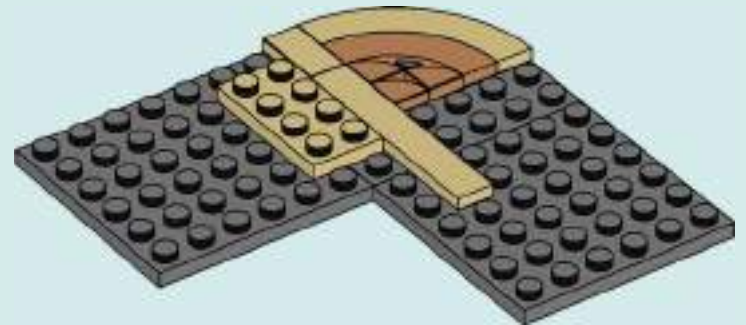

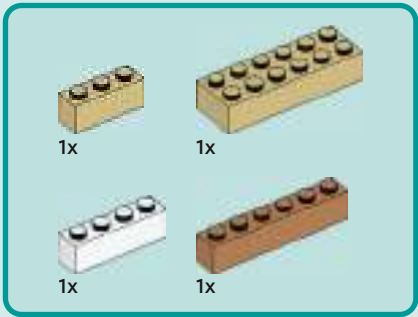

6

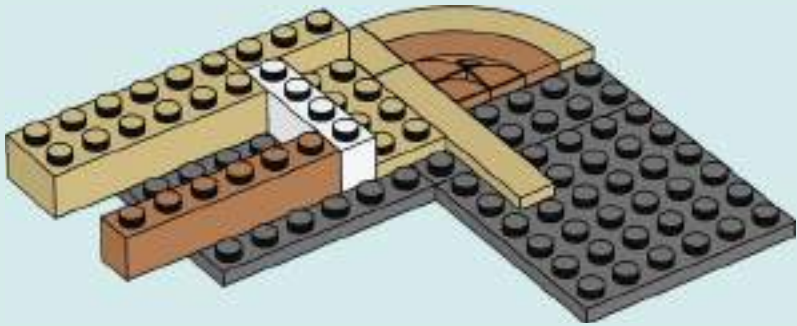

7

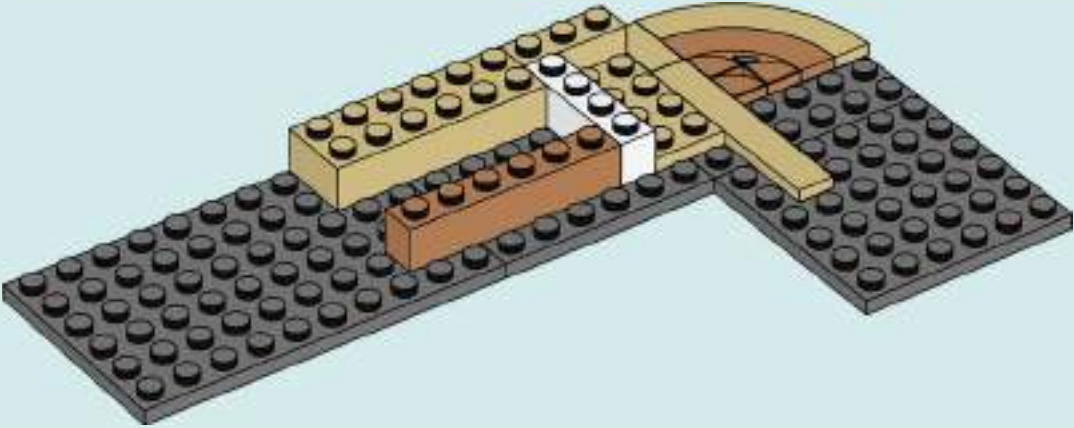





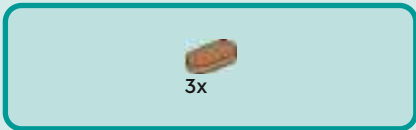

12

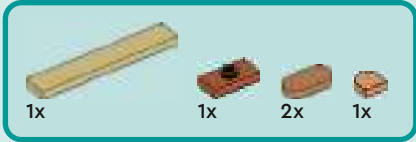
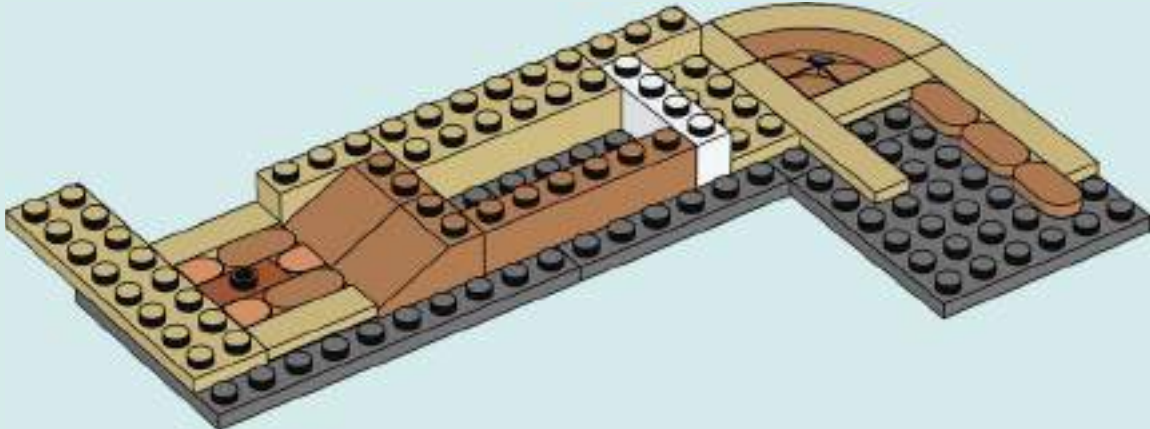

13

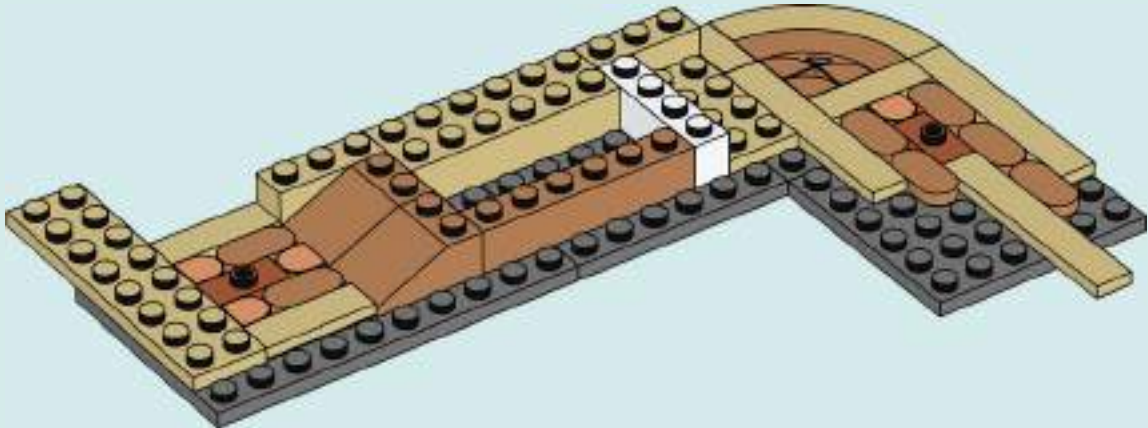



14

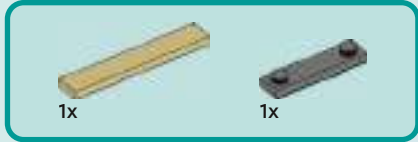
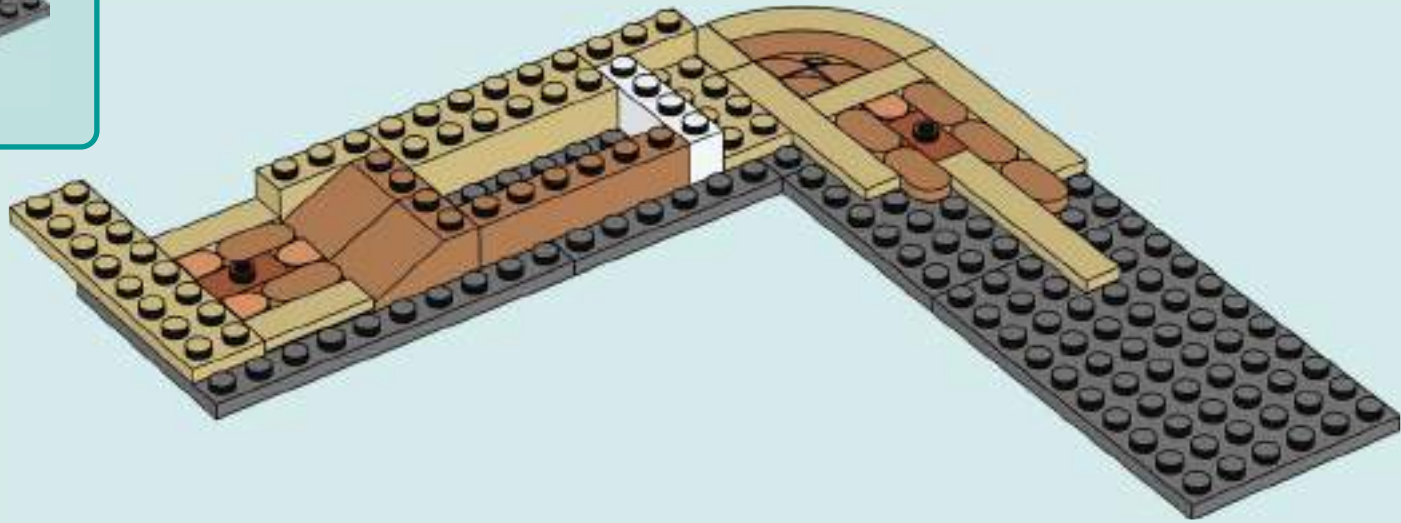

15

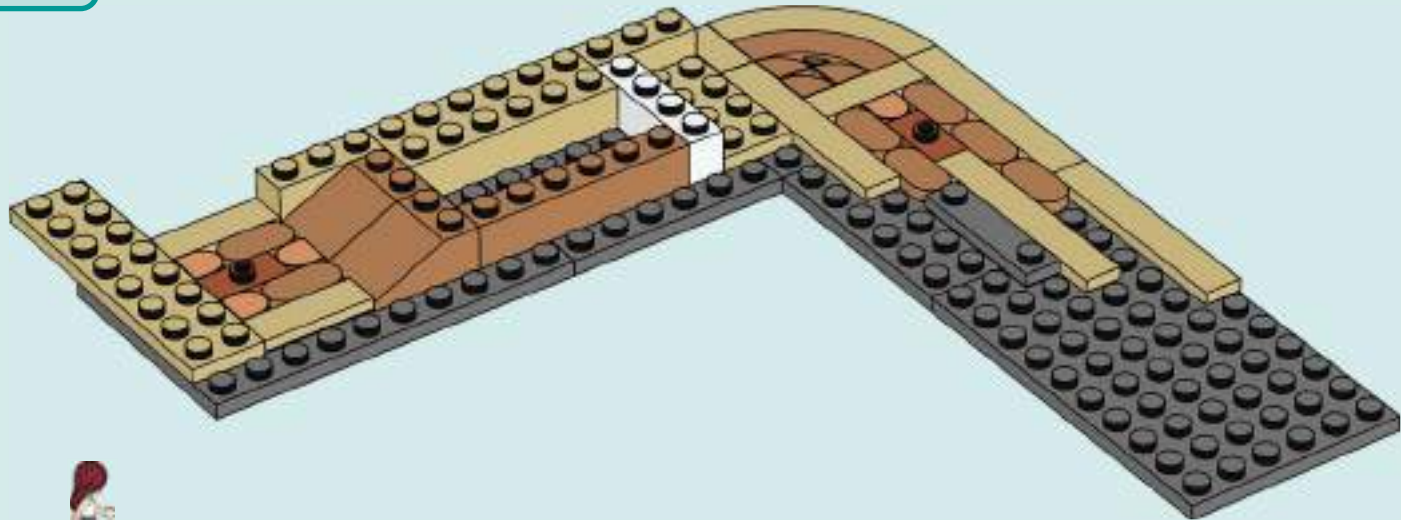



16

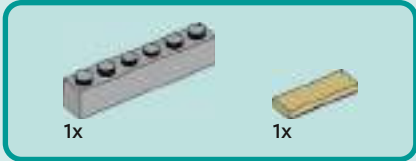
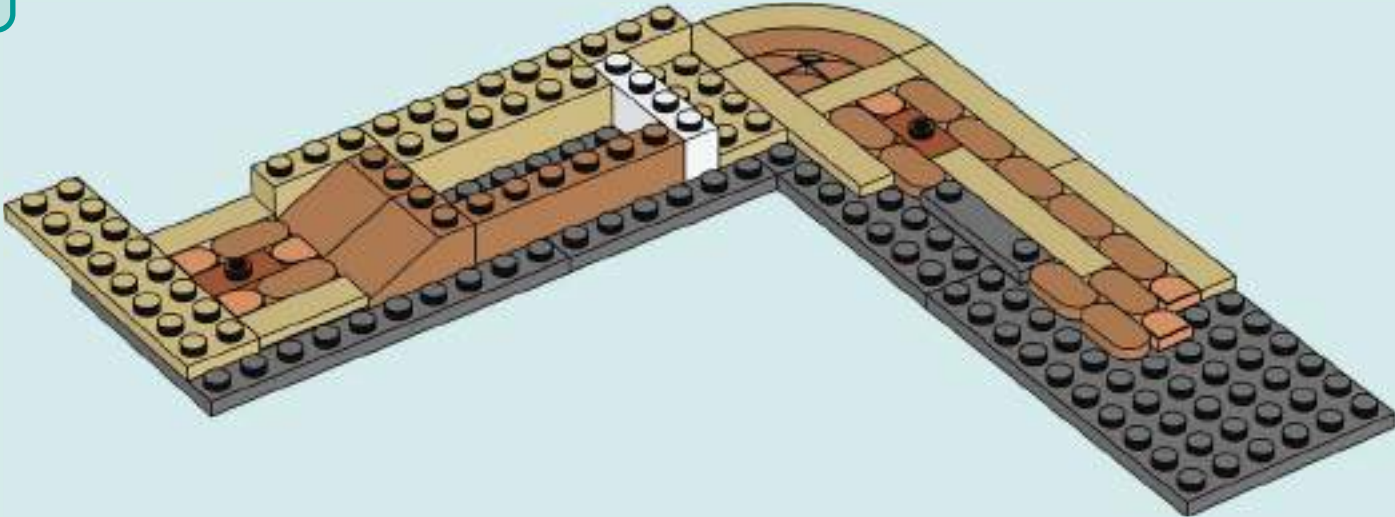

17

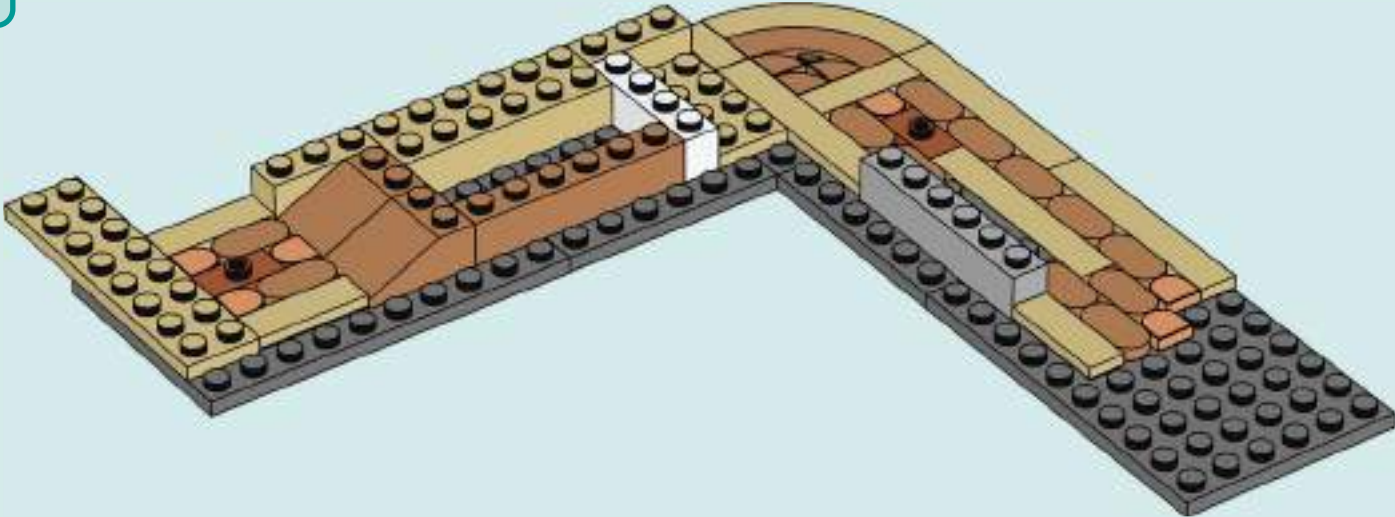



2x



2x

18

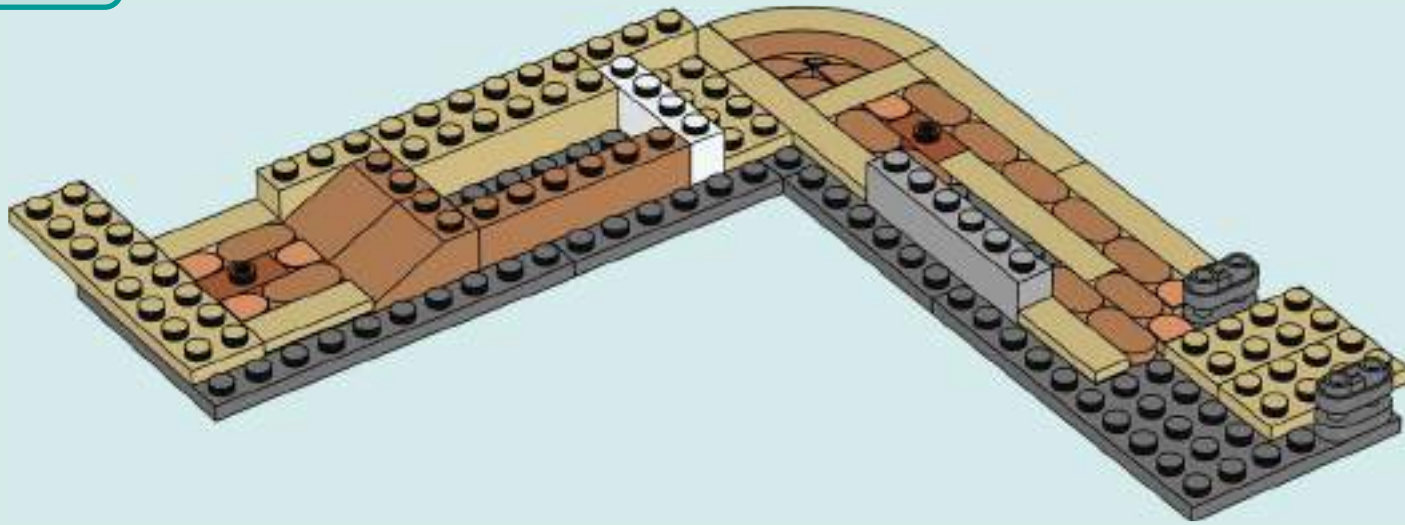

1x



1x

19

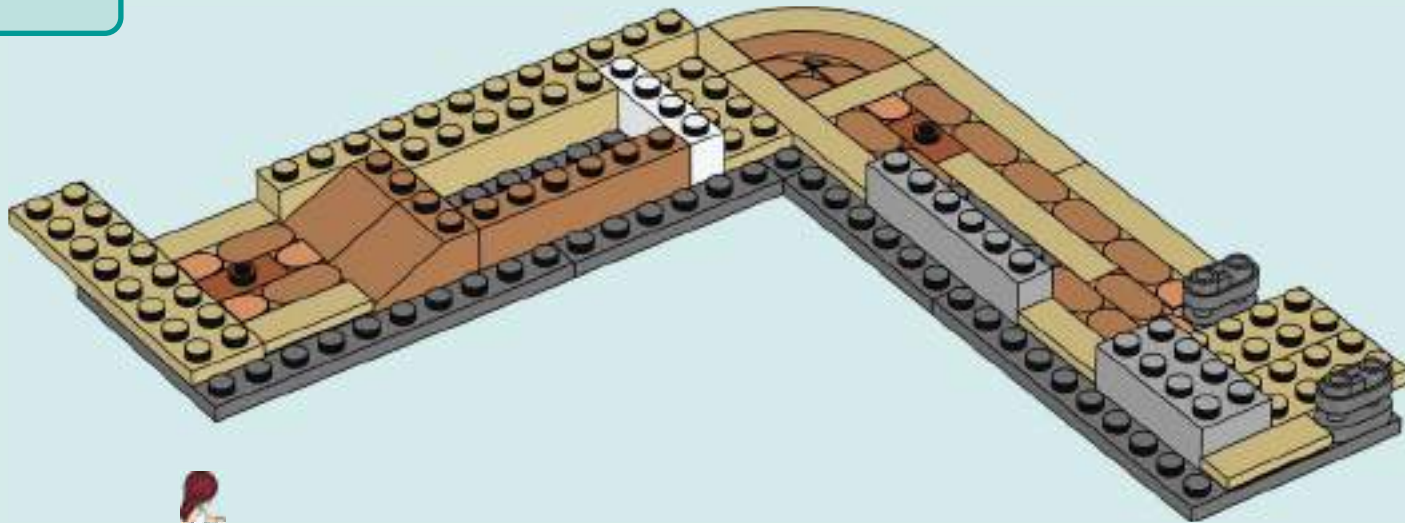



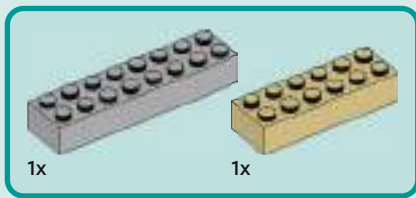

20

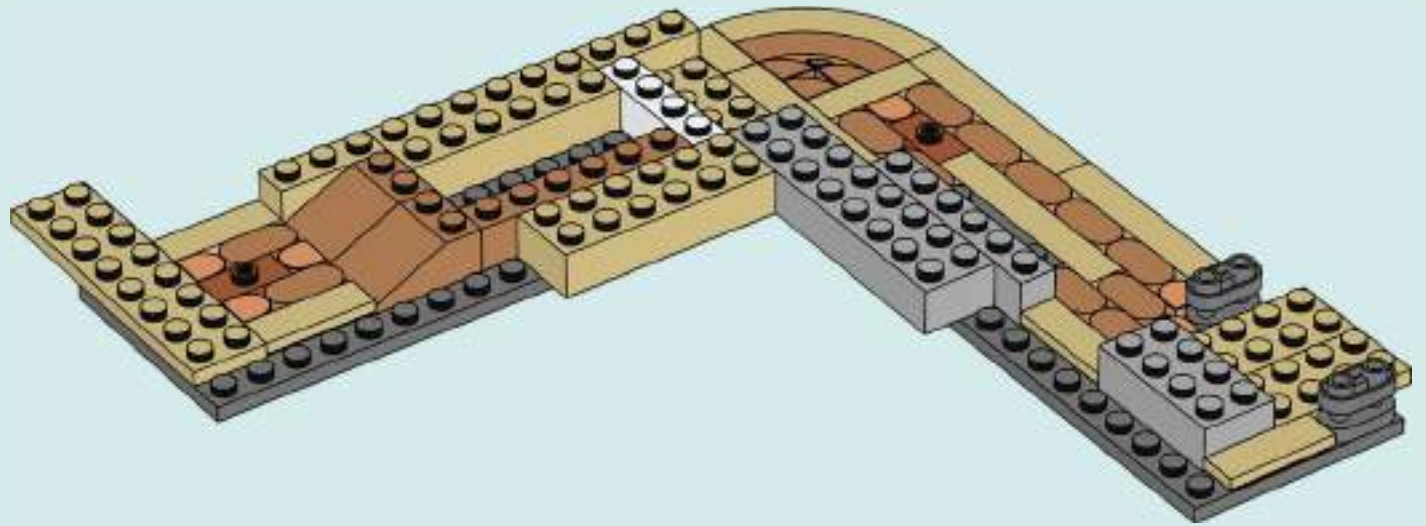

21

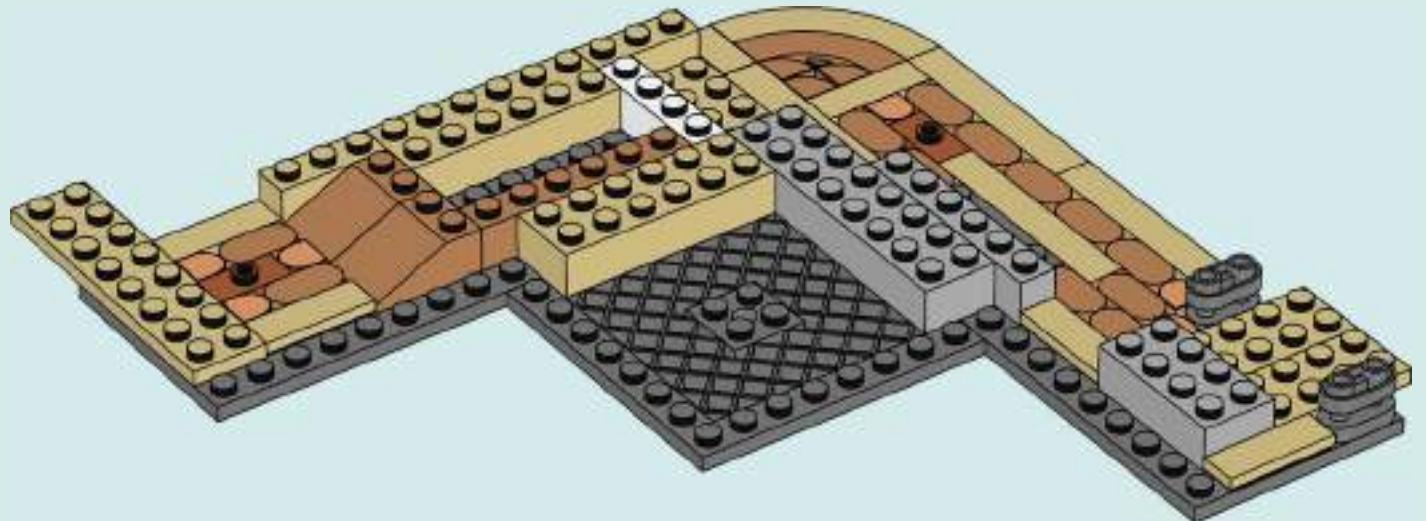



22

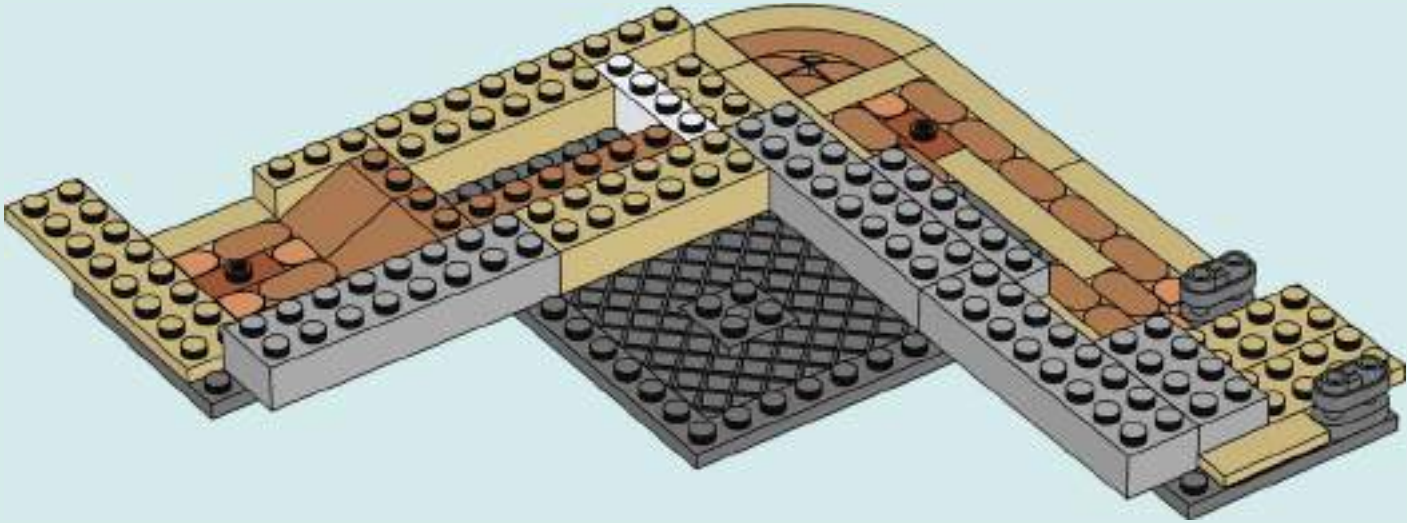



23

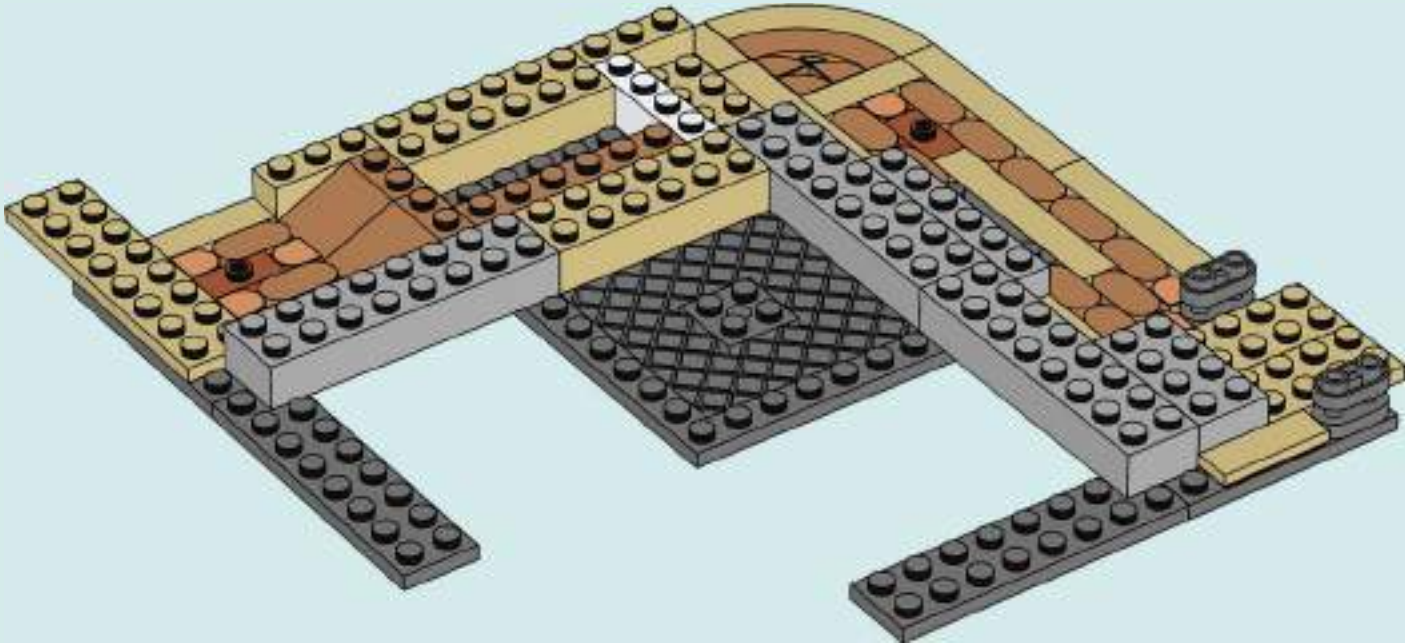



24

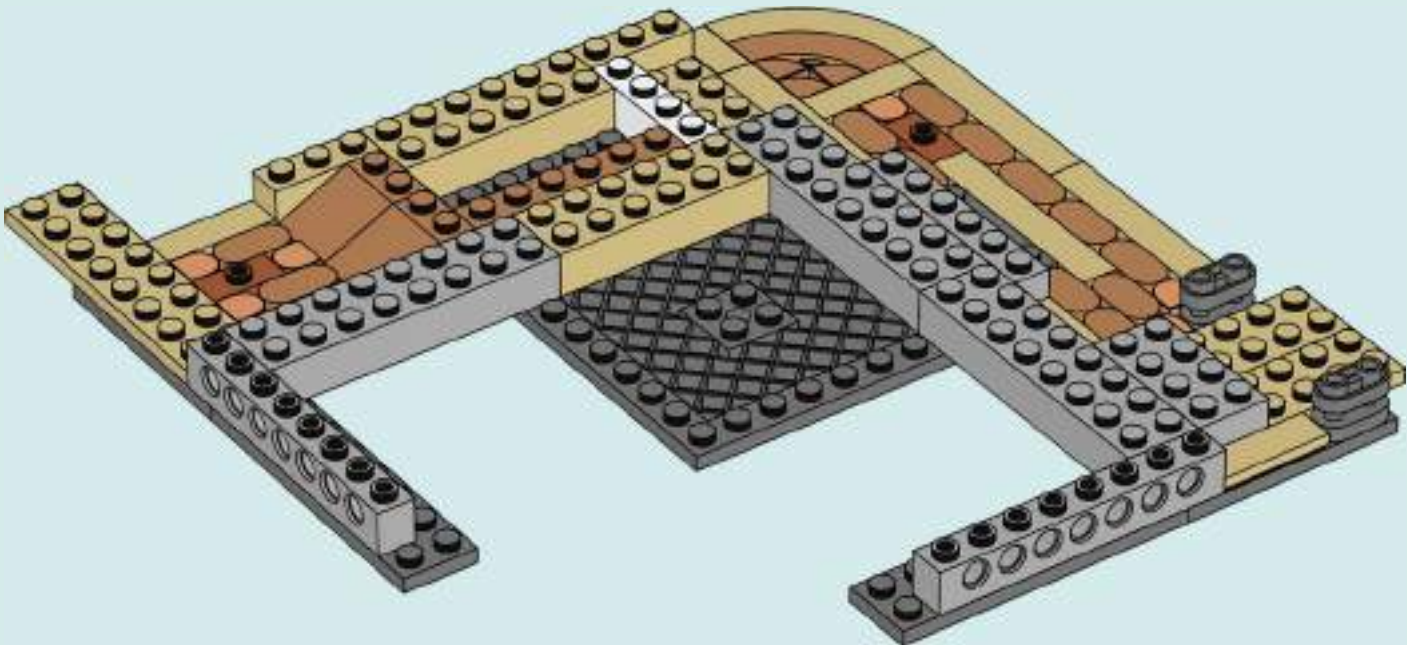





2x



1x

# 26

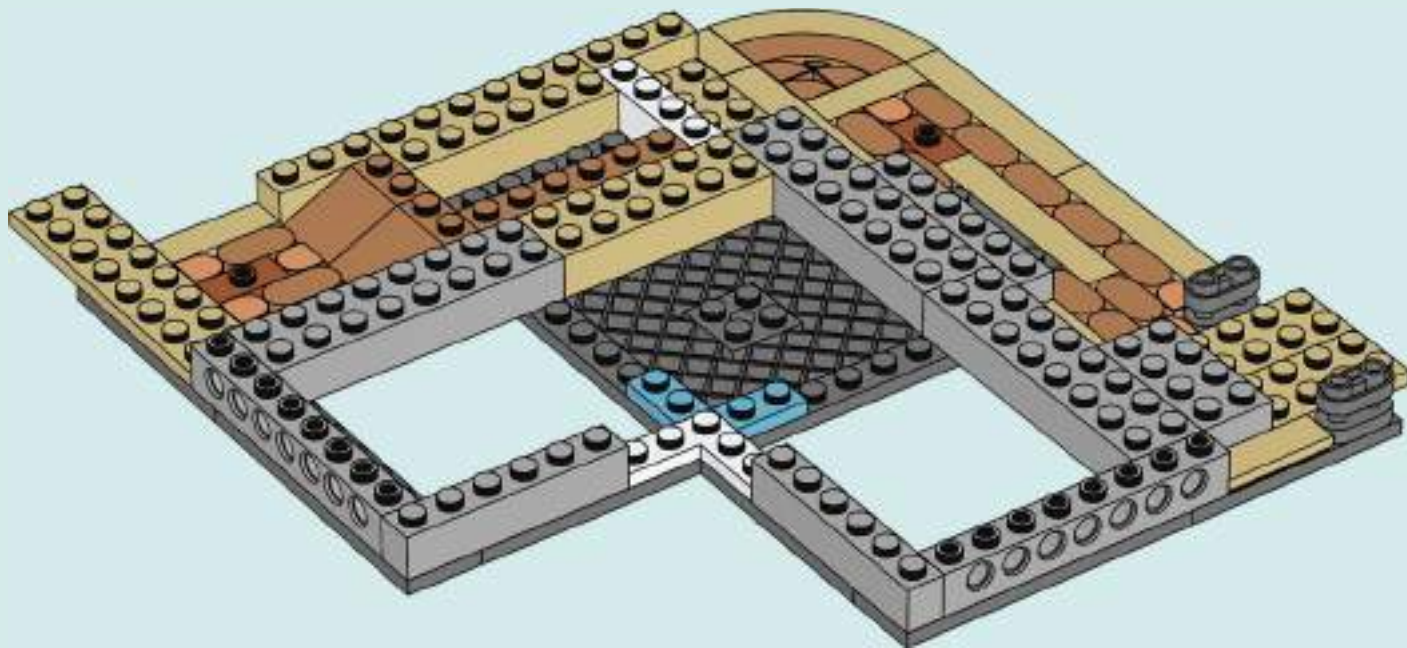

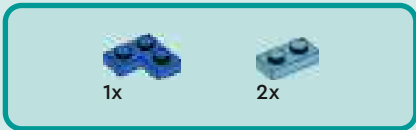

27

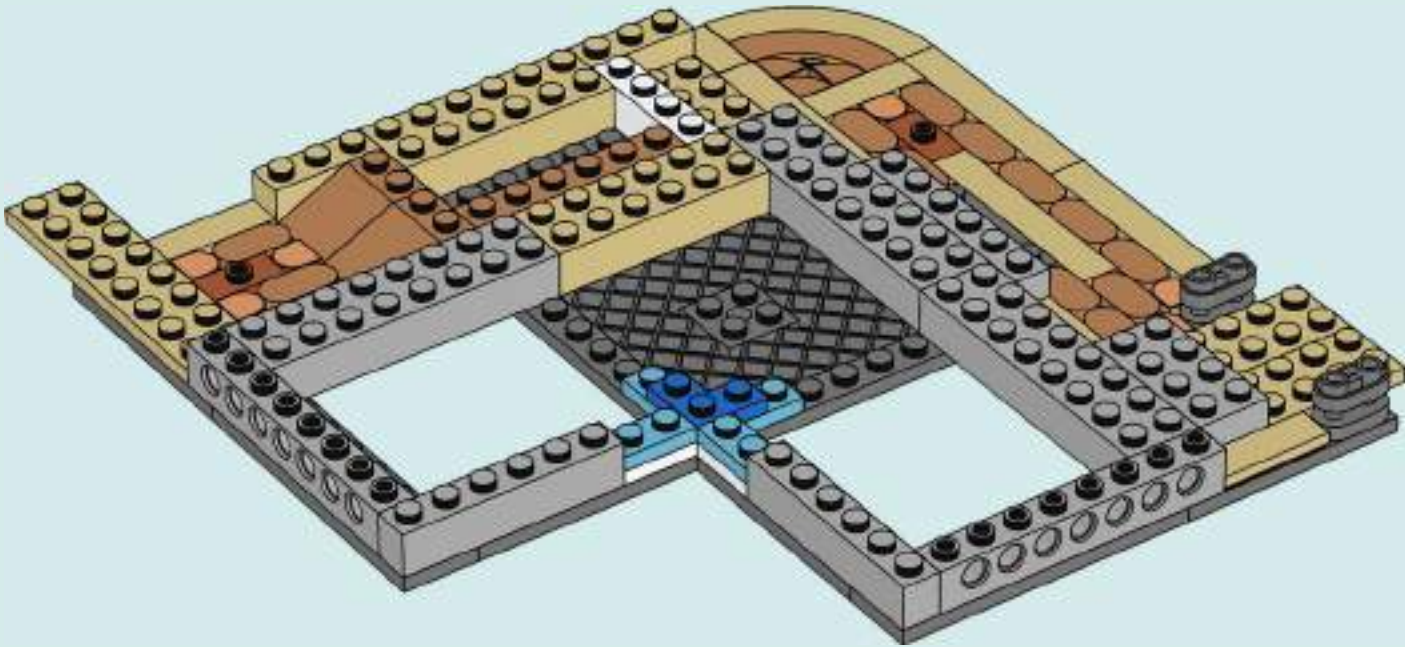

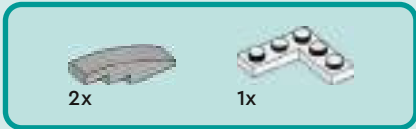

28

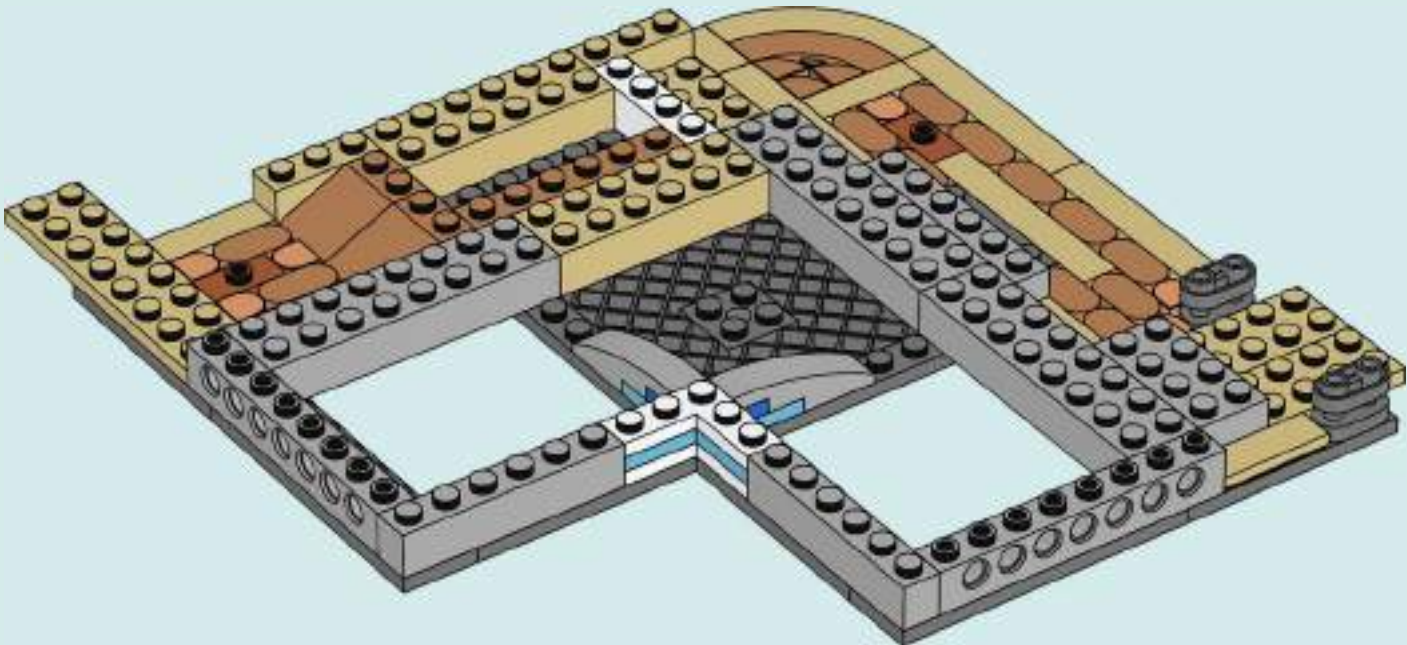



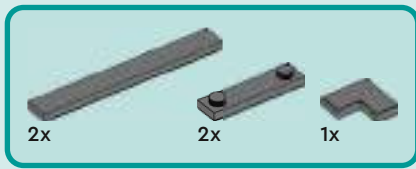

29

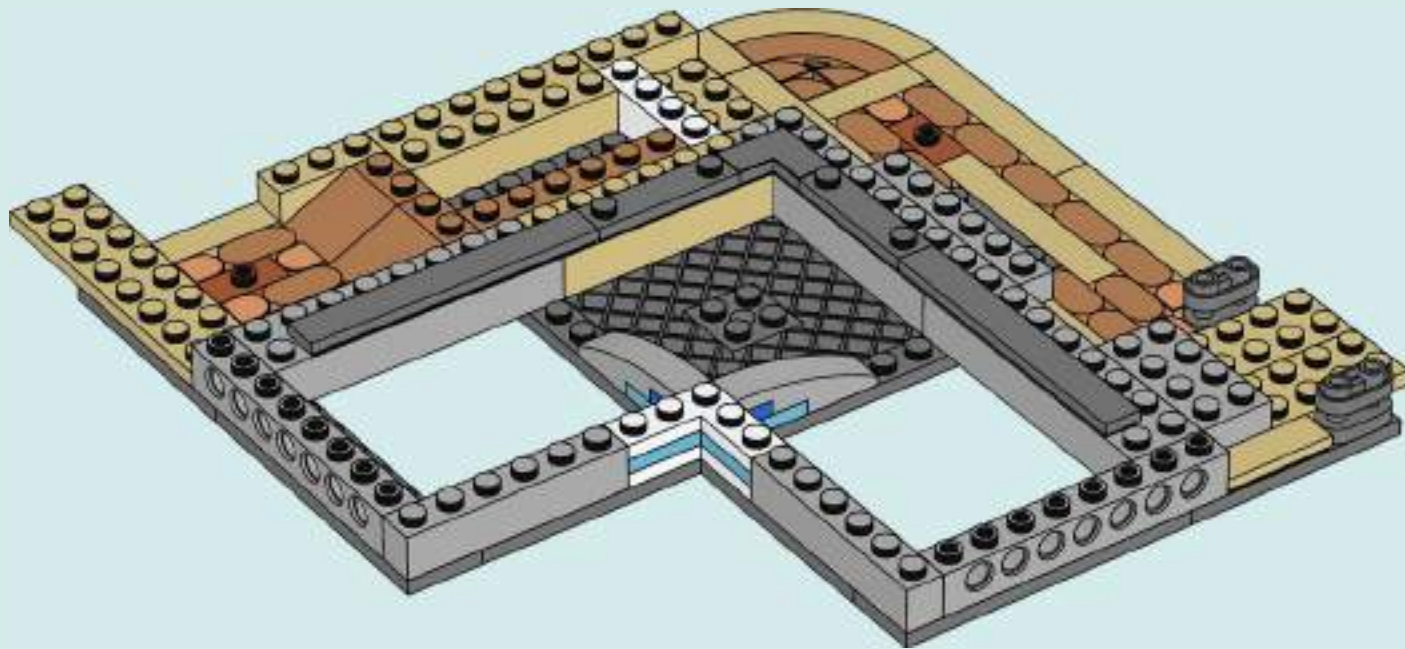



4x



2x

30

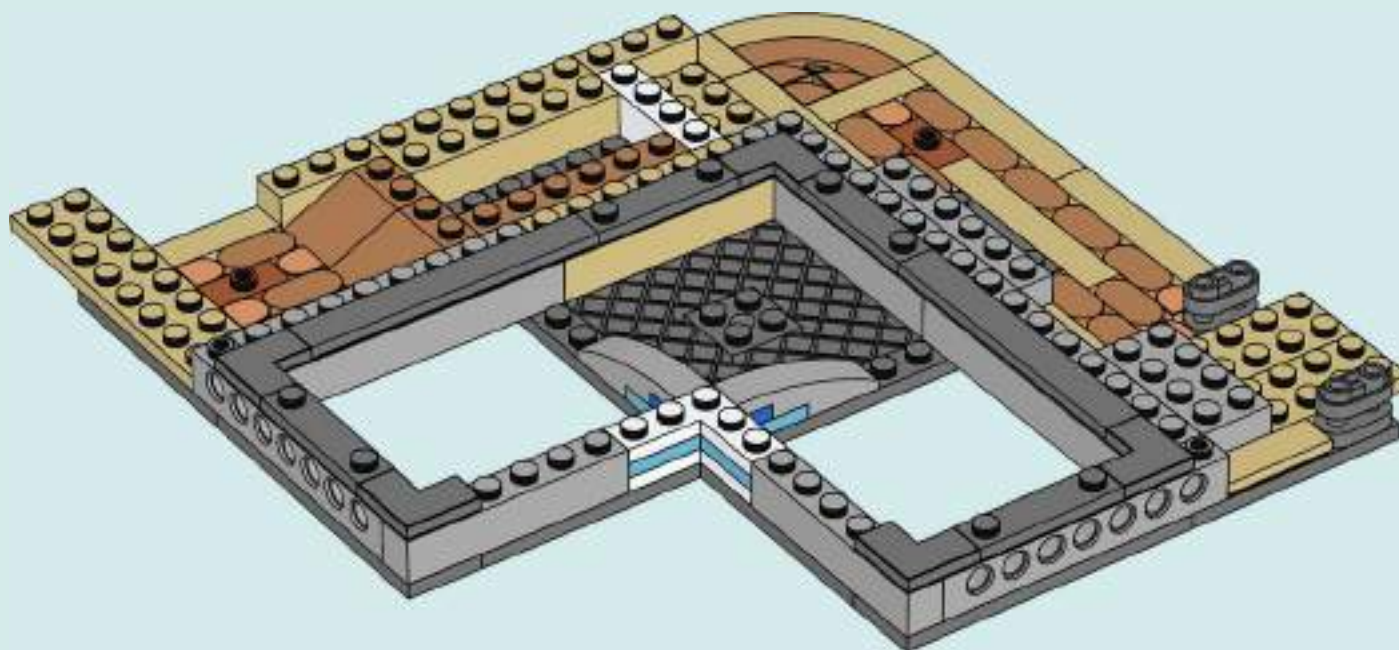



31

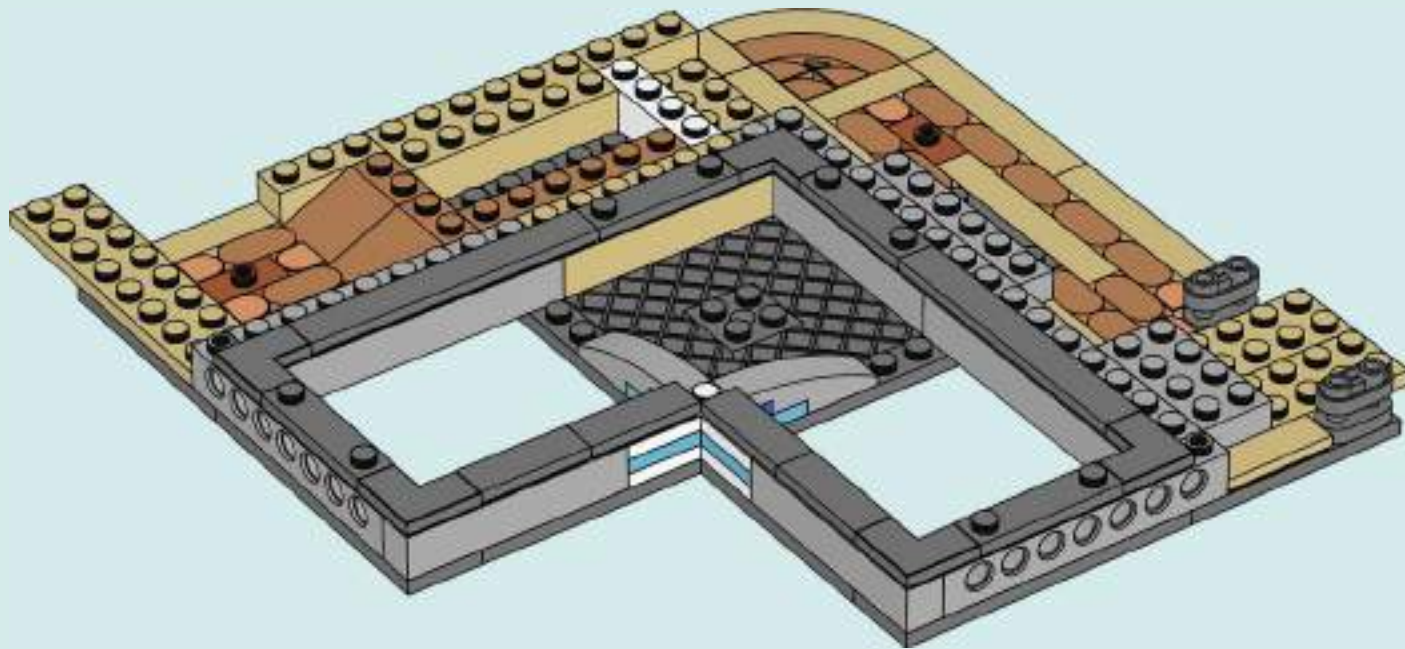



2x

32

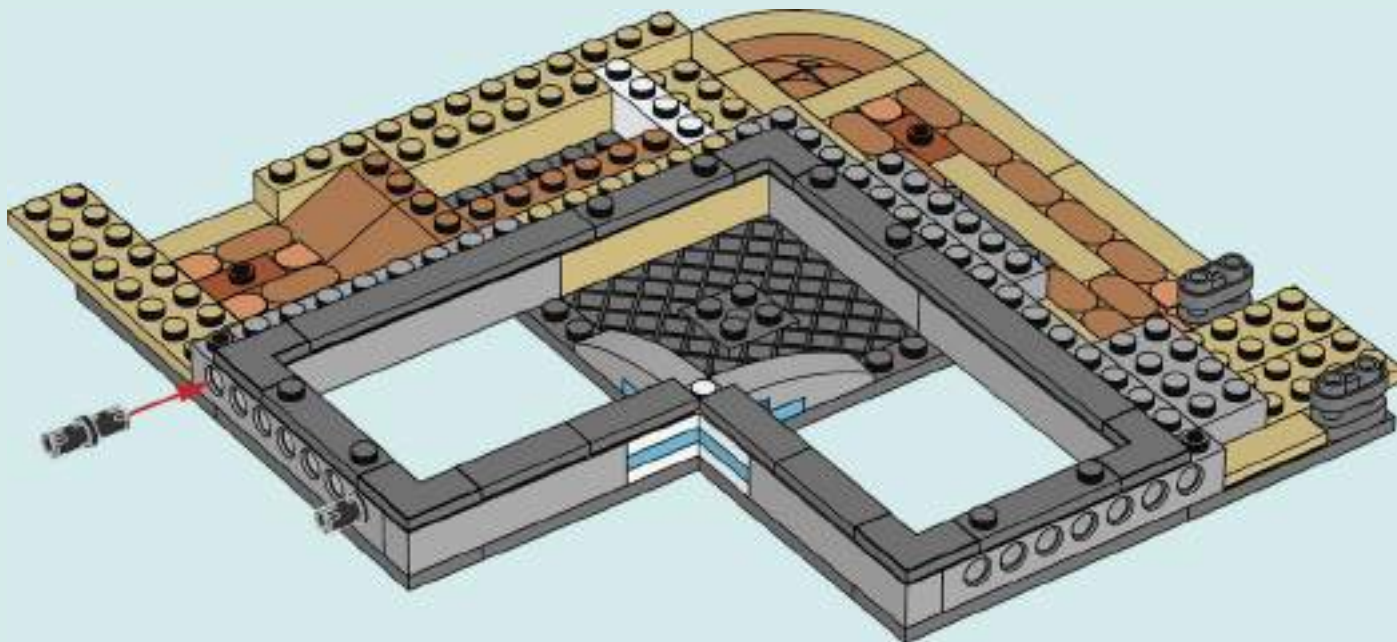





34

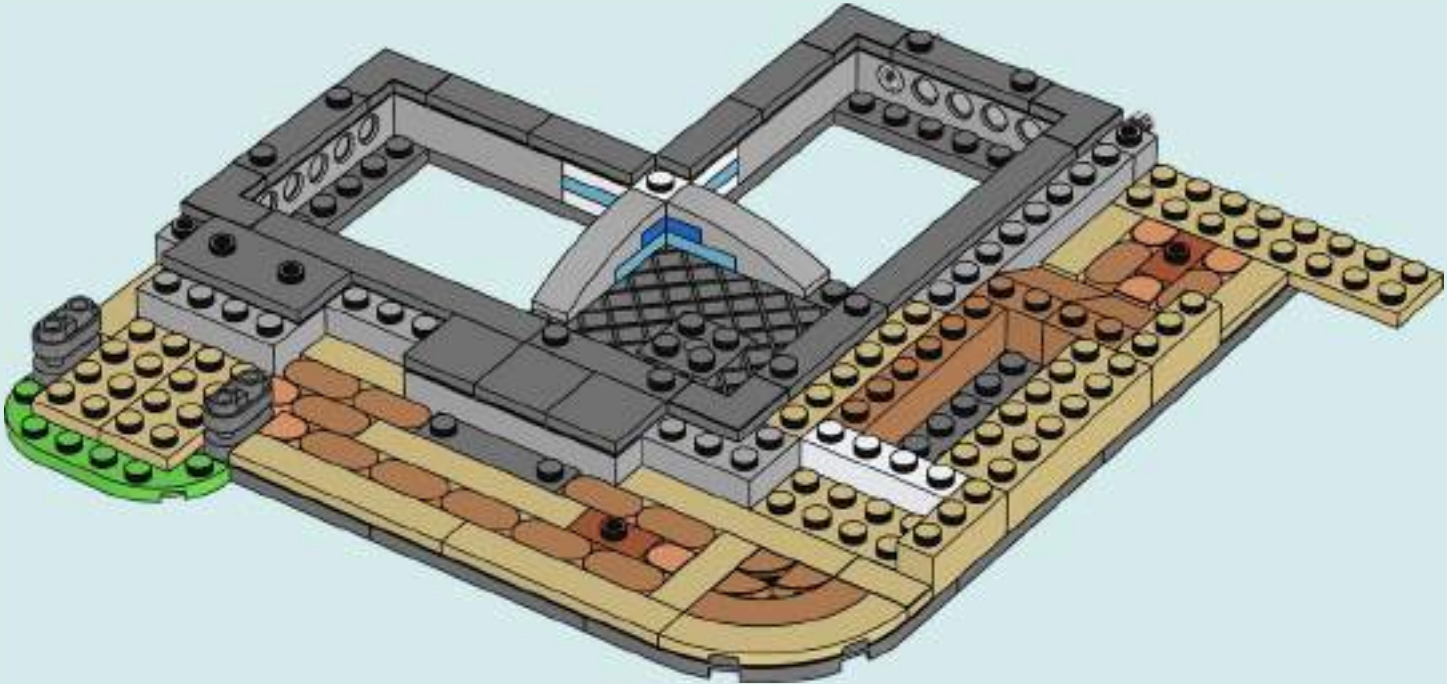



2x

35

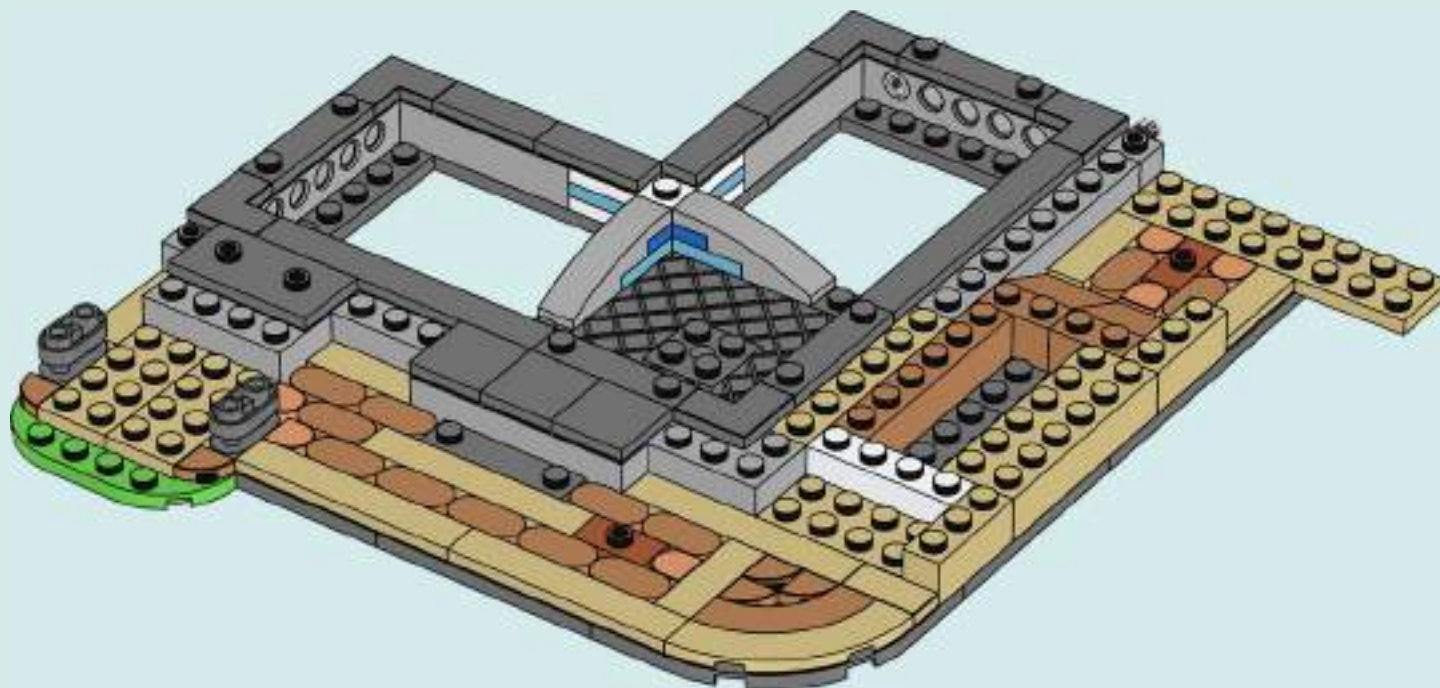



2x



1x

36

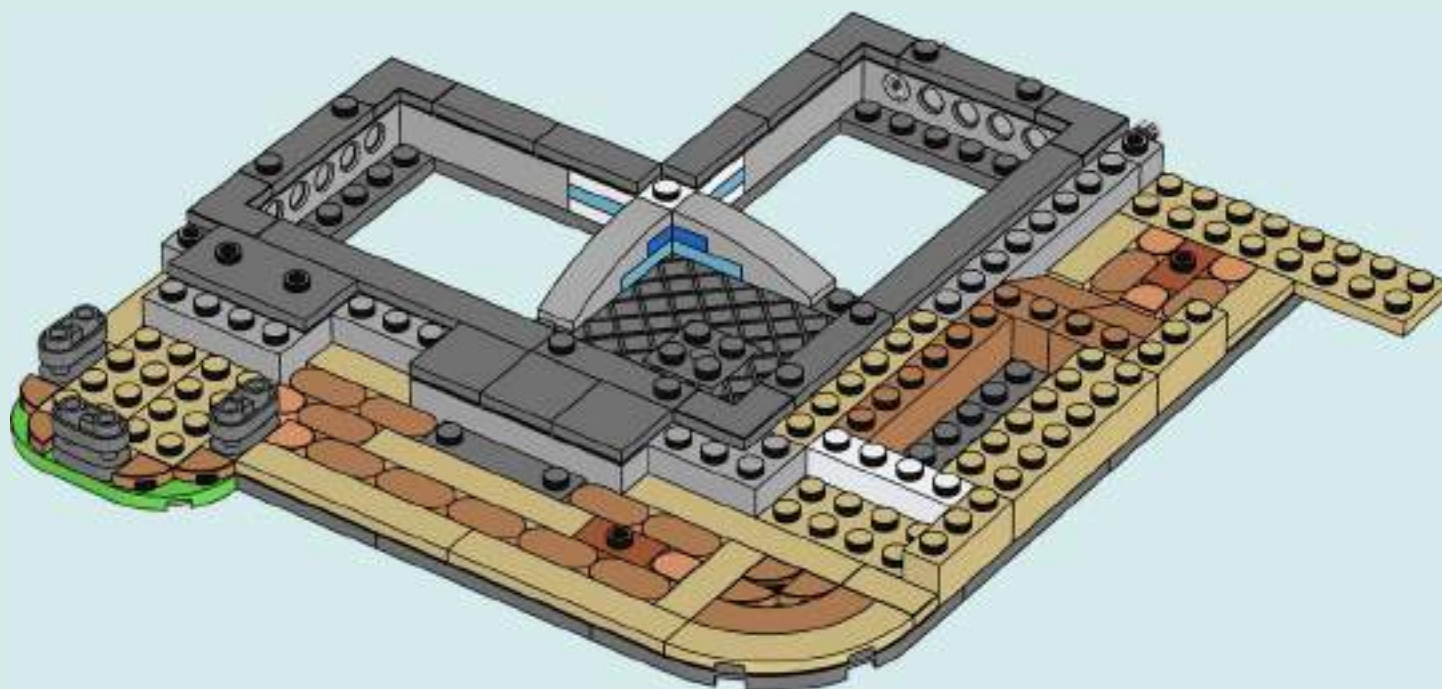





37

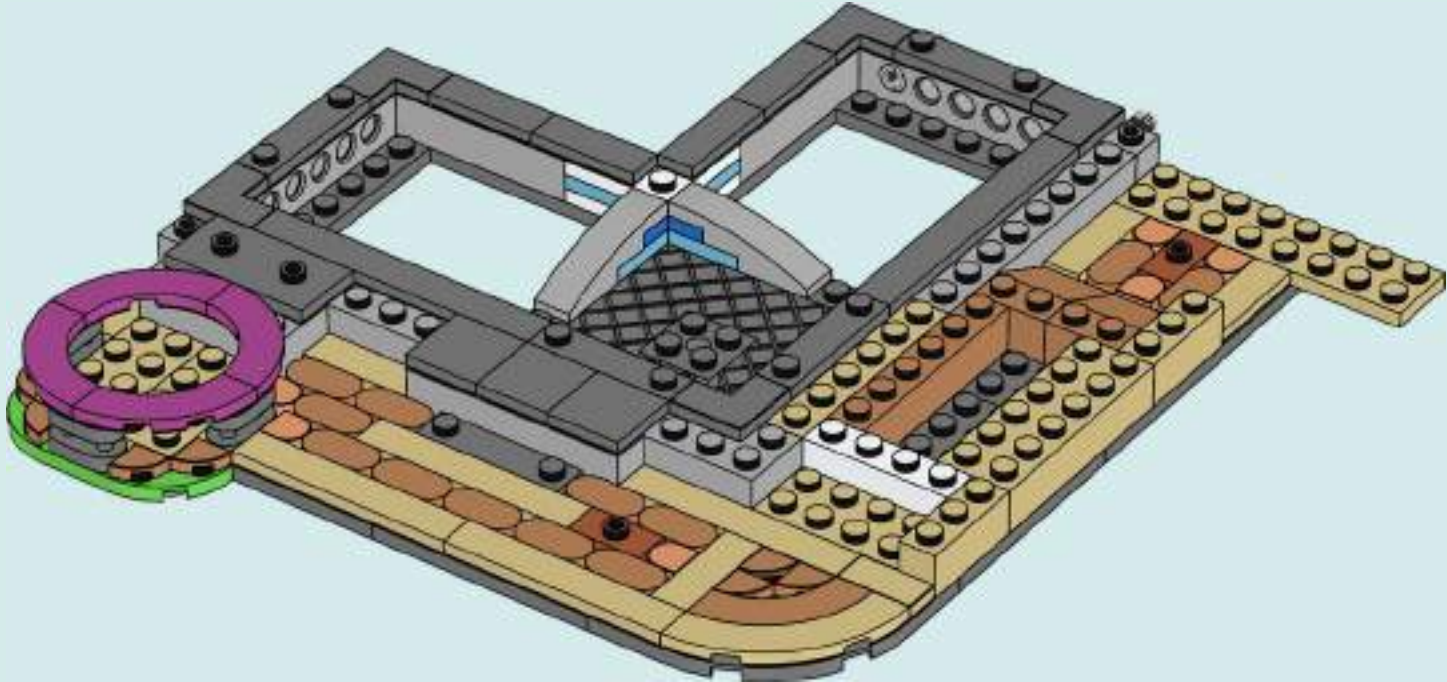



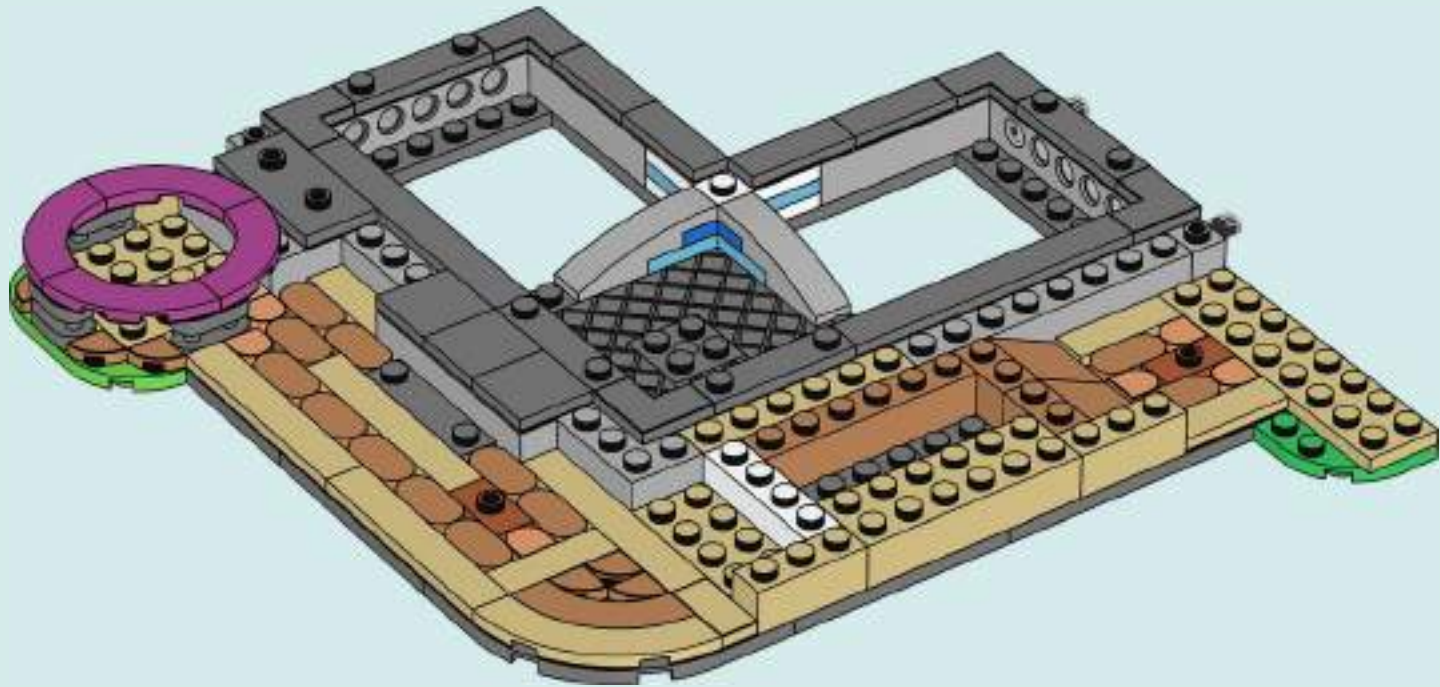

1x

38



1x  1x 

39

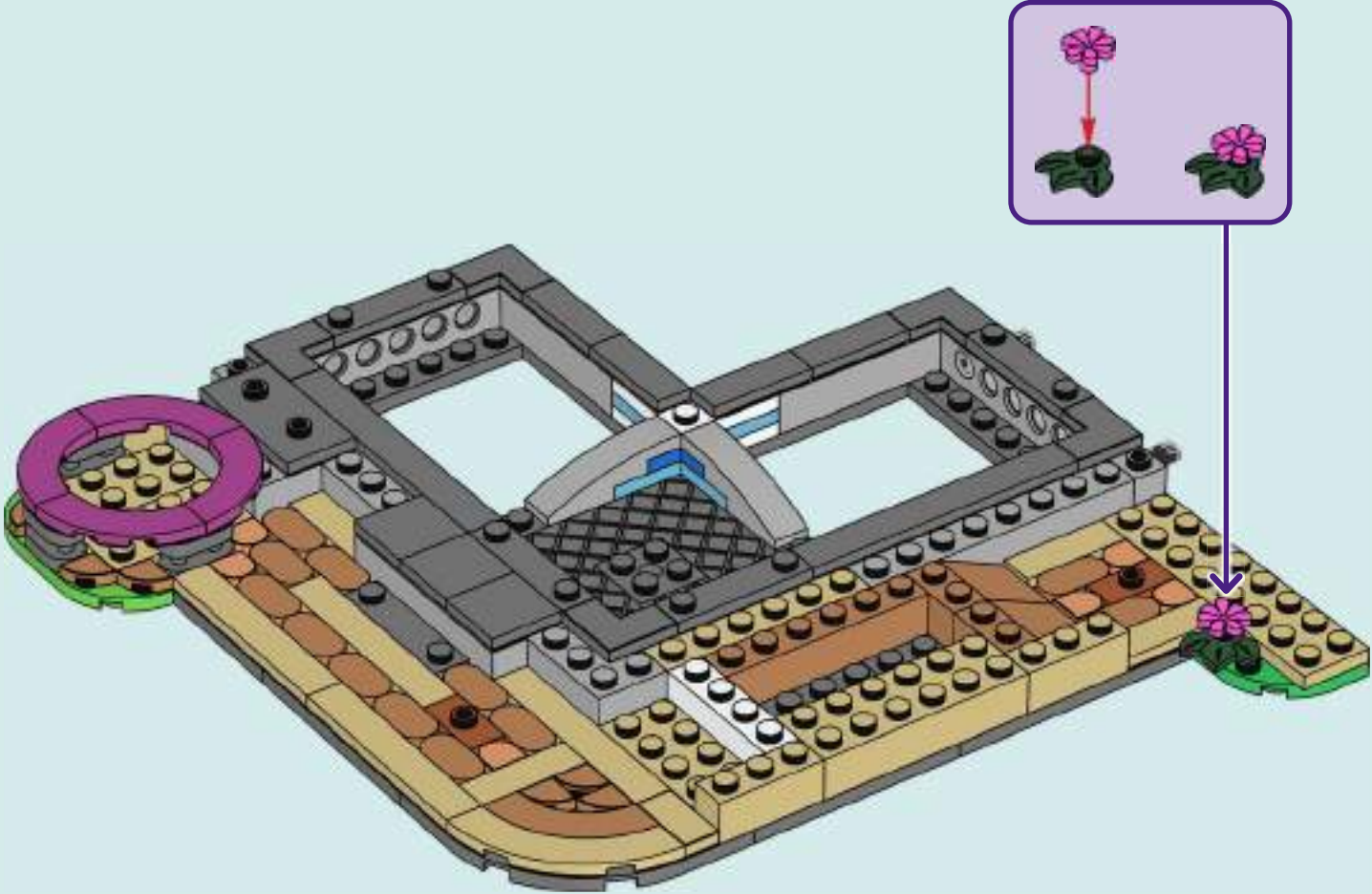



2x

40

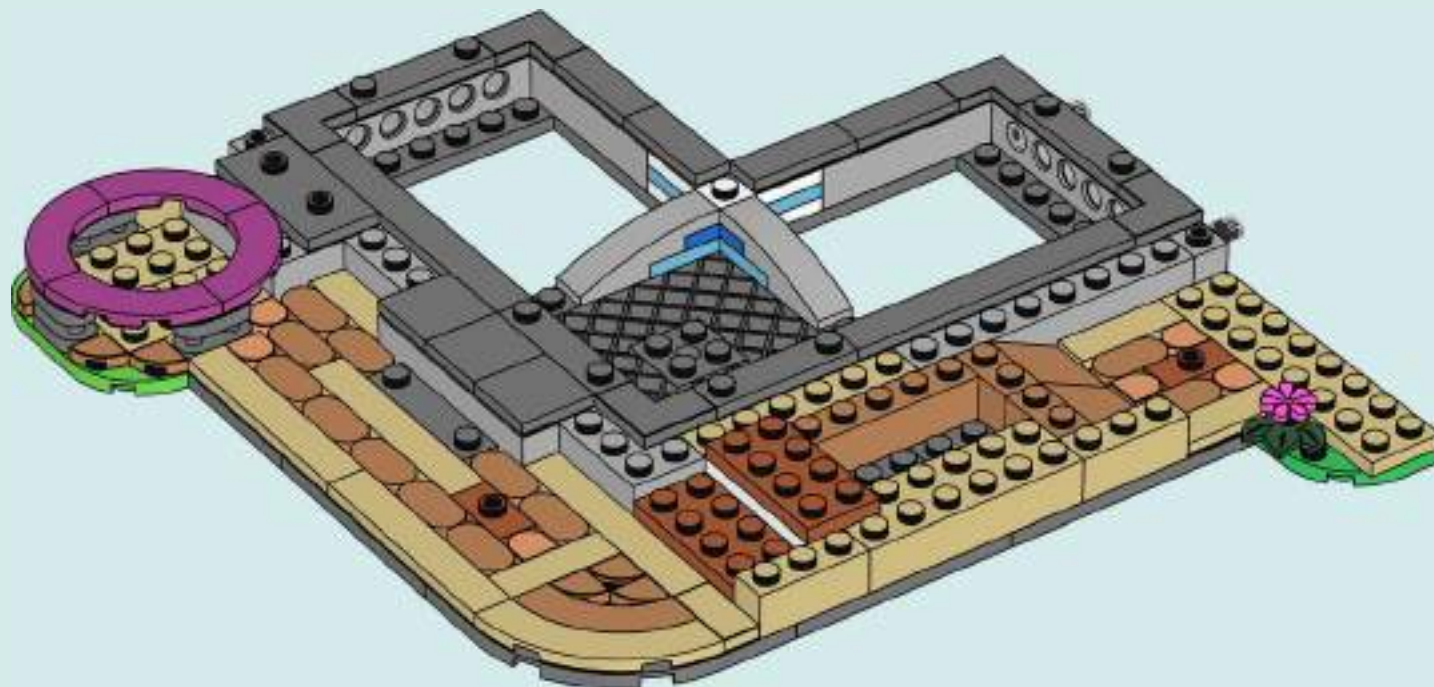

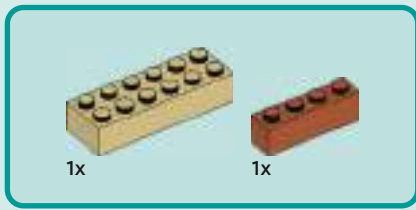

41

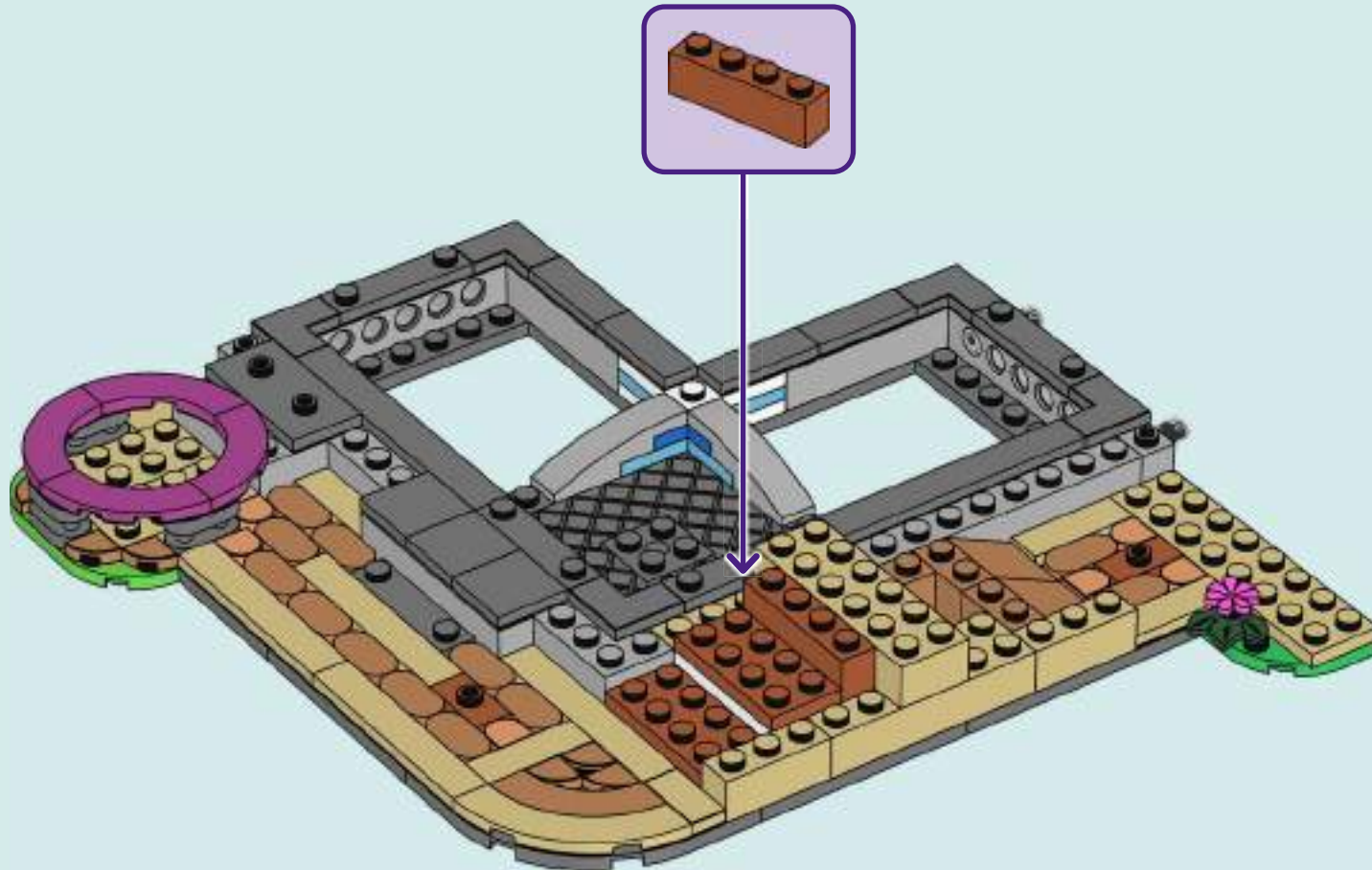



4x



2x

42

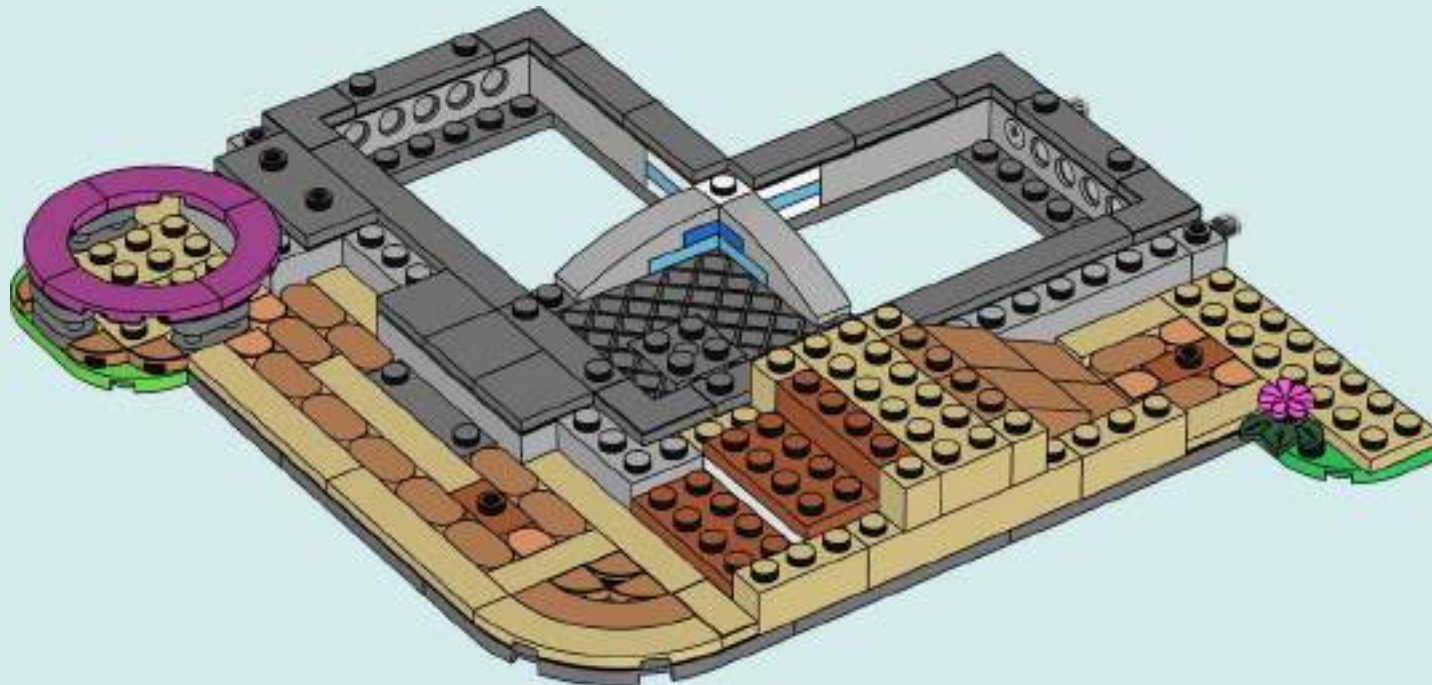

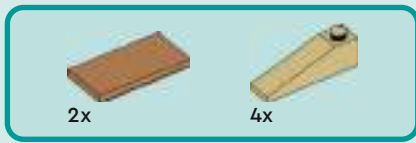

43

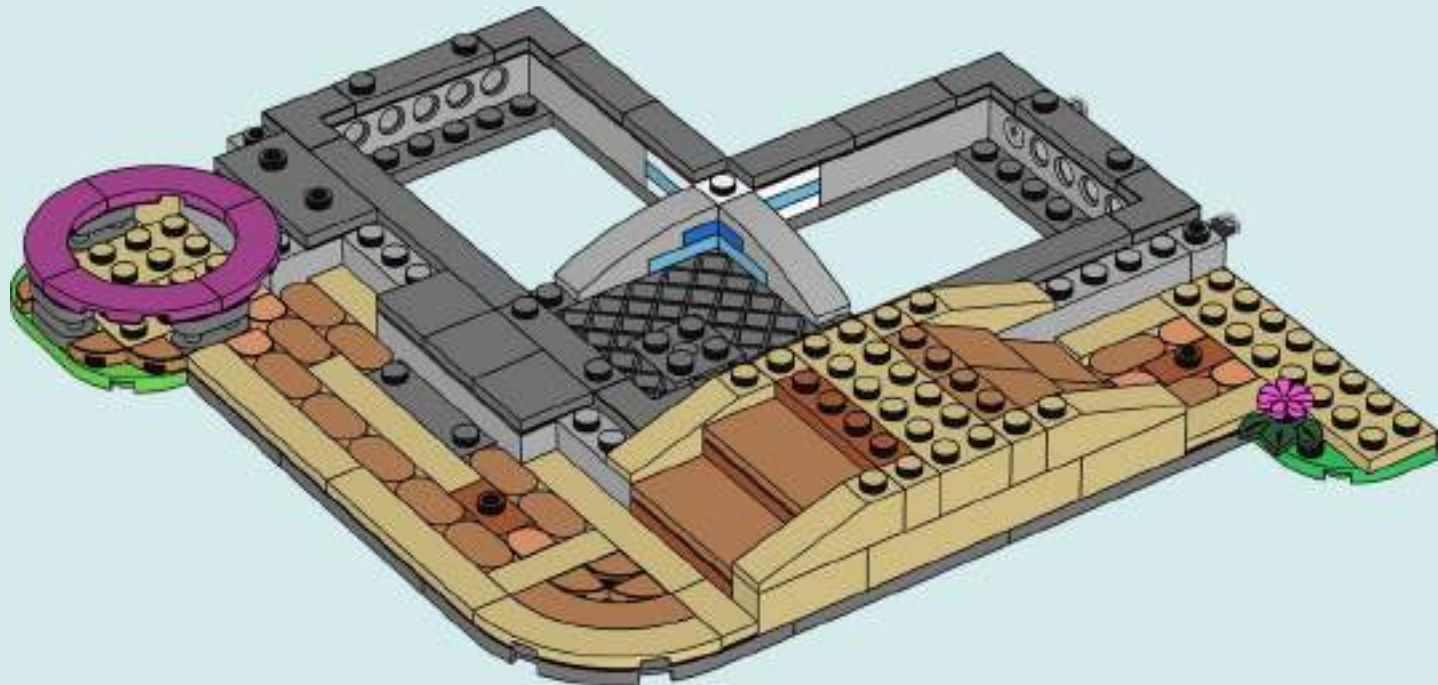



44

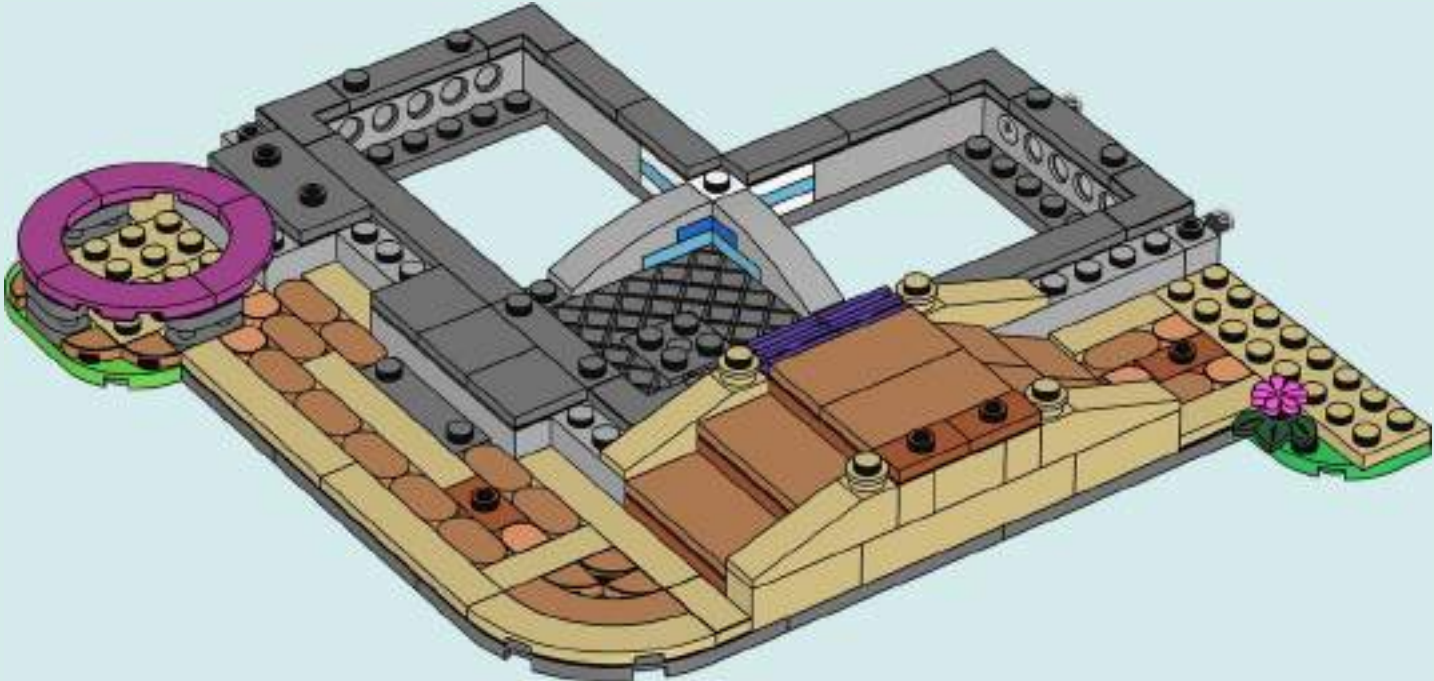





2x

45

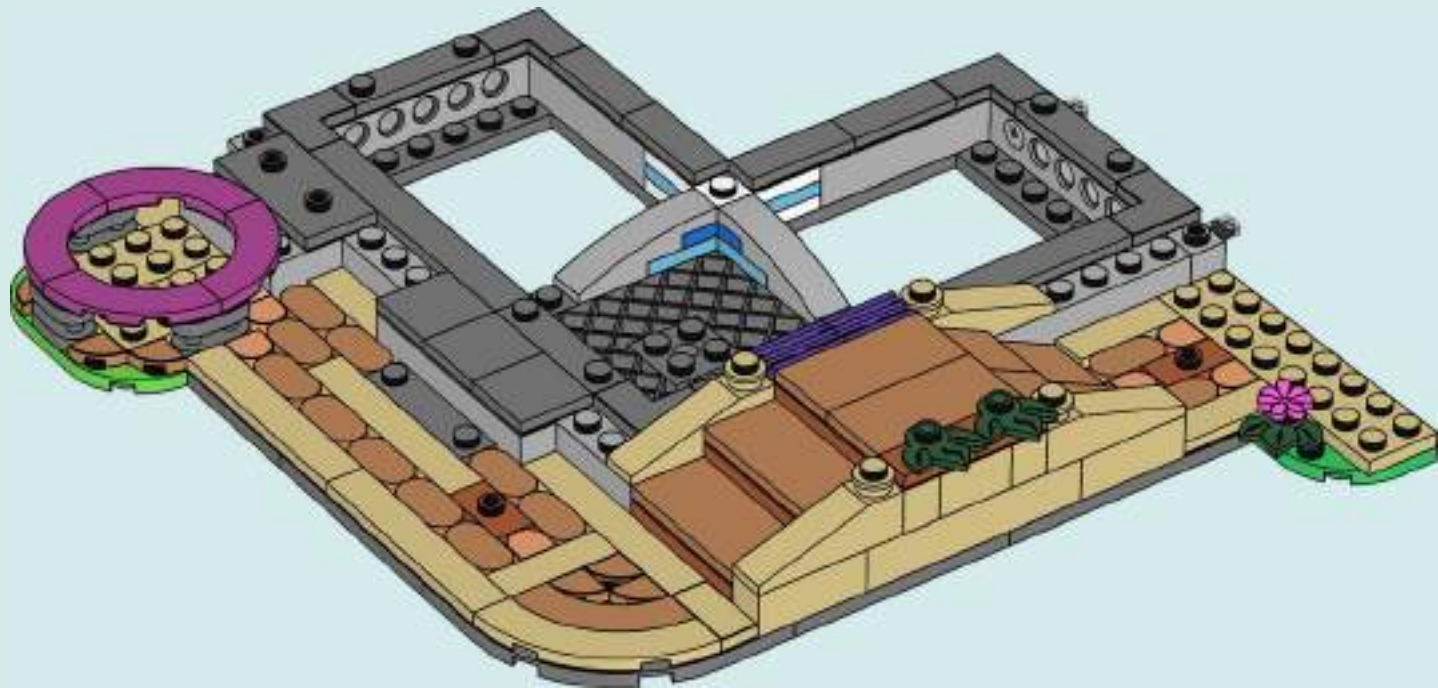



2x



2x

46

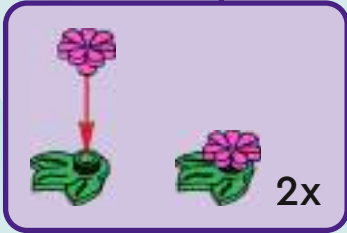

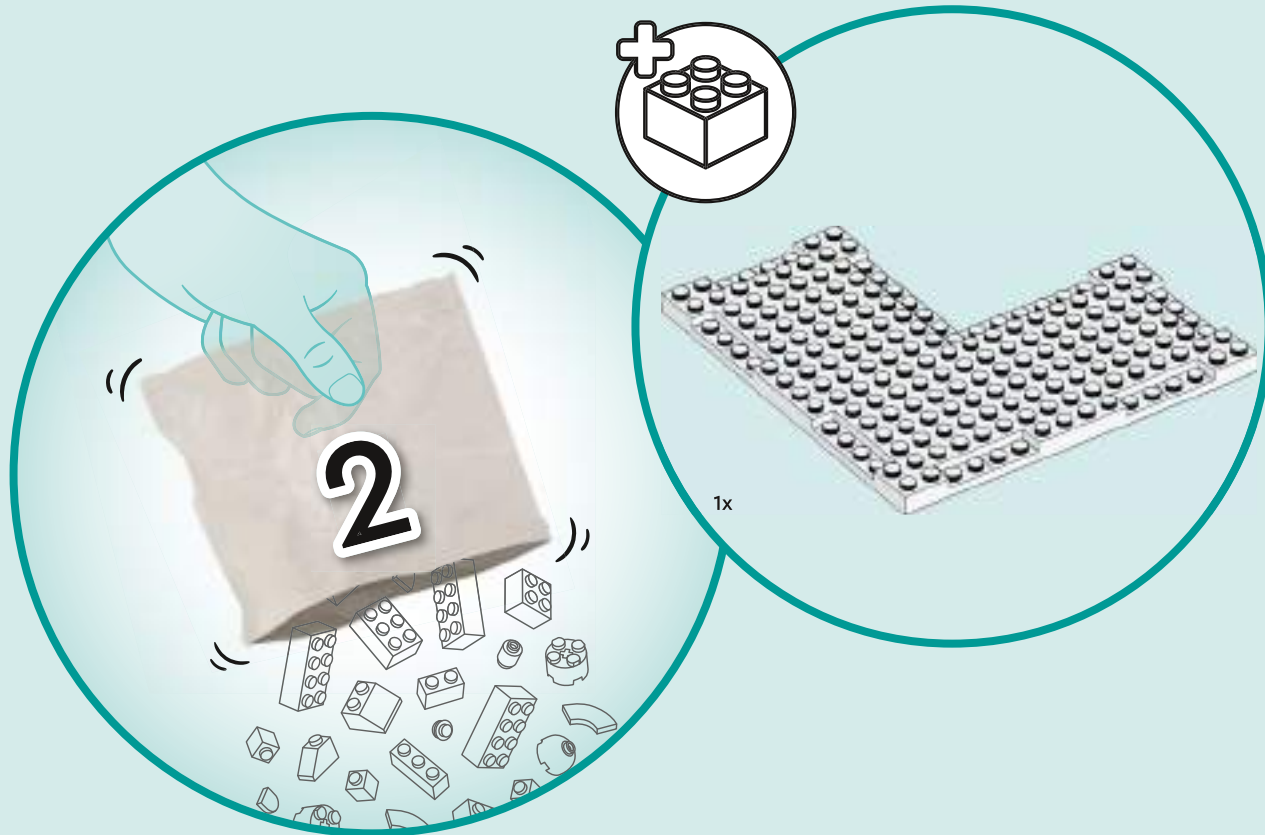



1

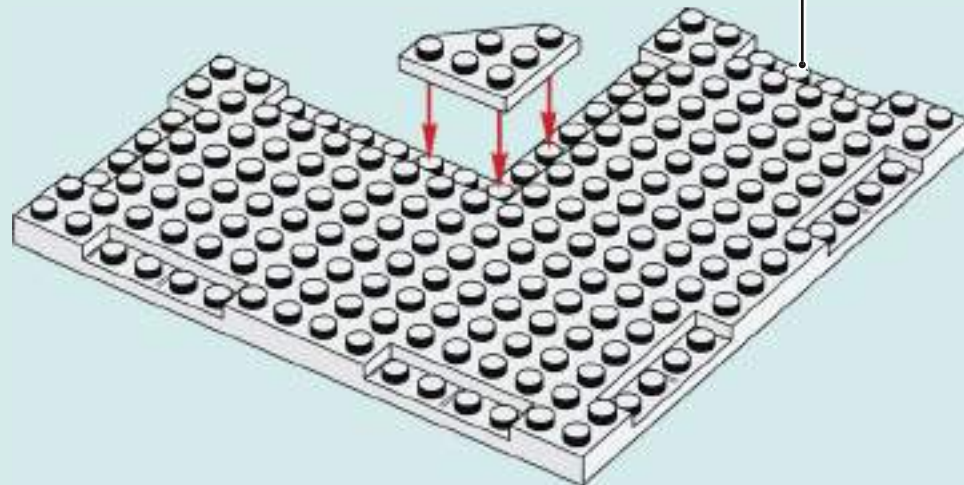
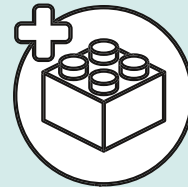



2

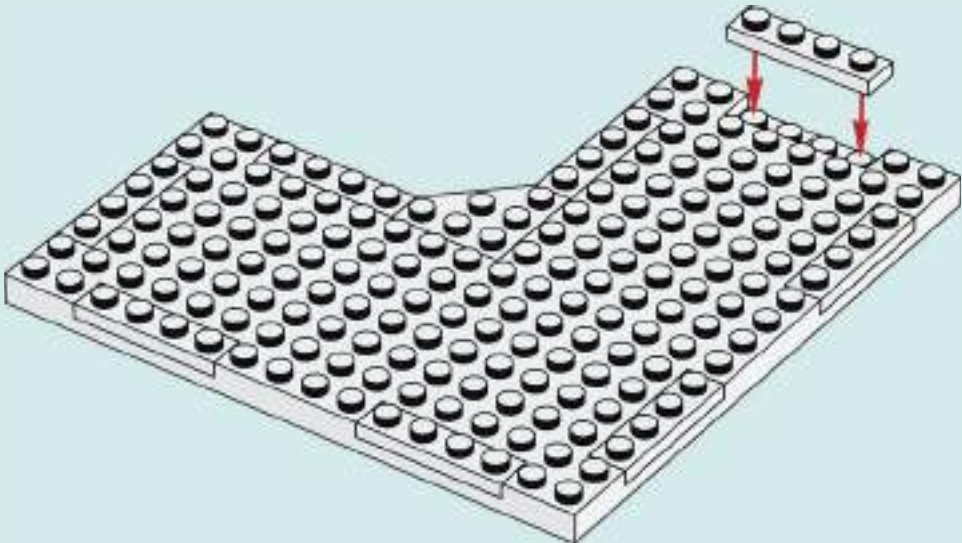

3

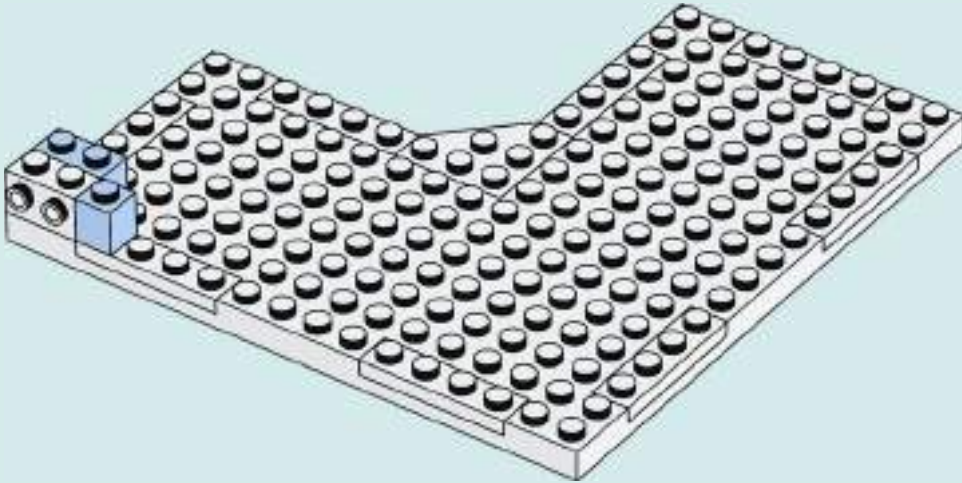



1x



1x

4

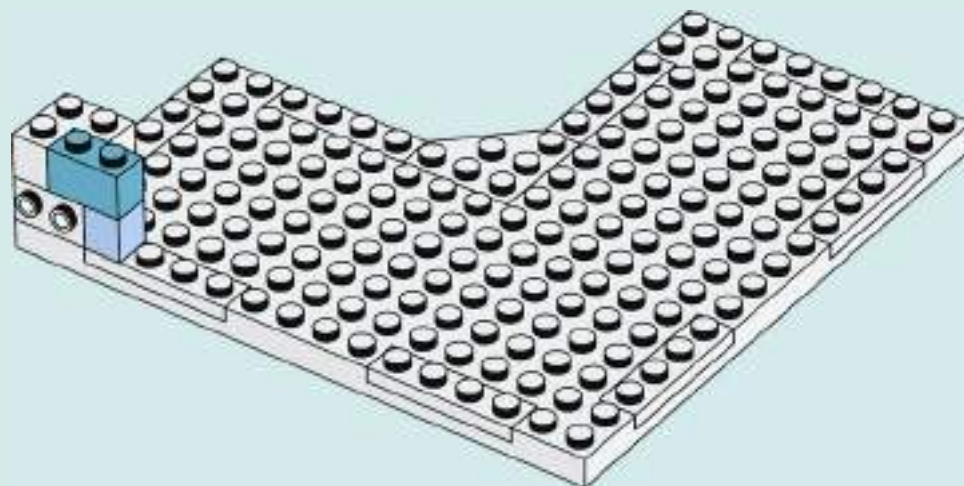

1x



1x



1x

5

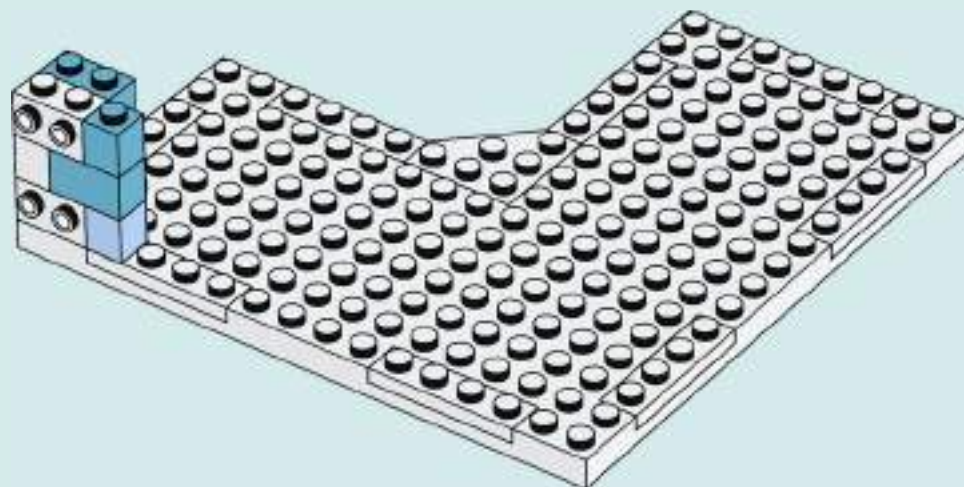



6

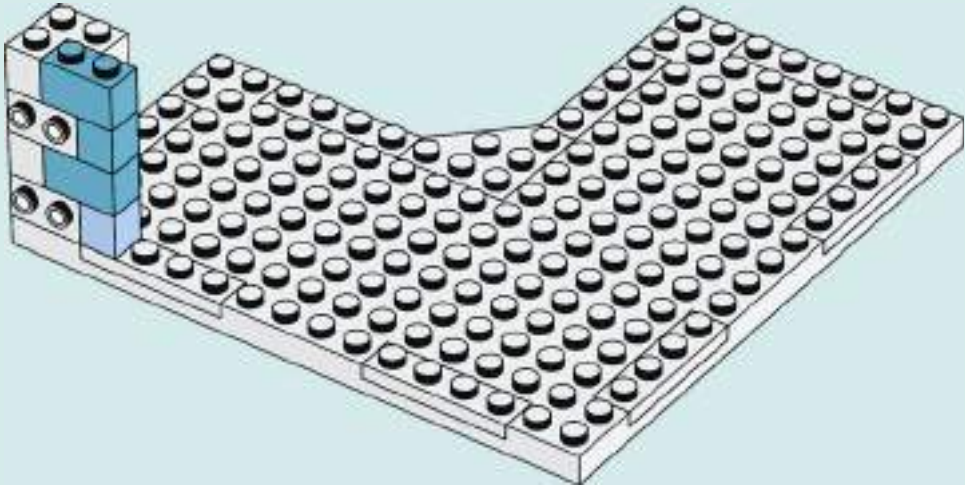

7

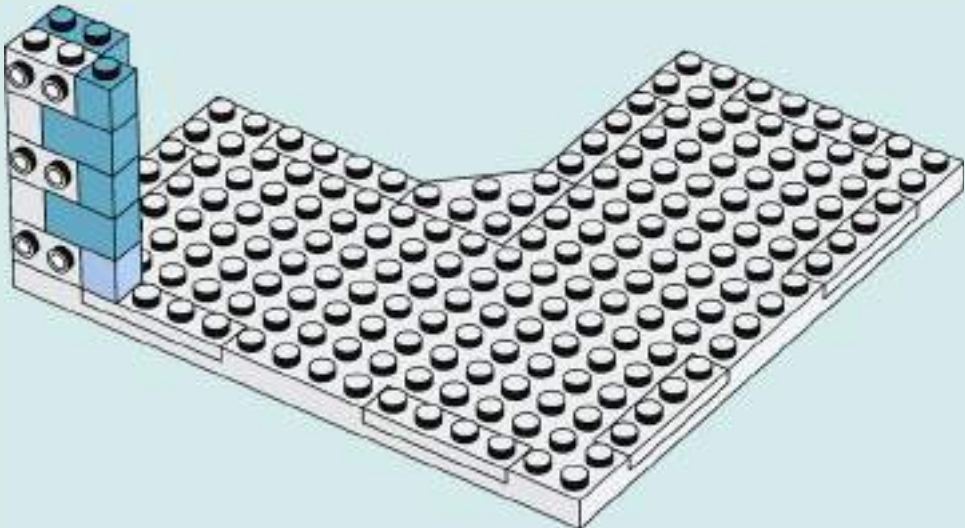



8

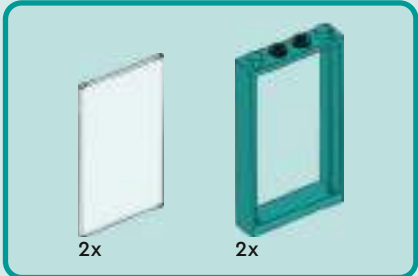
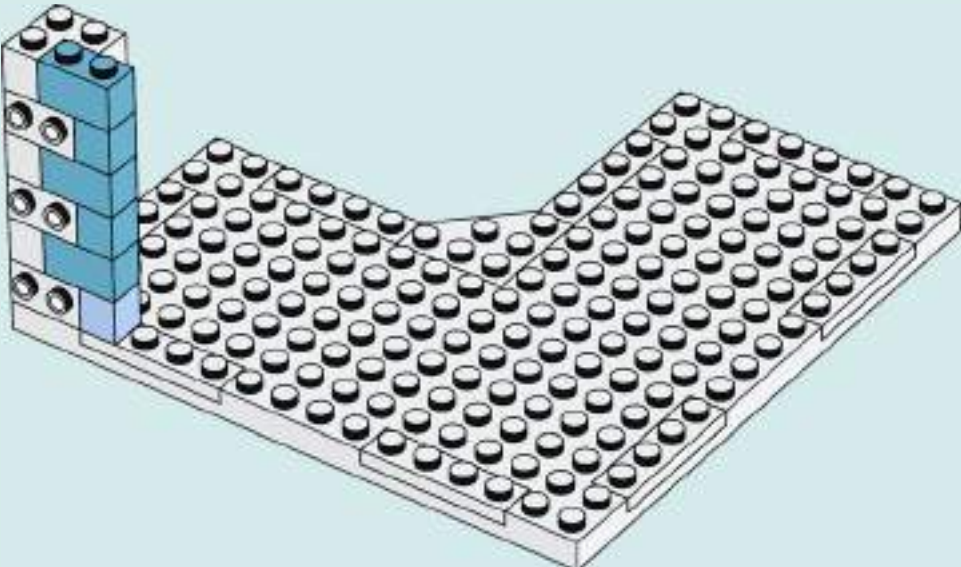

9

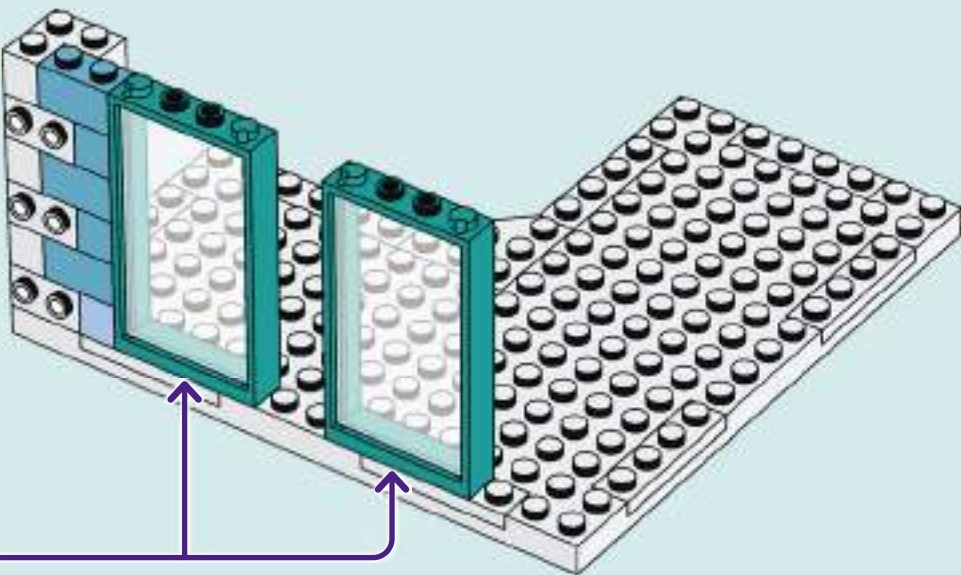
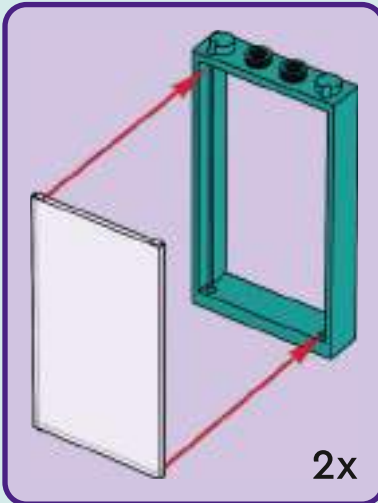



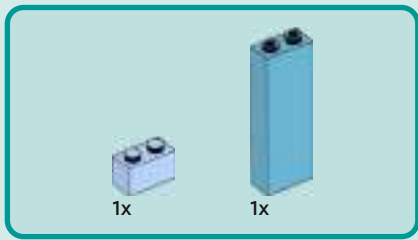

10

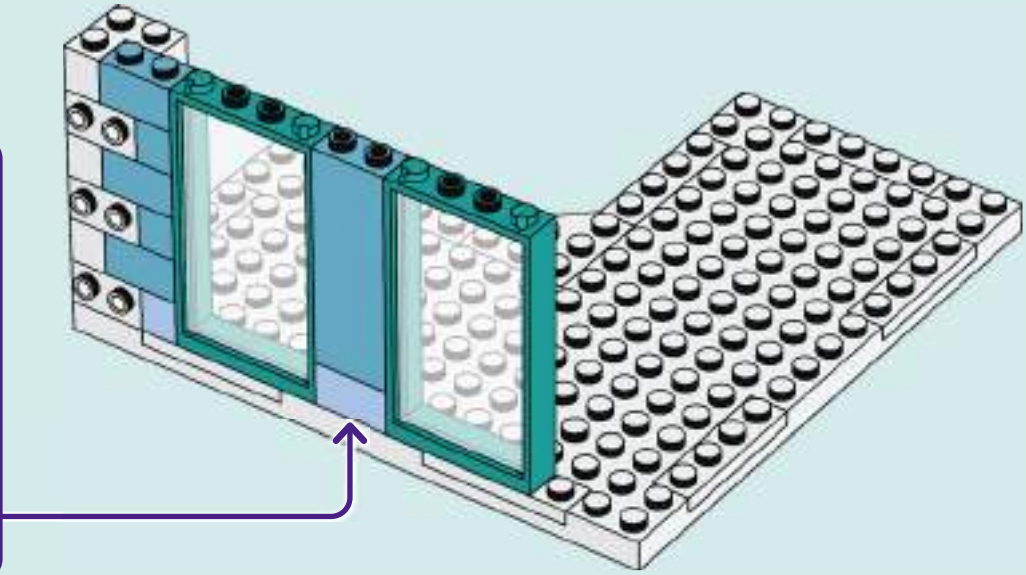
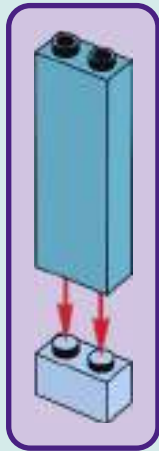

11

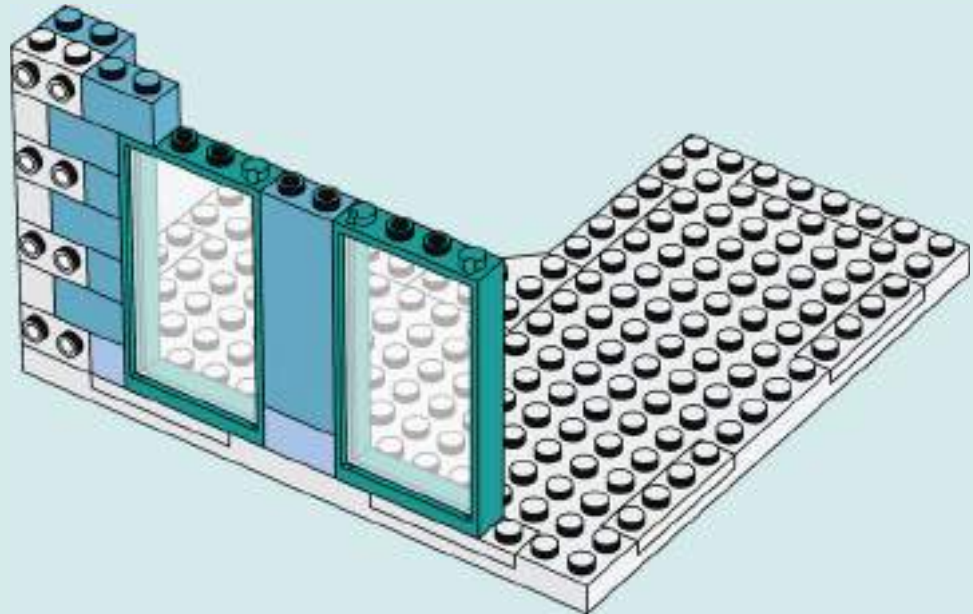

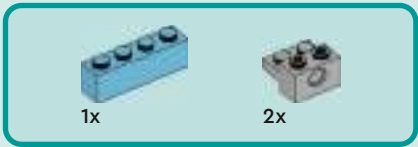

12

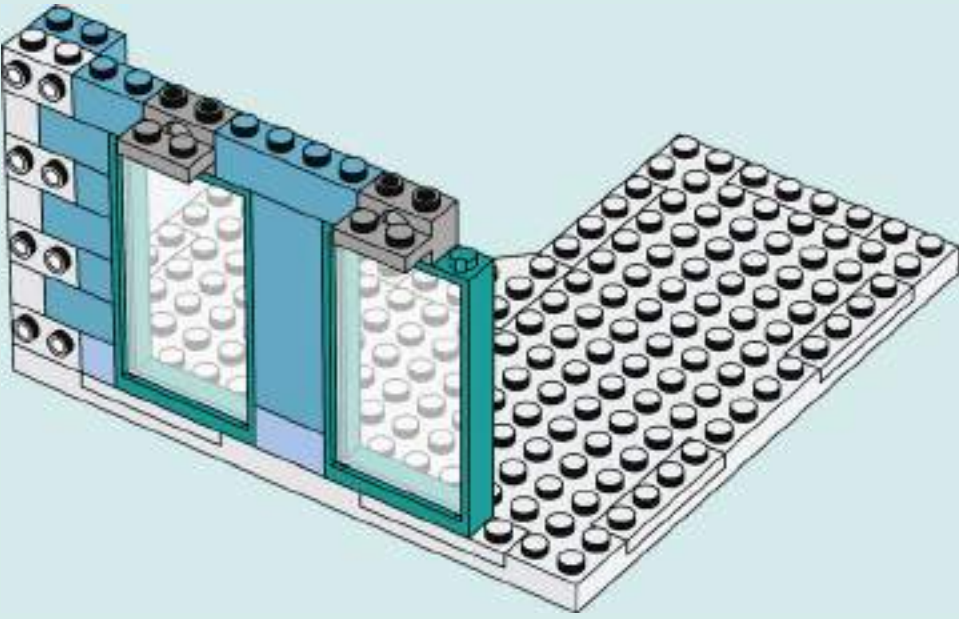

13

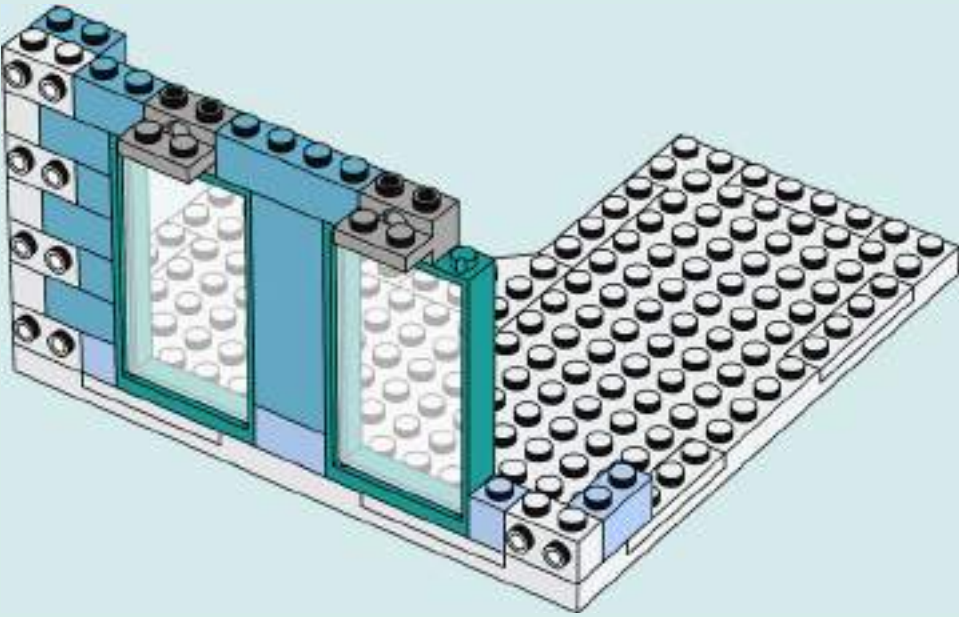



14

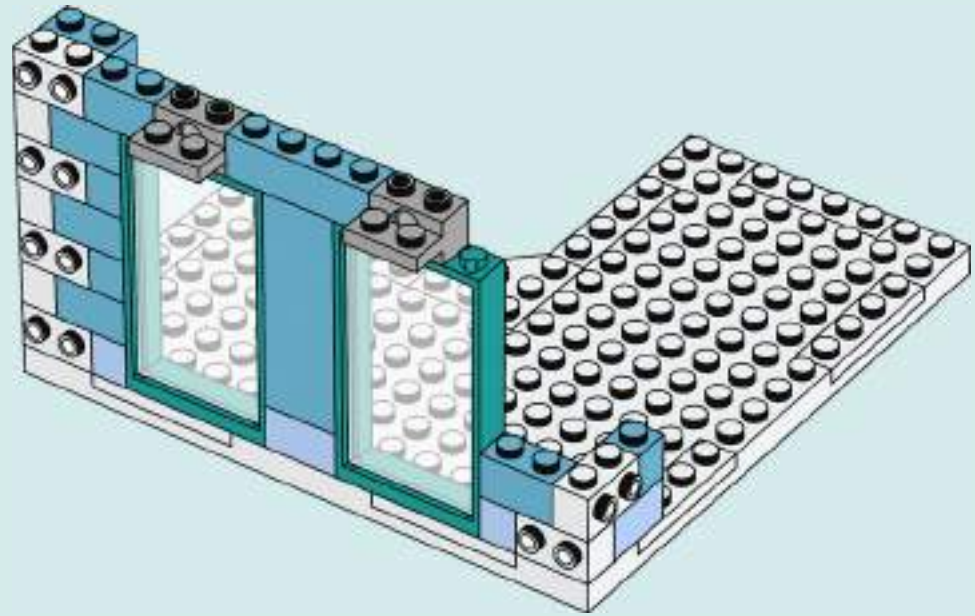

15

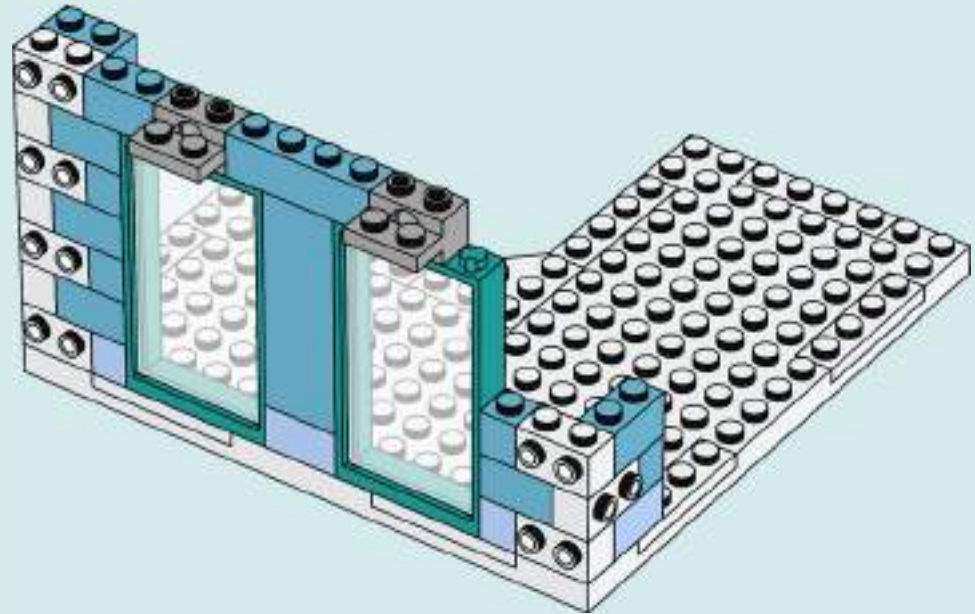



16

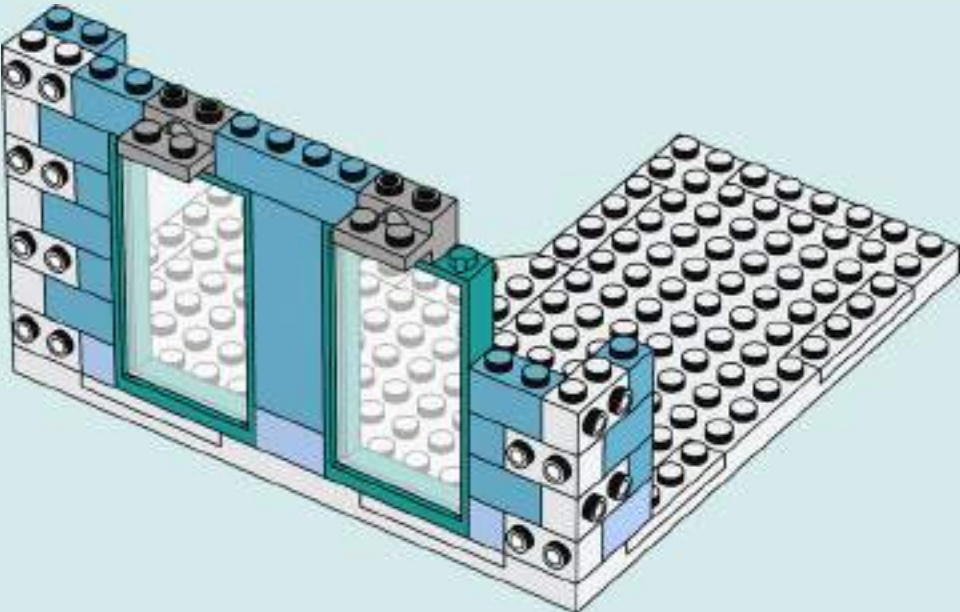

17

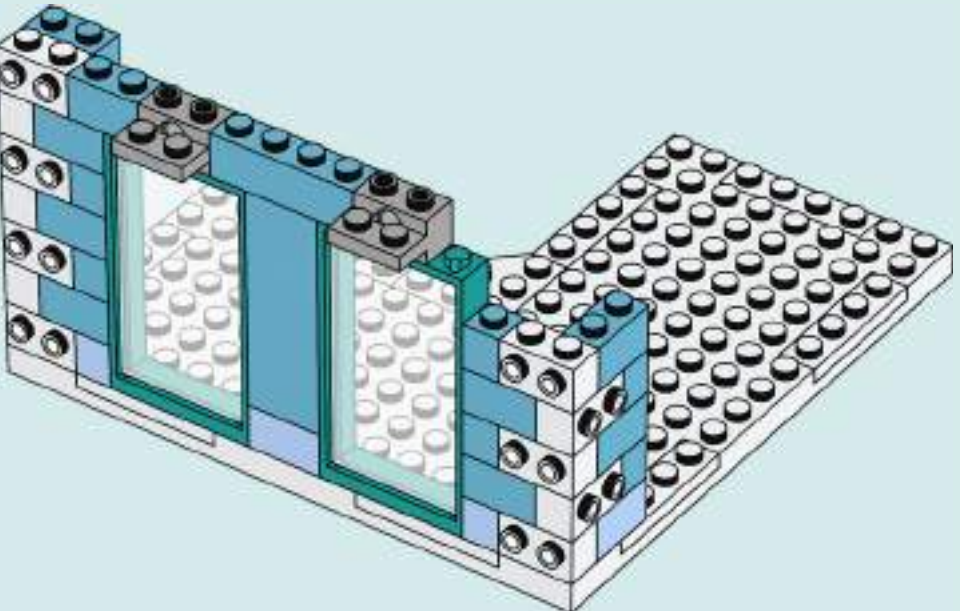



18

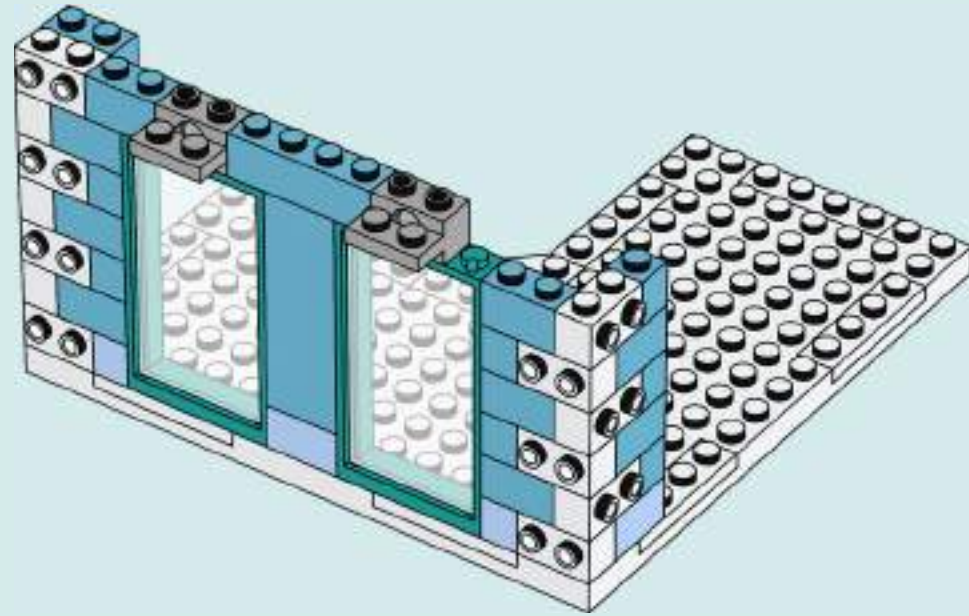

19

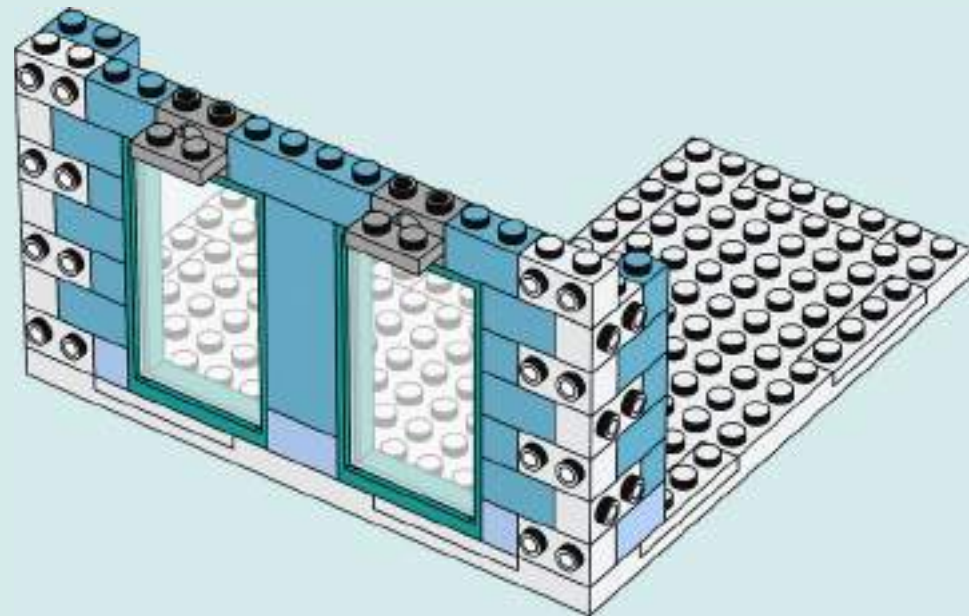



2x

20

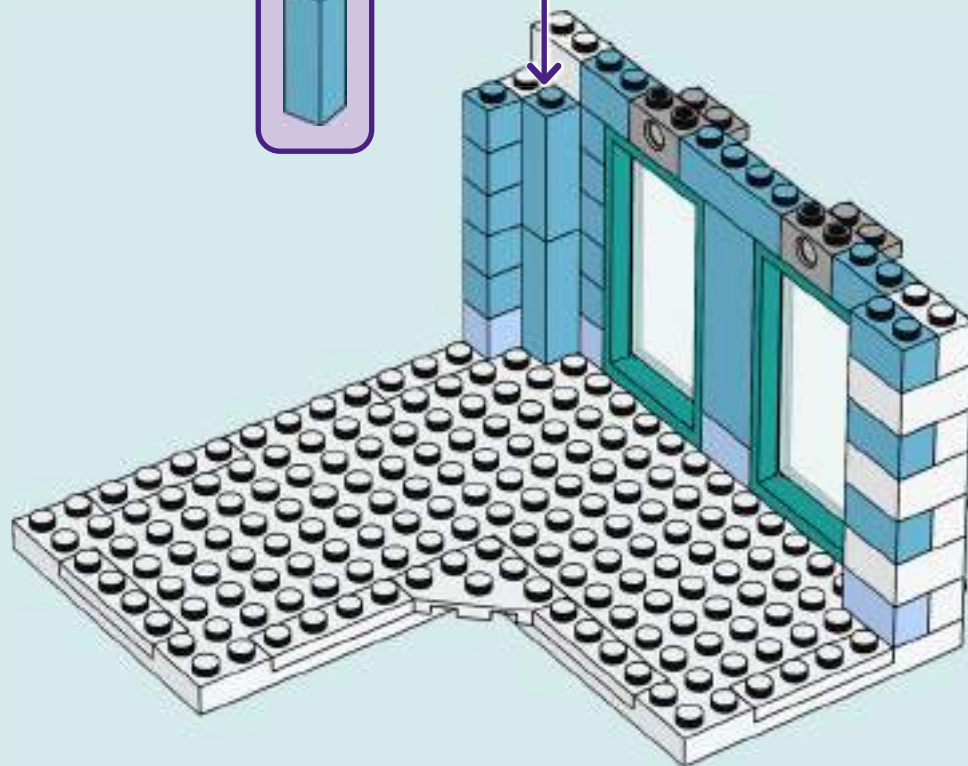
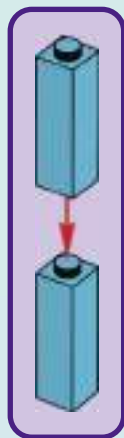

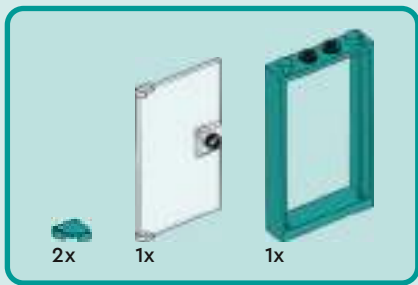

21

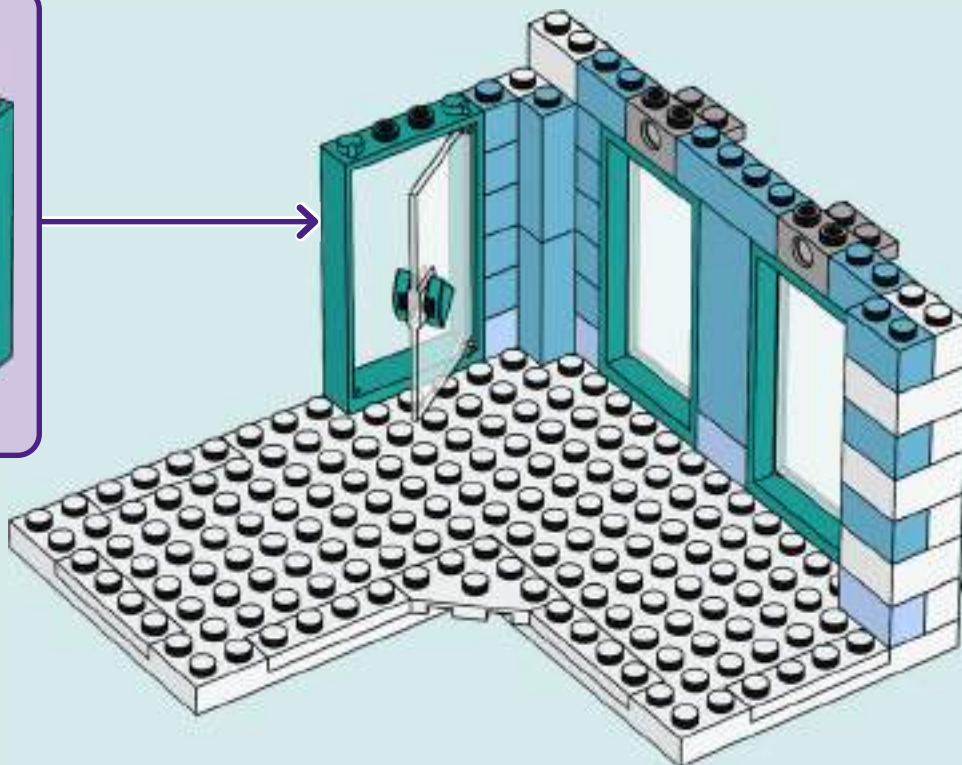
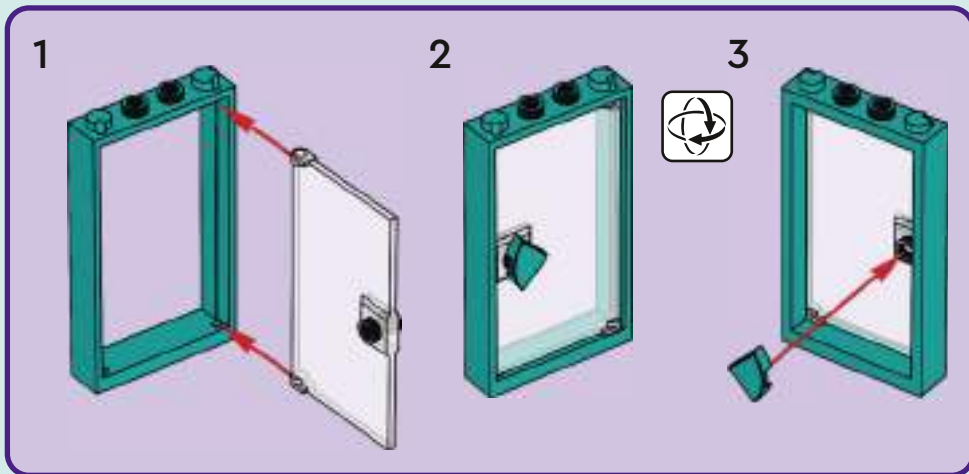

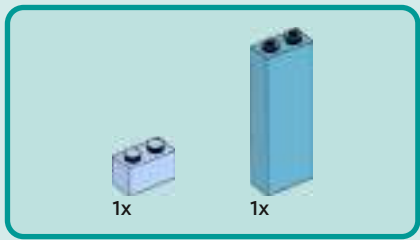

22

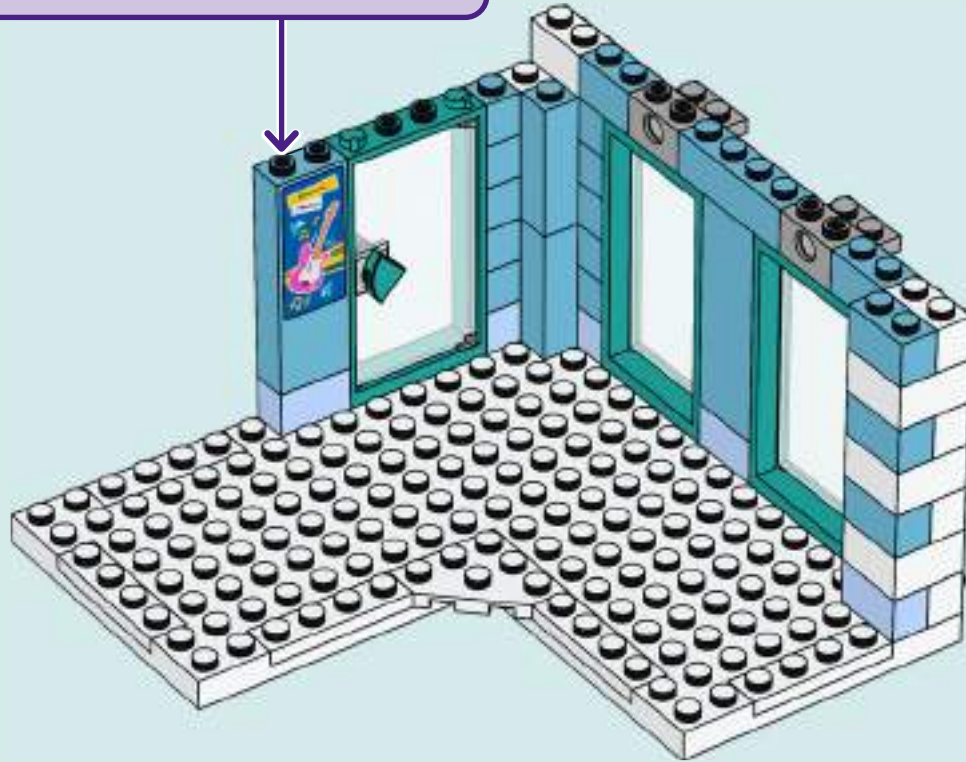
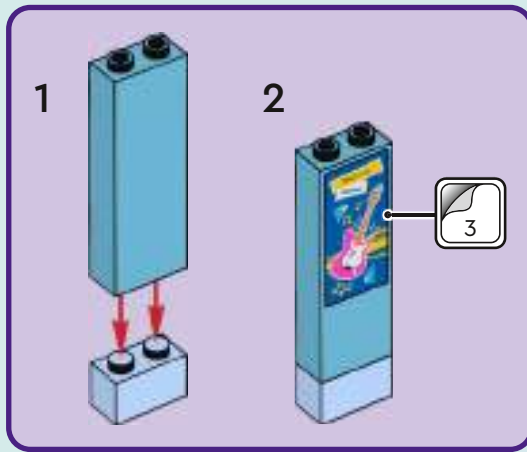



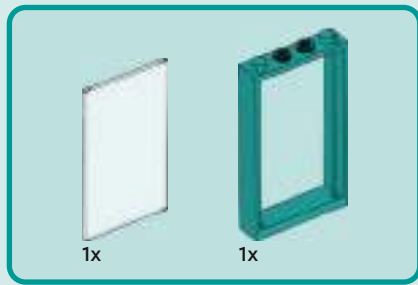

23

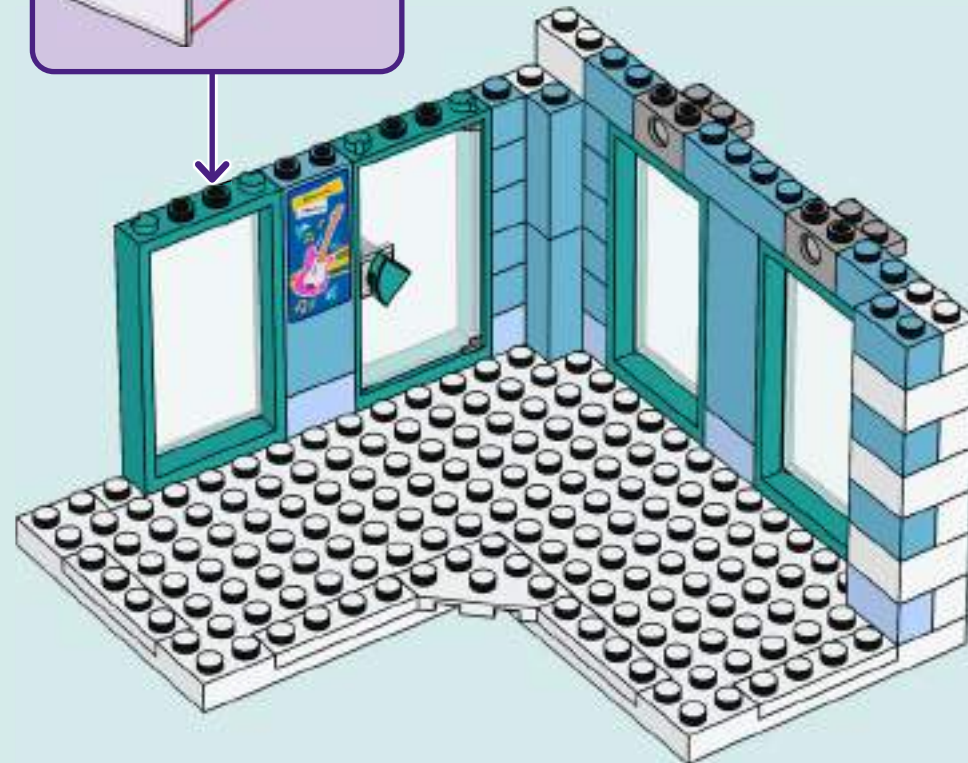
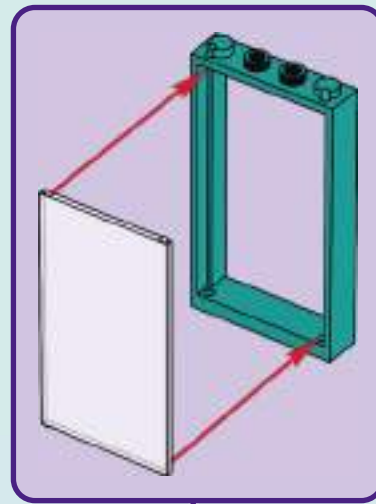



1x



2x



2x

# 24

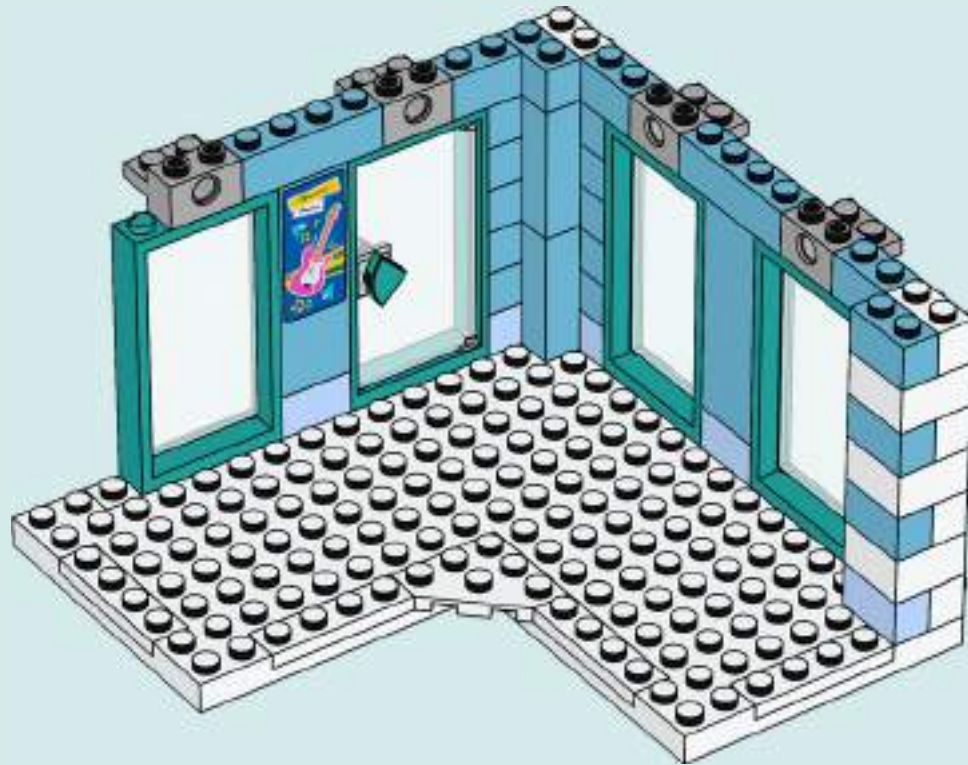



1x



1x

25

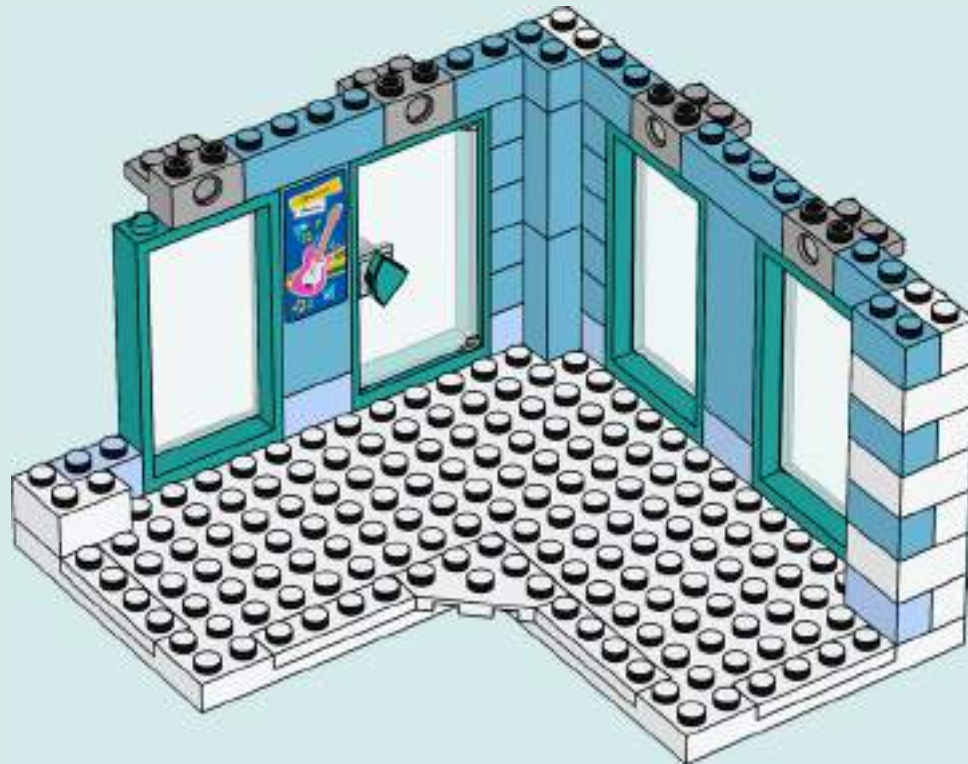



26

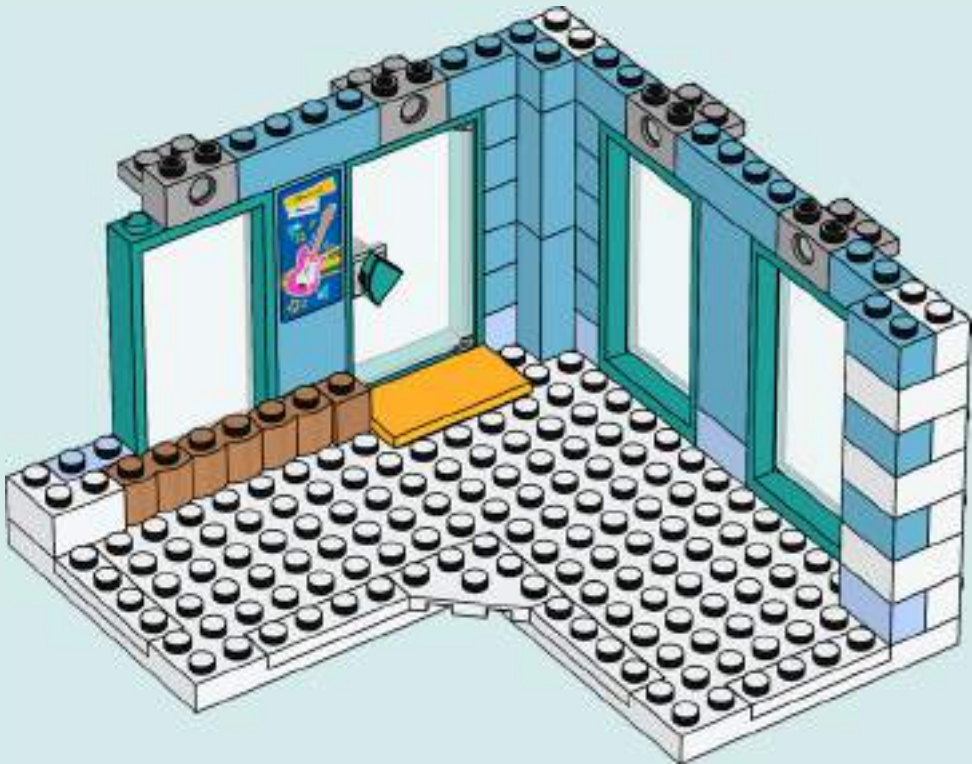



27



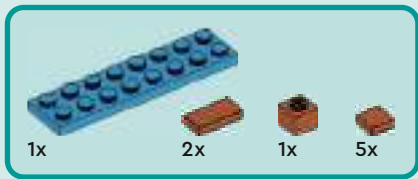

28

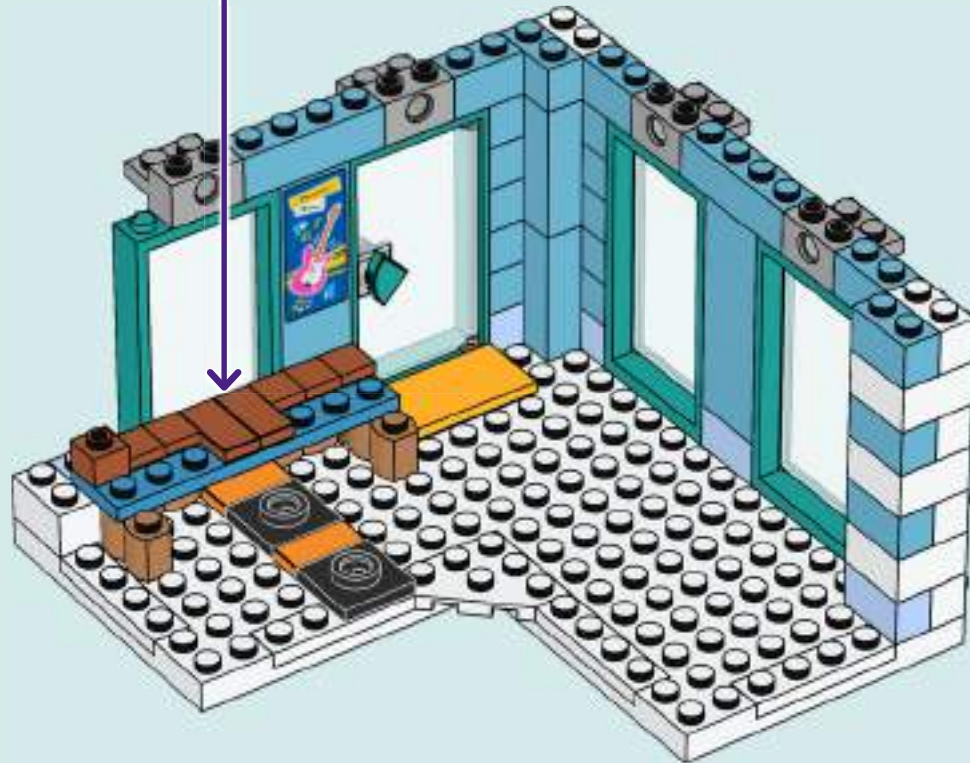
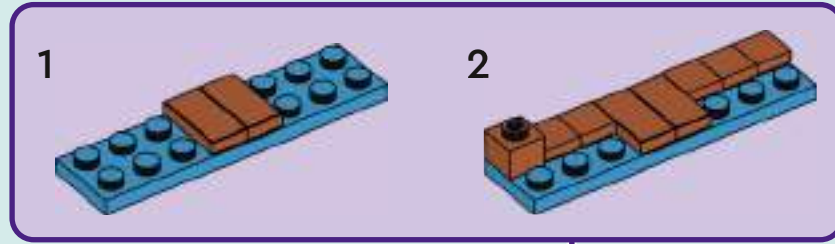



29

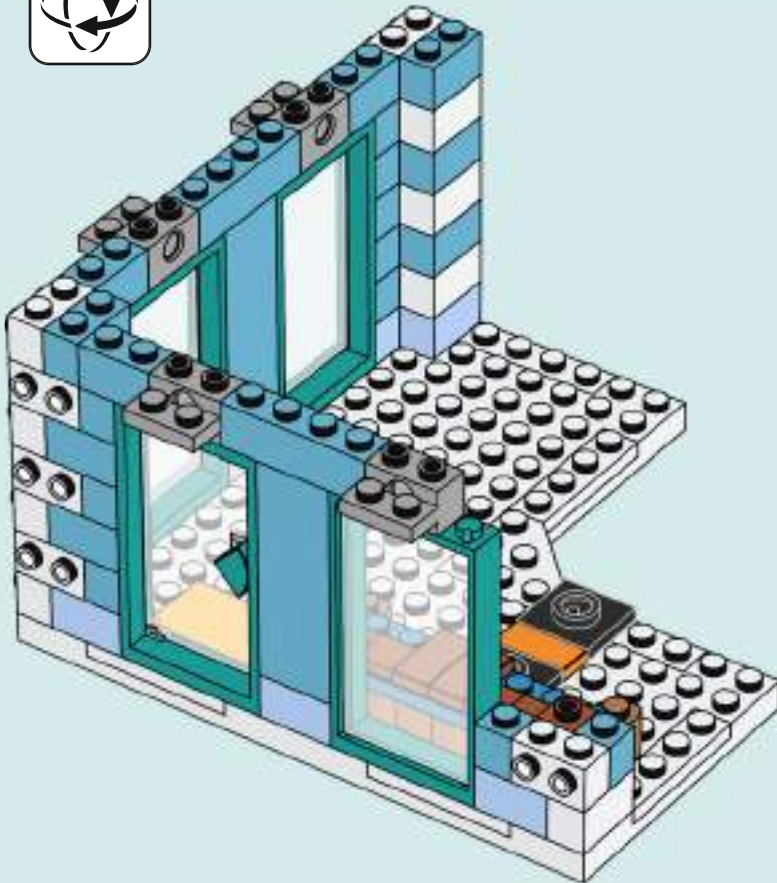

30

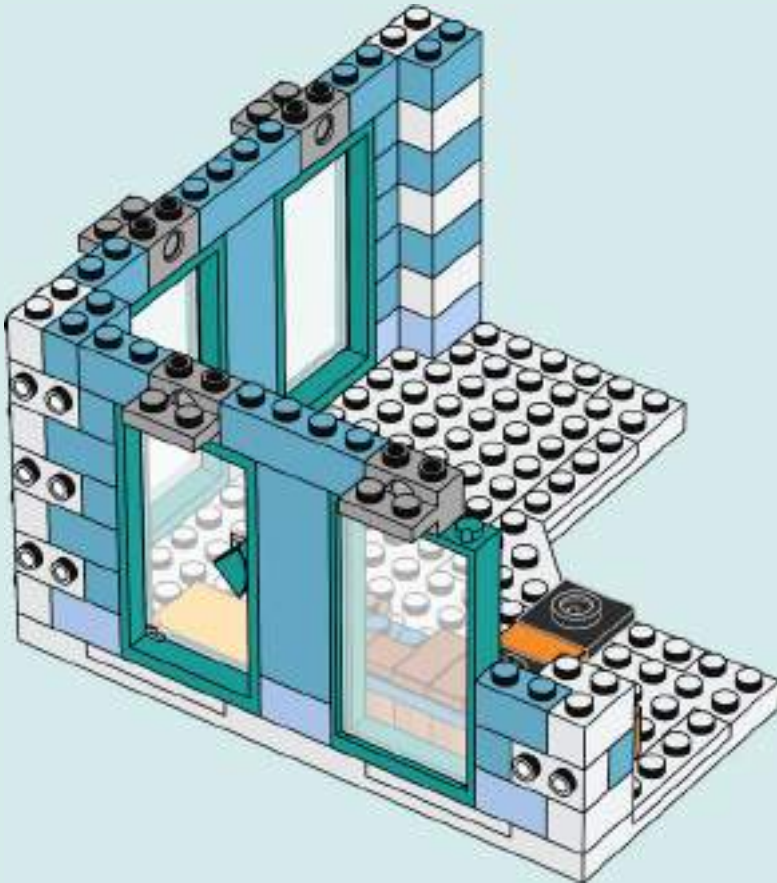



31

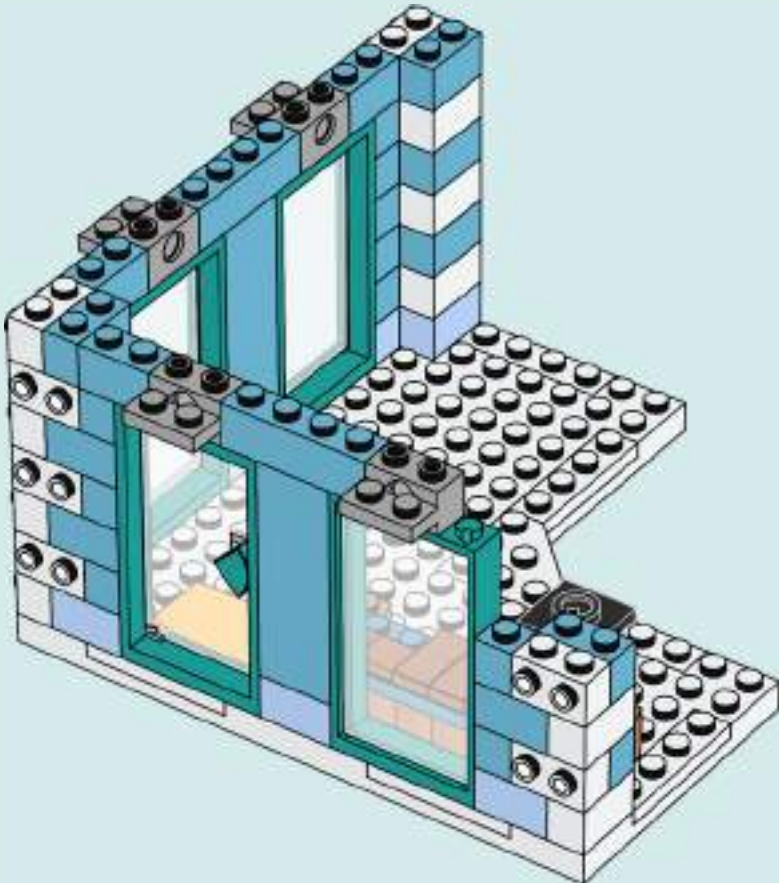

32

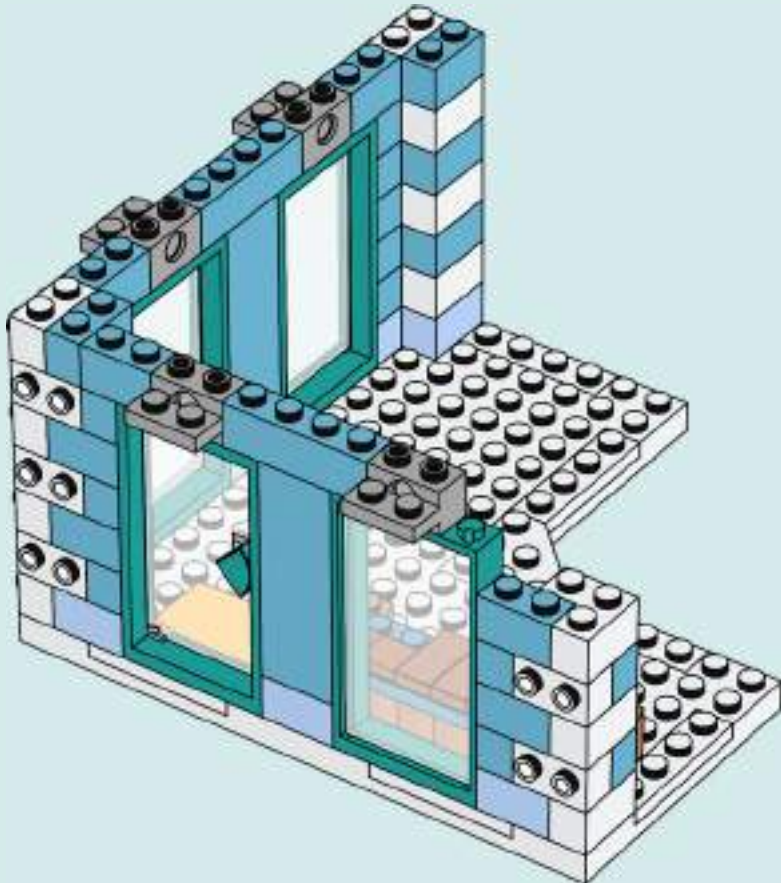





33

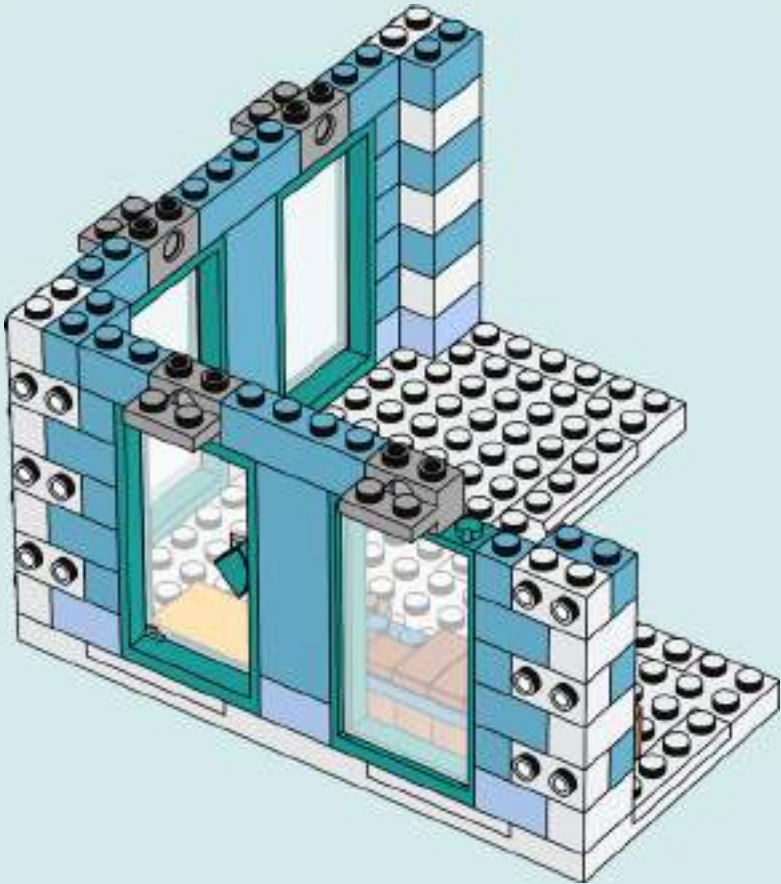

34

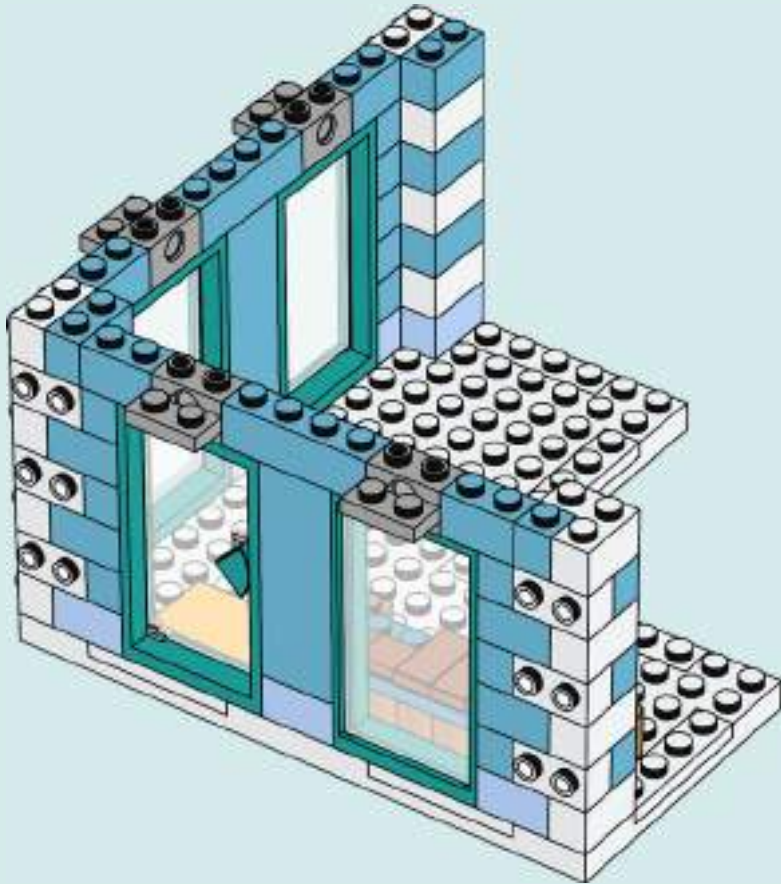

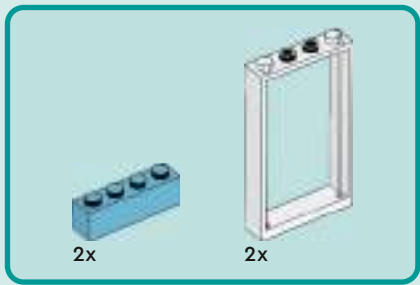

35

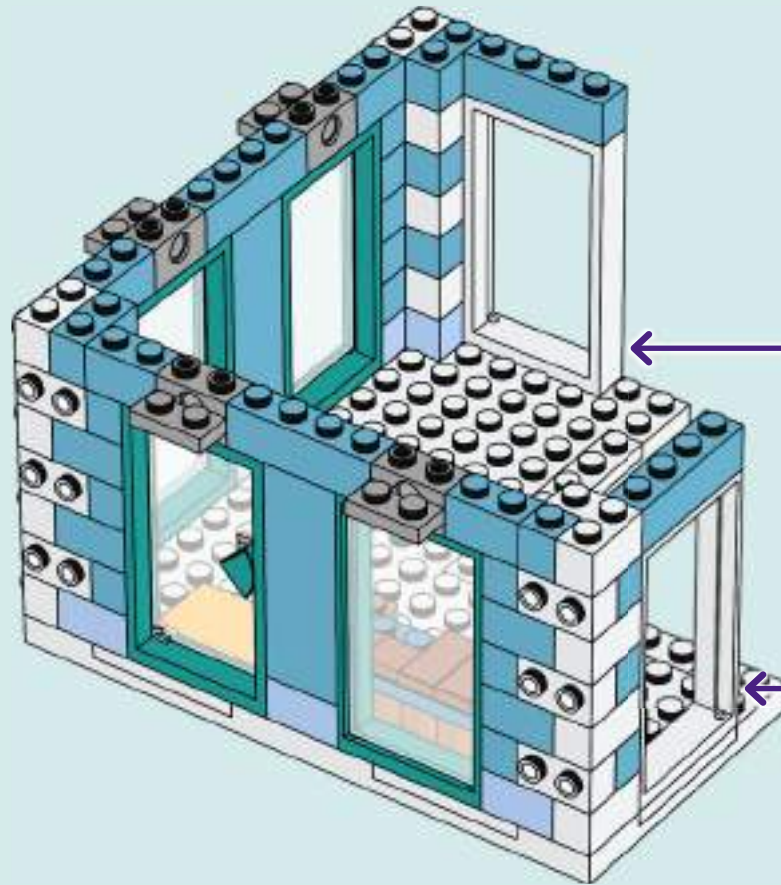
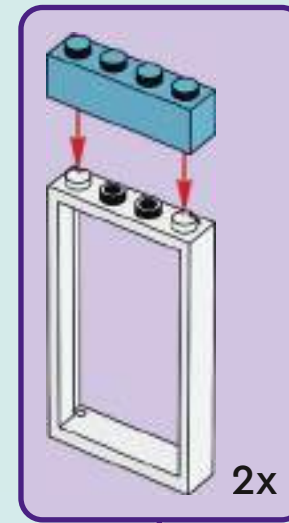



36

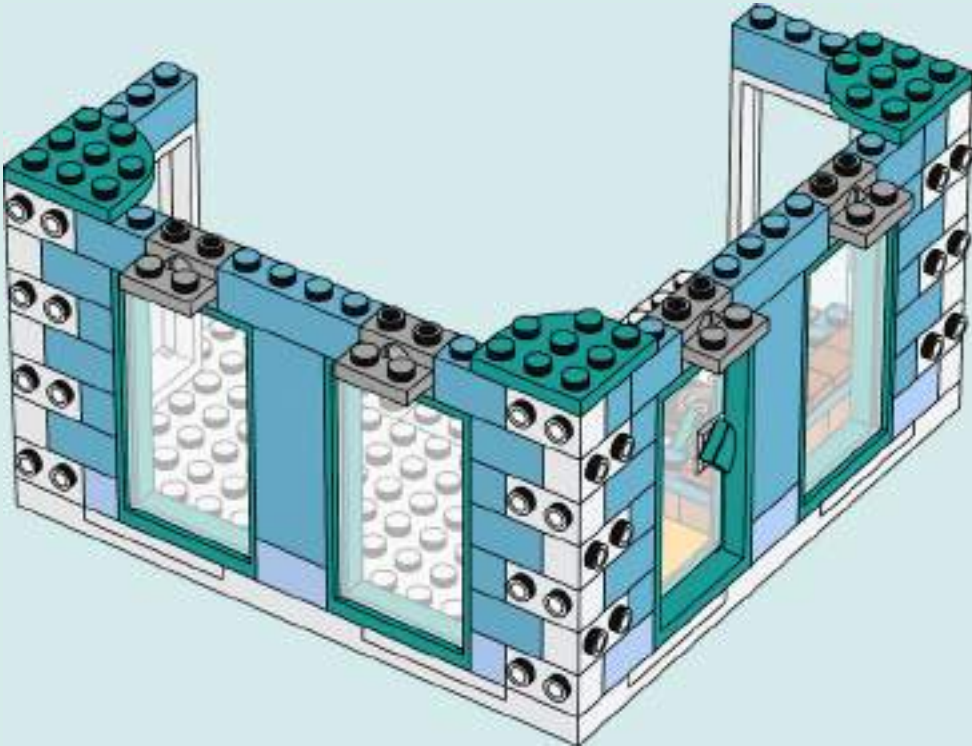



8x

37

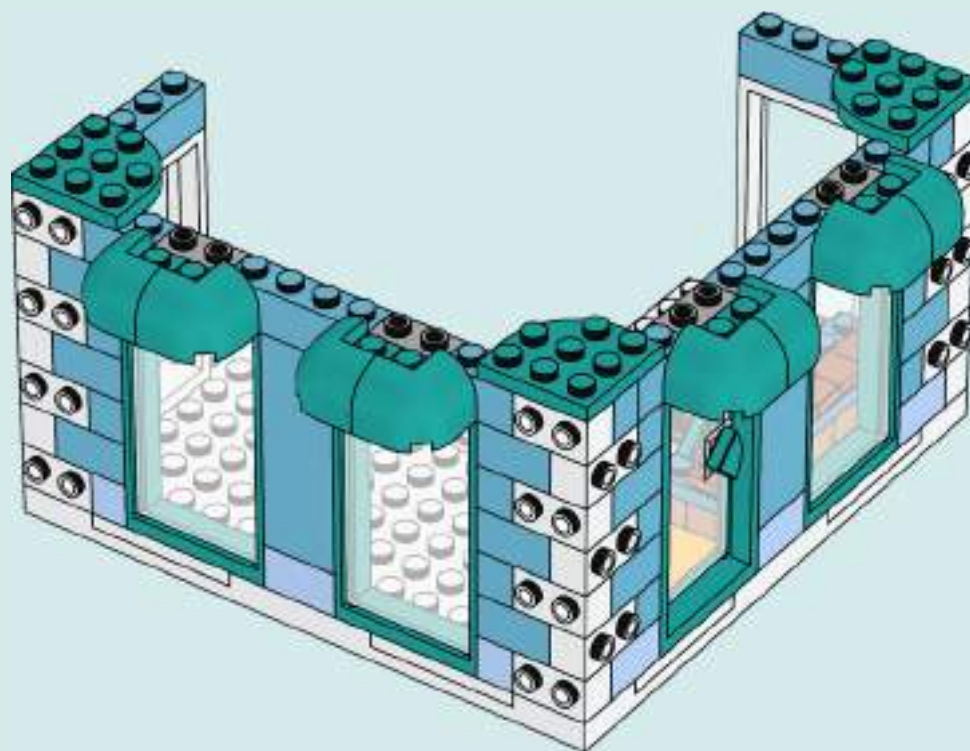



8x

38

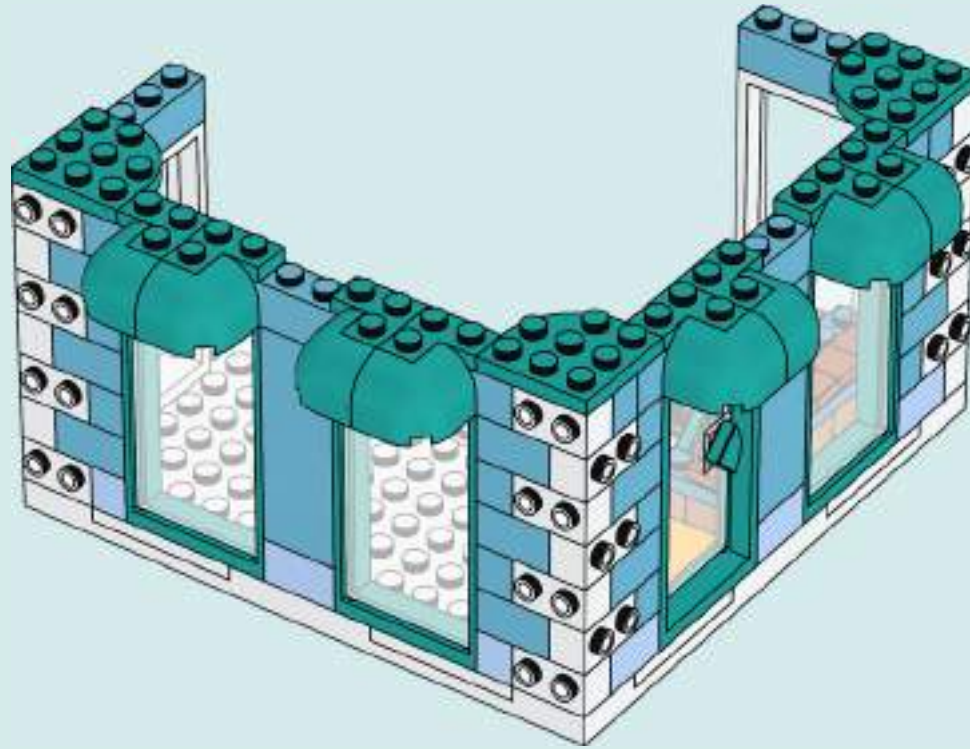



2x



2x

39

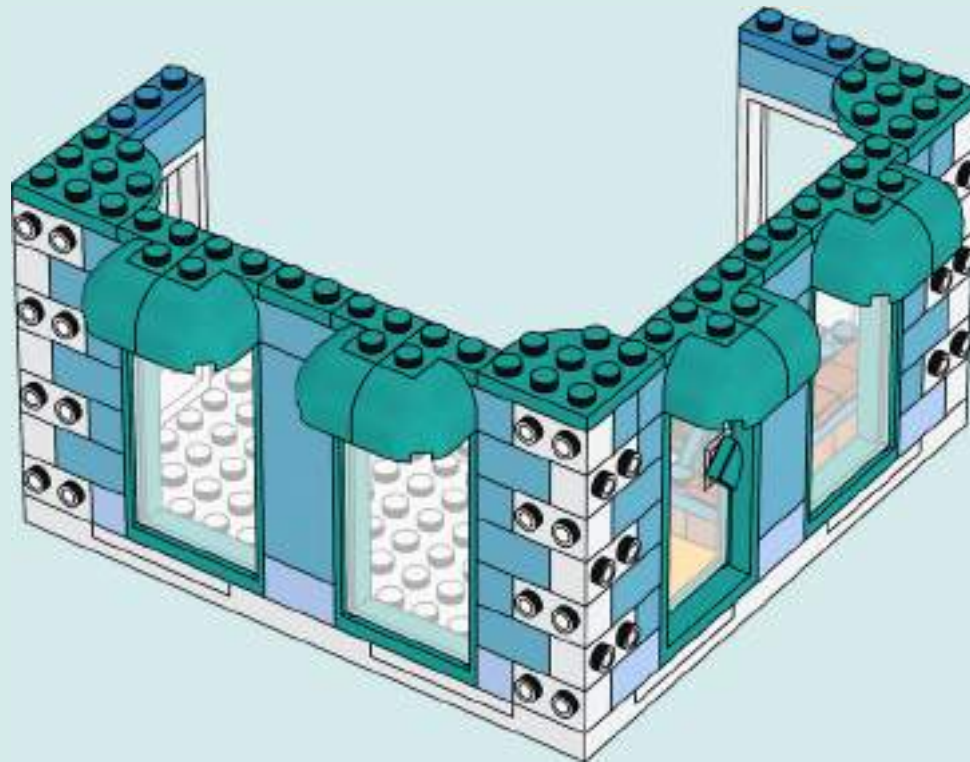



3x

40

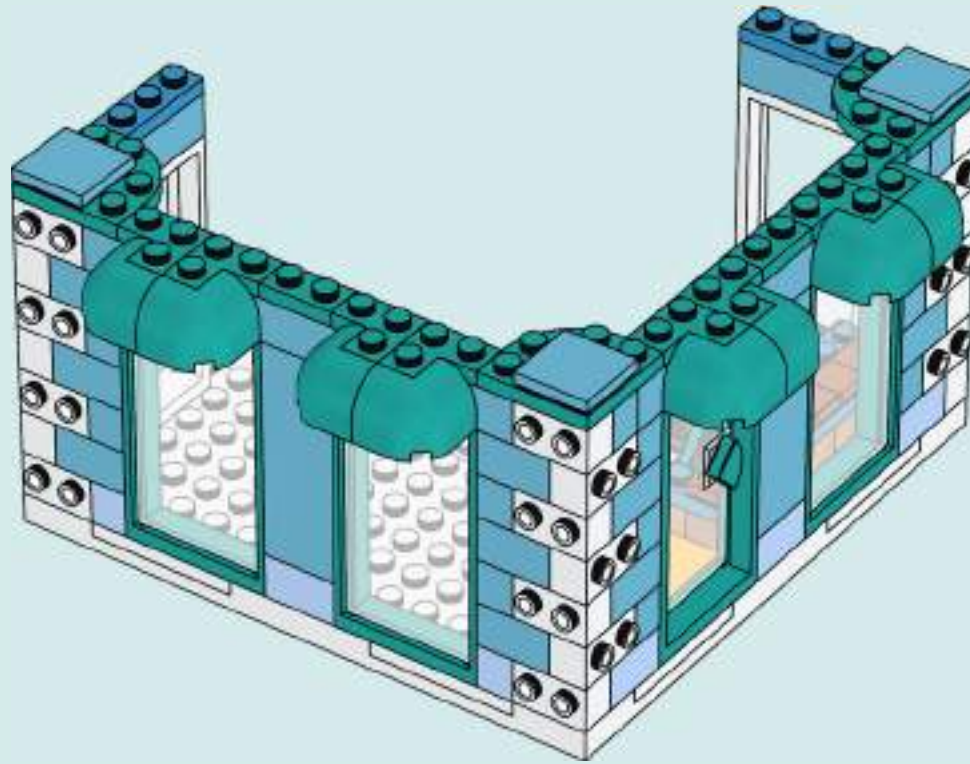

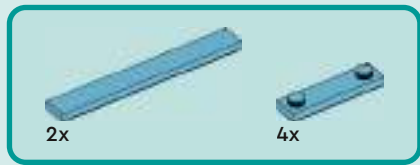

41

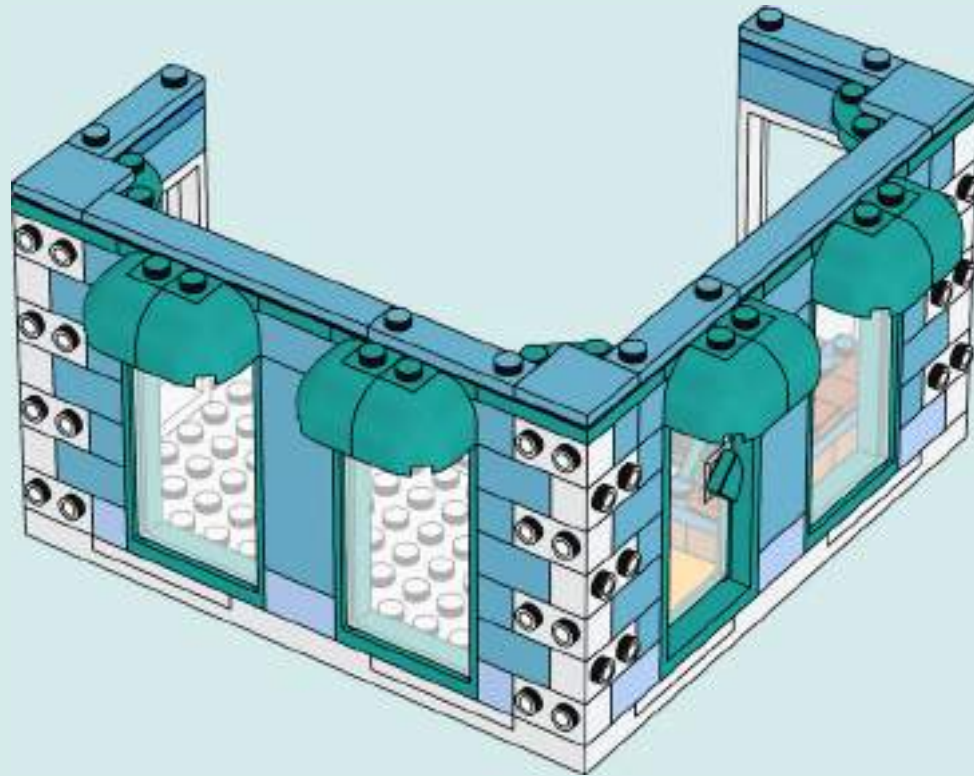





1

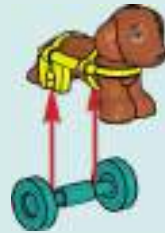

2

**PICKLE**



# NOVA

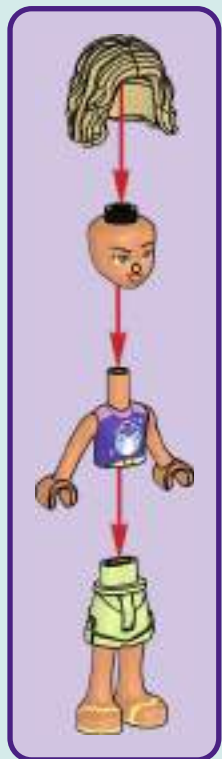

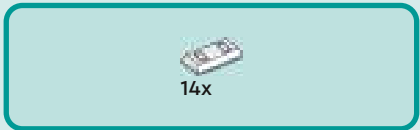

42

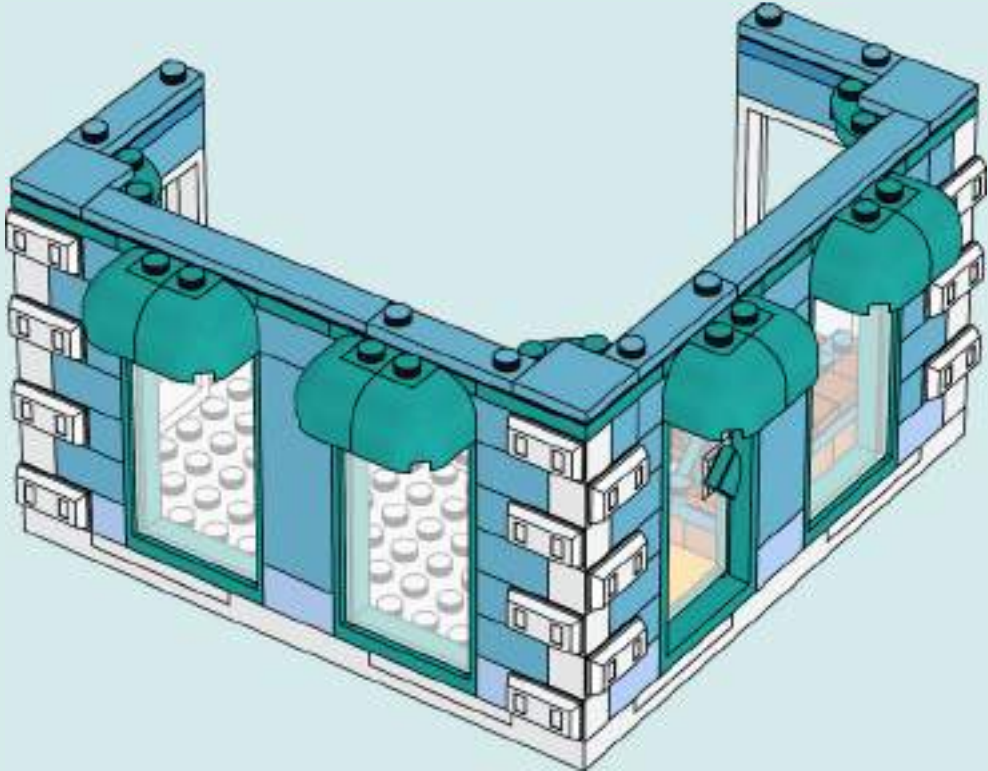



4x

43





44

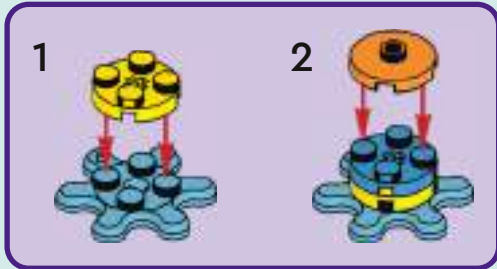



1x



1x

# 45

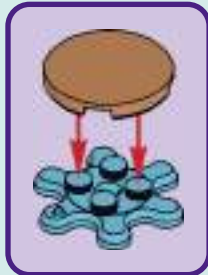
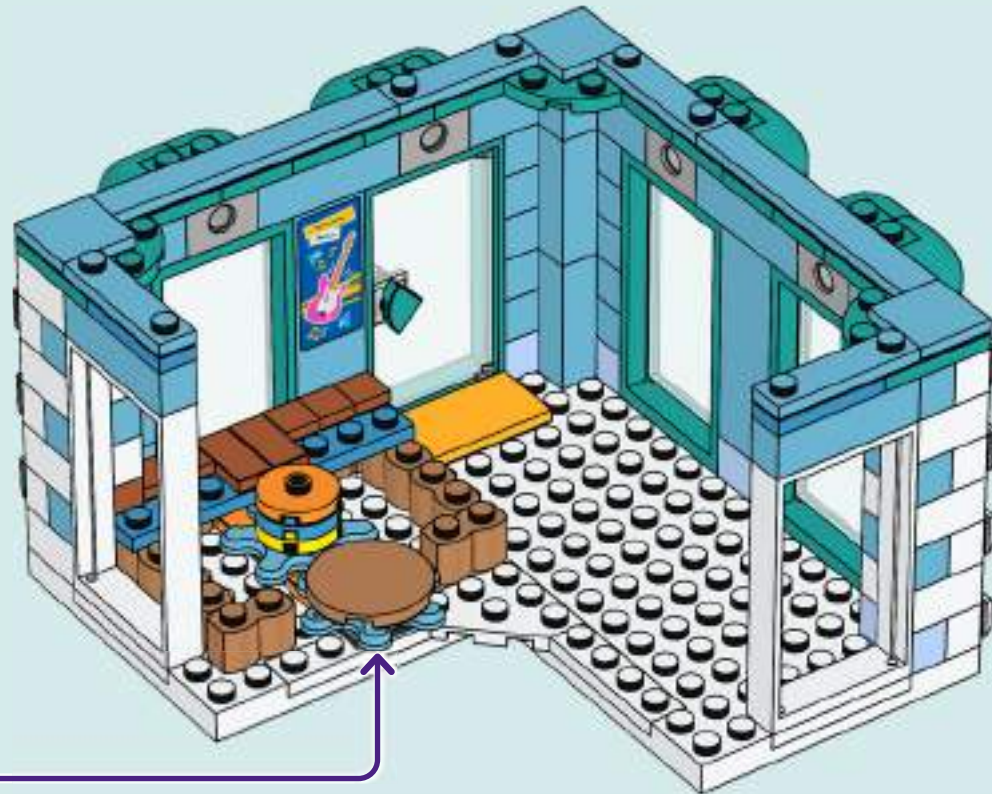



46

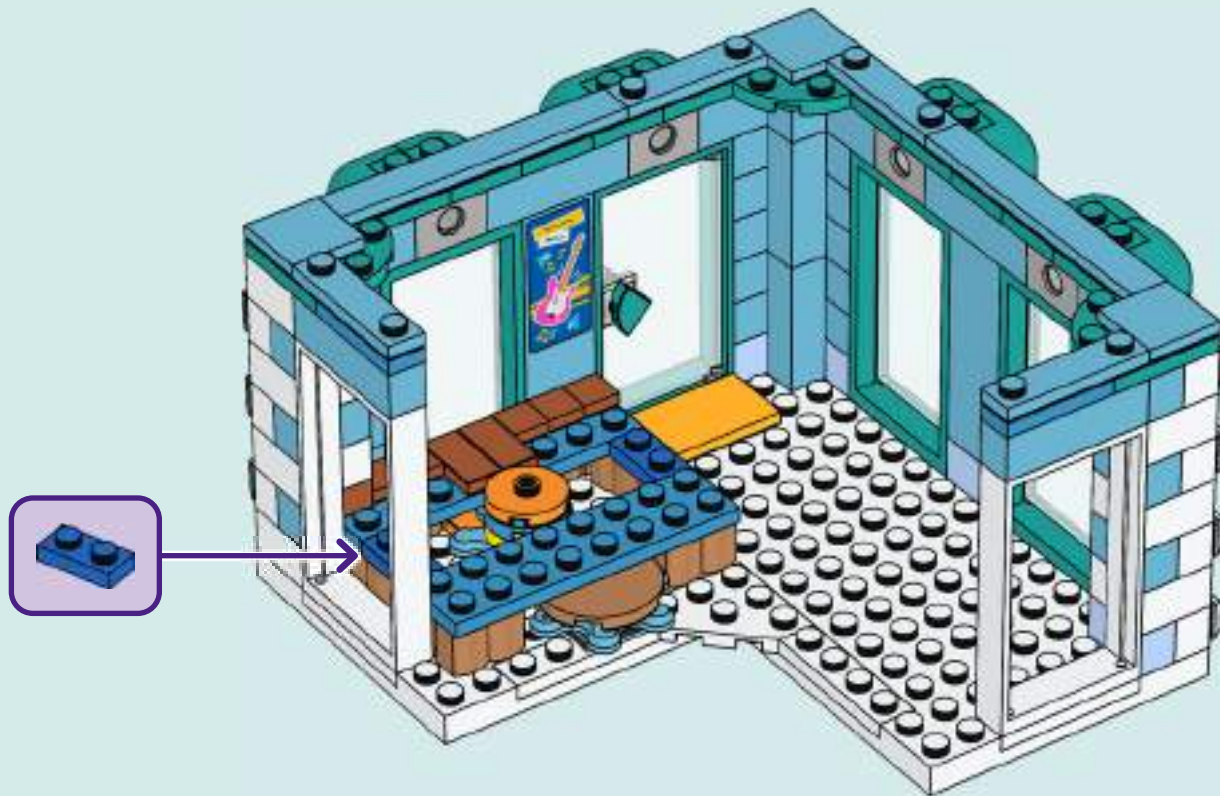

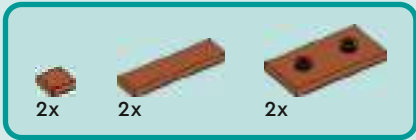

47

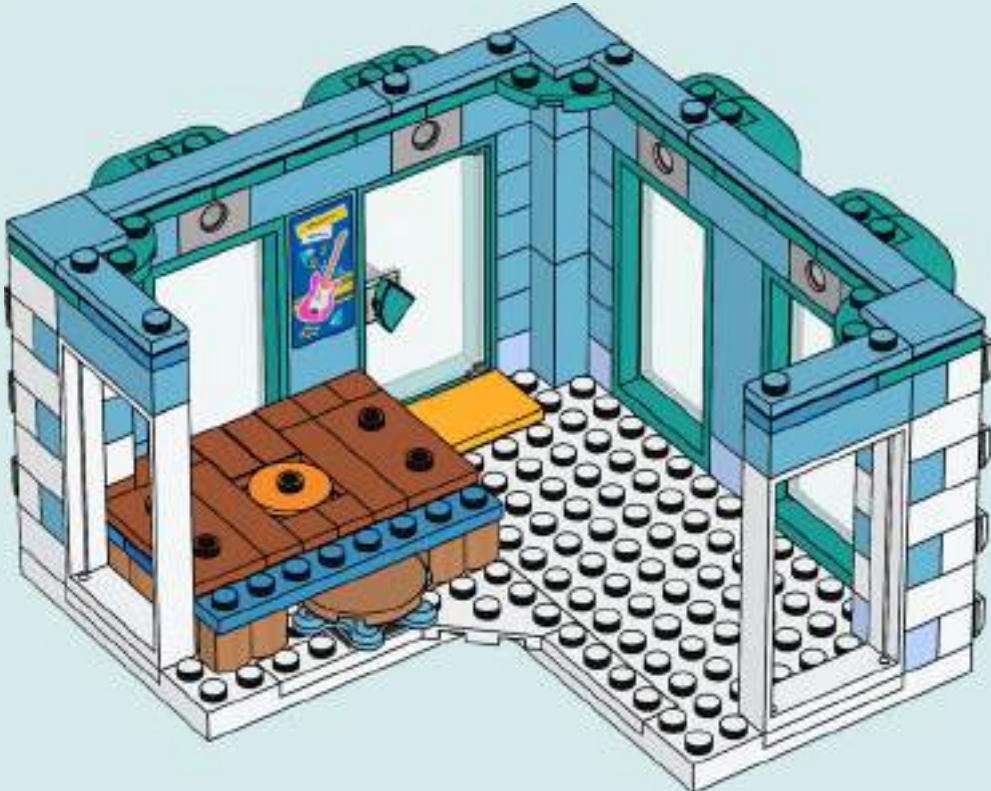





2x



3x

48

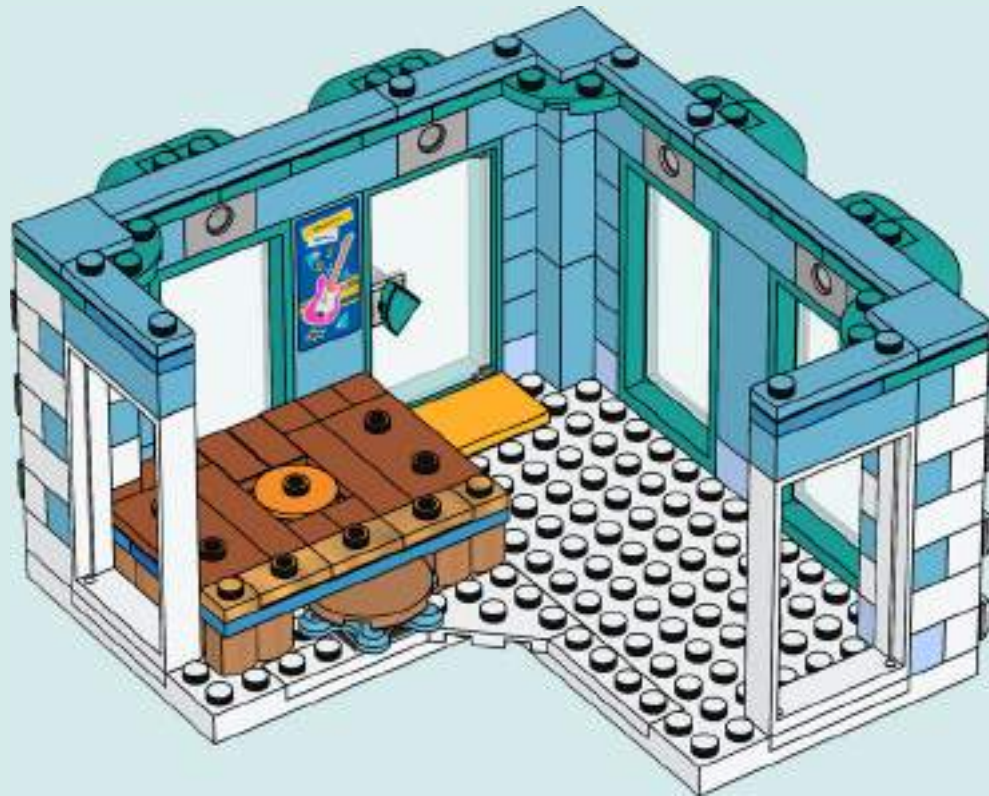



1x



4x

49

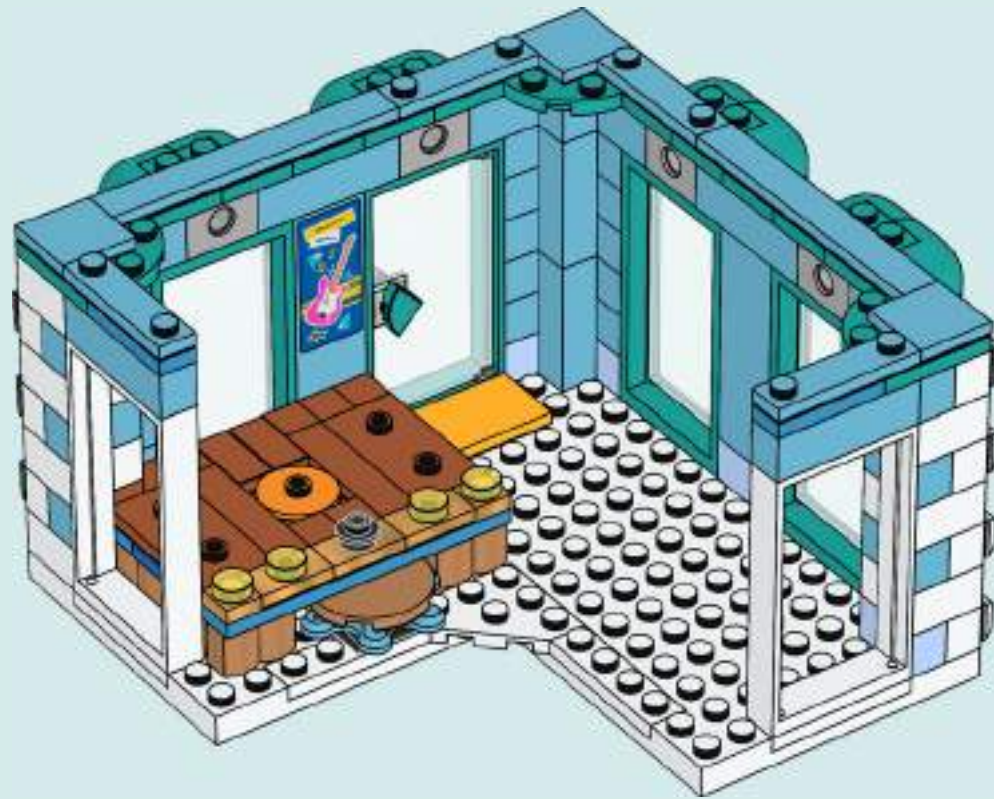

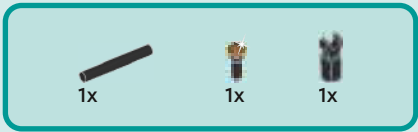

50

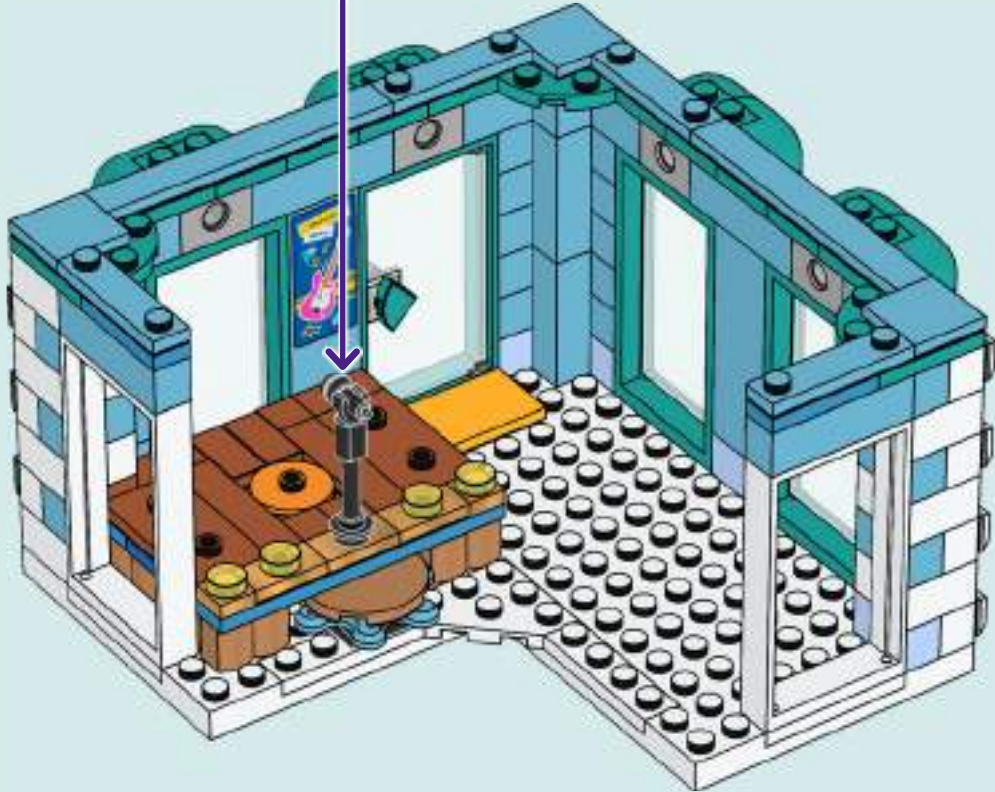

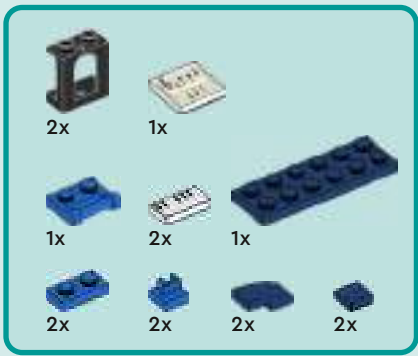

# 51

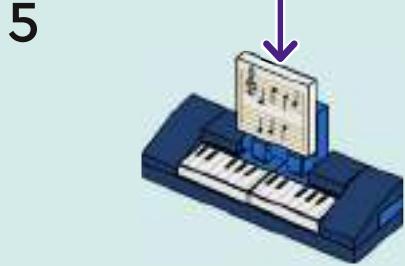
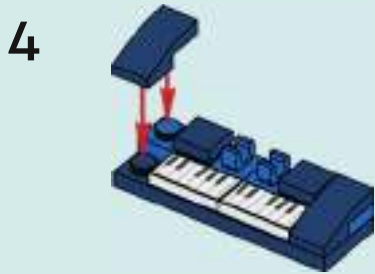
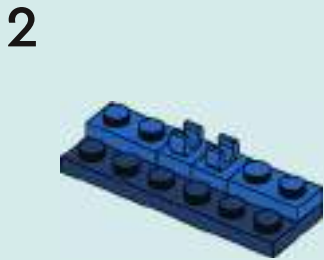
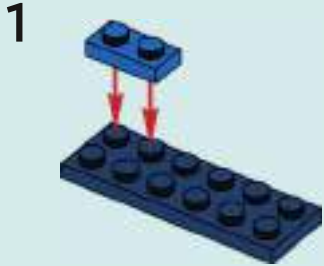

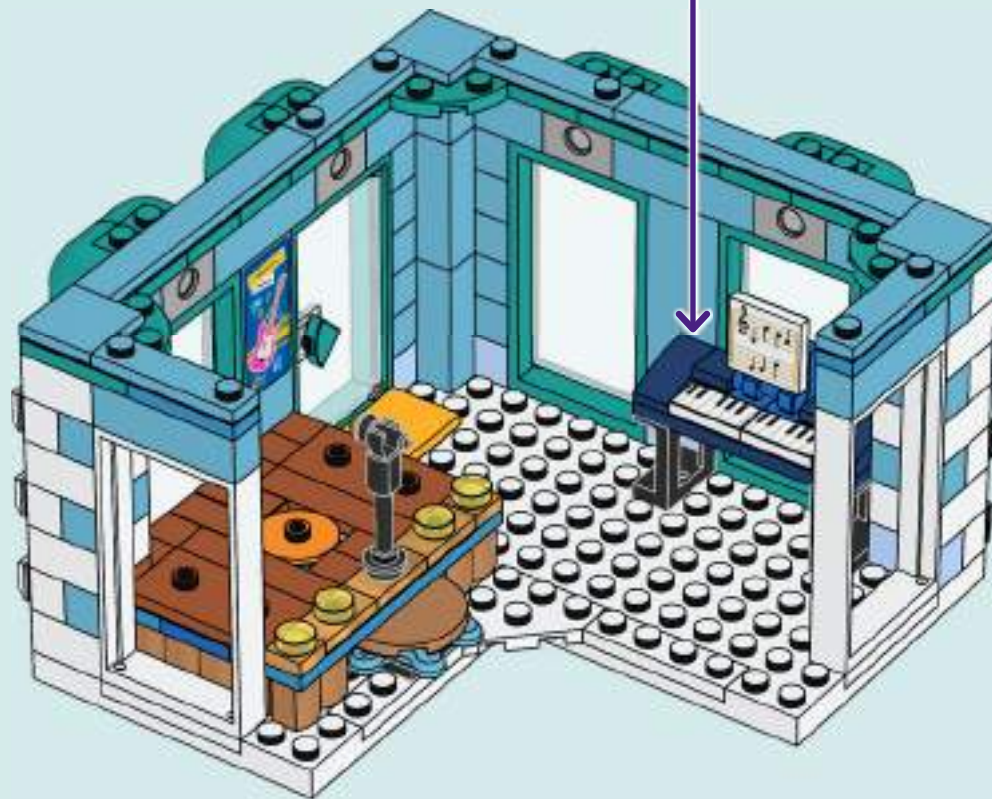



52

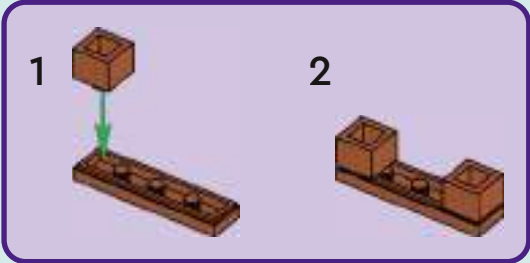



53

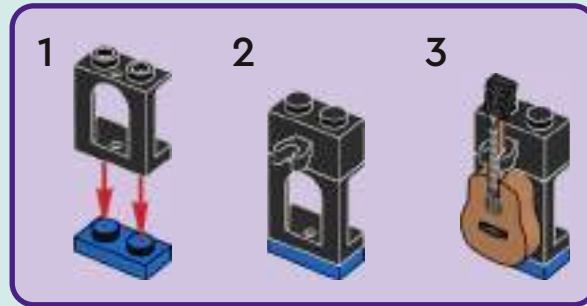

54

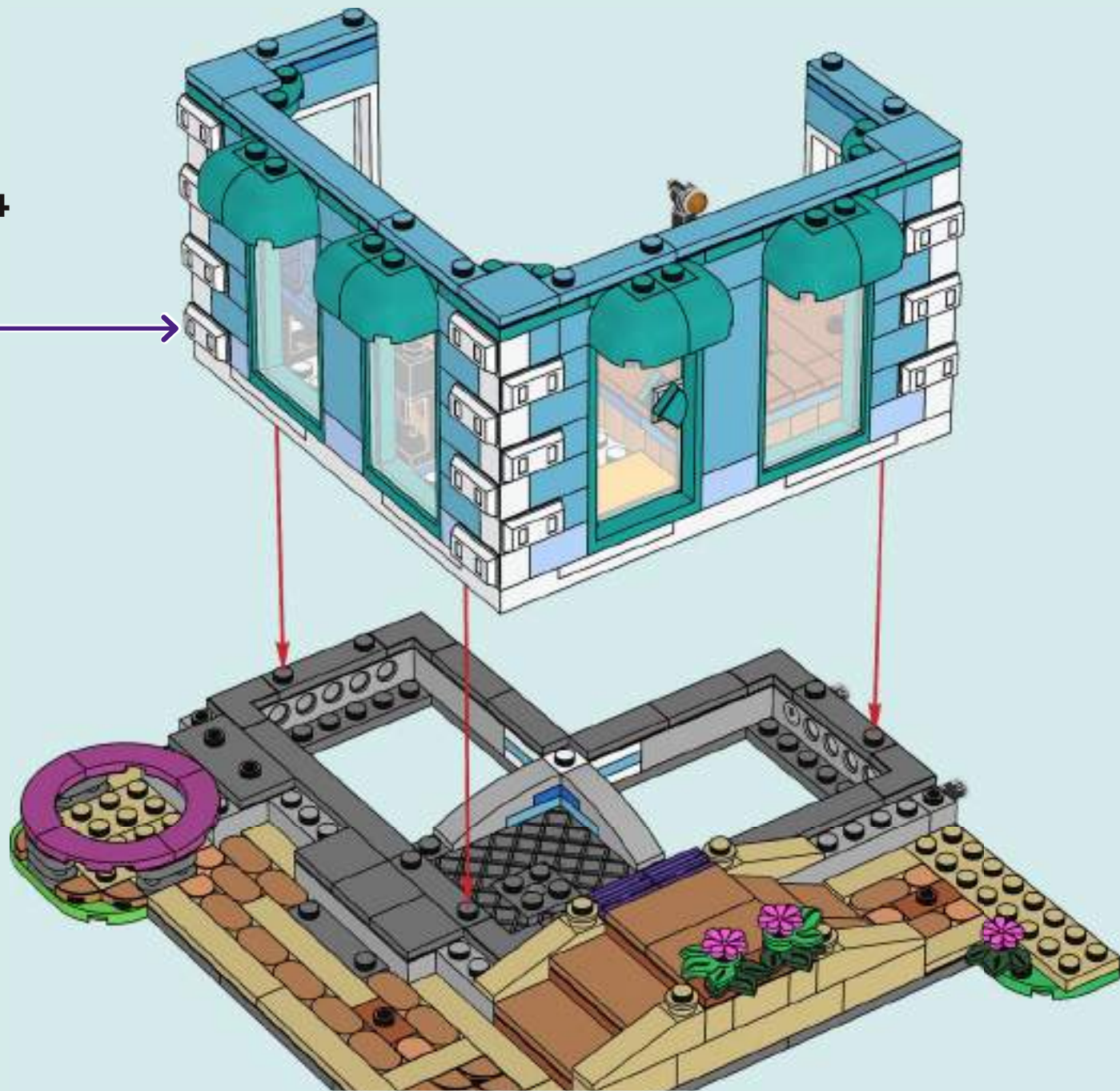





2x

55



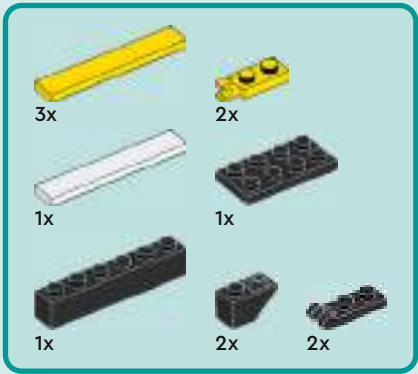

56

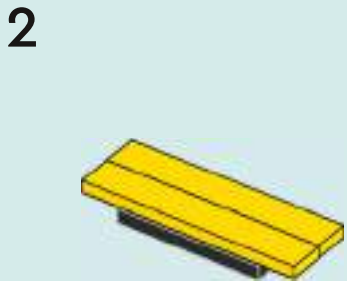
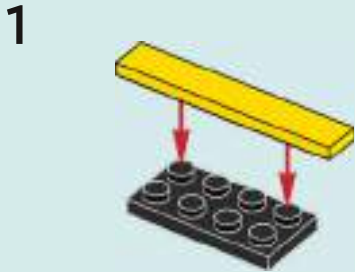

3

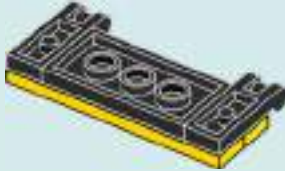

4

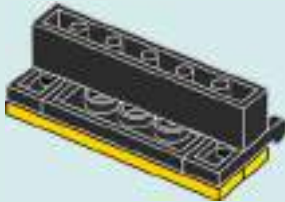

5

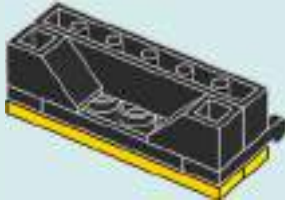

1

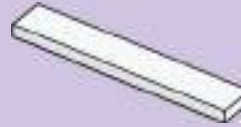

3



2

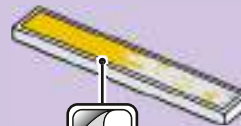

4

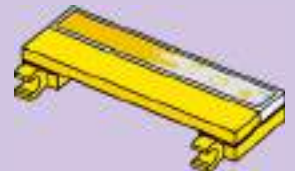

6

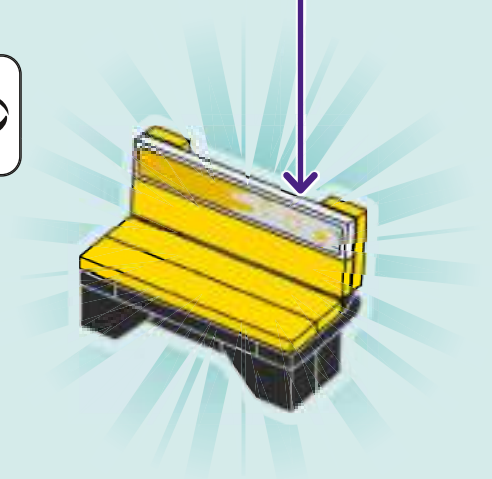

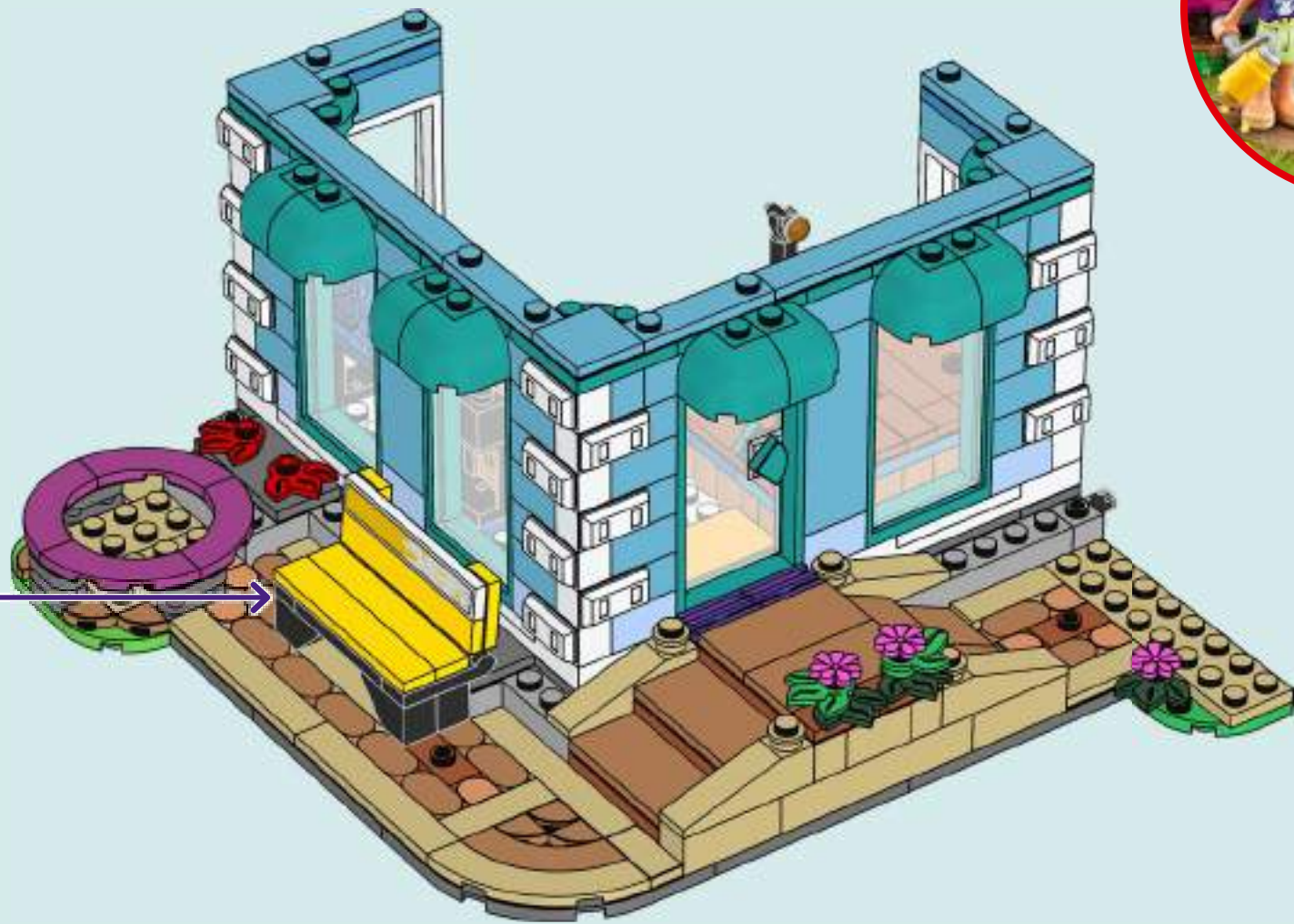

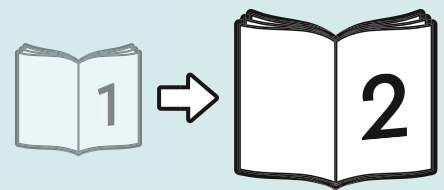



# Friends

41745



41747



41744



41749



41748





# Friends

AUTUMN

ALTYA

PAISLEY

ZAC



LEO

LIANN

OLLY

NOVA



**YOU COULD WIN**



Scan this QR code or go to **LEGO.COM/PRODUCTFEEDBACK** and give us your short feedback about this LEGO® set for a chance to win a cool LEGO prize.

Terms and Conditions apply\*



**EN: YOU COULD WIN.** Terms and Conditions apply\* **DE: Du könntest GEWINNEN.** Es gelten die Teilnahmebedingungen\* **FR: Tu pourrais GAGNER.** Des conditions s'appliquent\* **IT: Potresti VINCERE tu.** Termini e condizioni sono applicabili\* **ES: Puedes GANAR.** Aplican términos y condiciones\* **PT: Poderá GANHAR.** Aplicam-se termos e condições\* **ZH: 轻松获奖. 条款和条件适用\*** **PL: Szansa na WYGRANĄ.** Obowiązują warunki korzystania\* **CS: Máte šanci VYHRÁT.** Platí všeobecné smluvní podmínky\* **SK: Máte šancu VYHRAŤ.** Platia všeobecné zmluvné podmienky\* **HU: TE IS NYERHETSZ.** Felhasználási feltételek érvényesek\* **RO: Ai putea CÂȘTIGA.** Se aplică termenii și condițiile\* **BG: Можете да СПЕЧЕЛИТЕ.** Има определени правила и условия\* **LV: Tu vari LAIMĒT.** Ir spēkā noteikumi un nosacījumi.\* **ET: Sul on võimalus VÕITA.** Kehtivad tingimused\* **LT: Jūs galite LAIMĖTI.** Taikomos sąlygos\*

\*[LEGO.com/productfeedback-terms](https://www.lego.com/productfeedback-terms)

LEGO, the LEGO logo and the FRIENDS logo are trademarks of the LEGO Group. ©2023 The LEGO Group.