

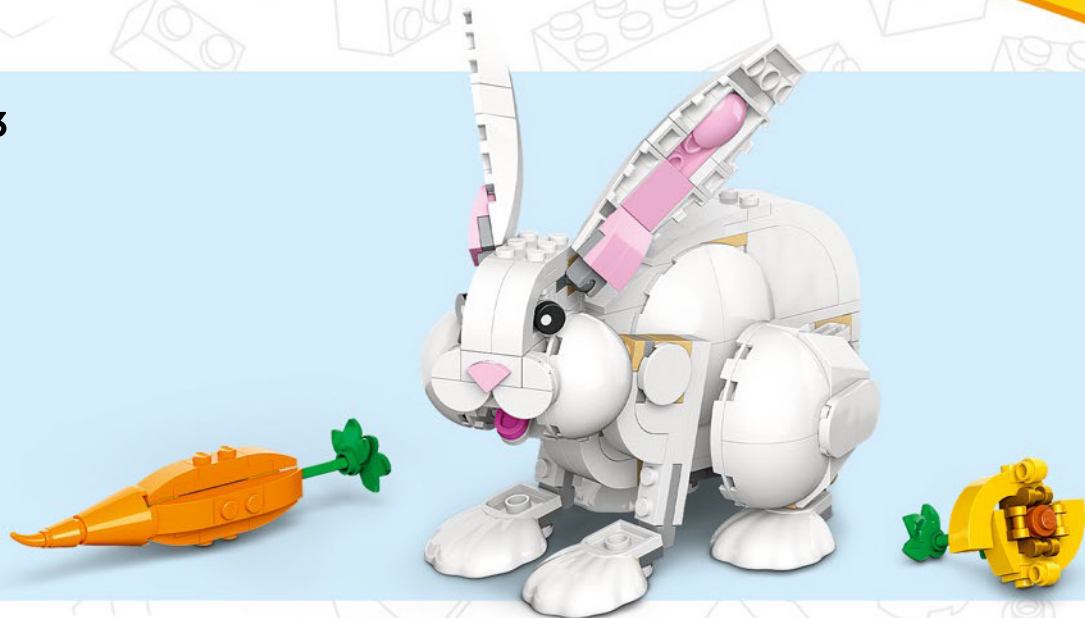

# CREATOR™



31133



3 in 1	3 合 1	3 v 1	„3 в 1“
3 en 1	3 в 1	3 az 1-ben	Kolm ühes
3 em 1	3 w 1	3 în 1	3 viename



[LEGO.com/sustainable-packaging](https://LEGO.com/sustainable-packaging)



# BUILDER



Apple and the Apple logo are trademarks of Apple Inc., registered in the U.S. and other countries and regions. App Store is a service mark of Apple Inc. Google Play and the Google Play logo are trademarks of Google LLC. Tencent and the Tencent logo are trademarks of Tencent Inc.

Q [LEGO.com/devicecheck](https://www.lego.com/devicecheck)

**EN** Ask parents' permission before going online | **DE** Eltern um Erlaubnis bitten, bevor du online gehst | **FR** Demande l'autorisation d'un parent avant d'aller en ligne | **IT** Chiedi il permesso ai tuoi genitori prima di andare online | **ES** Pídeles permiso a tus papás antes de conectarte a Internet | **PT** Pede autorização aos pais antes de acederes online | **JA** オンラインになる前に ほか者の方のきよかをもらおう | **ZH** 上网前应先征得父母的同意 | **KO** 온라인 접속 전에 보호자 동의가 필요합니다 | **RU** Спроси разрешения у родителей, прежде чем заходить в интернет | **PL** Poproś rodziców o zgodę, zanim wejdziesz do Internetu | **CS** Než půjdeš na internet, požádej rodiče o svolení | **SK** Skôr než pôjdeš na internet, vypýtaj si povolenie od rodičov | **HU** Kérj szülői engedélyt, mielőtt online csatlakoznál! | **RO** Cere permisiunea părinților înainte de a te conecta online | **BG** Поискайте разрешение от родител, преди да влезете онлайн | **LV** Pirms došanās tiešsaistē palūdz atļauju vecākiem | **ET** Enne Interneti kasutamist küsi vanematelt luba | **LT** Prieš prisijungdami prie interneto, atsklauskite tėvų



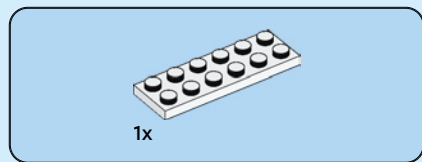

1

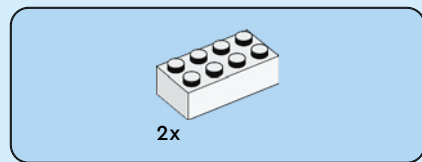
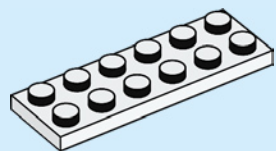

2

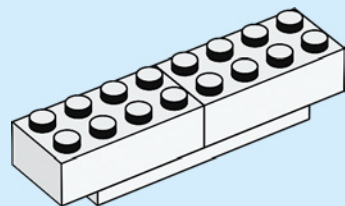



1x



1x

3

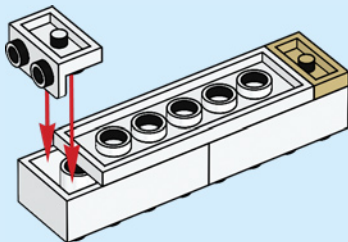
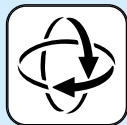

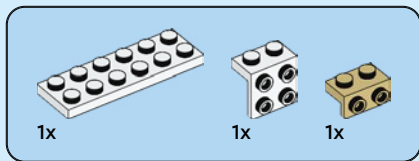

4

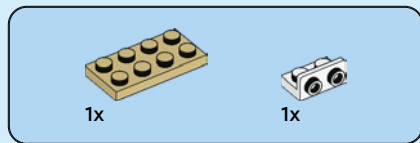
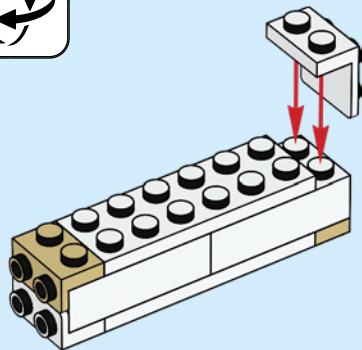
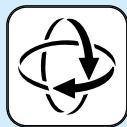

5

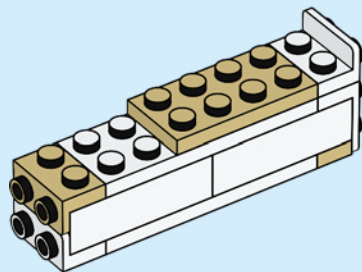



1x



1x



2x

6

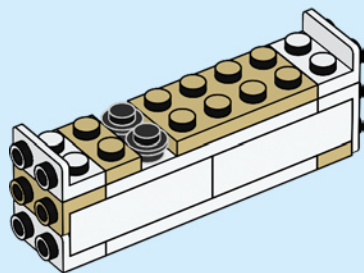

2x

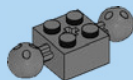

1x

7

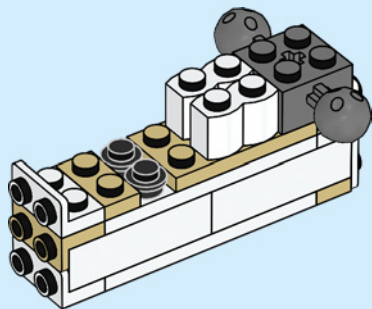





2x



1x

8

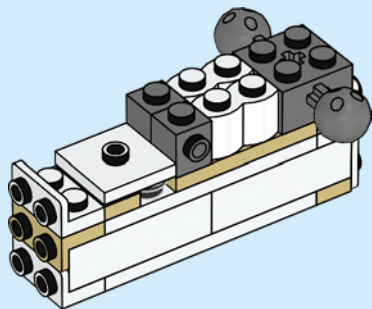

2x



1x

9

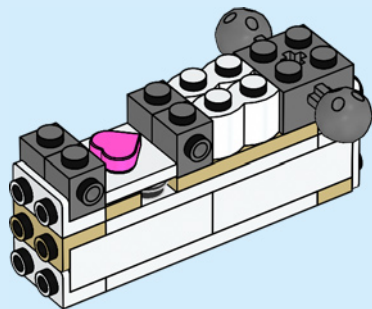

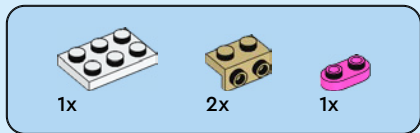

10

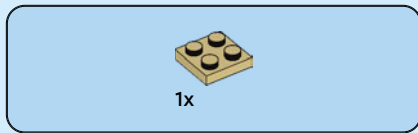
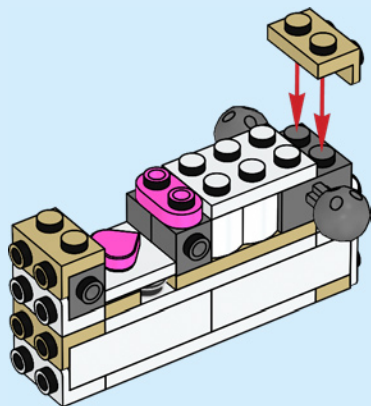

11

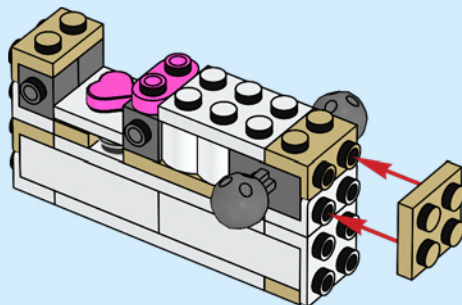



1x



1x

12

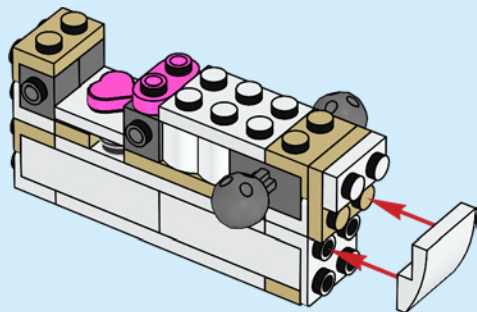

1x

13

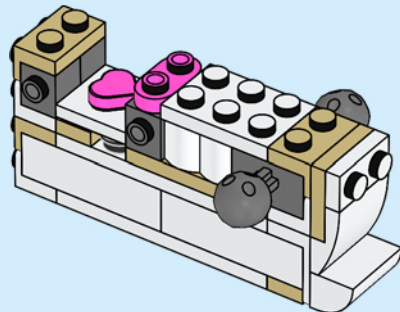

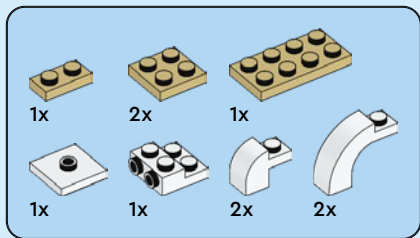

14

1

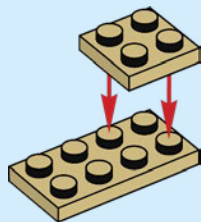

2

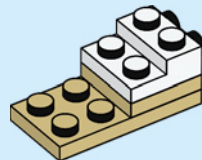

3

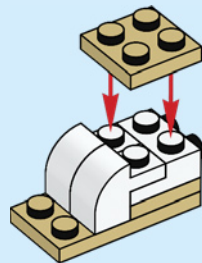

4

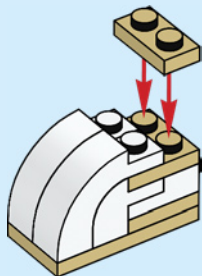

5

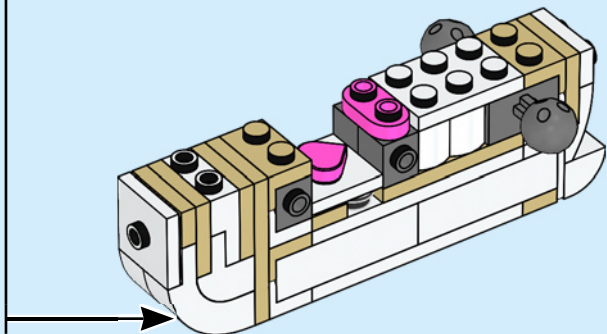
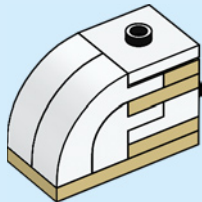

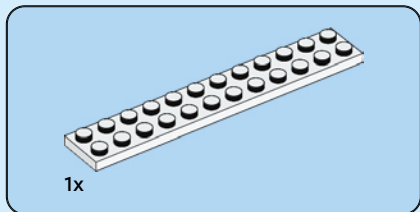
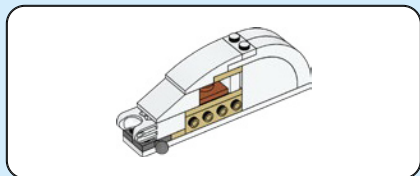

15

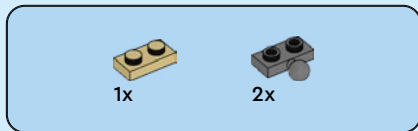
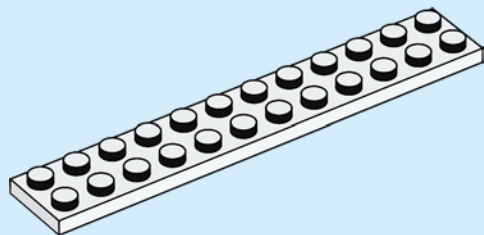

16

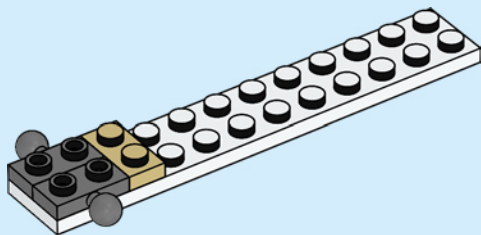

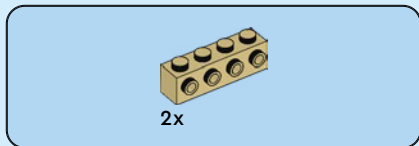

17

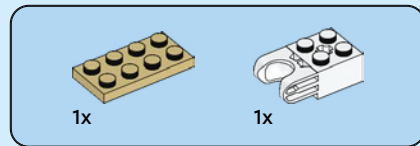
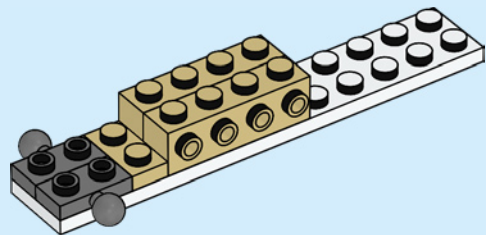

18

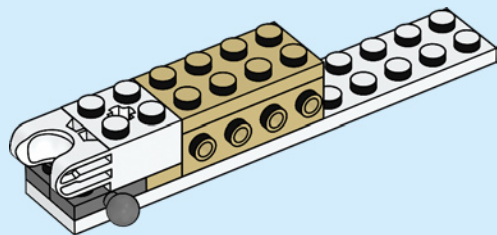

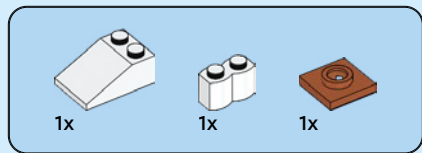

19

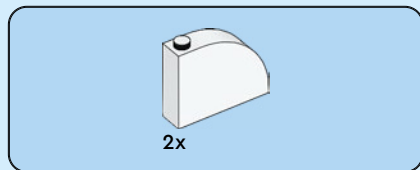
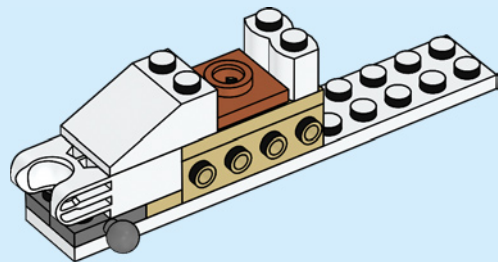

20

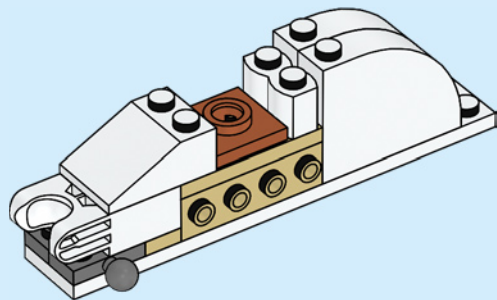





1x

21

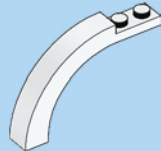
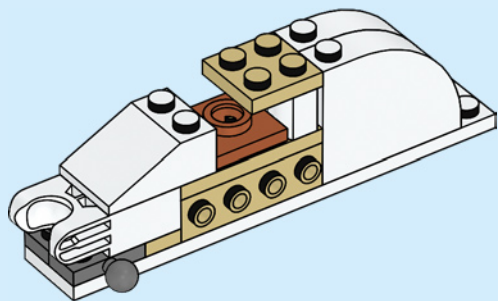

2x

22

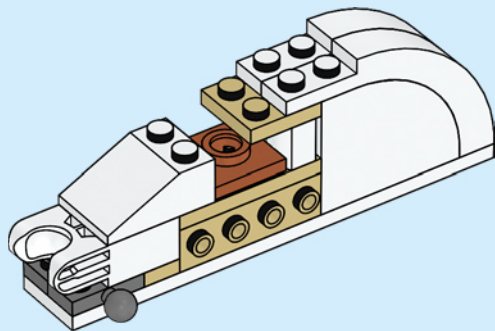

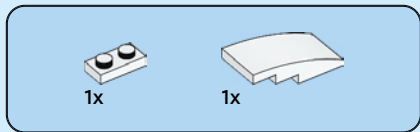

23

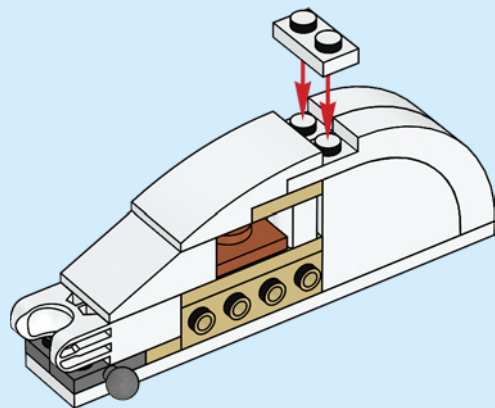

24

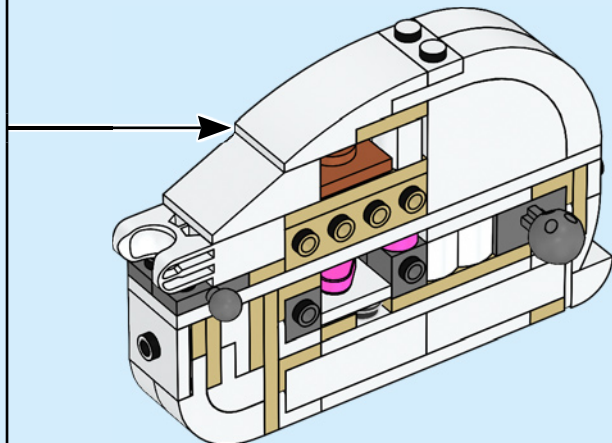



1x

25

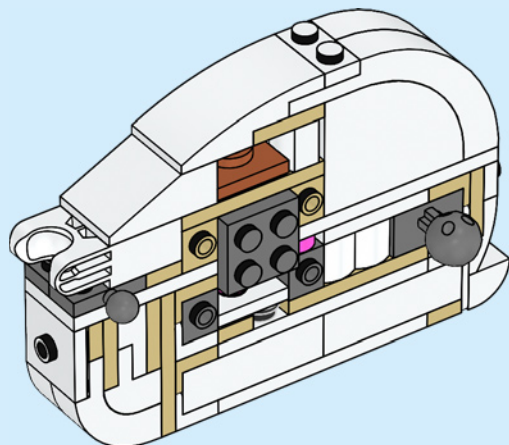

2x

26

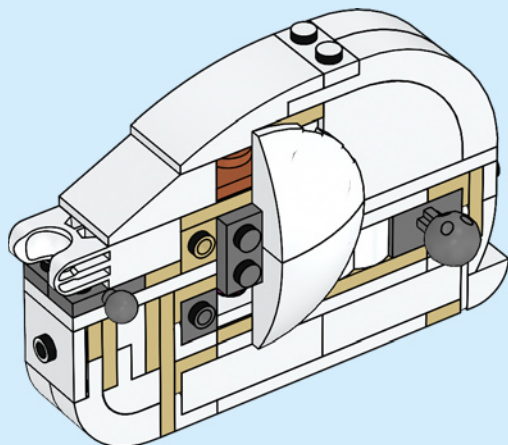



2x

27

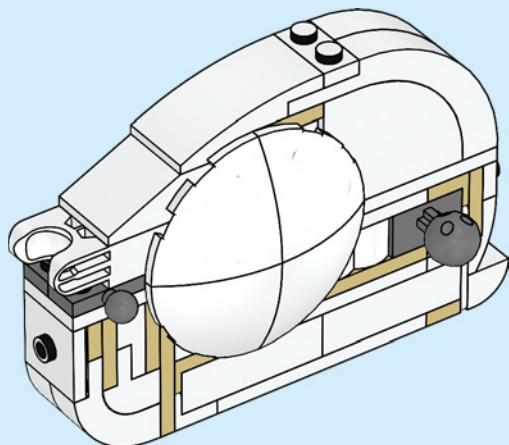

1x

28

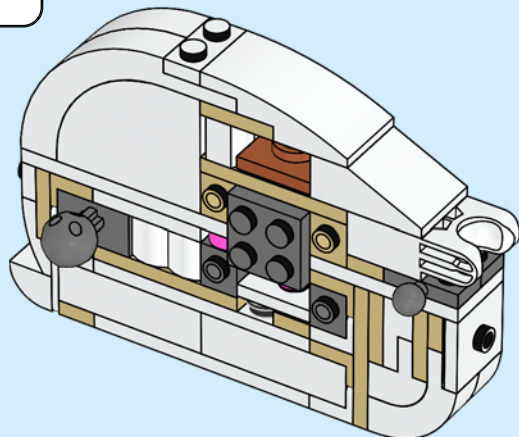



2x

29

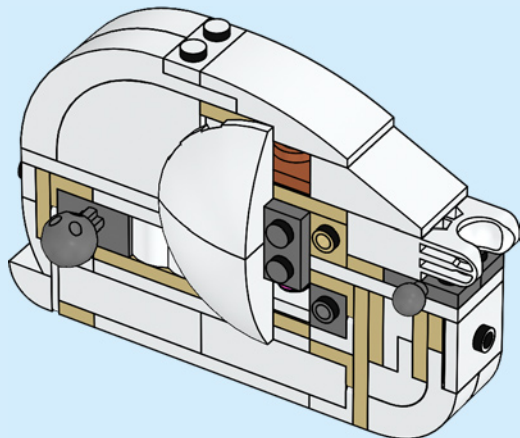

2x

30

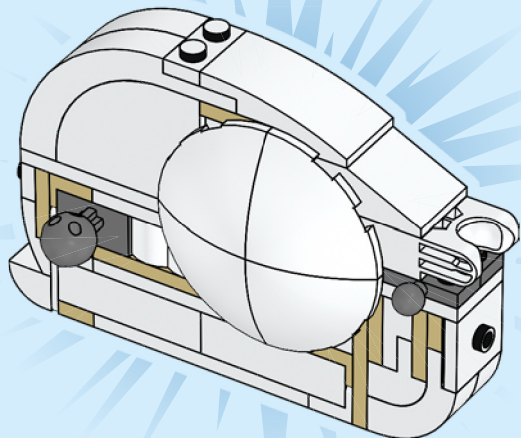

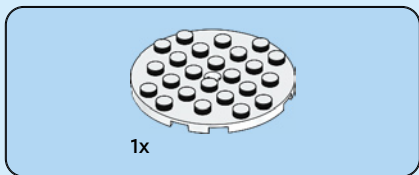
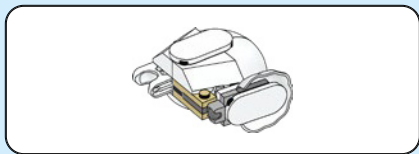

31

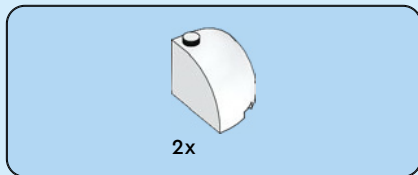
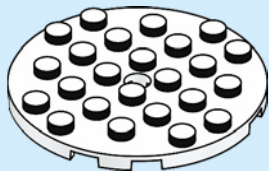

32

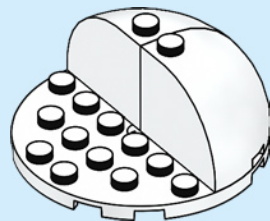



1x



1x



1x

# 33

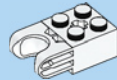
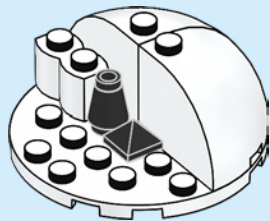

1x

# 34

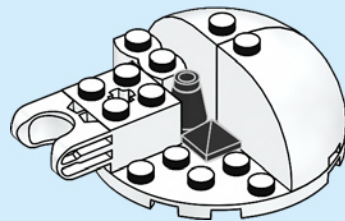



2x



1x



1x

# 35

1



2

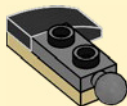

3

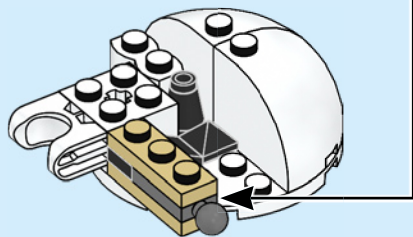
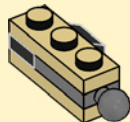

1x

# 36

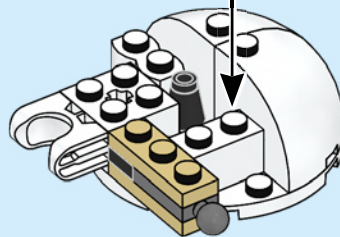
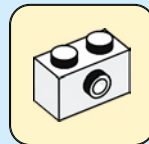





1x



1x

# 37

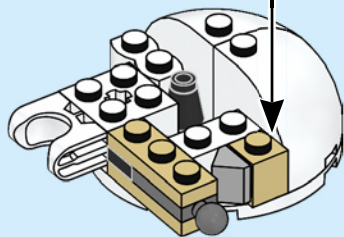
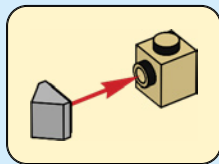

1x



1x

# 38

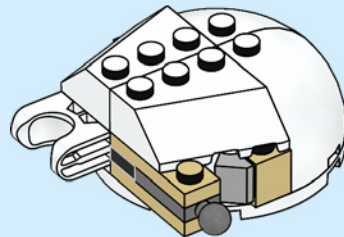



1x

39

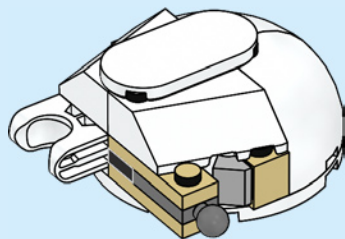

1x

40

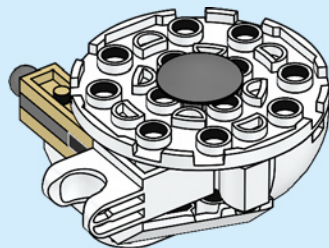

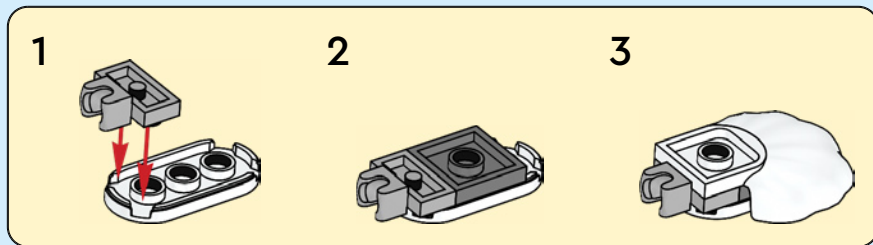
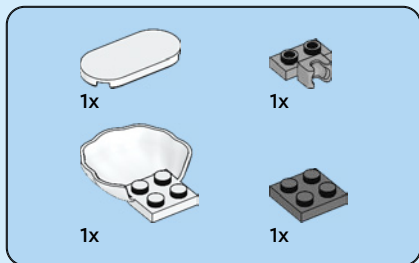

41

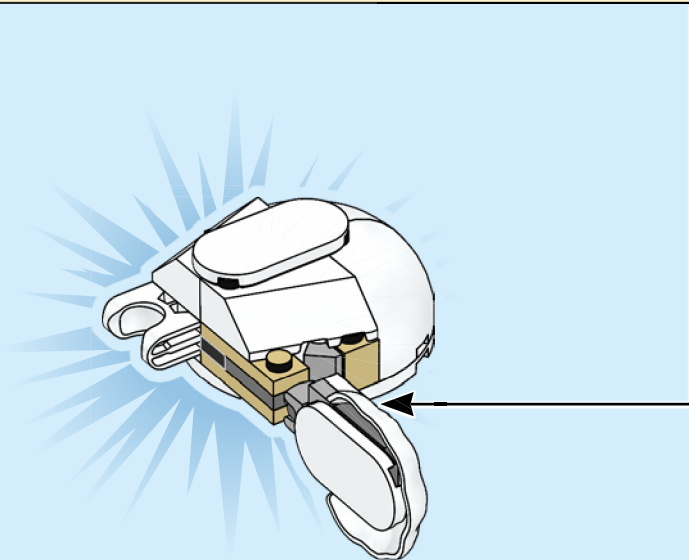
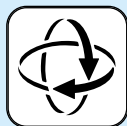

42

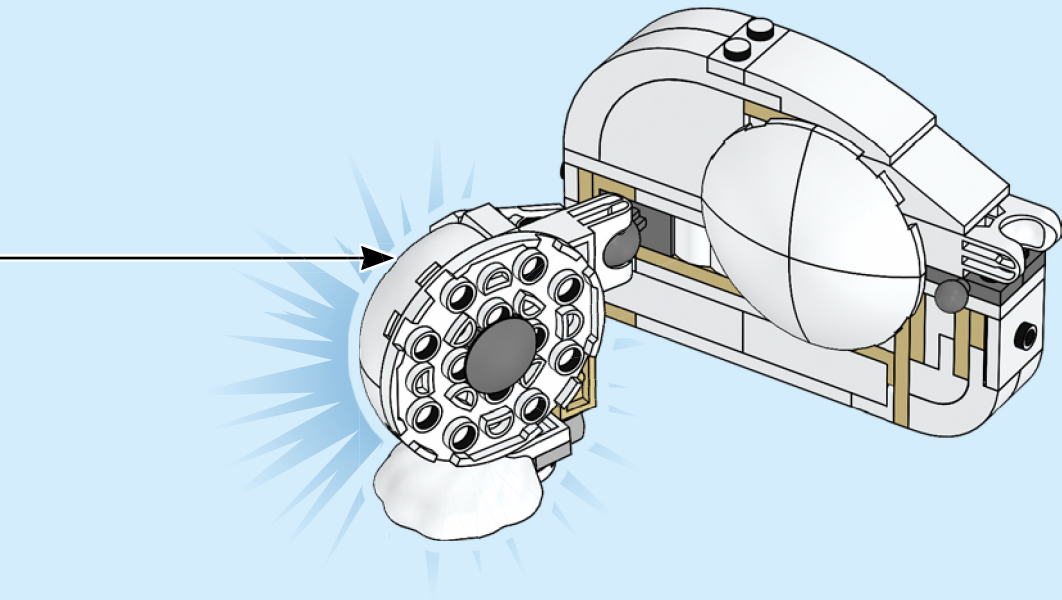

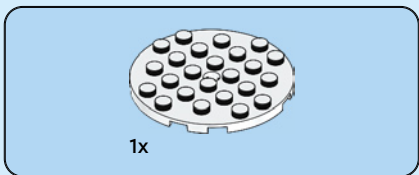
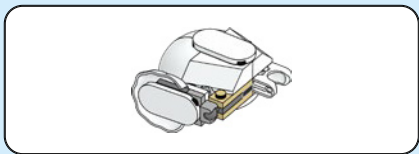

43

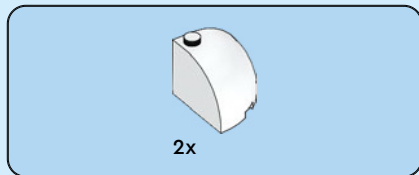
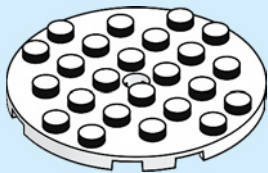

44

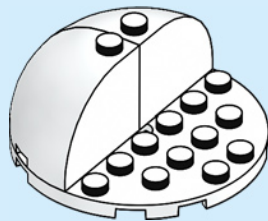



45

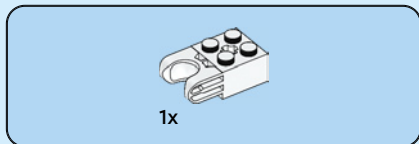
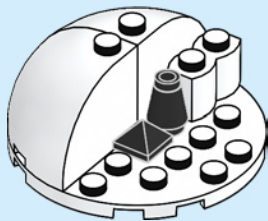

46

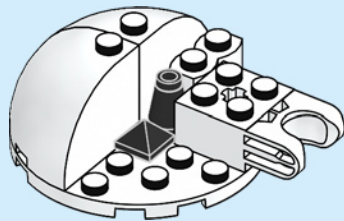

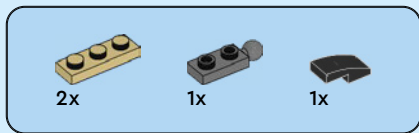

47

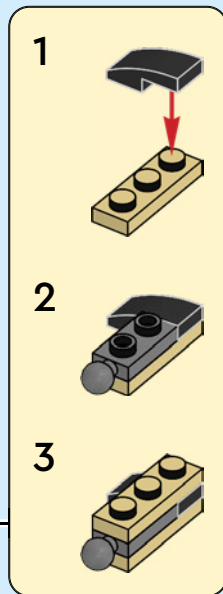
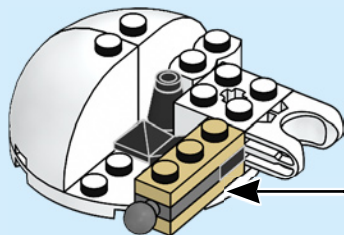



1x

48

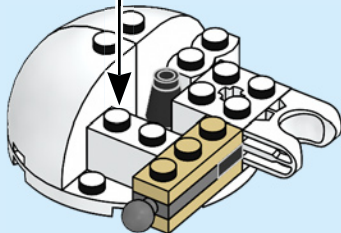
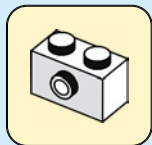

1x



1x

49

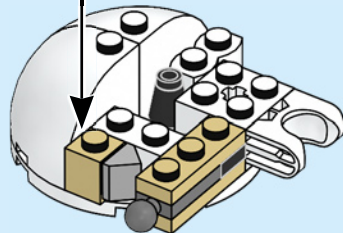
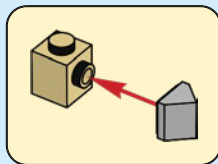



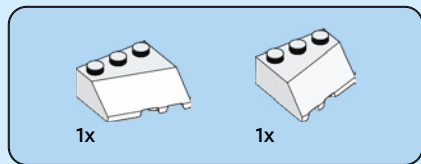

50

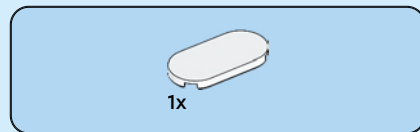
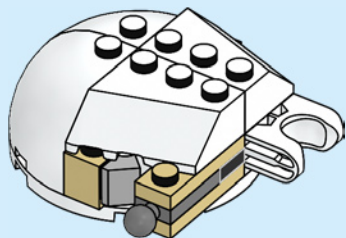

51

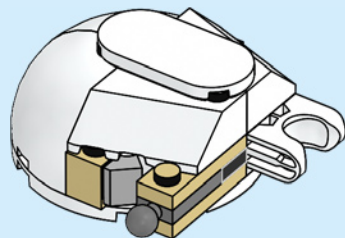



1x

52

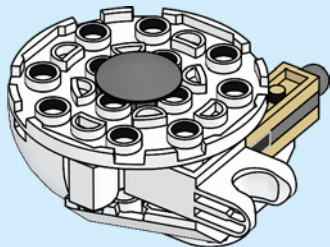

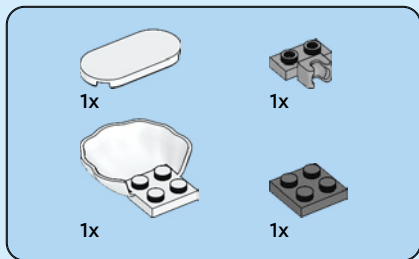

53

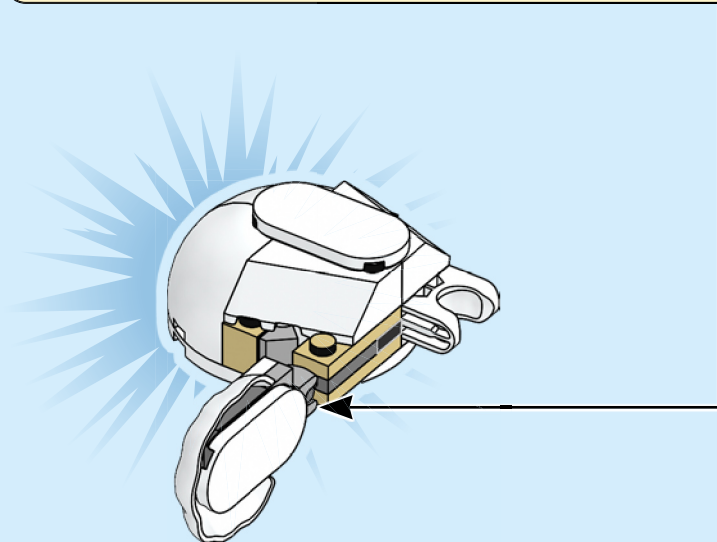
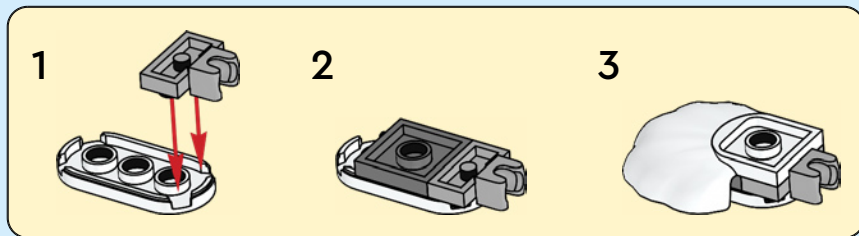

54

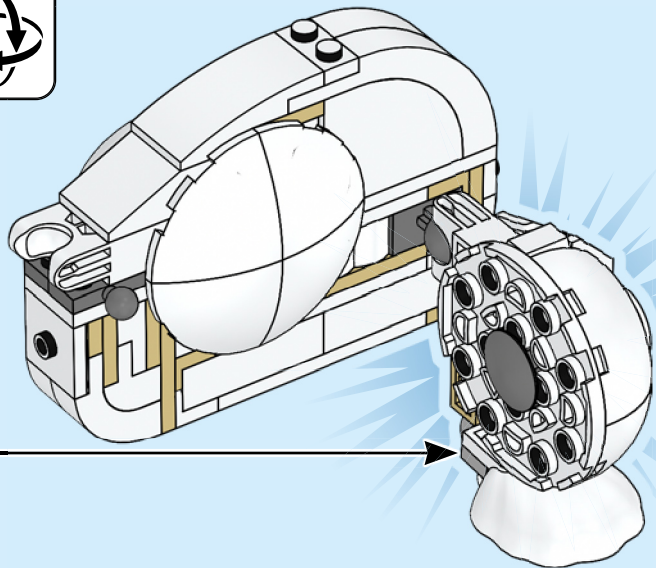

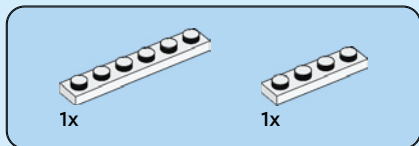
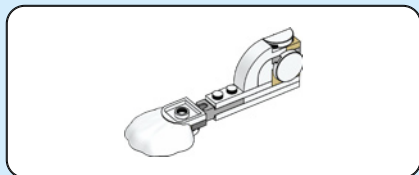

55

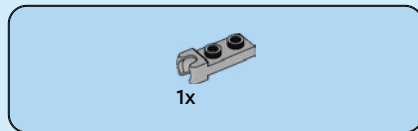
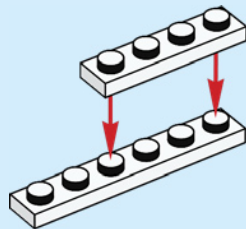

56

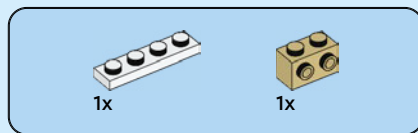
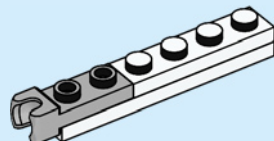

57

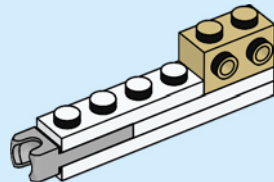



1x



1x

58

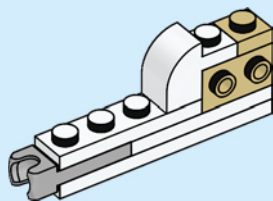

1x

59

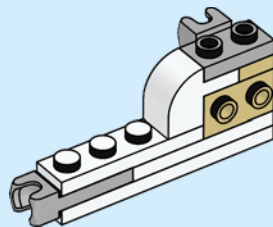

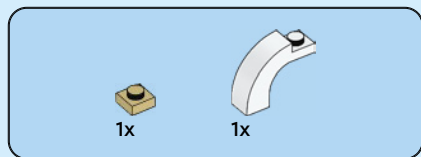

60

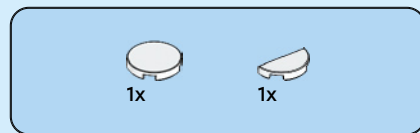
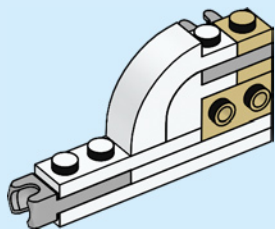

61

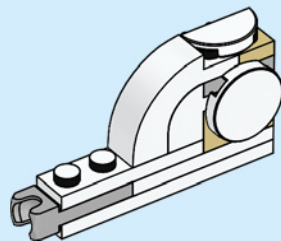

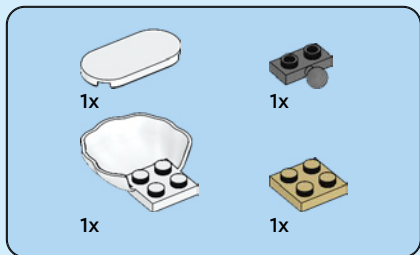

62

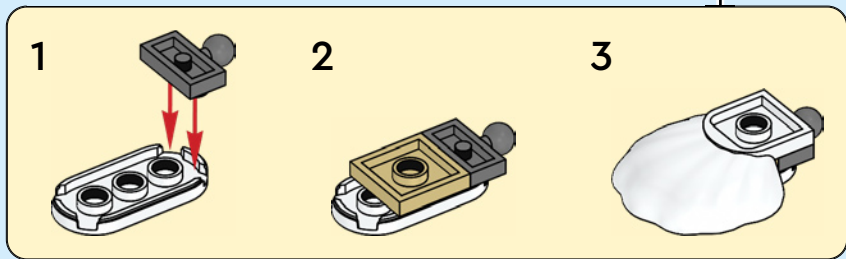
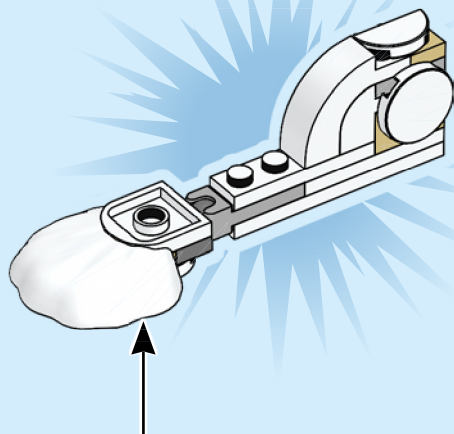



63

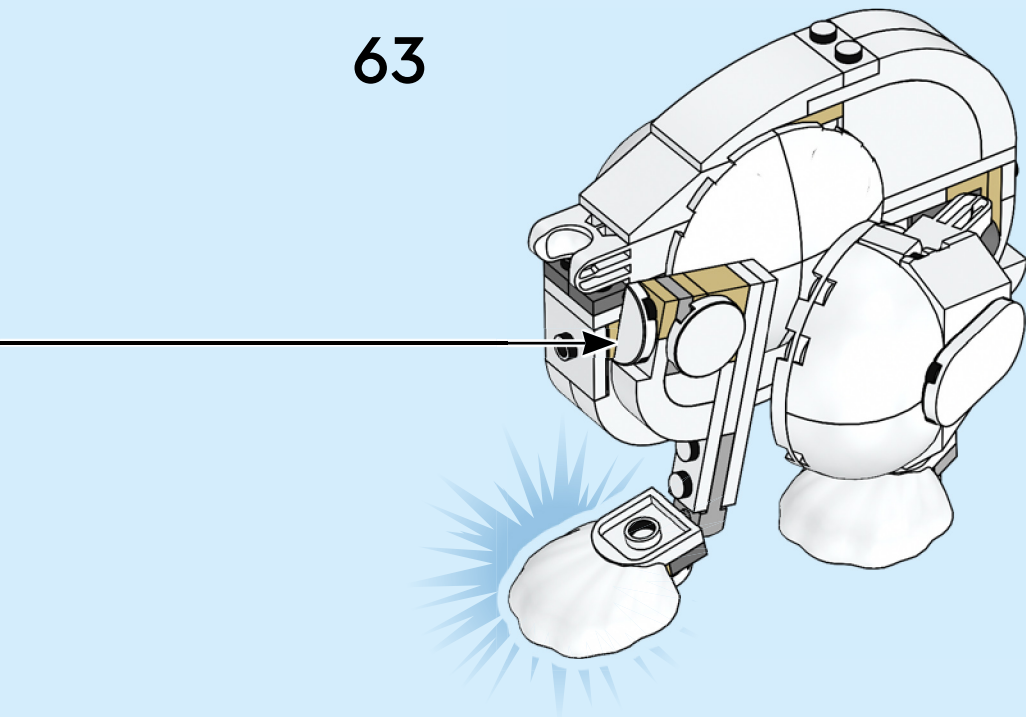

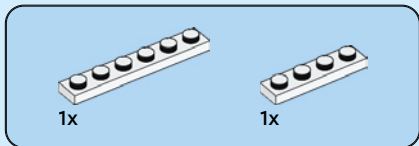
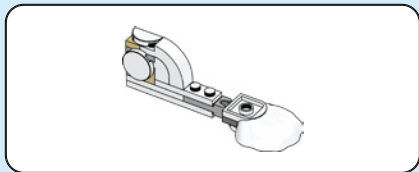

64

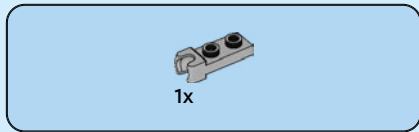
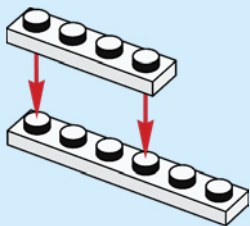

65

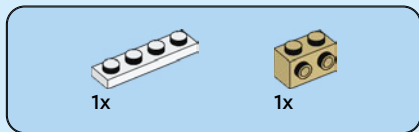
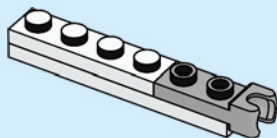

66

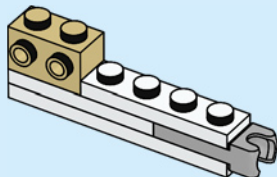



1x



1x

67

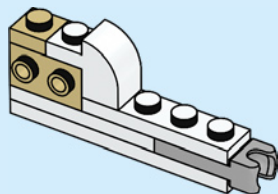

1x

68

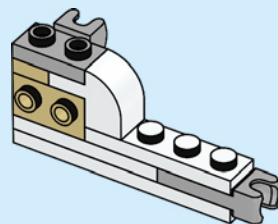

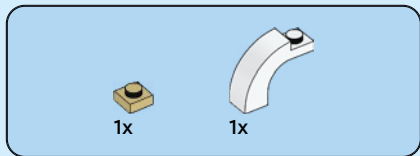

69

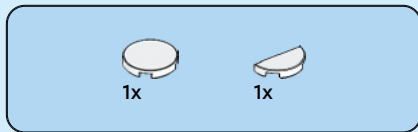
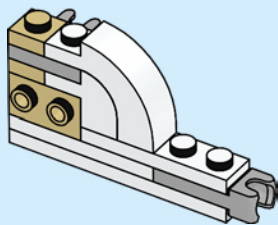

70

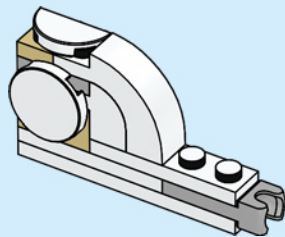

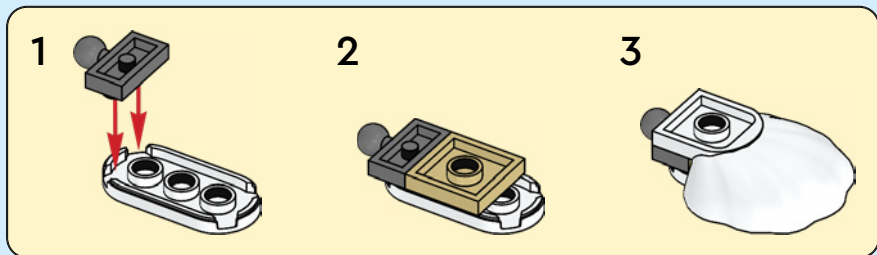
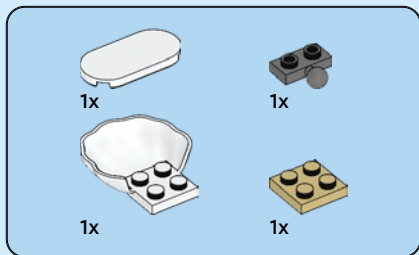

71

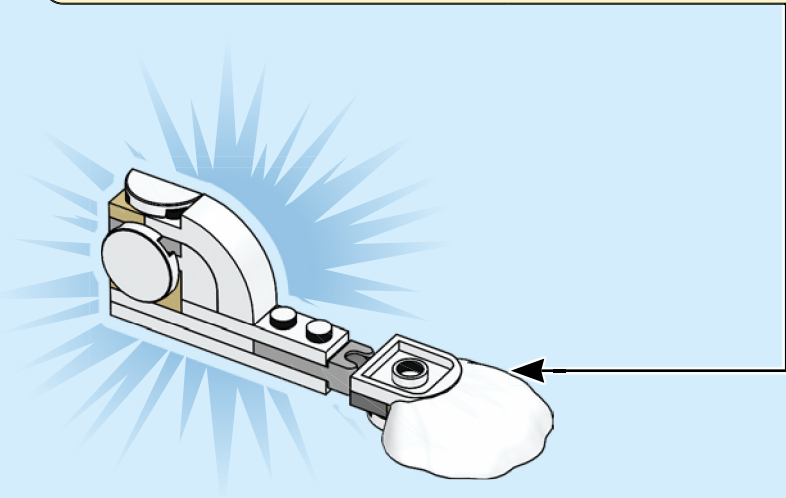



72

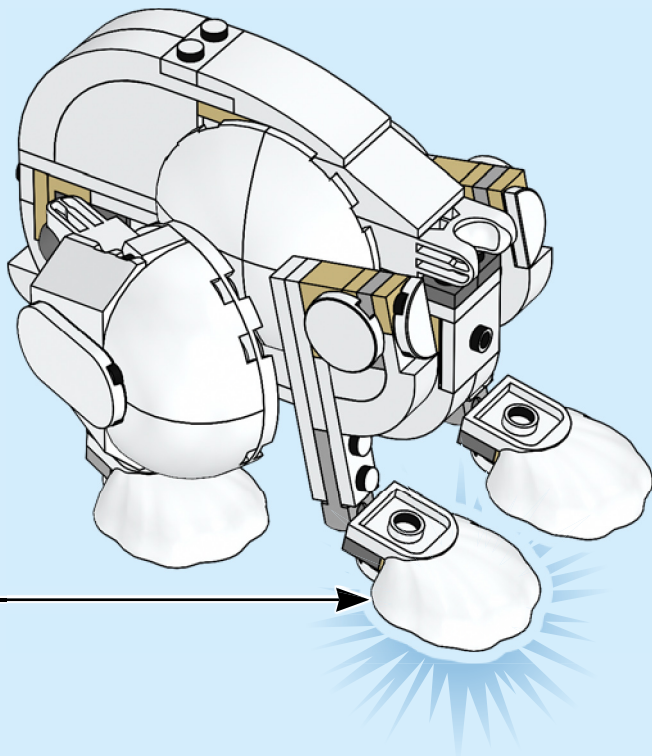

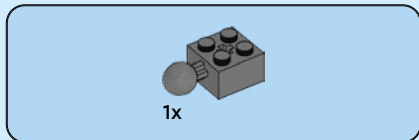
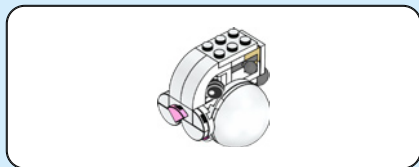

73

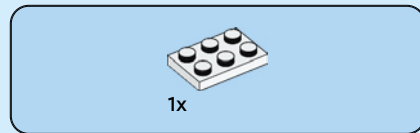
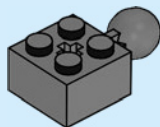

74

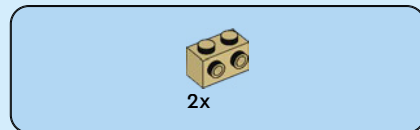
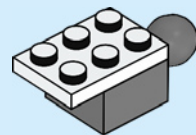

75

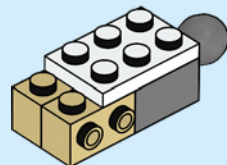



1x

76

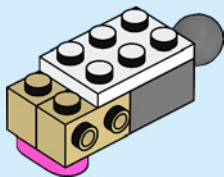

1x

77

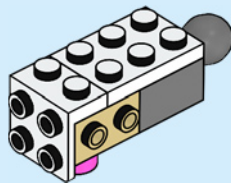

1x



1x



2x

78

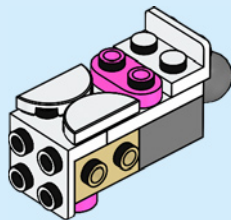





1x



1x



2x



2x



1x



1x



1x

# 79

## 1

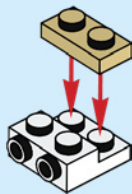

## 2

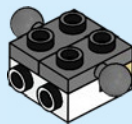

## 3

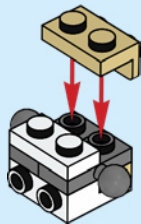

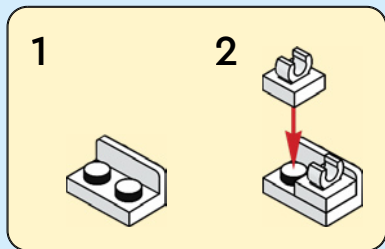

4

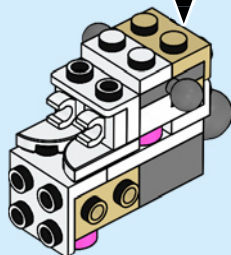
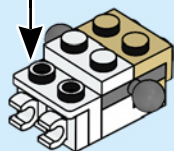

80

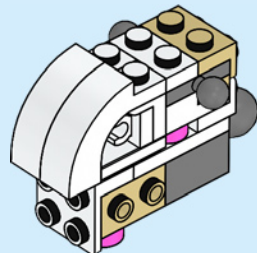

2x

2x

# 81

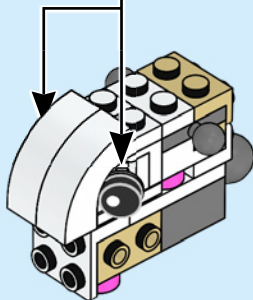
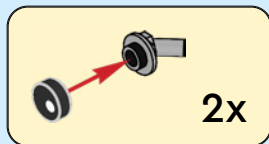

1x



1x

# 82

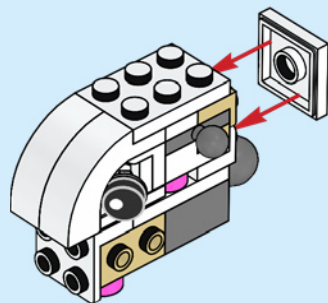



6

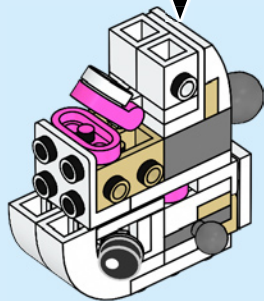
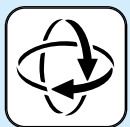
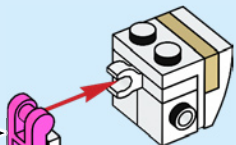
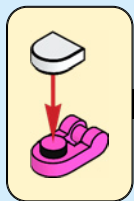

2x



2x



84

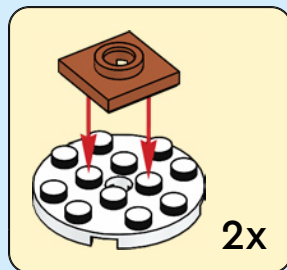

2x

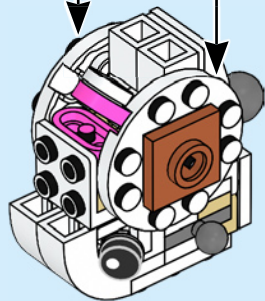

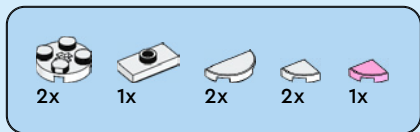

# 85

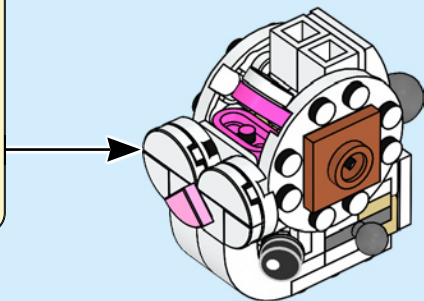
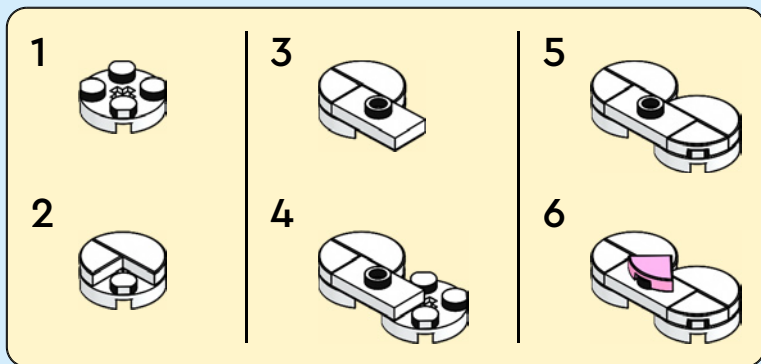



2x

86

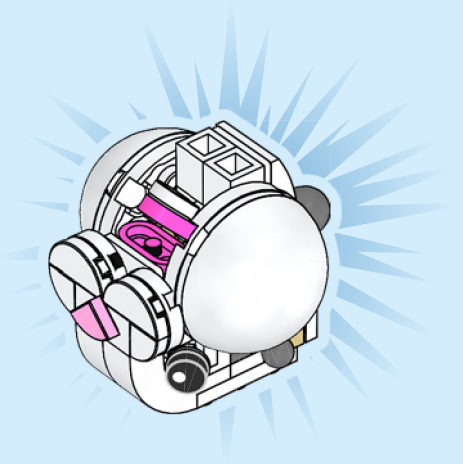

87

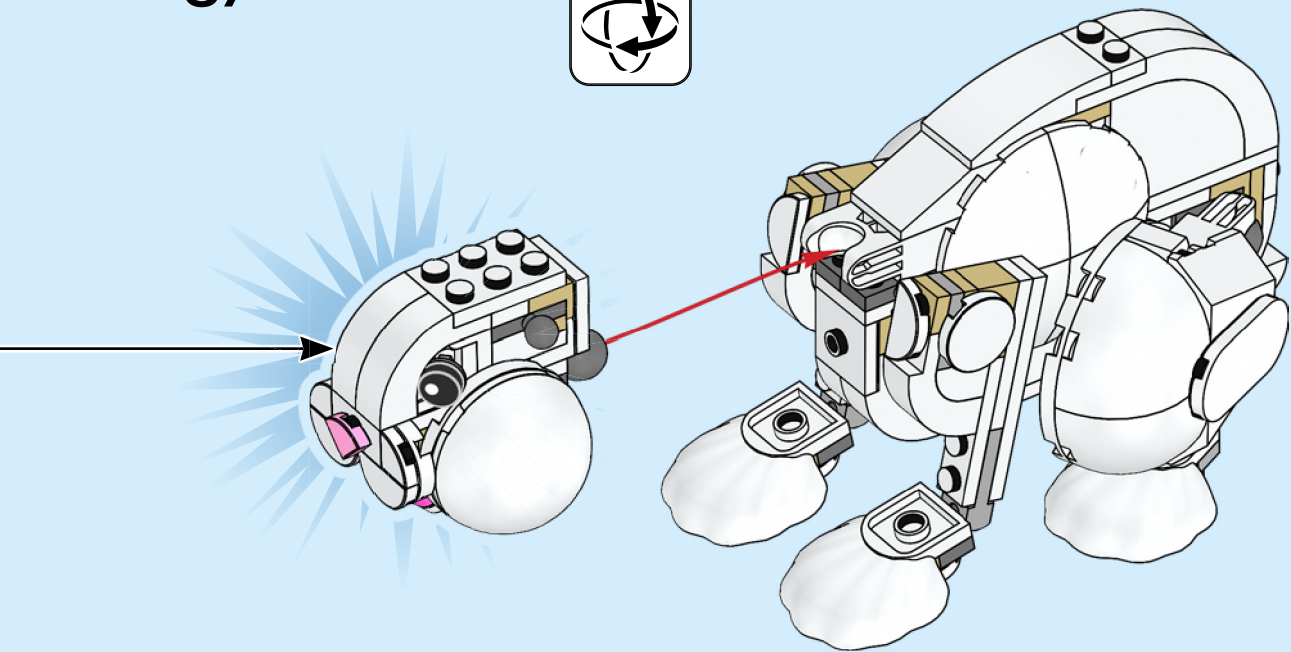





2x



4x



4x



2x



2x



2x



4x



2x

88

1

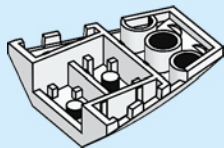

2

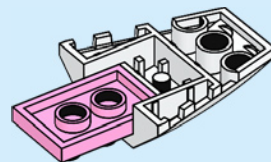

3

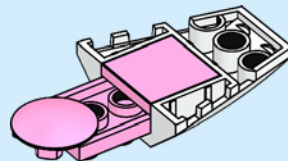

4

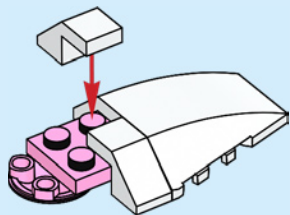

5

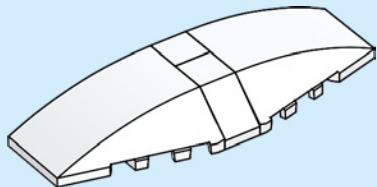

6

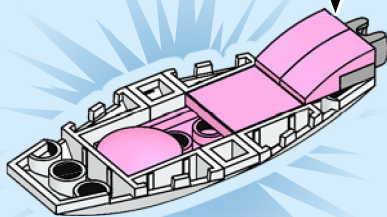
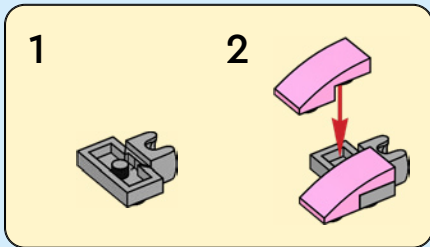

2x

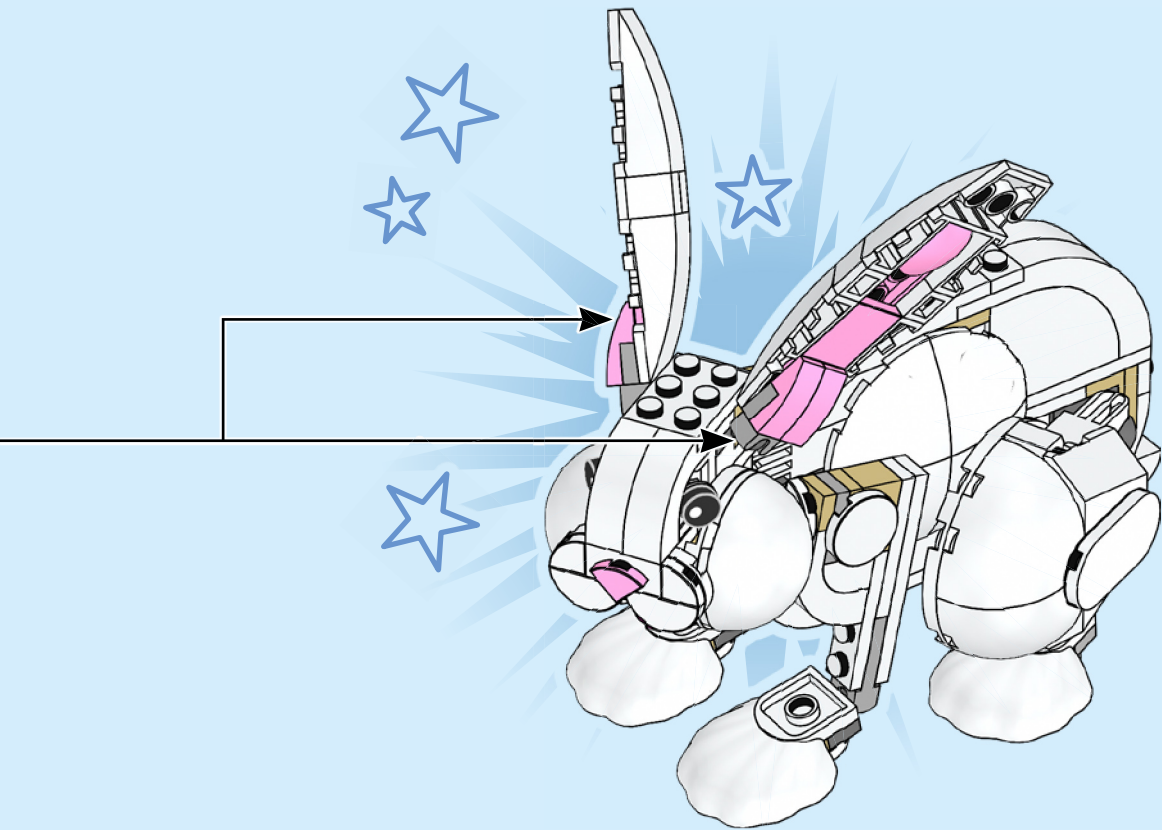

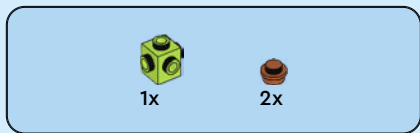

1



2

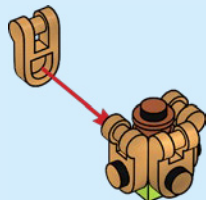

3

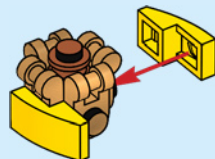

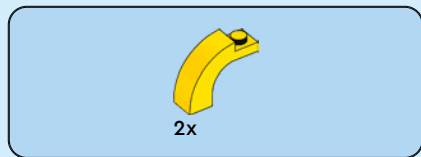

4

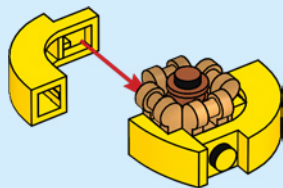

5

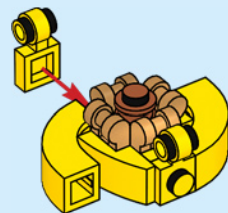



6

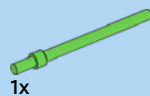
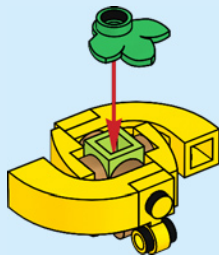

7

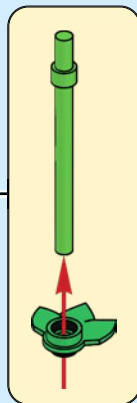
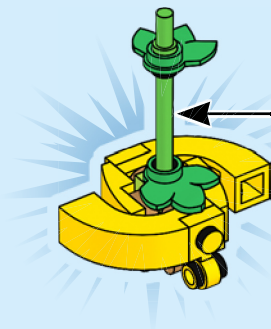

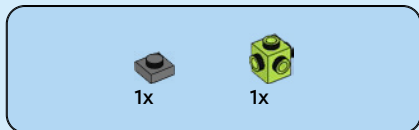
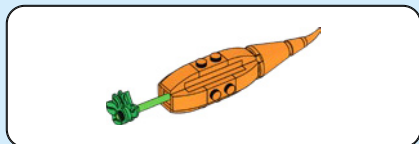

1

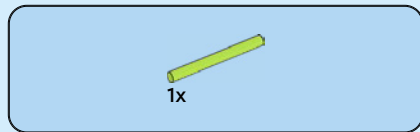

2

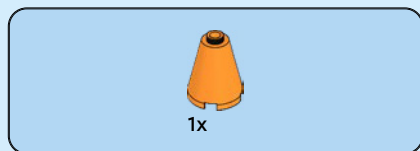

3





1x



1x

4



2x



1x

5





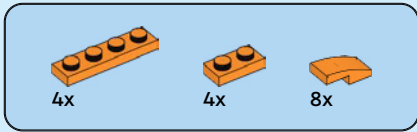

6

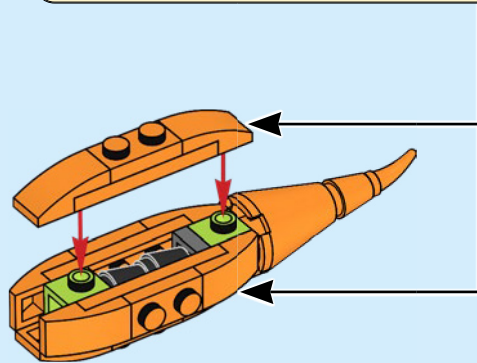
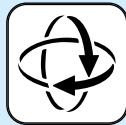
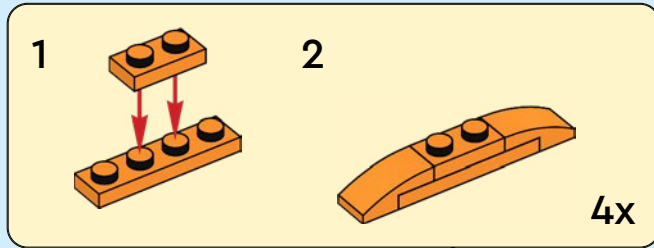

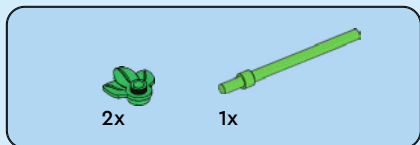

7

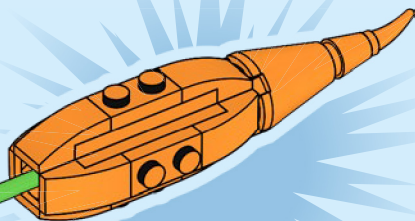

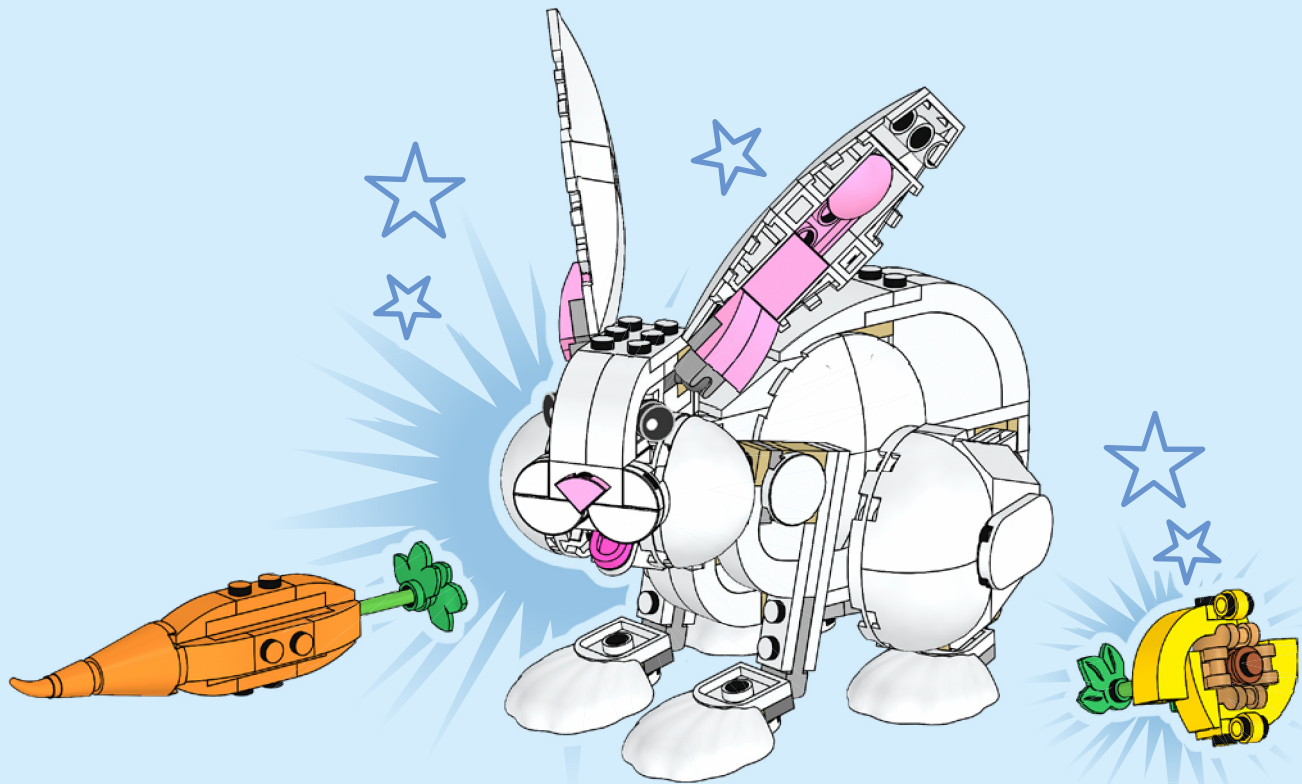

YOU COULD **WIN**



Scan this QR code or go to **LEGO.COM/PRODUCTFEEDBACK** and give us your short feedback about this LEGO® set for a chance to win a cool LEGO prize.

Terms and Conditions apply\*

**DE: Du könntest GEWINNEN.** Es gelten die Teilnahmebedingungen\* **FR: Tu pourrais GAGNER.** Des conditions s'appliquent\* **IT: Potresti VINCERE tu.** Termini e condizioni sono applicabili\* **ES: Puedes GANAR.** Aplican términos y condiciones\* **PT: Poderá GANHAR.** Aplicam-se termos e condições\* **JA: プレゼント付き! 利用規約が適用されます\*** **ZH: 轻松获奖. 条款和条件适用\*** **KO: 상품의 주인이 되어보세요. 소정의 약관이 적용됩니다\*** **RU: Вы можете ВЫИГРАТЬ.** Действуют положения и условия\* **PL: Szansa na WYGRANĄ.** Obowiązują warunki korzystania\* **CS: Máte šanci VYHRÁT.** Platí všeobecné smluvní podmínky\* **SK: Máte šancu VYHRAŤ.** Platia všeobecné zmluvné podmienky\* **HU: TE IS NYERHETSZ.** Felhasználási feltételek érvényesek\* **RO: Ai putea CÂȘTIGA.** Se aplică termeni și condiții\* **BG: Можете да СПЕЧЕЛИТЕ.** Има определени правила и условия\* **LV: Tu vari LAIMĒT.** Ir spēkā noteikumi un nosacījumi.\* **ET: Sul on võimalus VÕITA.** Kehtivad tingimused\* **LT: Jūs galite LAIMĖTI.** Taikomos sąlygos\*  
\*LEGO.com/productfeedback-terms