



Harry Potter



76399





Check for compatibility  
Kompatibilität prüfen  
Vérifier la compatibilité  
Controlla la compatibilità  
Comprueba tu compatibilidad  
Verificar a compatibilidade  
Ellenőrizd a kompatibilitást  
Pārbaudīt saderību  
检查兼容性

[LEGO.com/devicecheck](https://LEGO.com/devicecheck)



LEGO® Building Instructions



Download on the  
App Store



GET IT ON  
Google Play



腾讯应用宝  
安卓应用商店

Apple and the Apple logo are trademarks of Apple Inc.  
Google Play and the Google Play logo are trademarks of Google LLC.  
Tencent and the Tencent logo are trademarks of Tencent Inc.



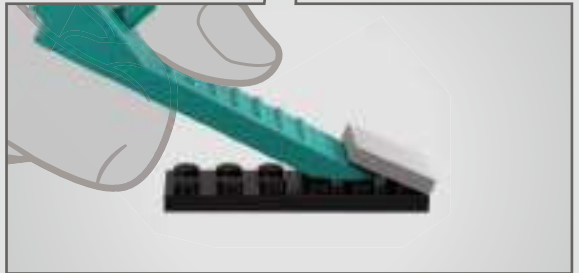
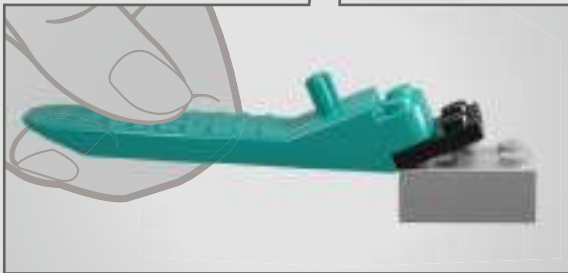
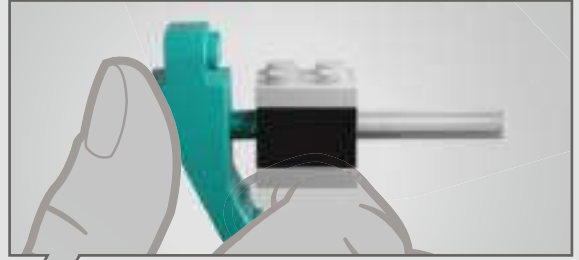





1



2



3





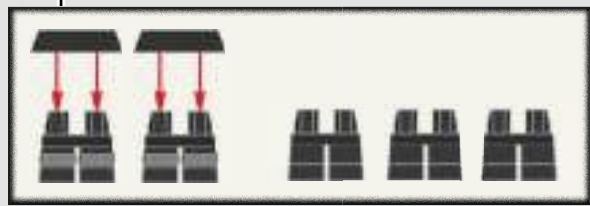
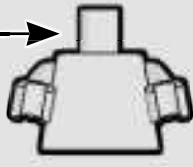
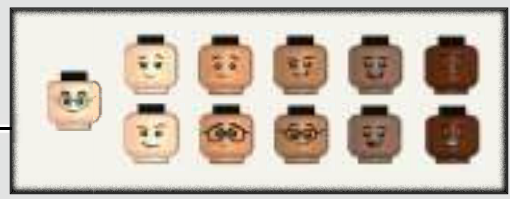



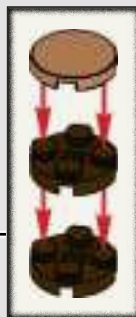
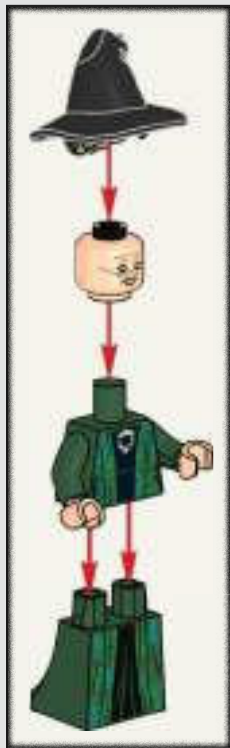



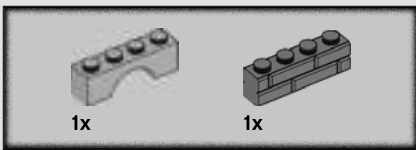

5

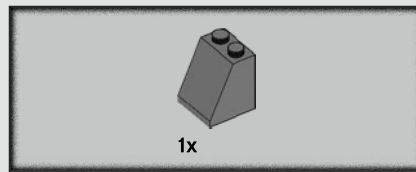
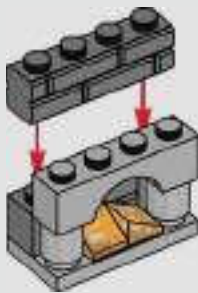

6

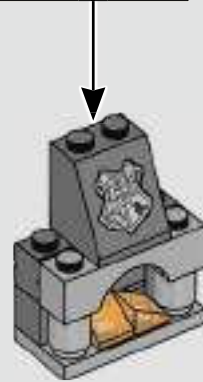
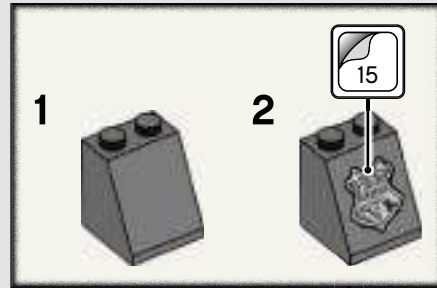

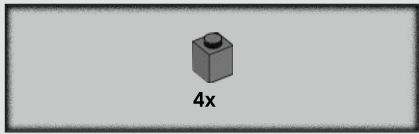

7

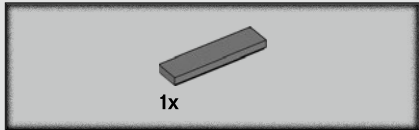
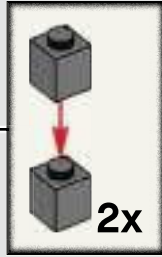

8

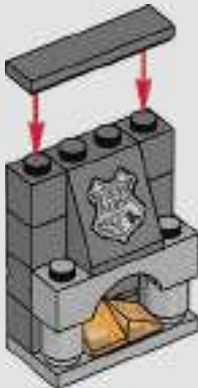

9





1



2

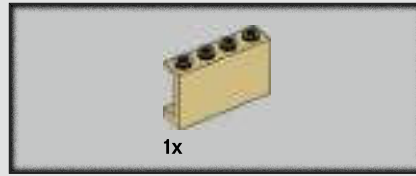

3

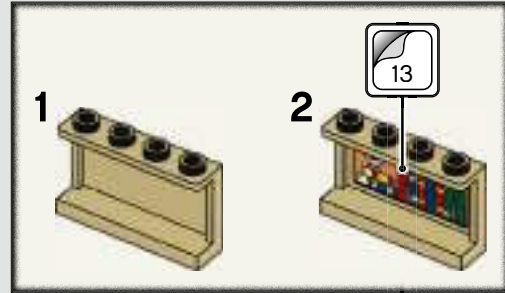



4

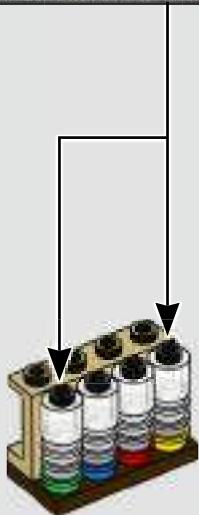
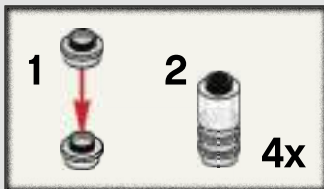

5

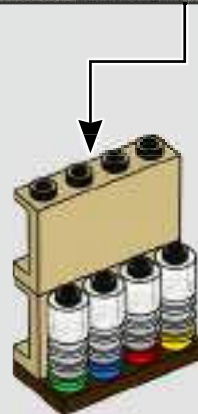
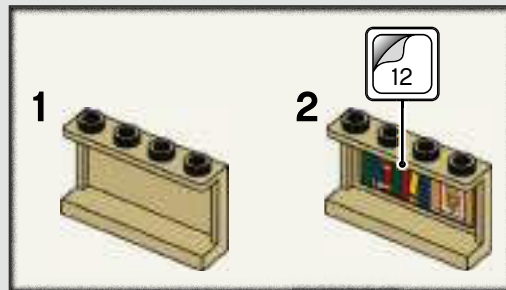



6

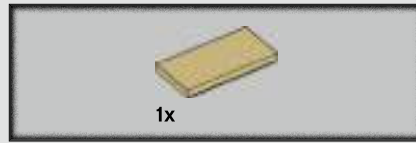
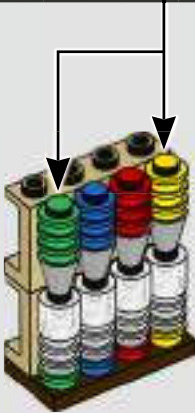
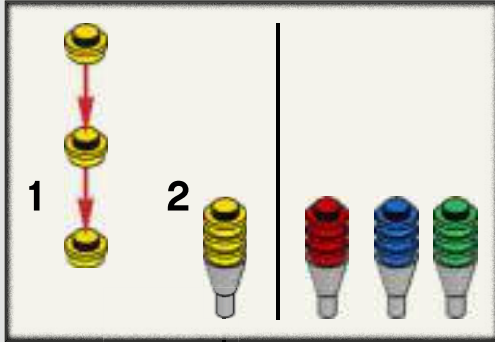

7





1

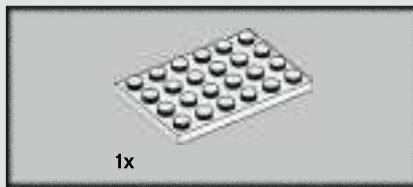

2



3





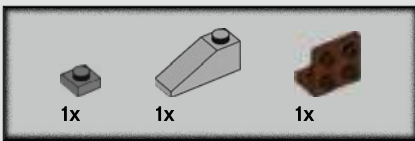

4

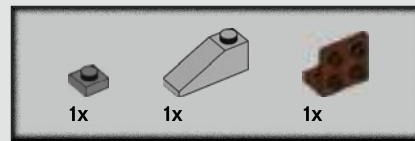
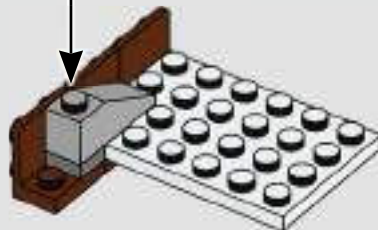
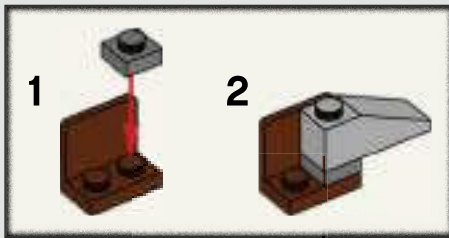

5

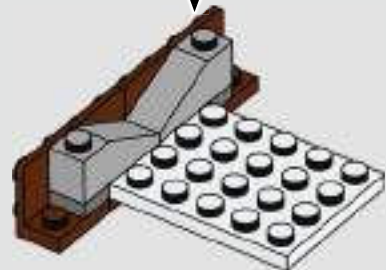
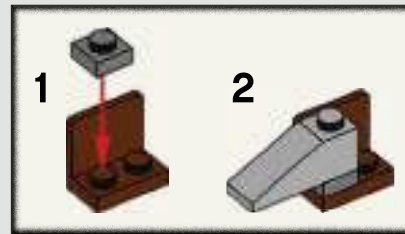

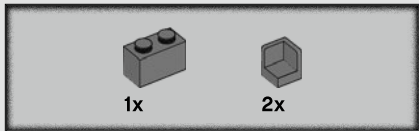

6

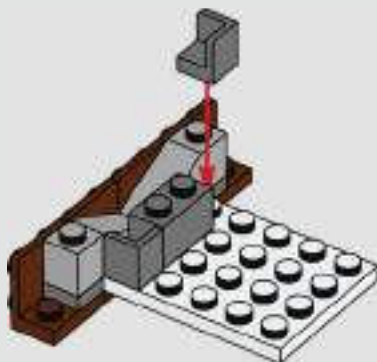

7

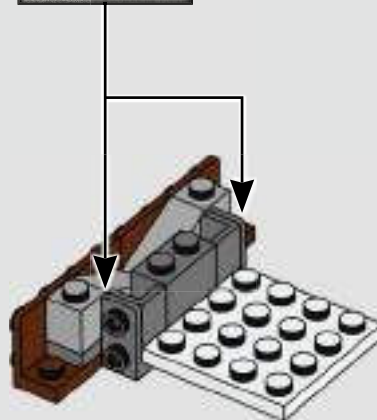

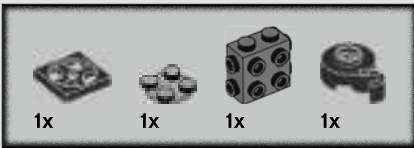

8

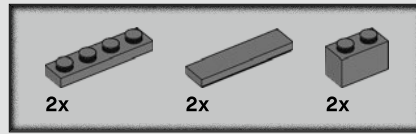
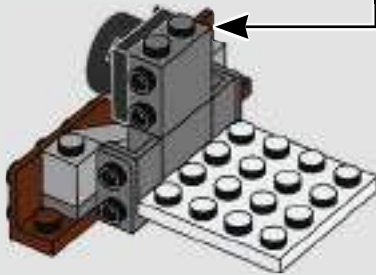
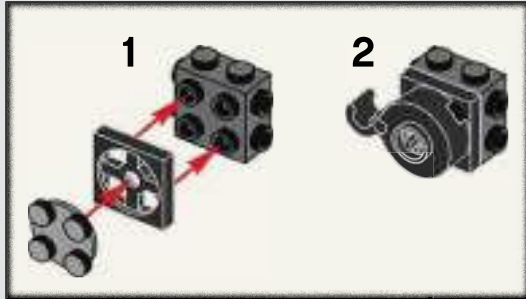

9

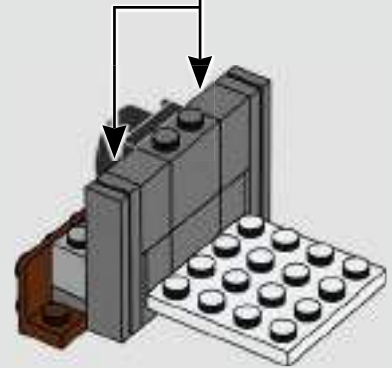
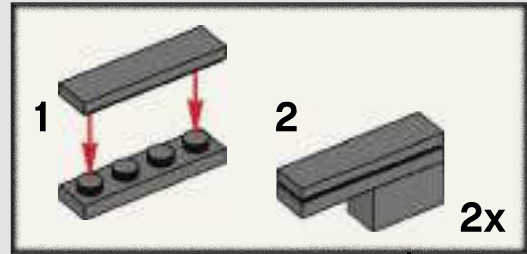

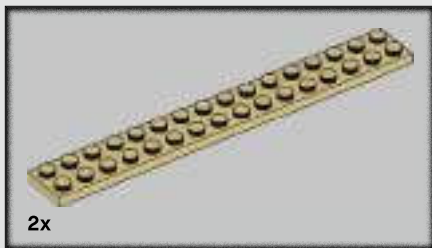

10

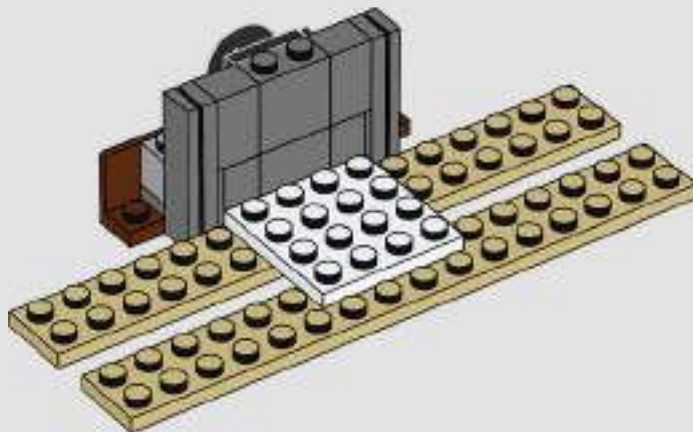

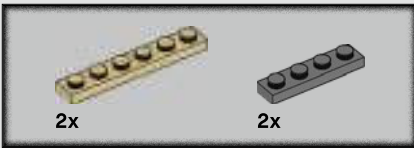

11

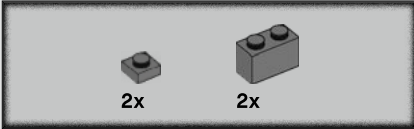
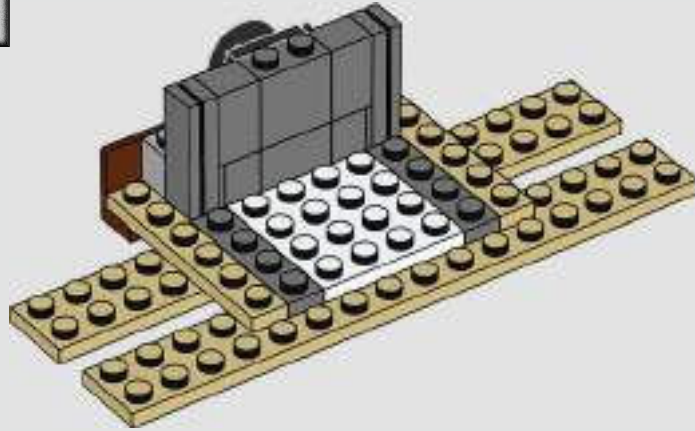

12

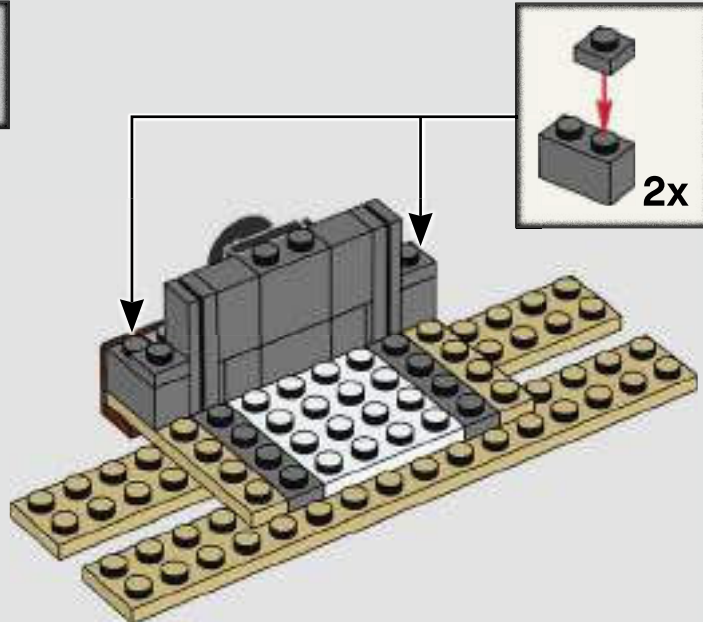

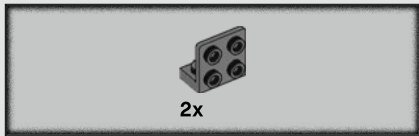

13

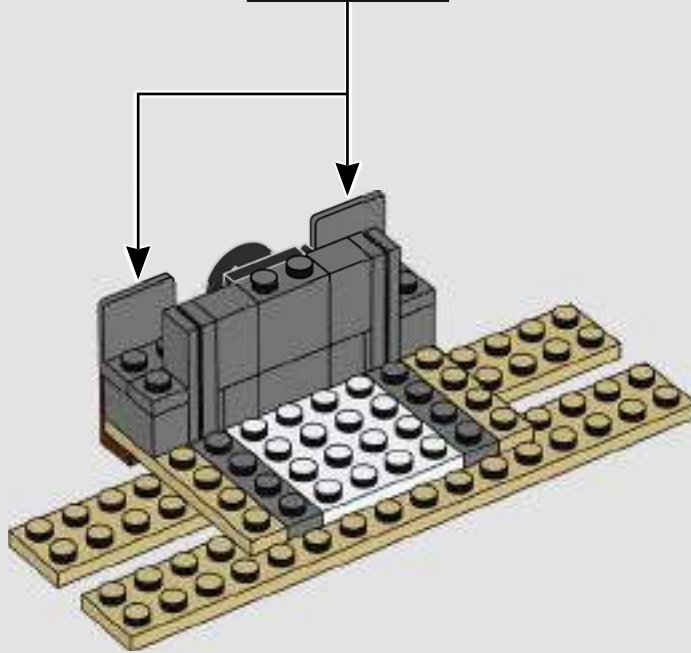
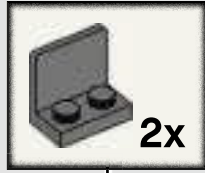



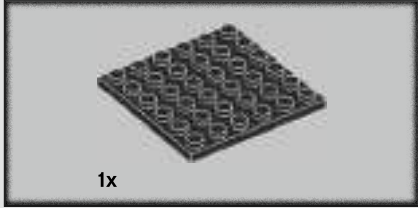

16

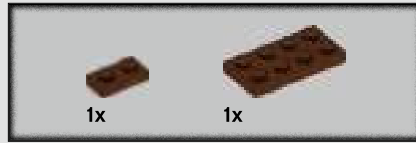
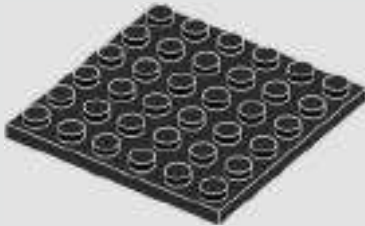

17

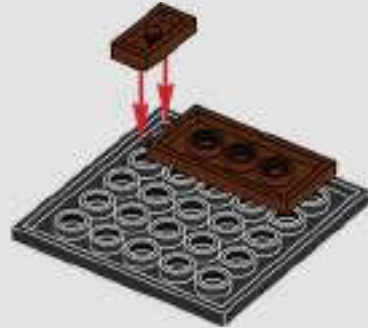
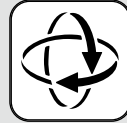





18

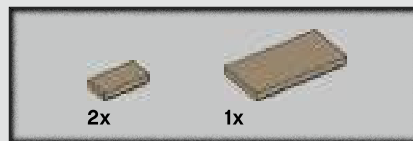
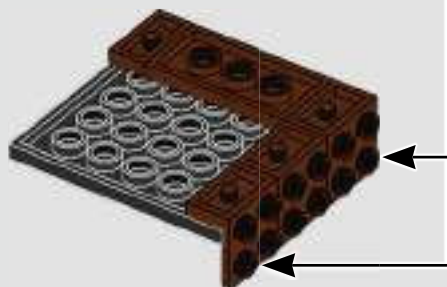

19

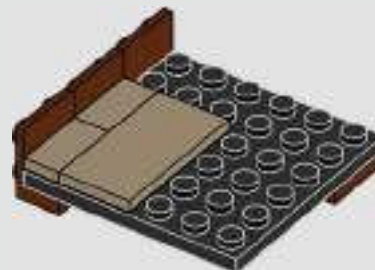

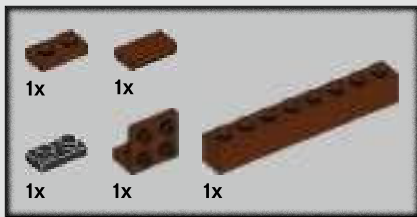

20

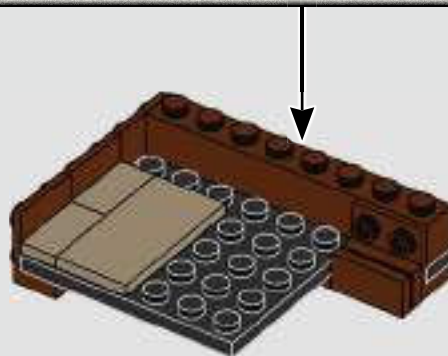
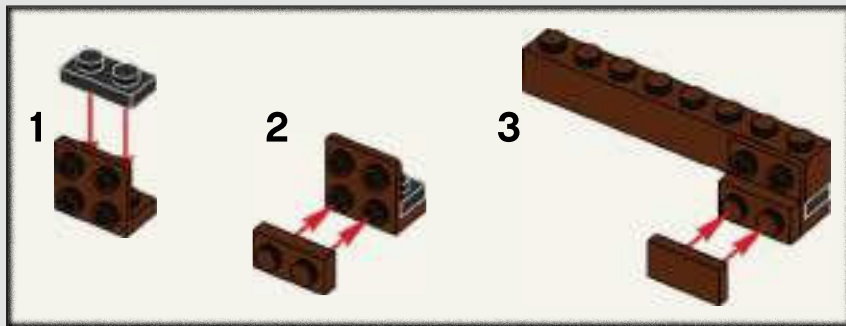

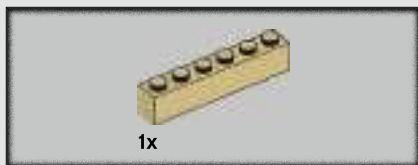

21

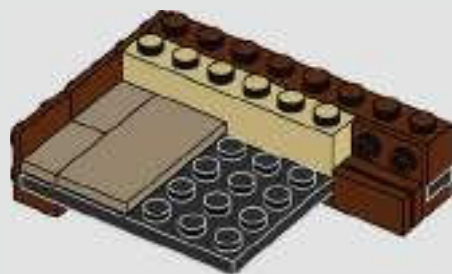

22

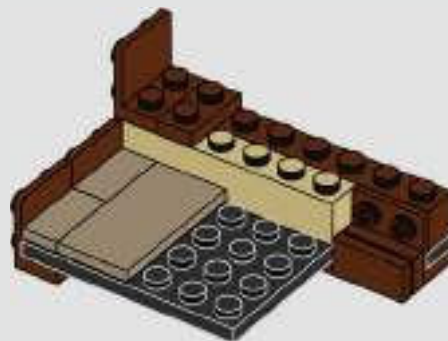



23

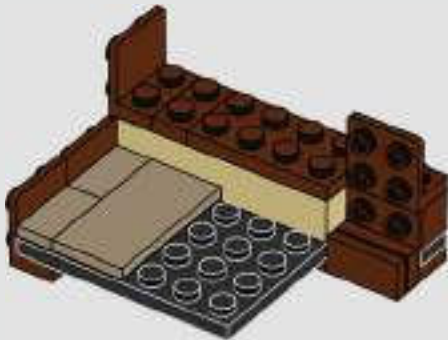

24

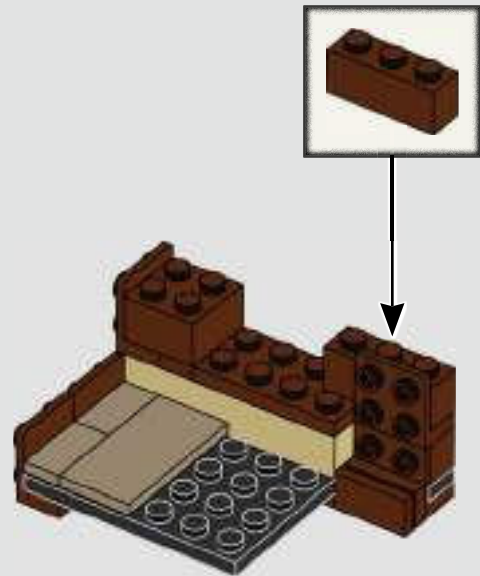

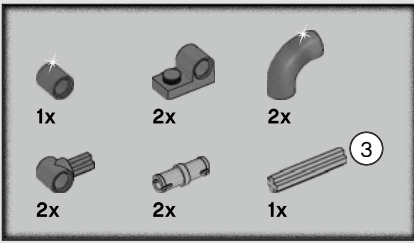

25



2



3



4

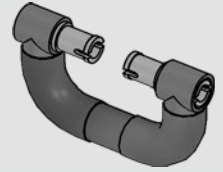

5

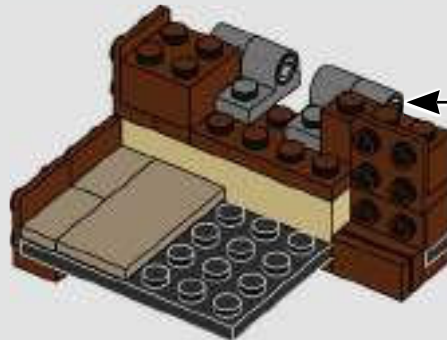
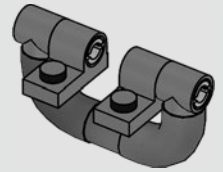

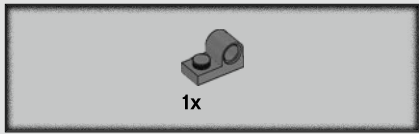

26

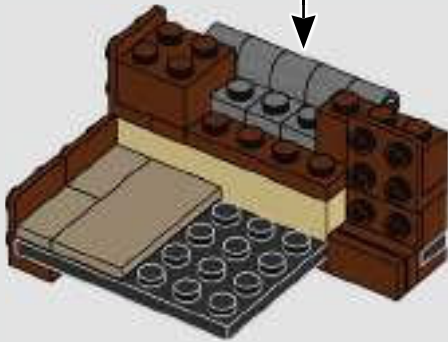

27

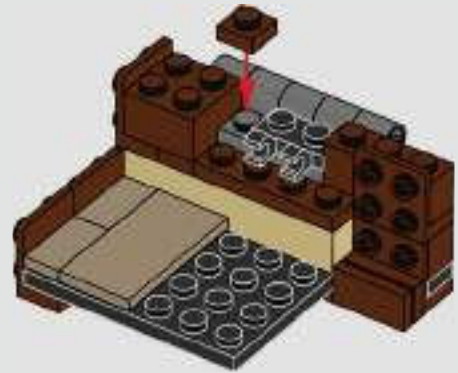

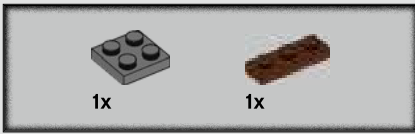

28

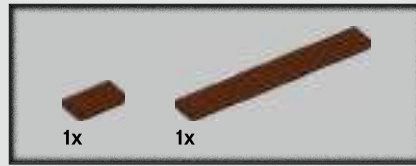
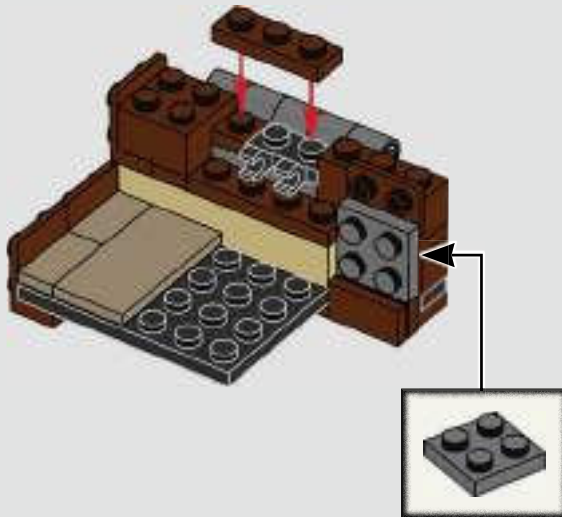

29



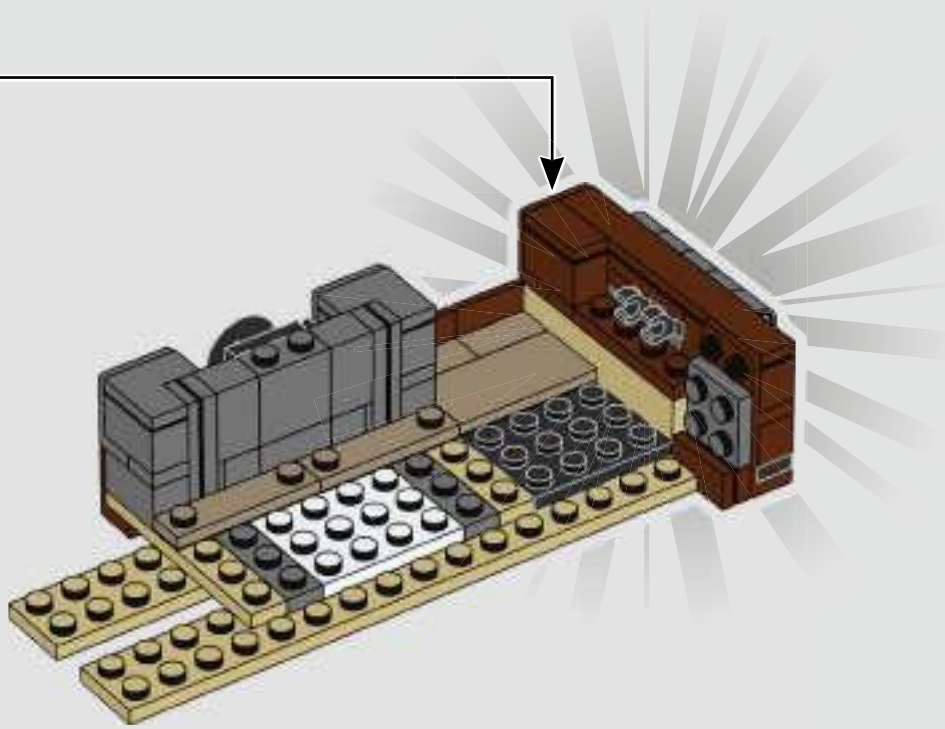



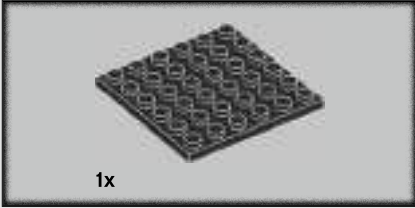

31

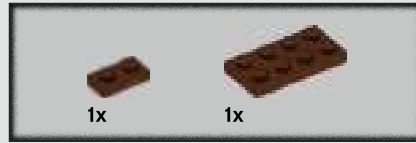
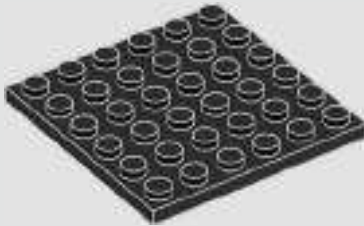

32

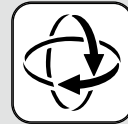



33

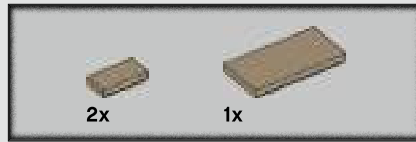

34

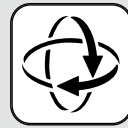

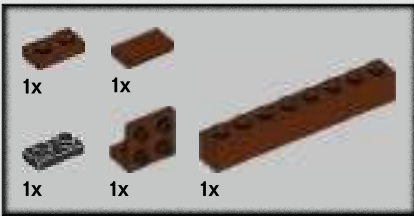

**35**

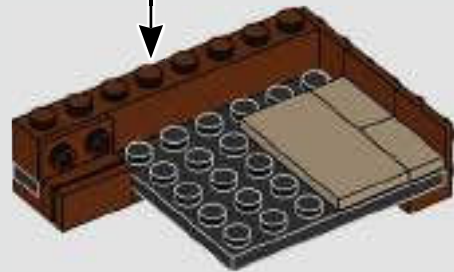
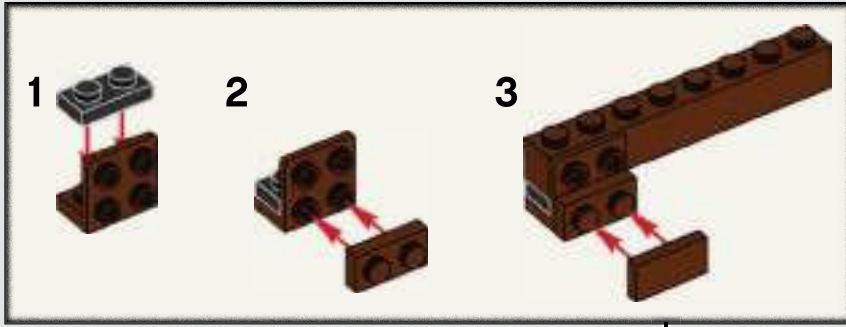

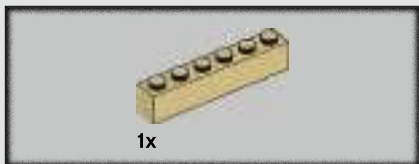

36

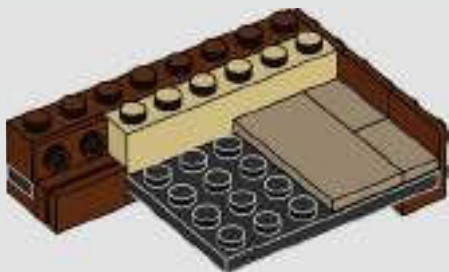

37

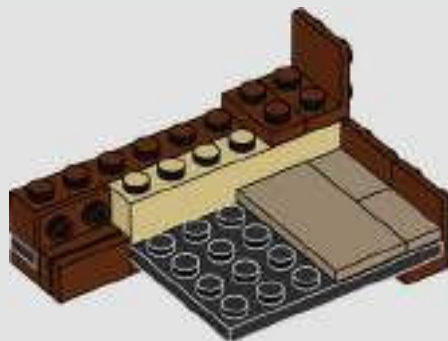



38

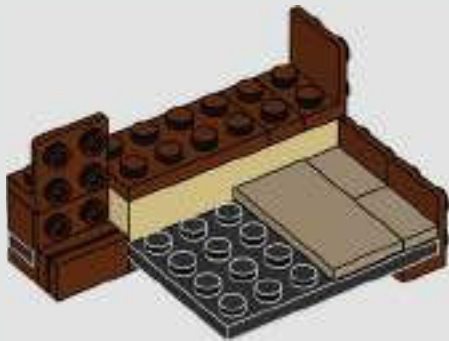

39

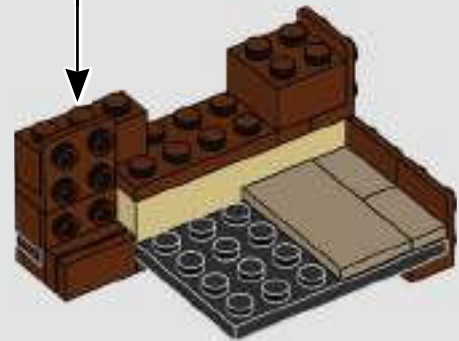
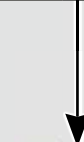

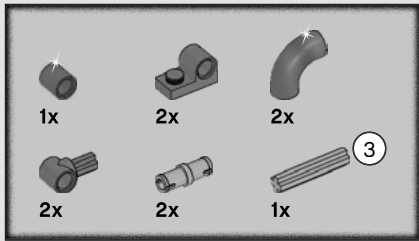

40

1

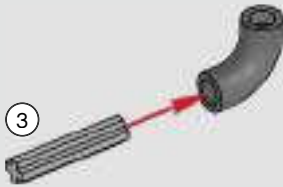

2

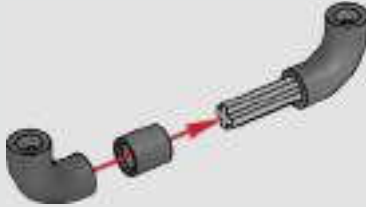

3



4

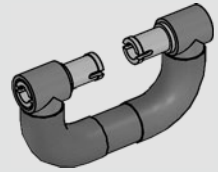

5

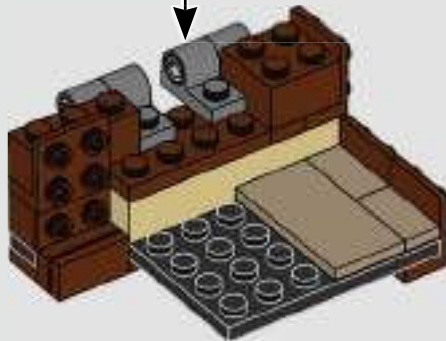
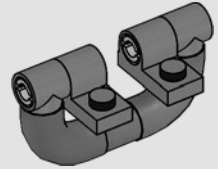

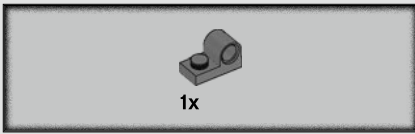

41

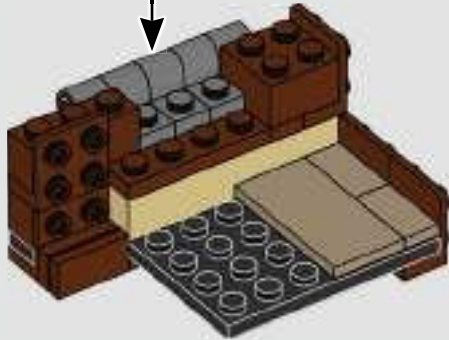

42

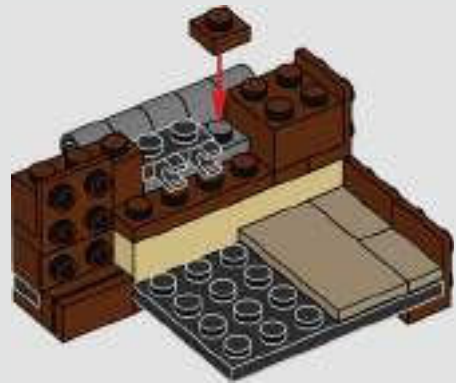



43

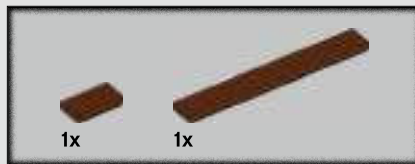
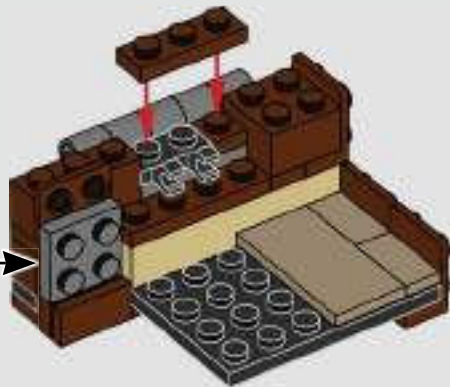

44

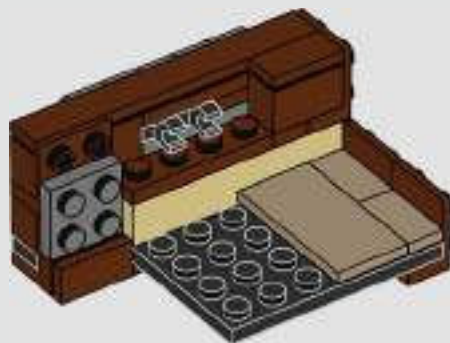



45

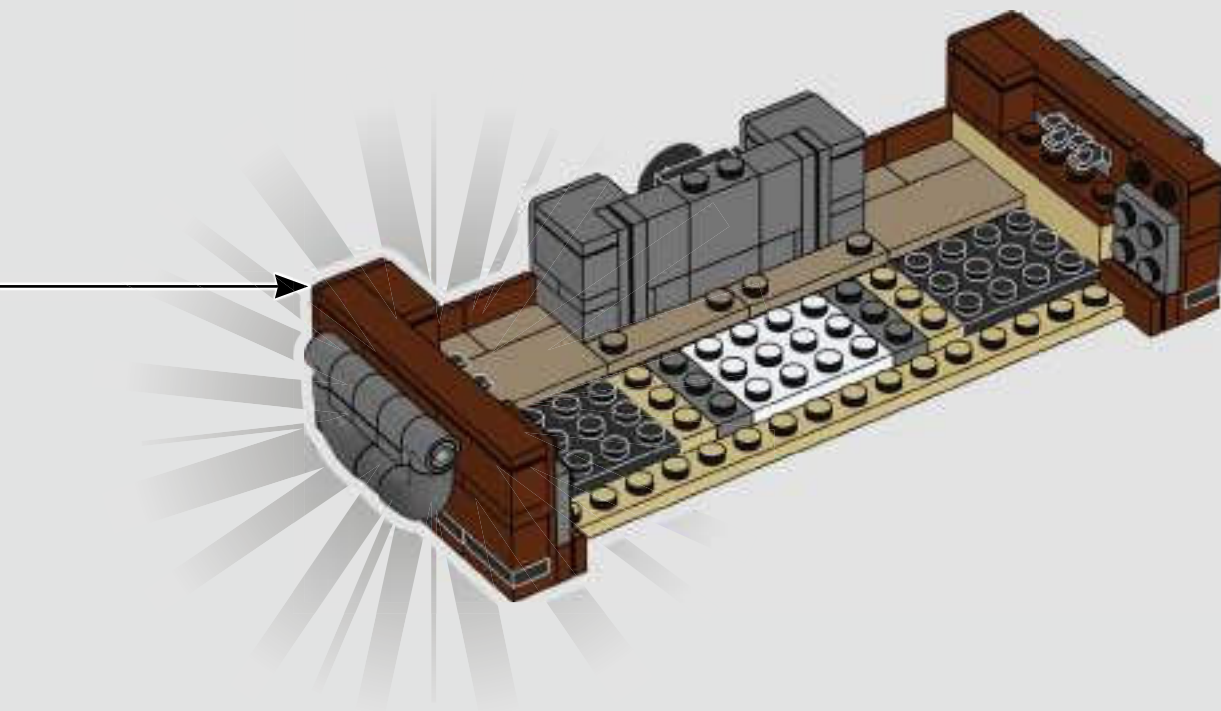



46

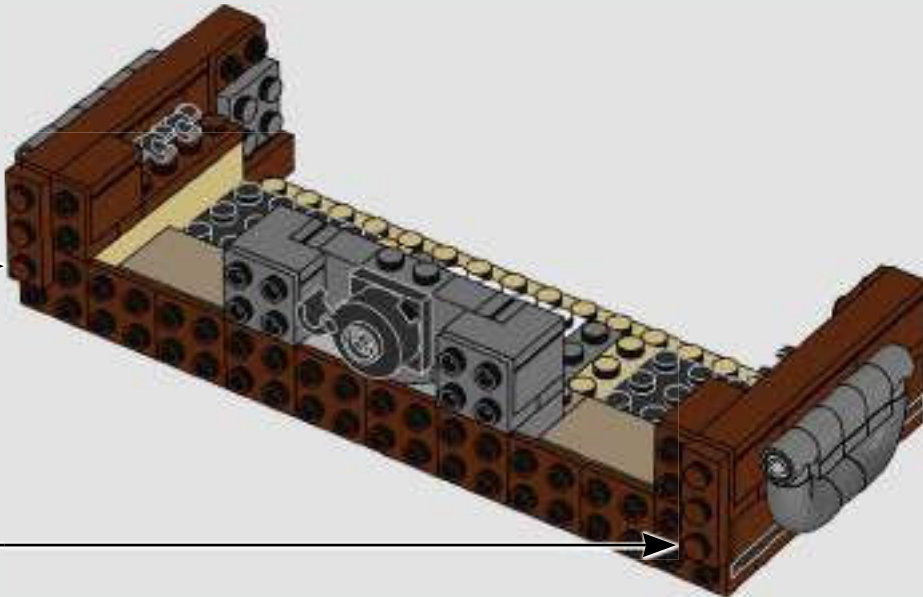

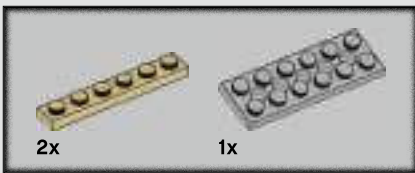

47

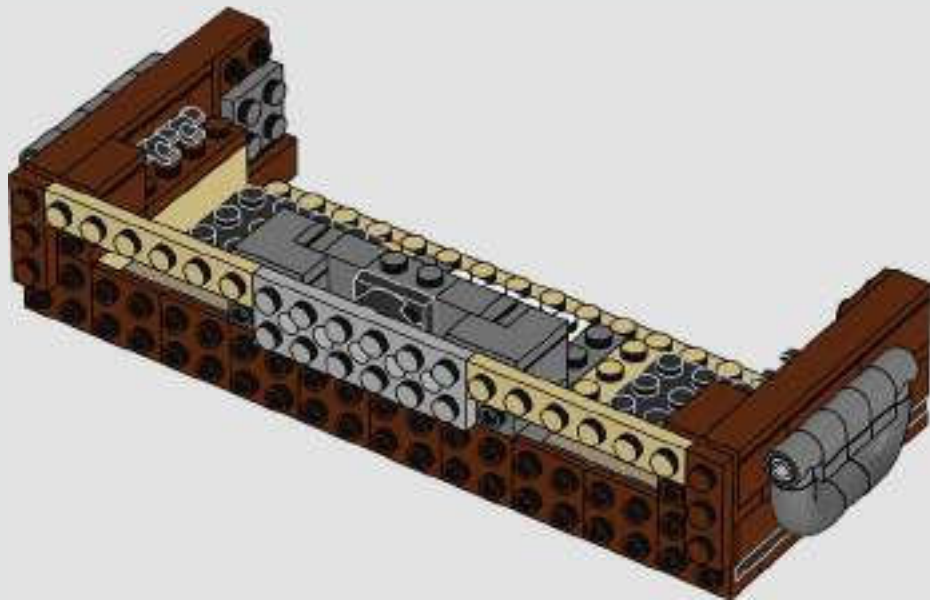

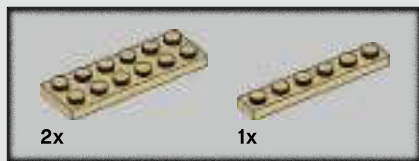

48

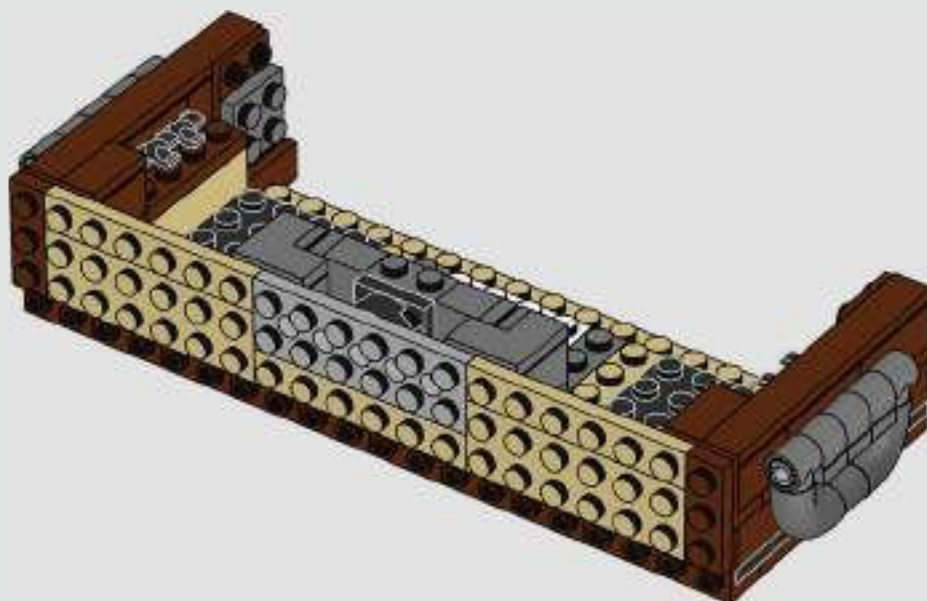

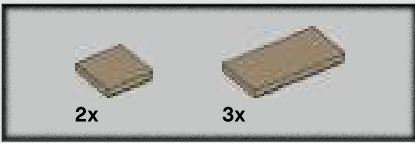

49

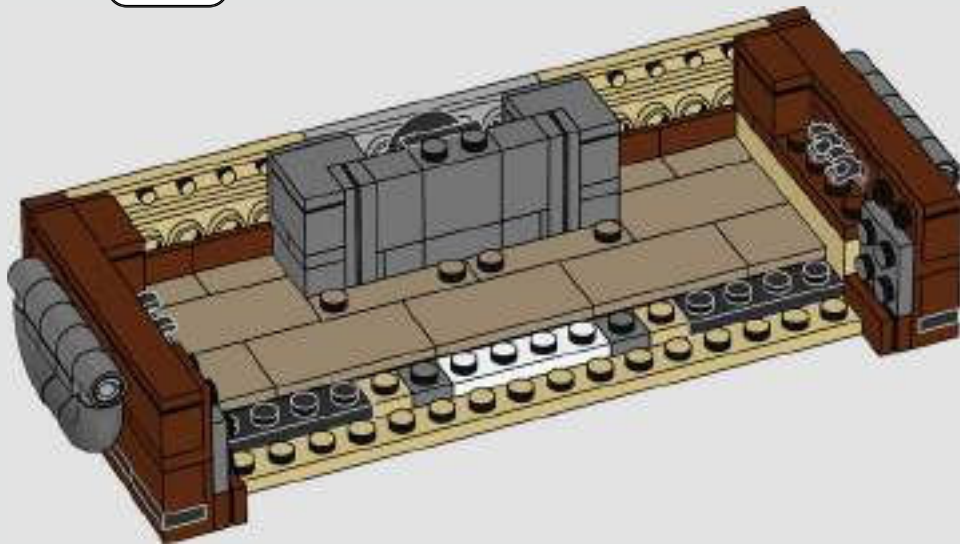

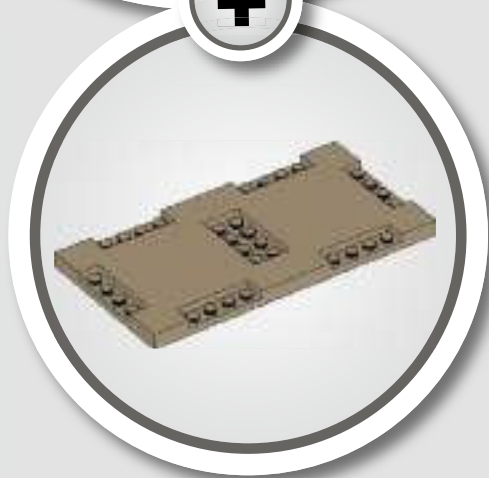

50

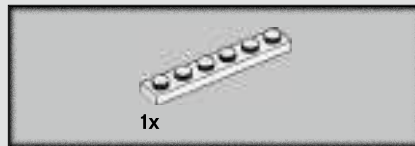

51

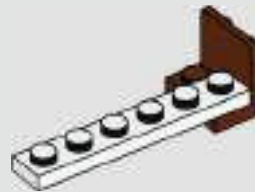



52

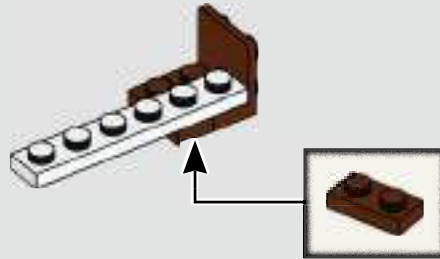

53

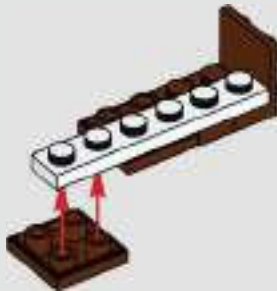

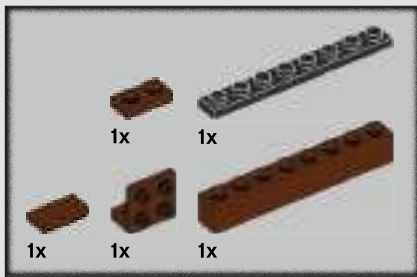

54

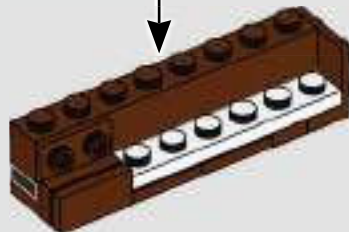
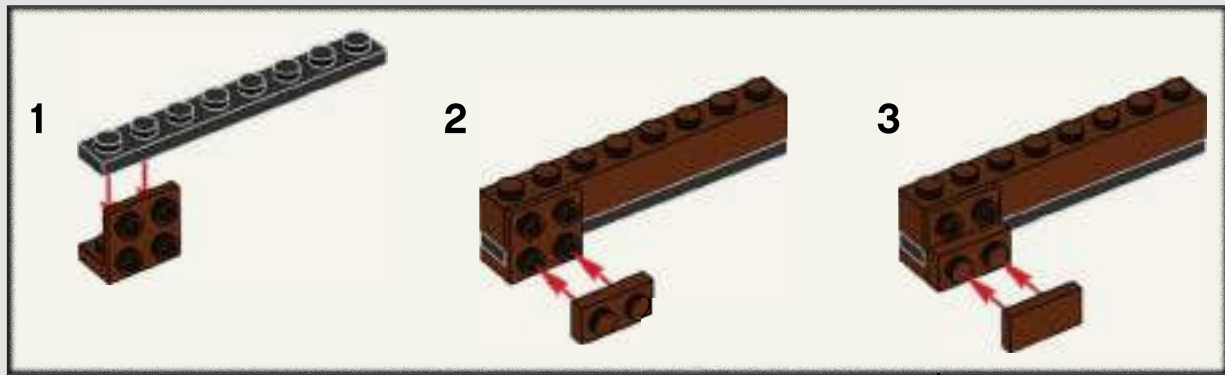





55

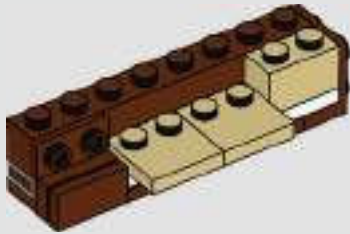

56

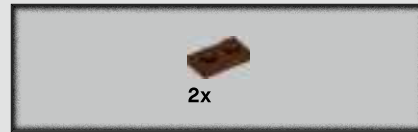
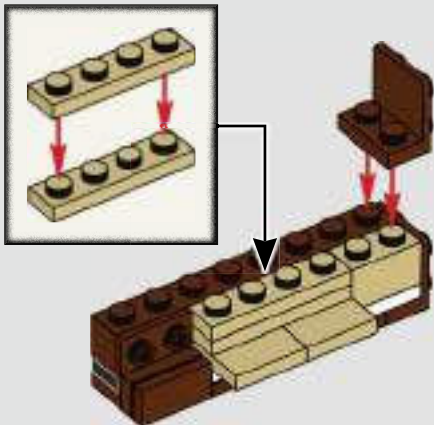

57

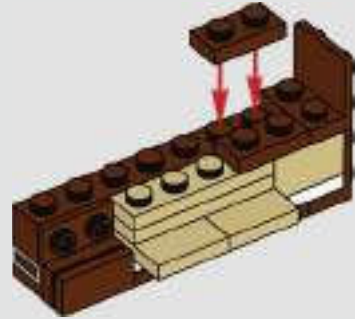

58

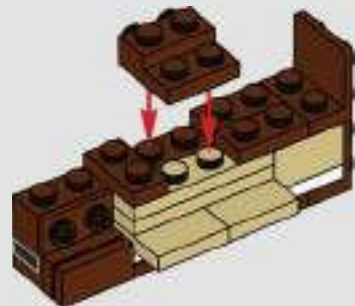



59

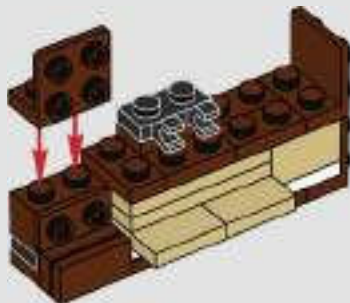

60

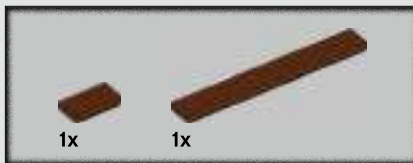
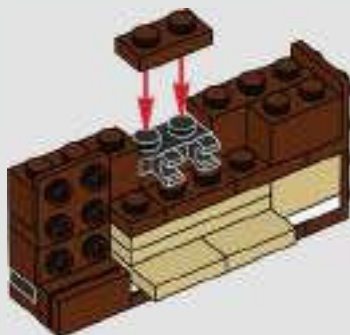

61

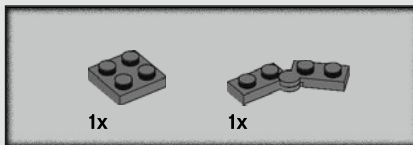
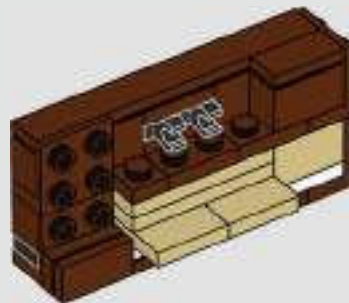

62

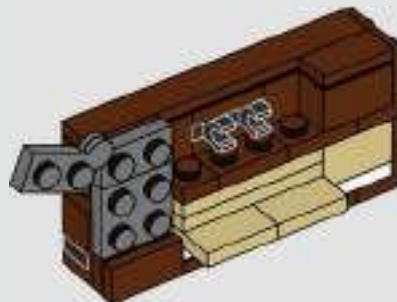

63

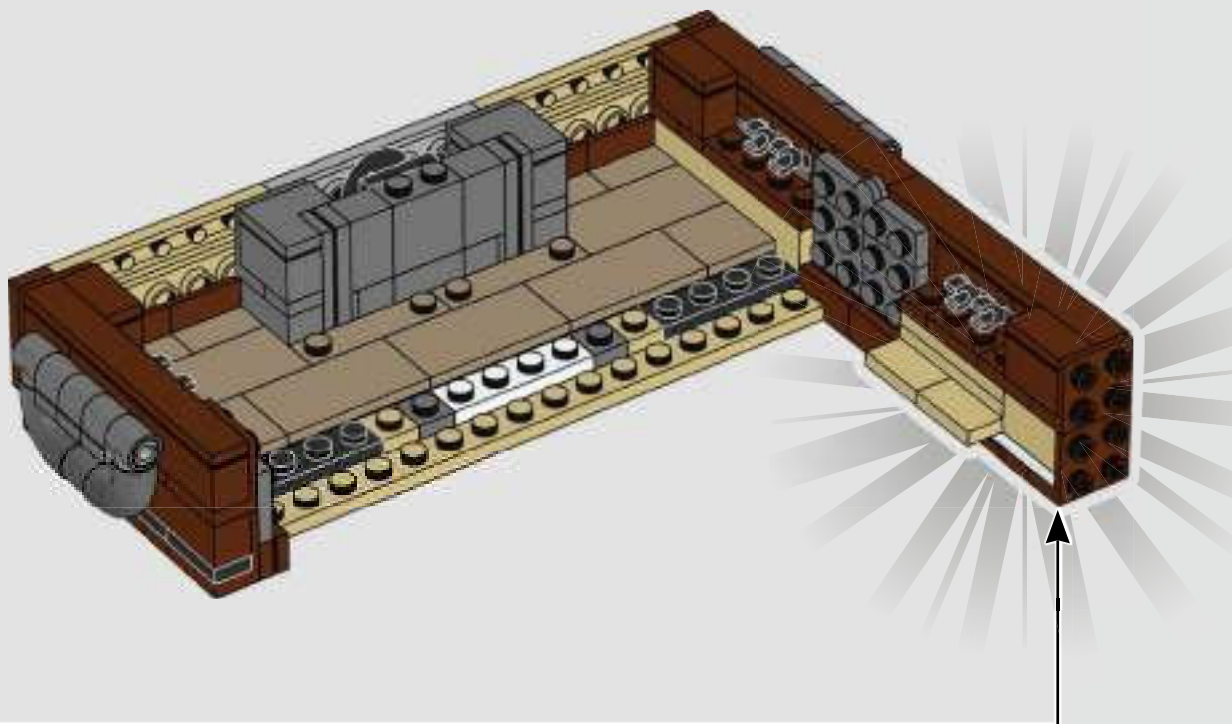



64

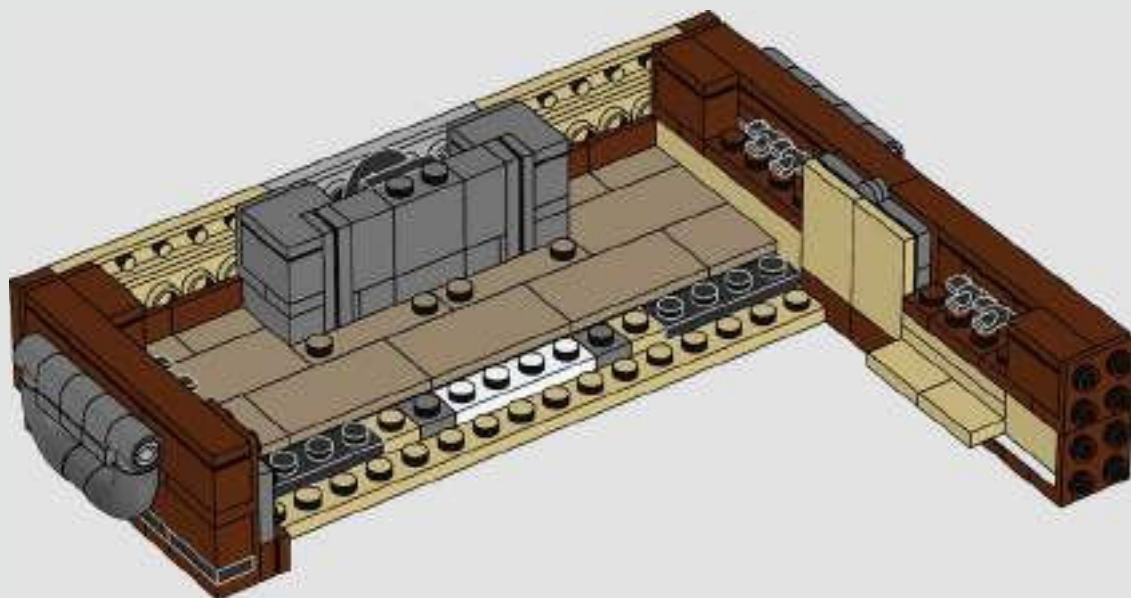



65

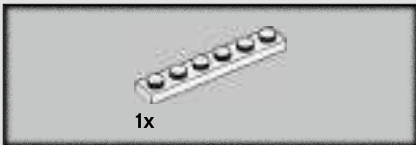

66

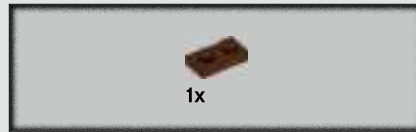
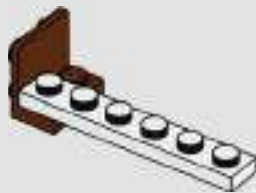

67

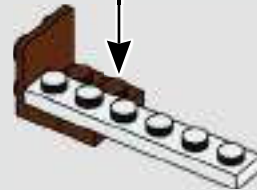

68

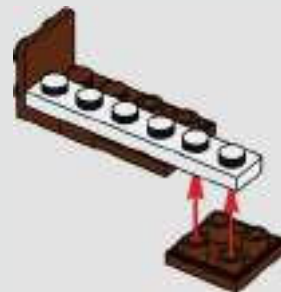

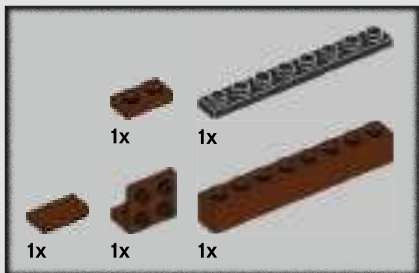

69

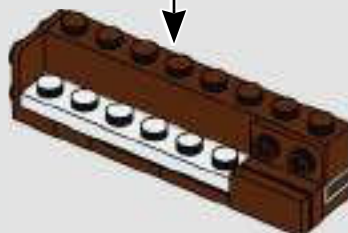
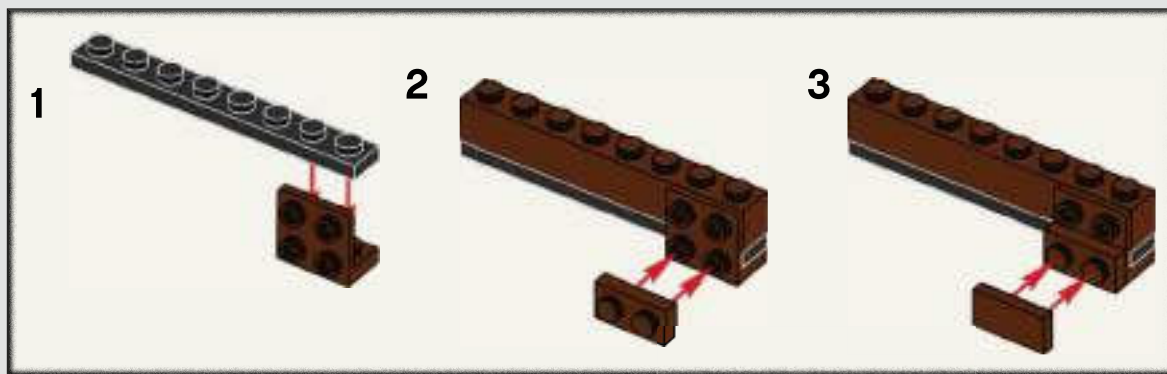



70

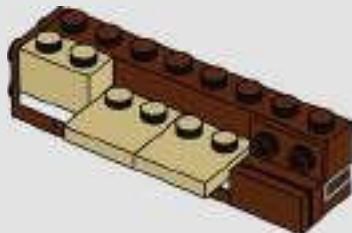

71

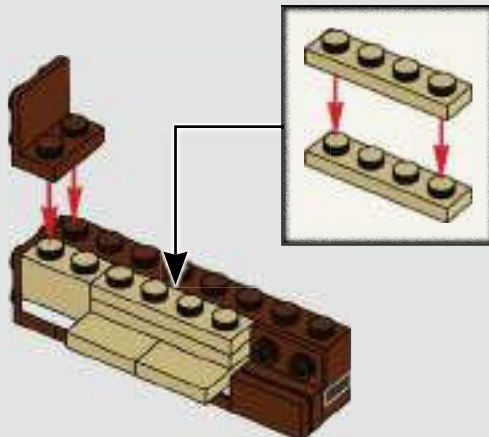

72

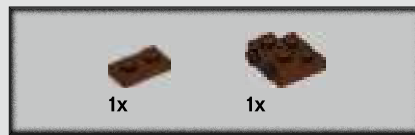
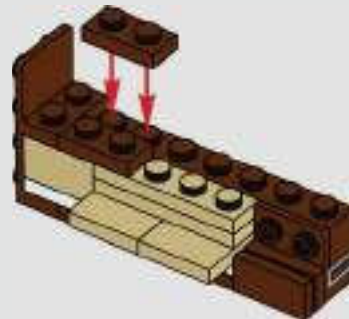

73

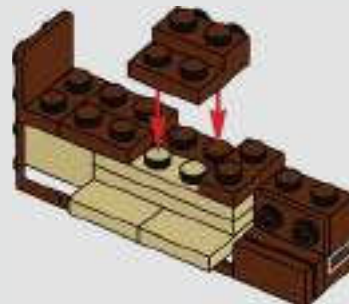



74

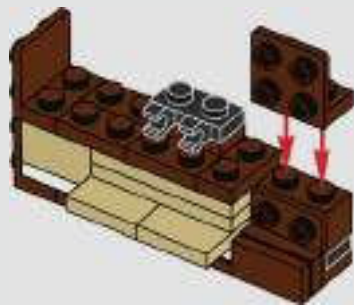

75

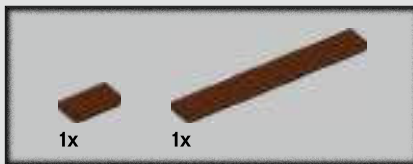
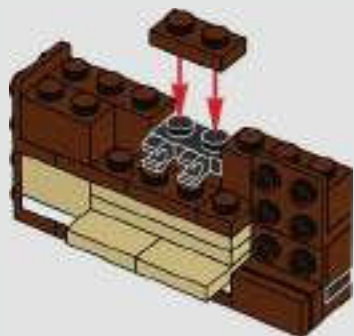

76

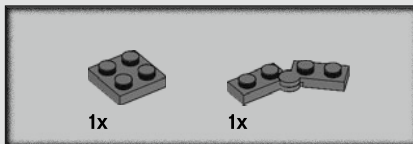
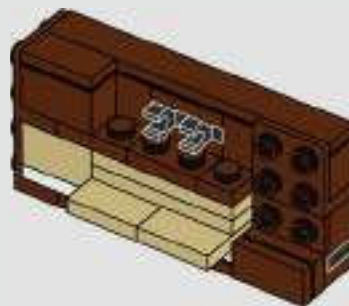

77

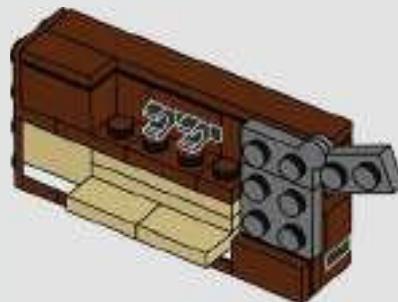



78

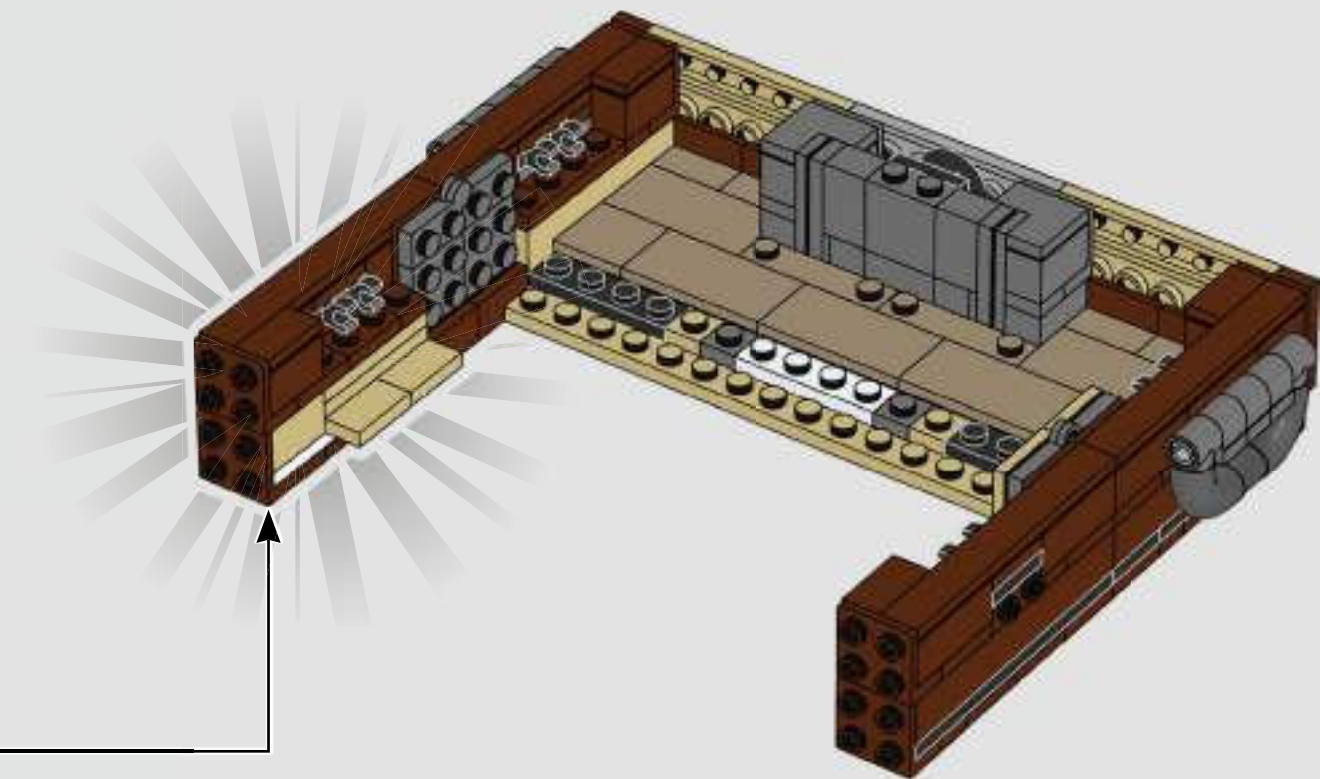



79

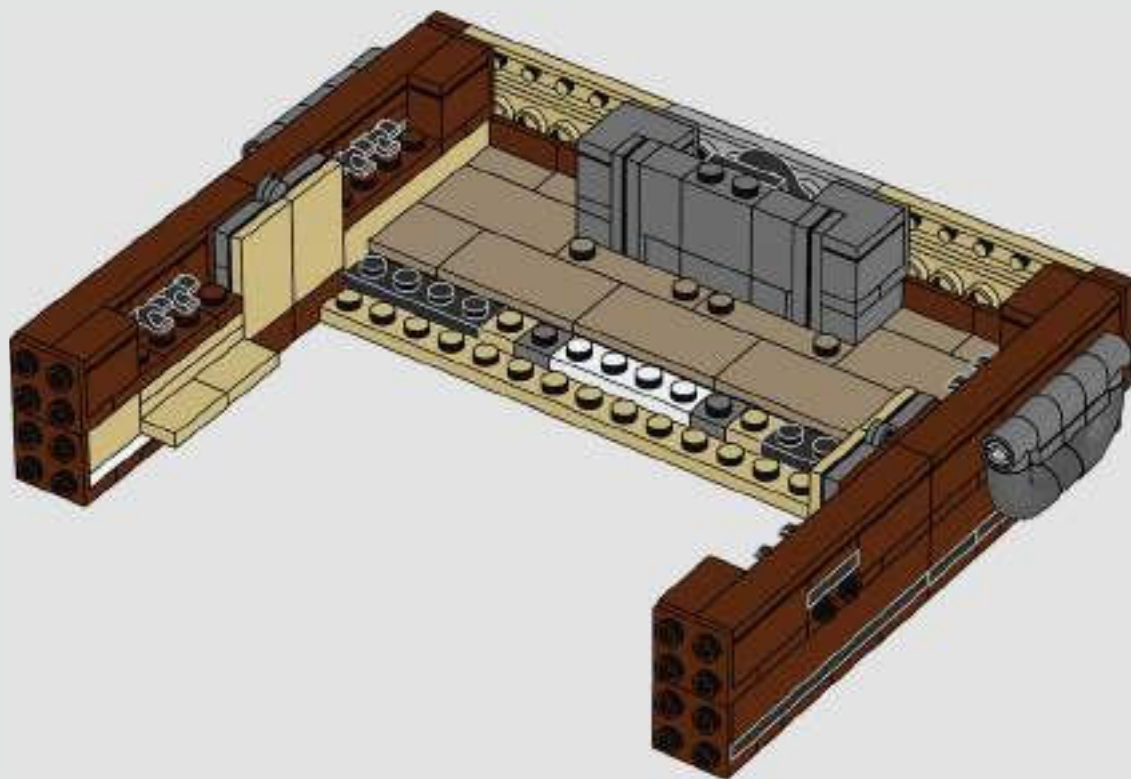

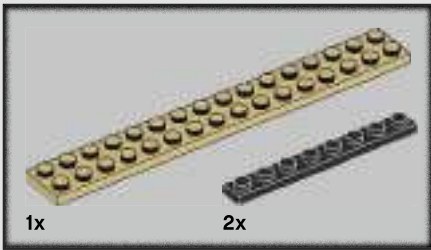

80

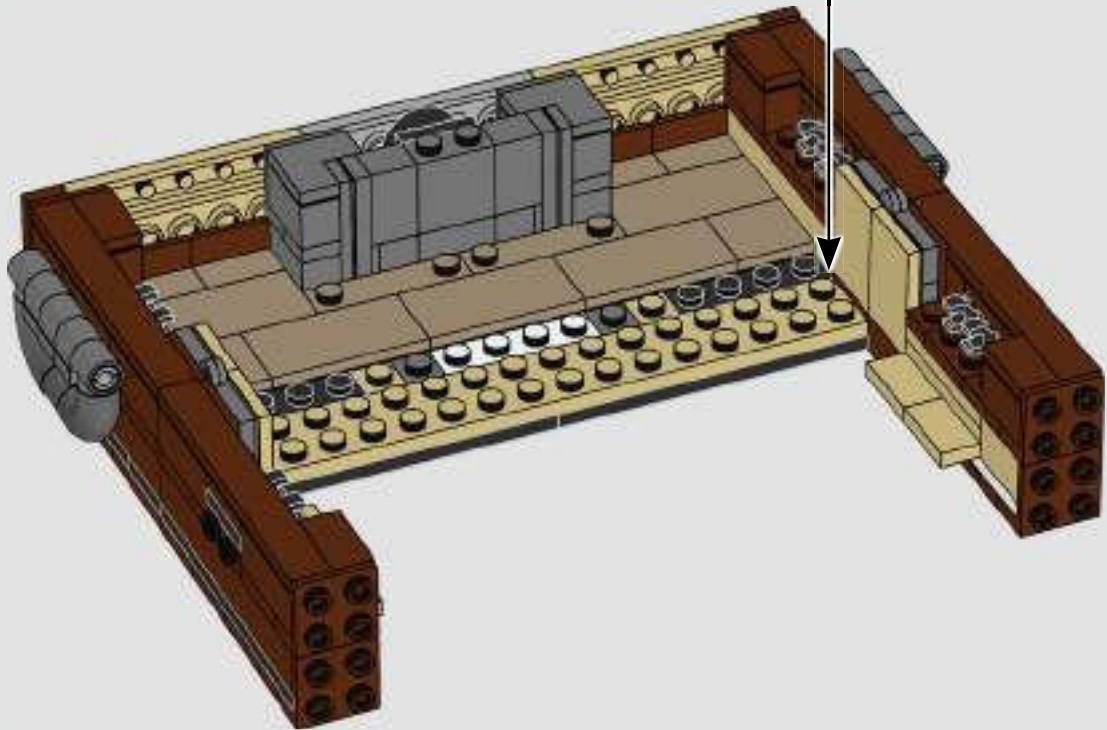
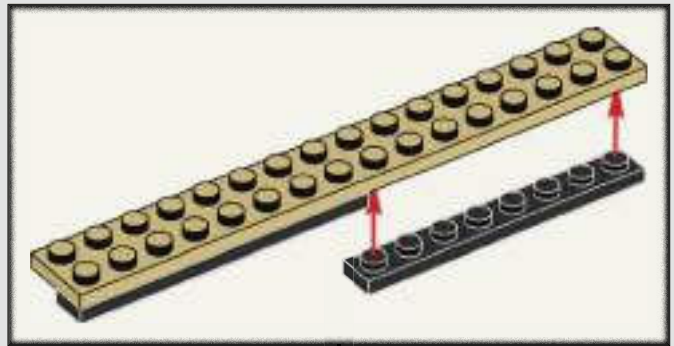



81

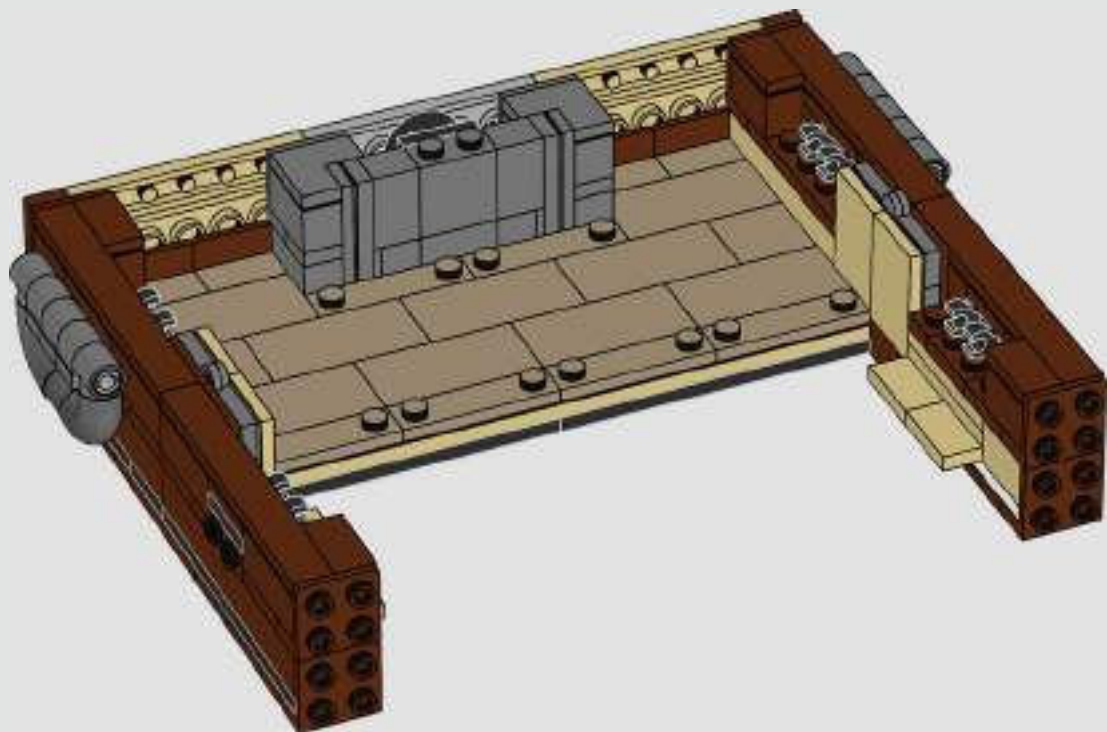

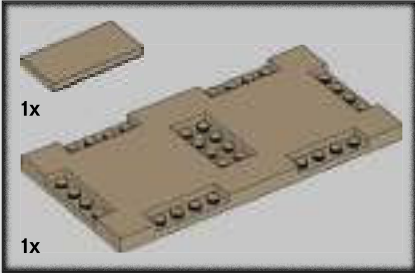

82

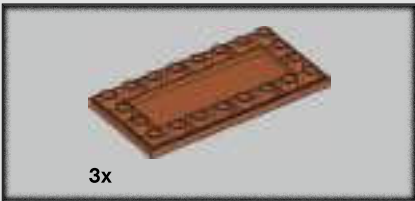
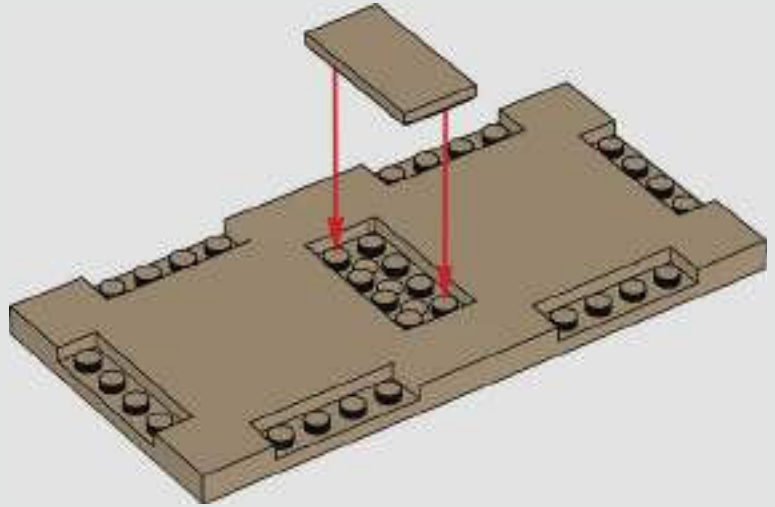

83

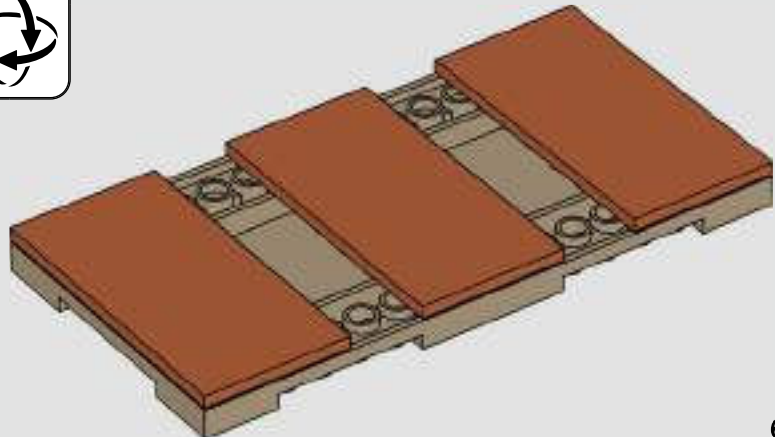
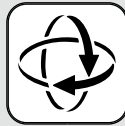



84

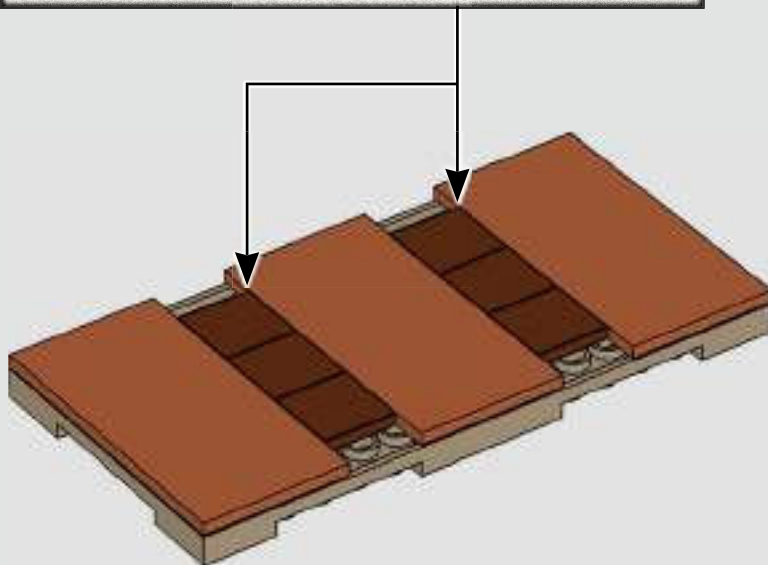
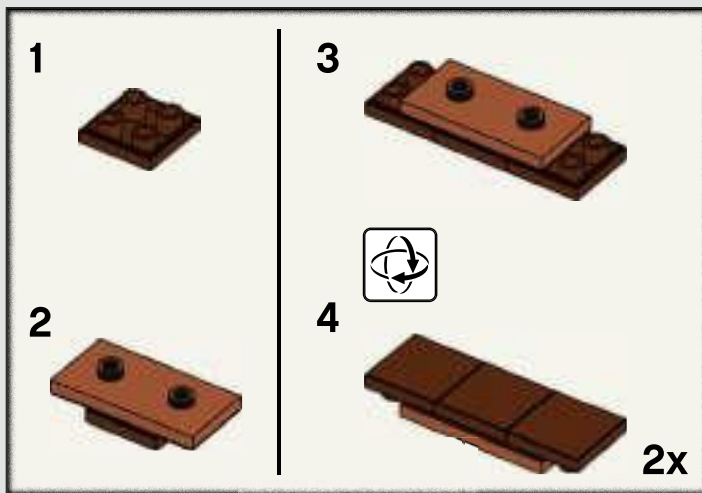



85

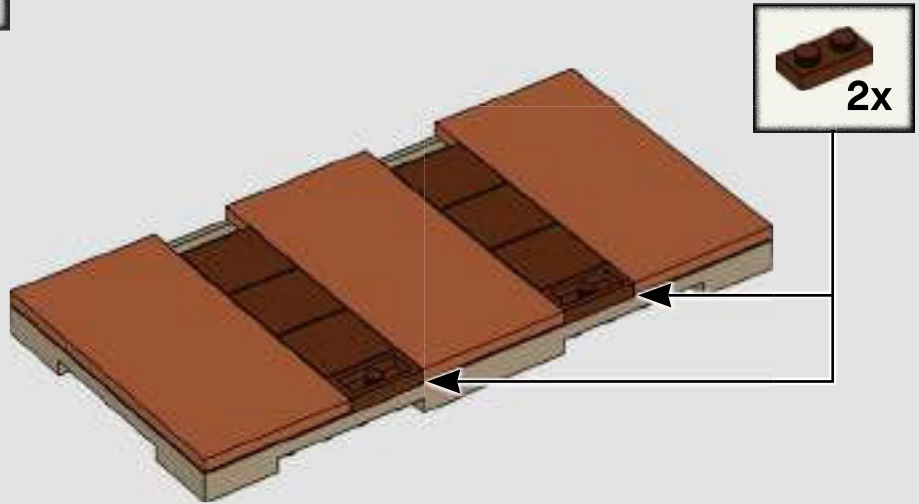

86

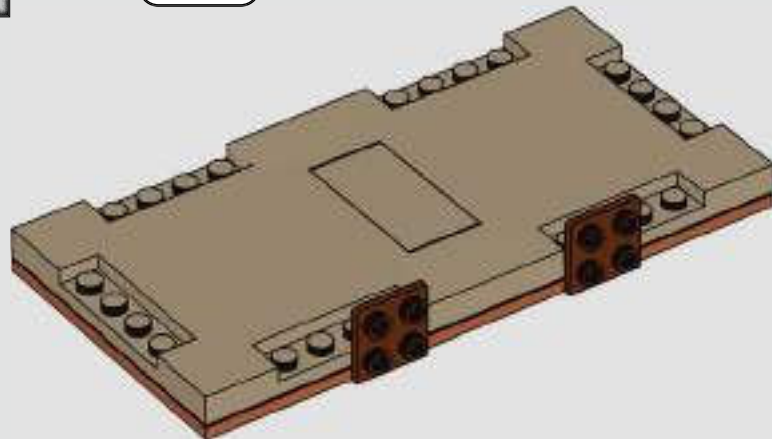
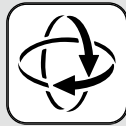



87

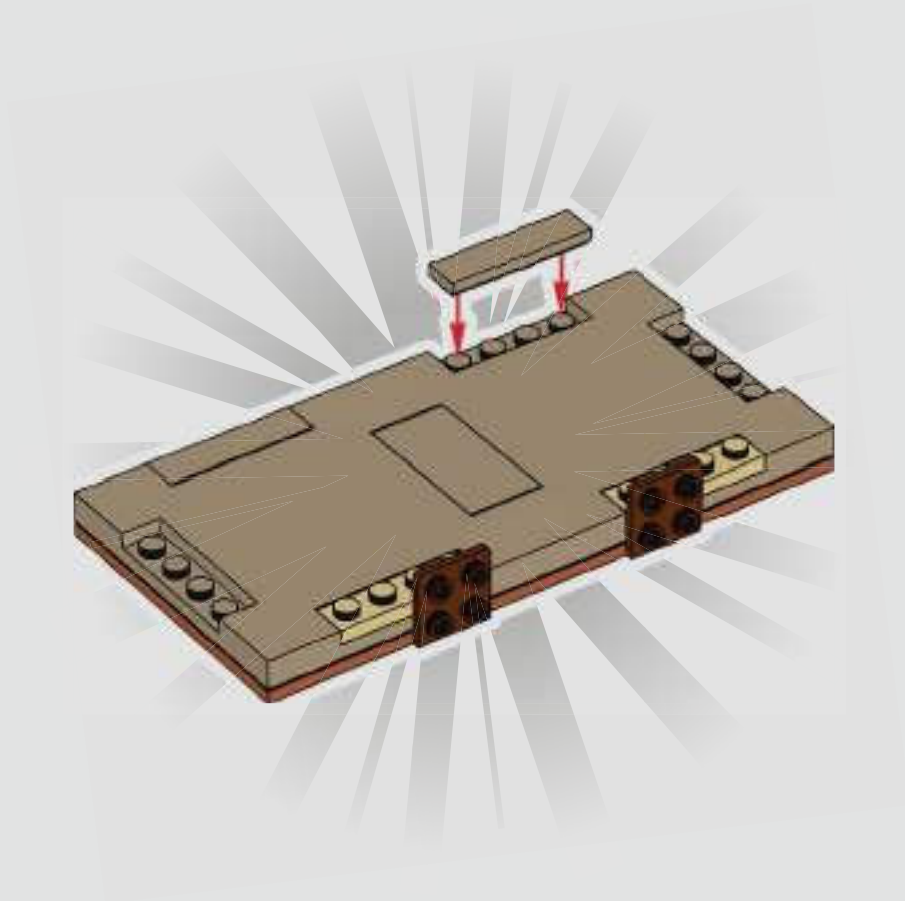



88

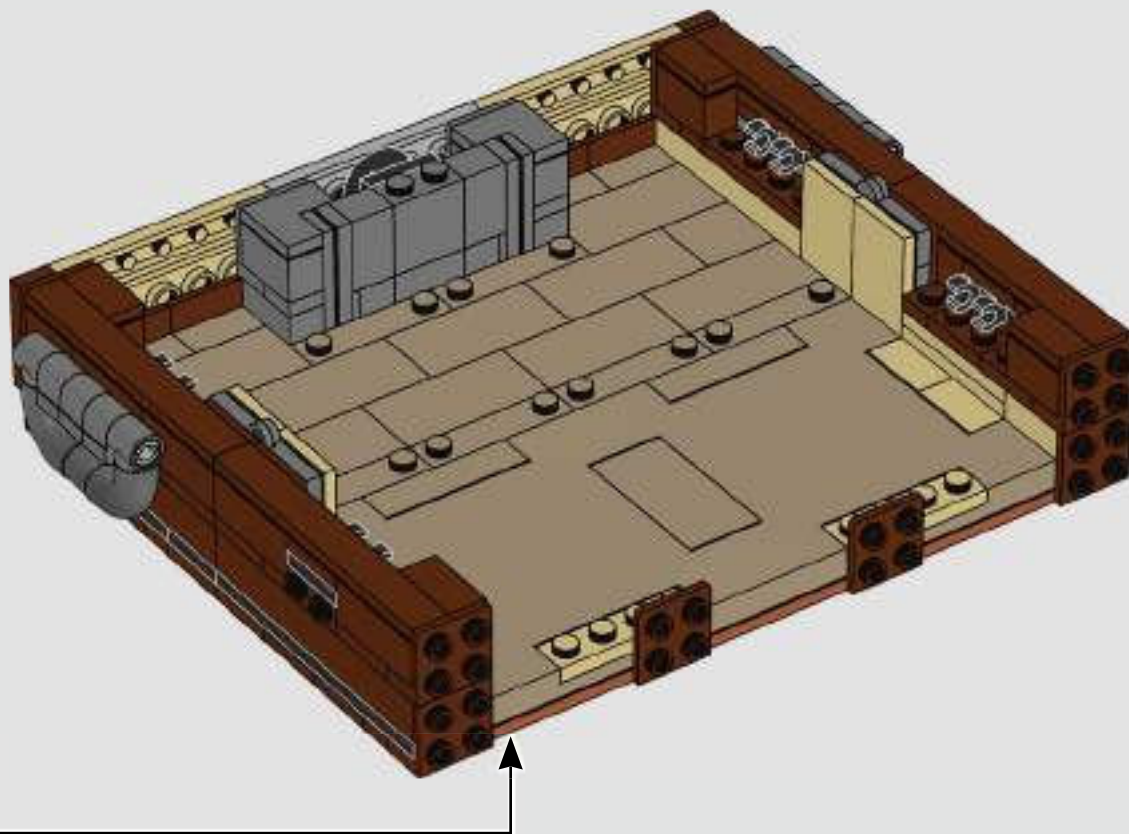

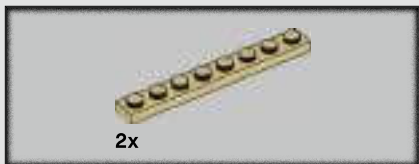

89

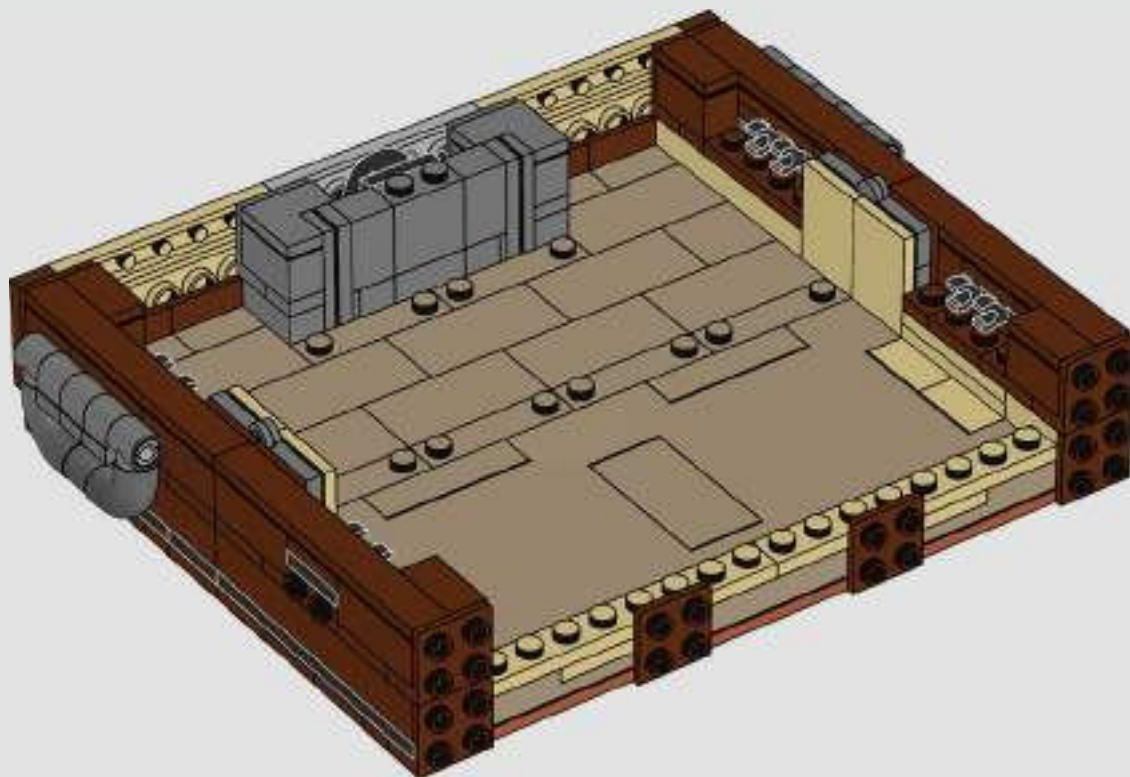

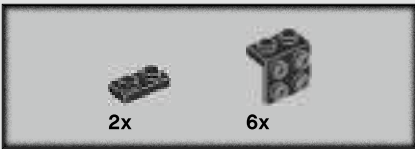

90

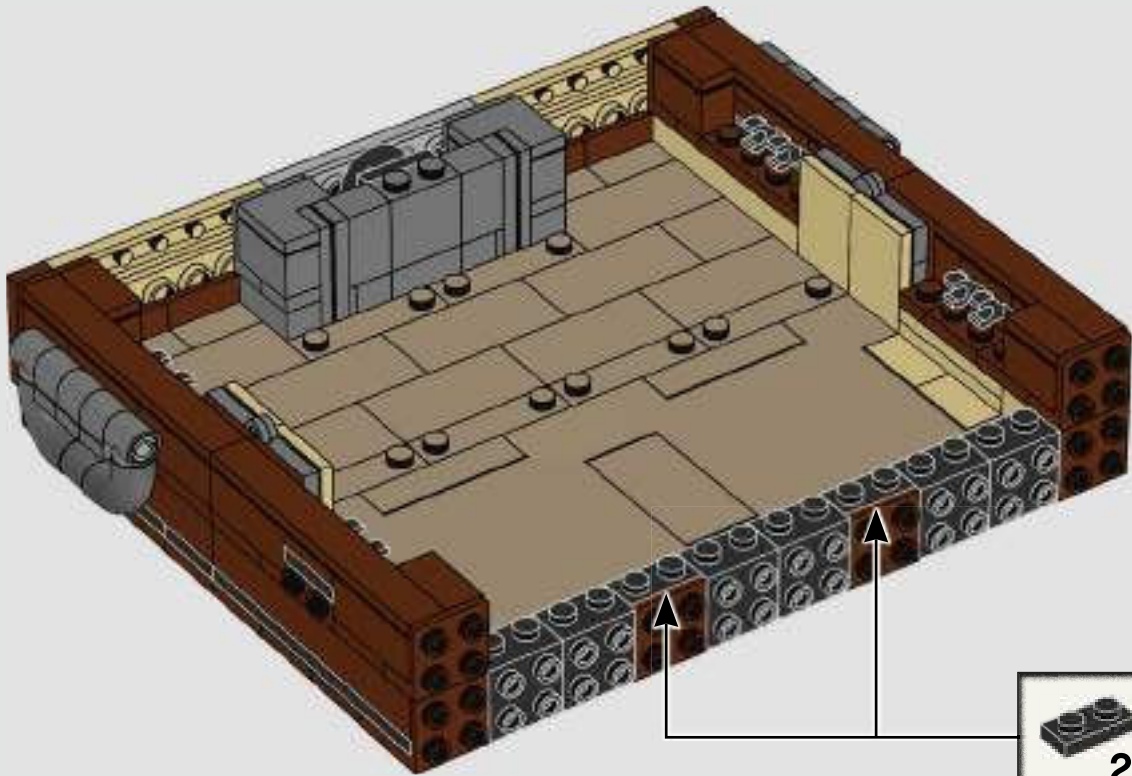



91

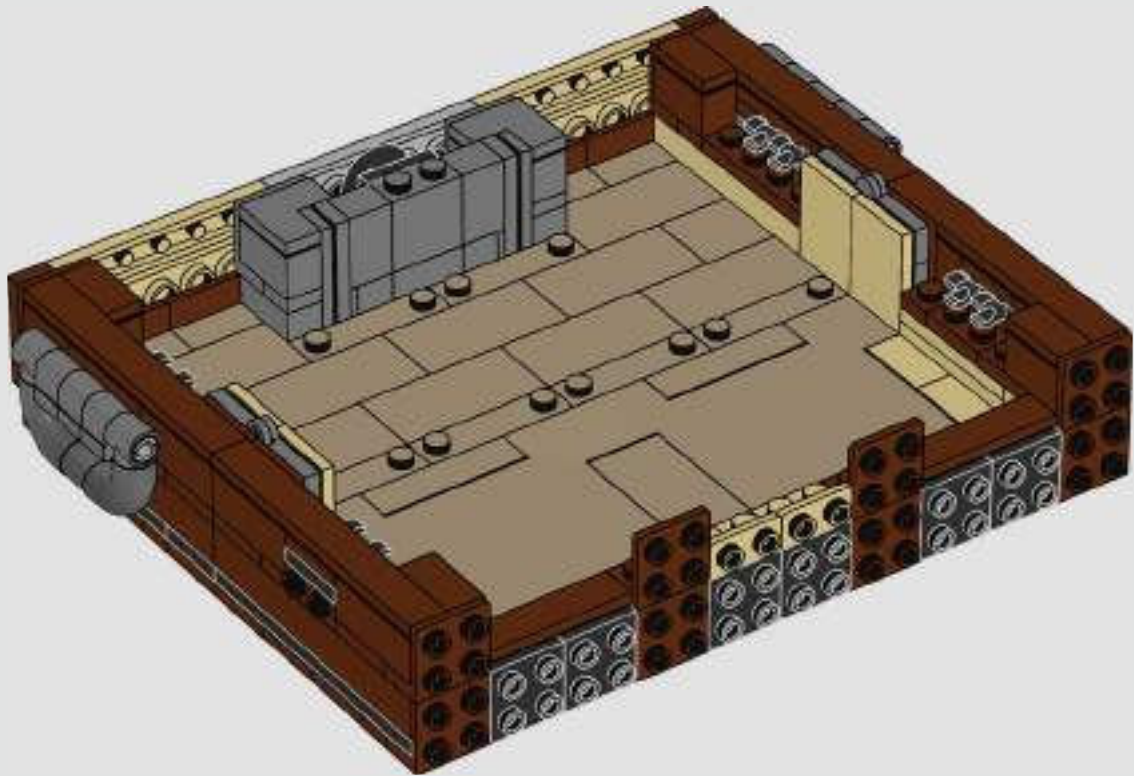



92

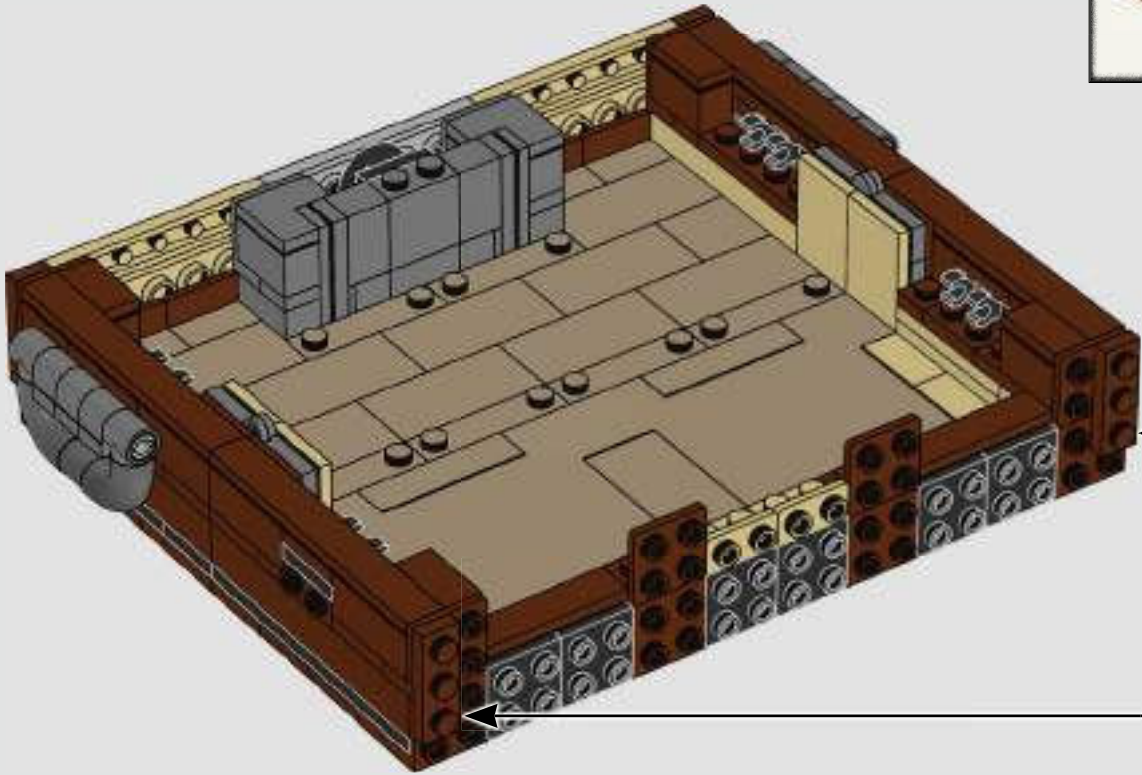
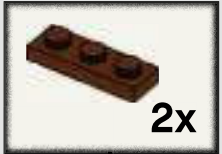

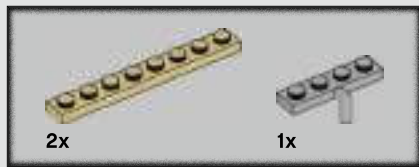

93

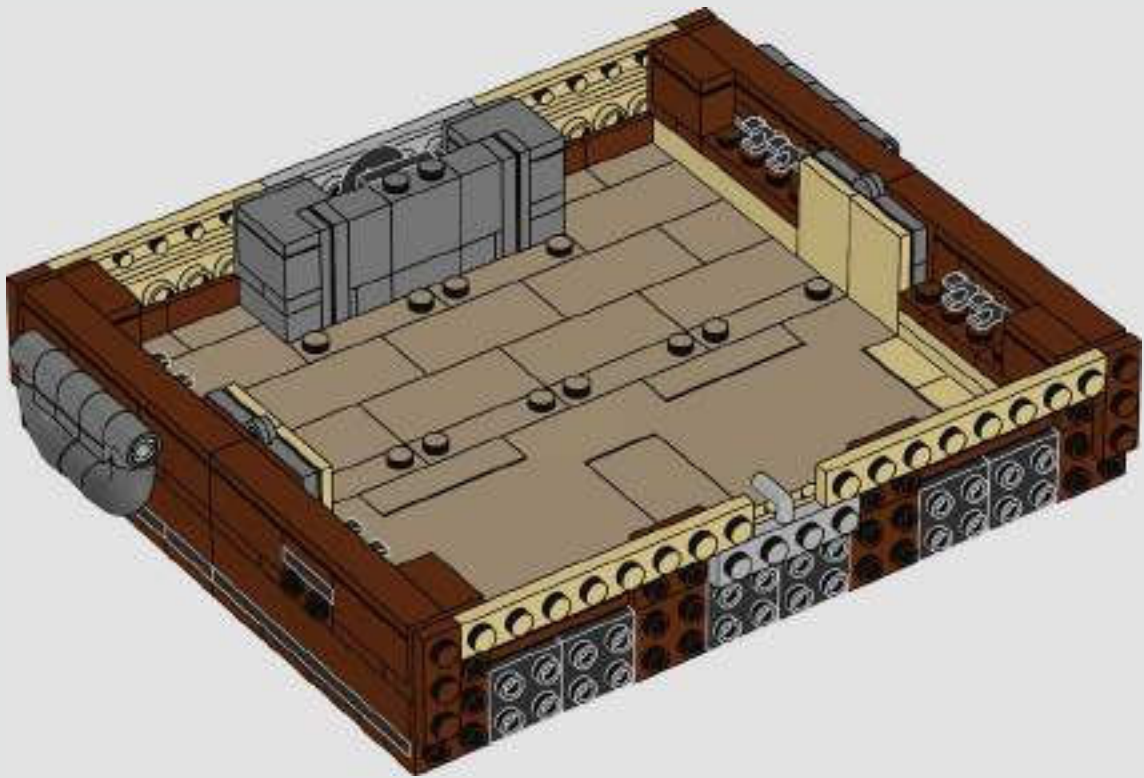



94

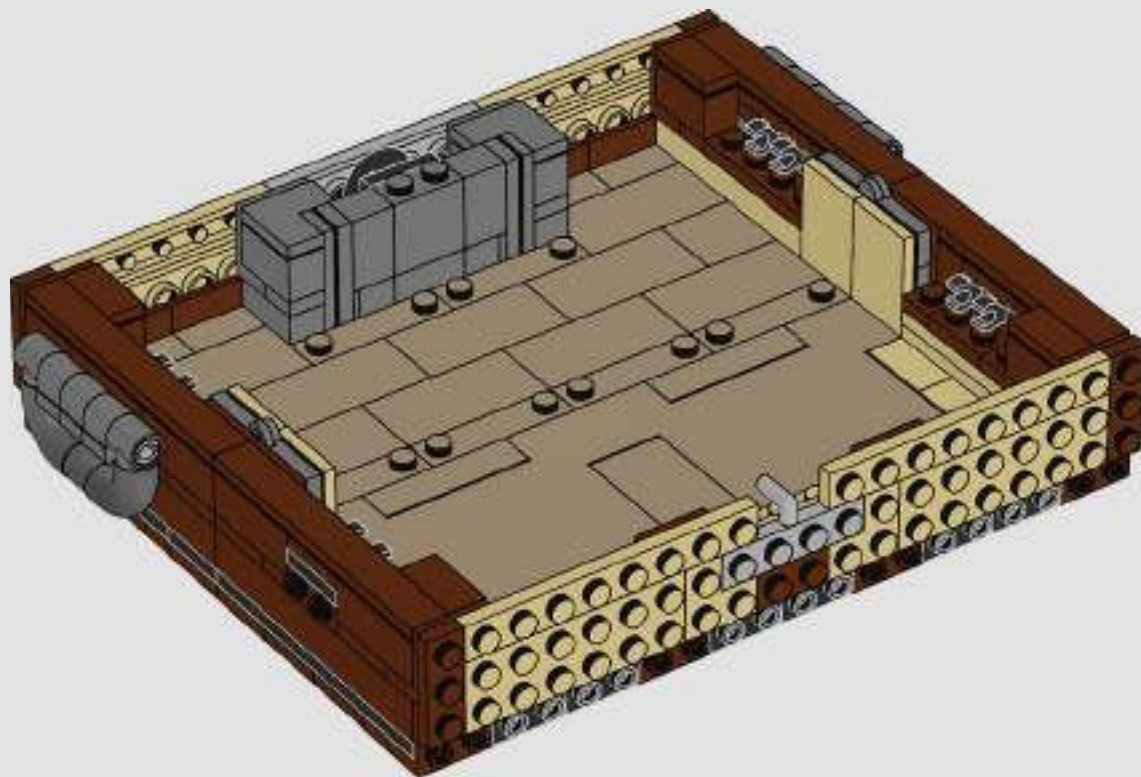





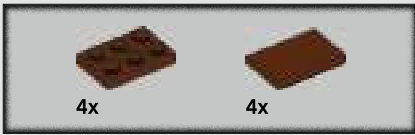

95

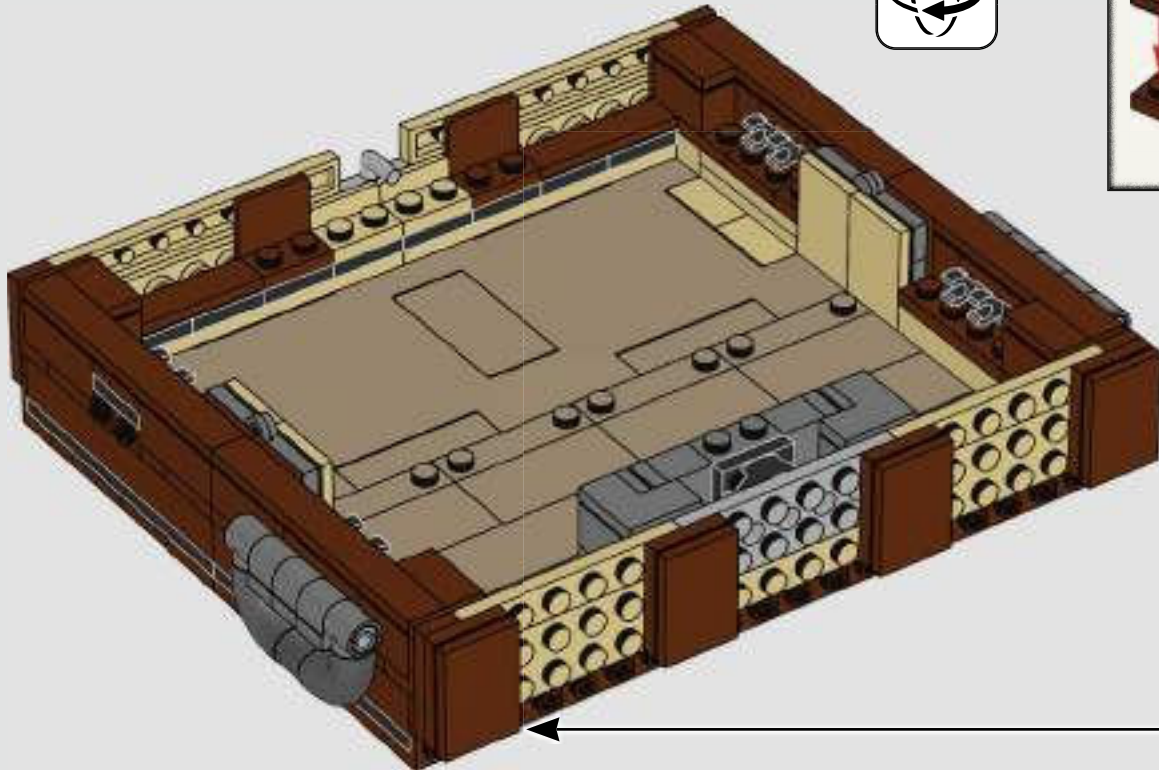
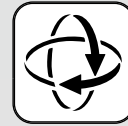

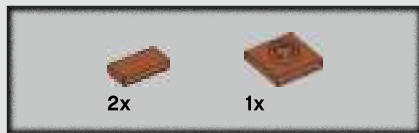

96

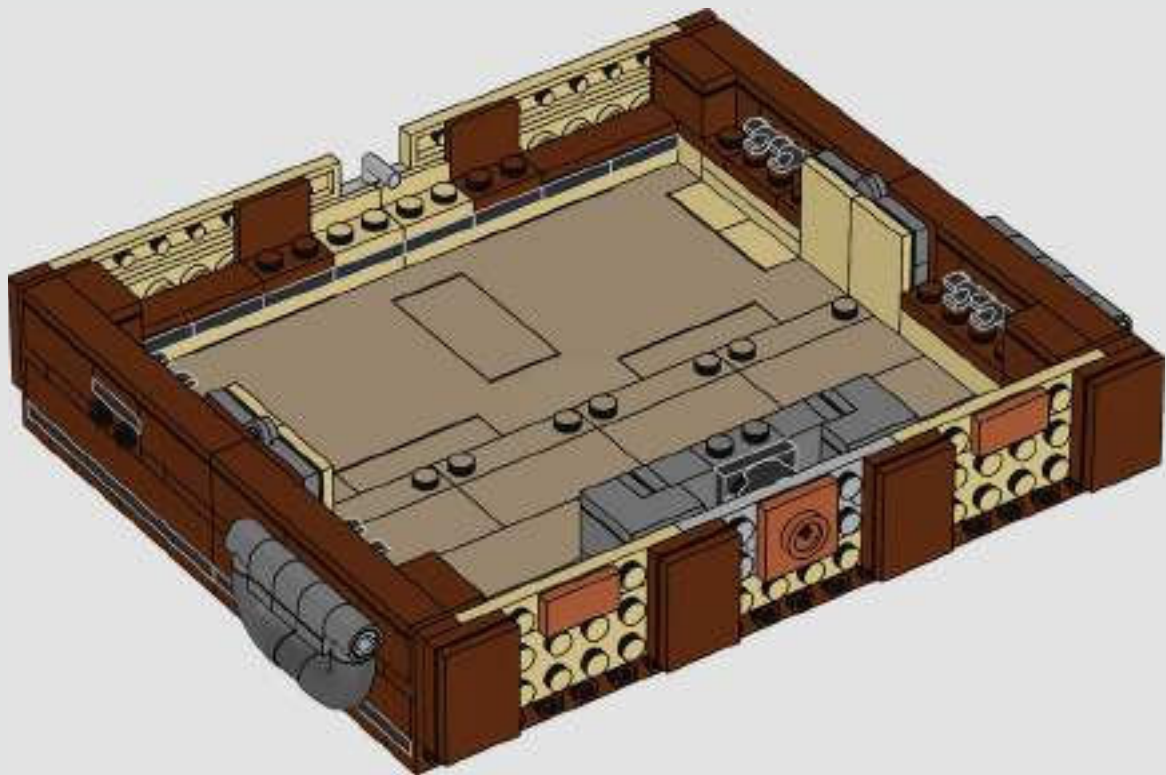

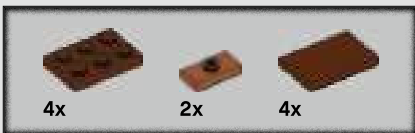

97

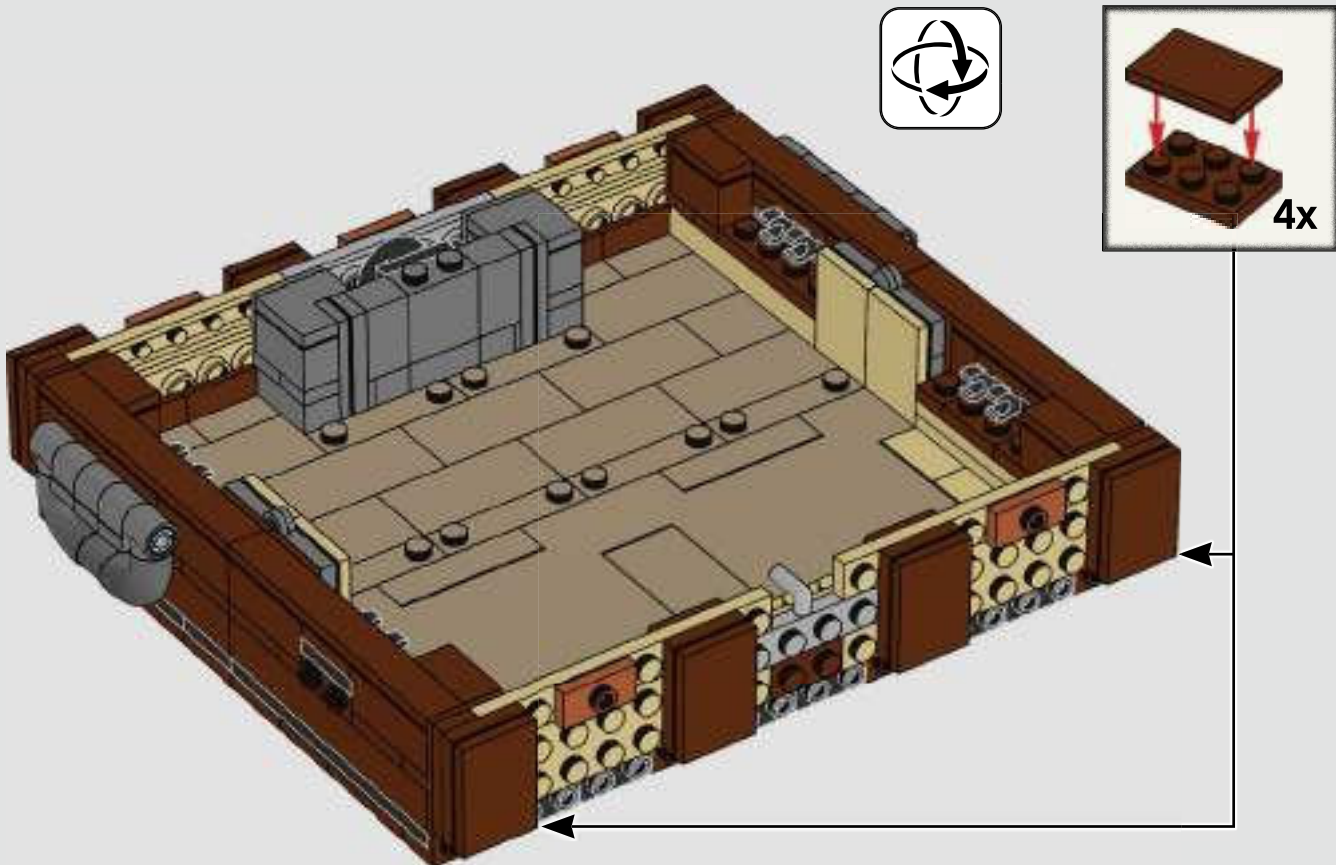

98

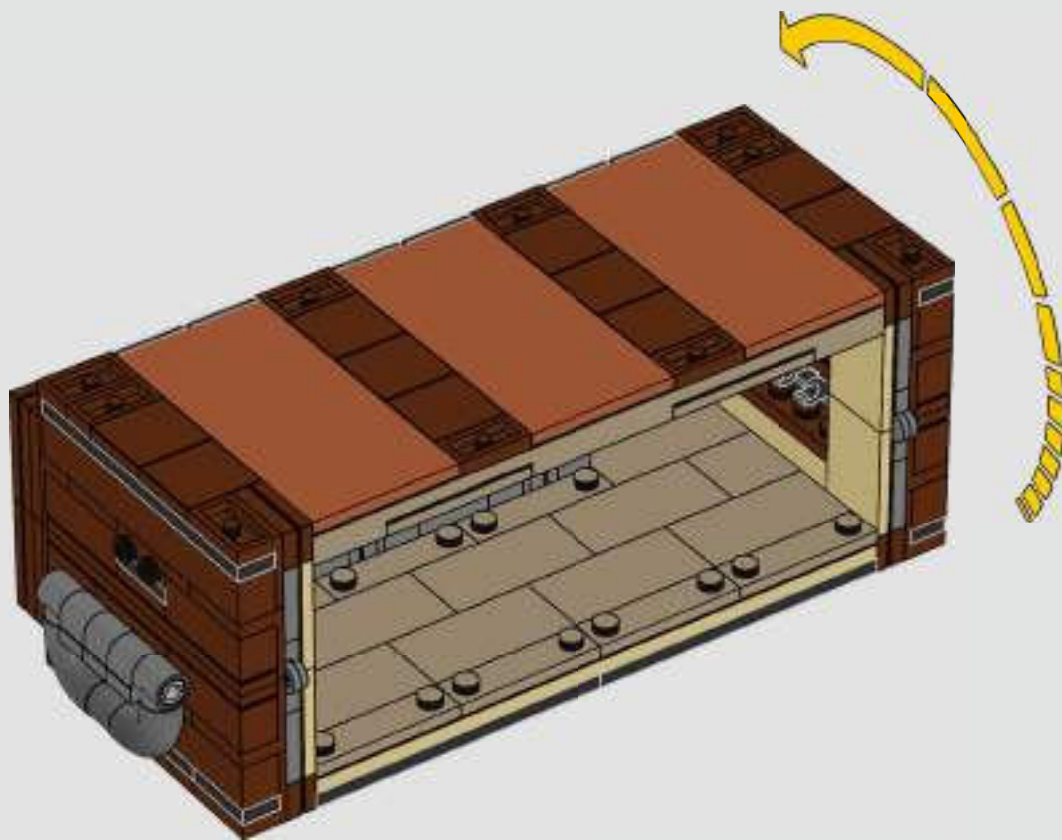



99

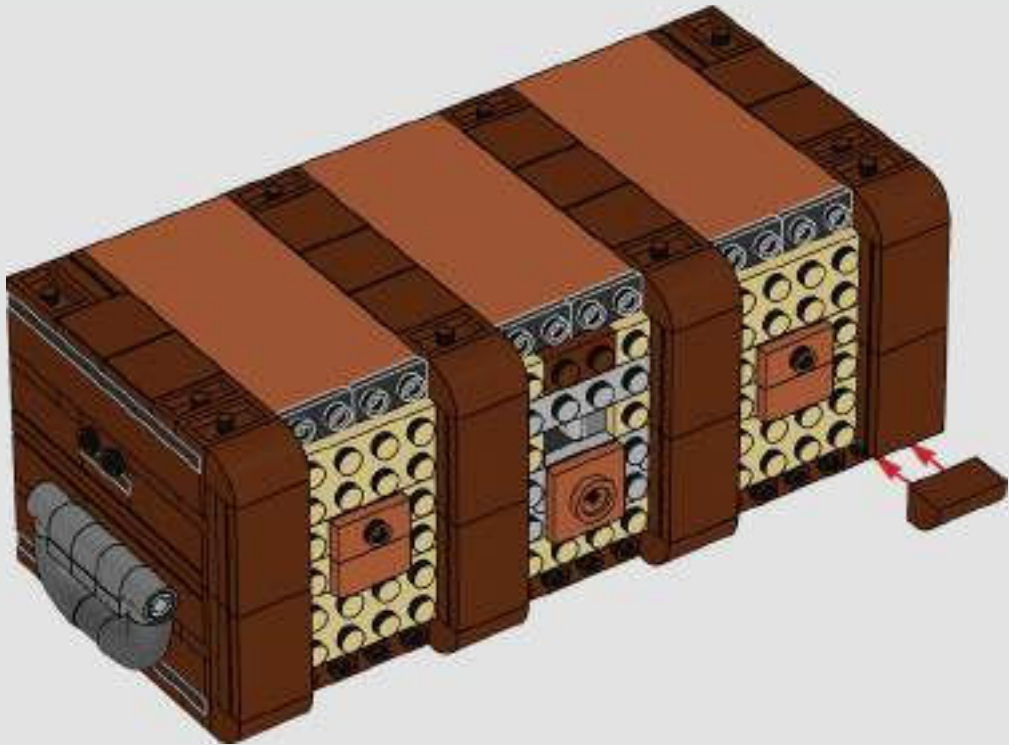

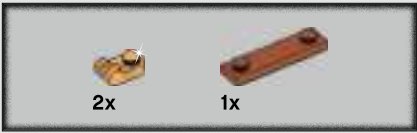

100

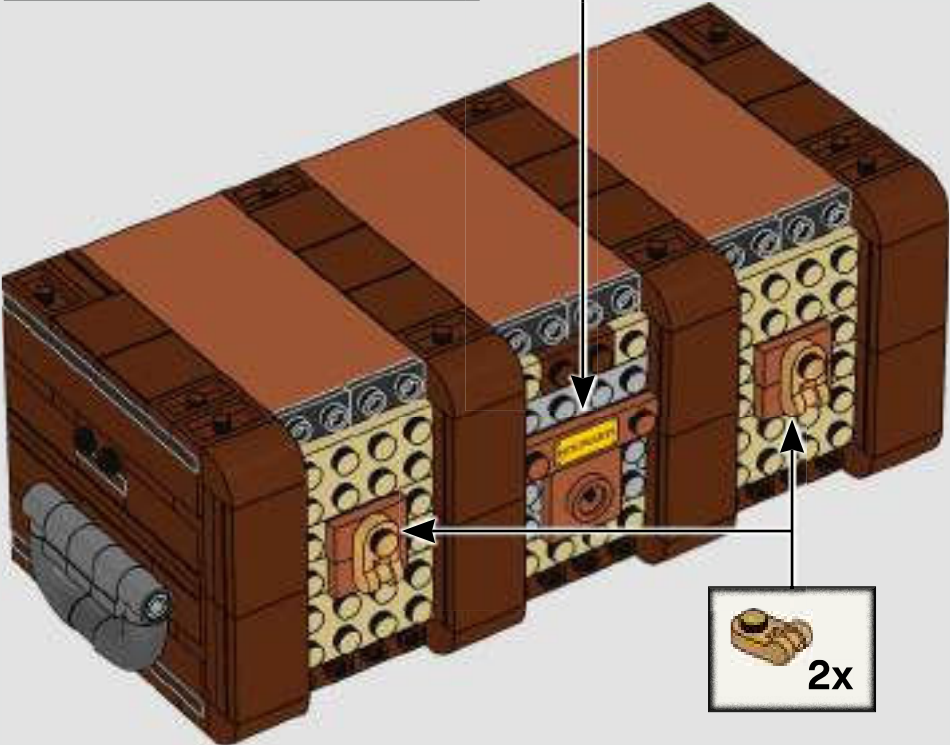
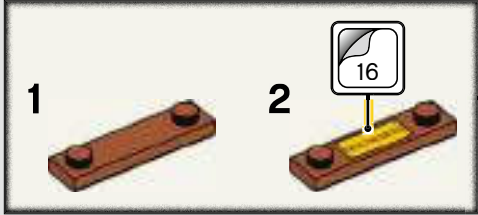



101



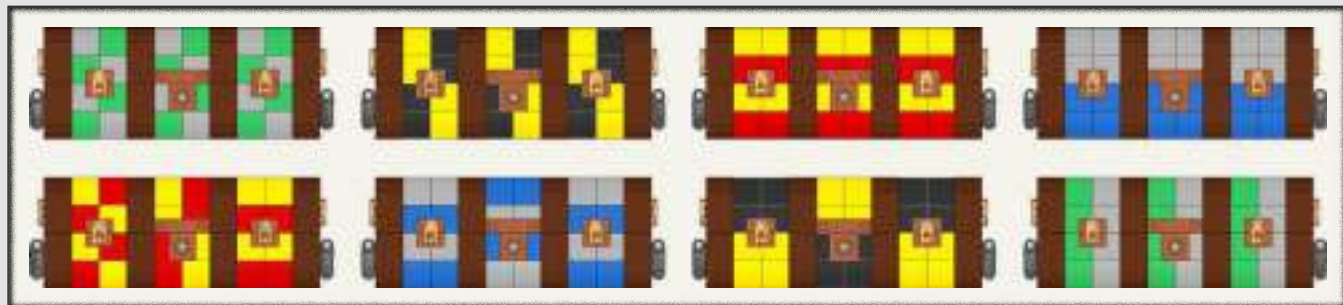
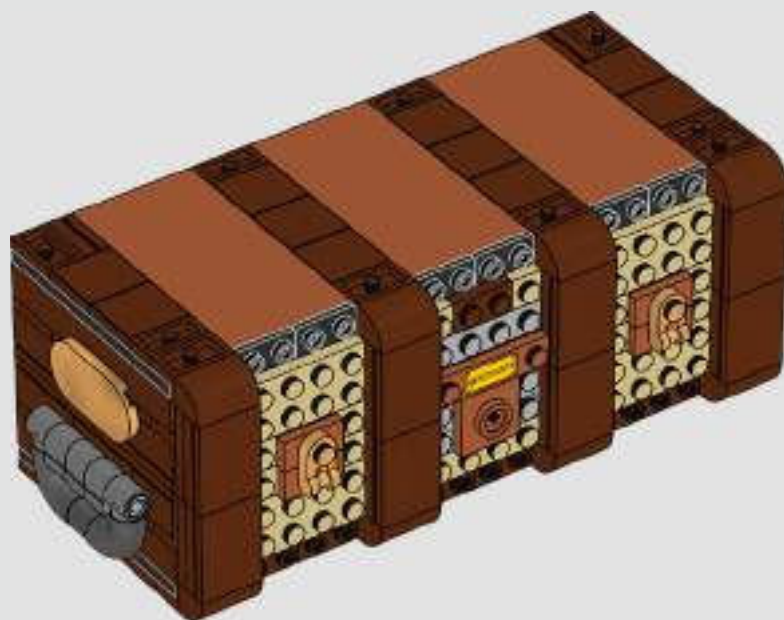



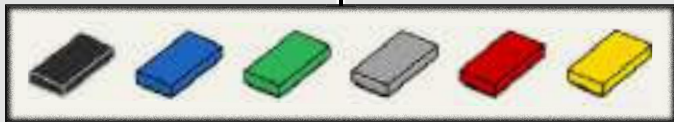
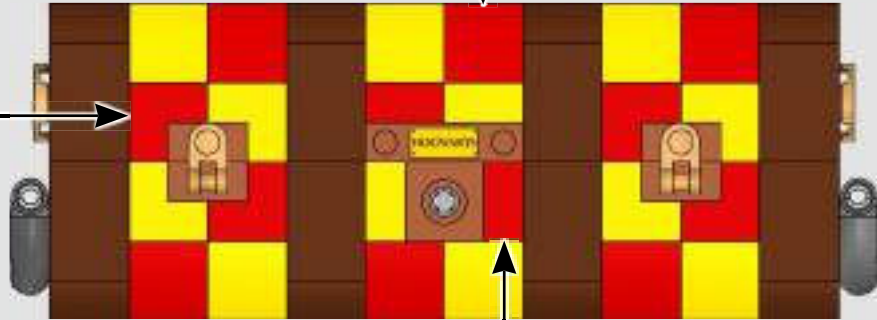
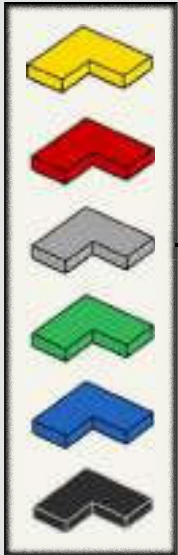
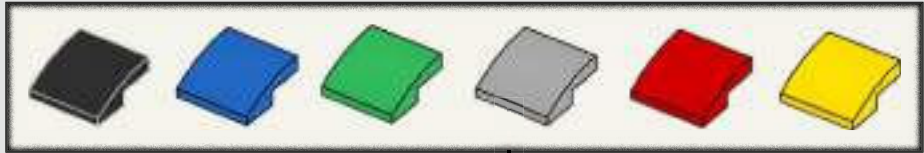

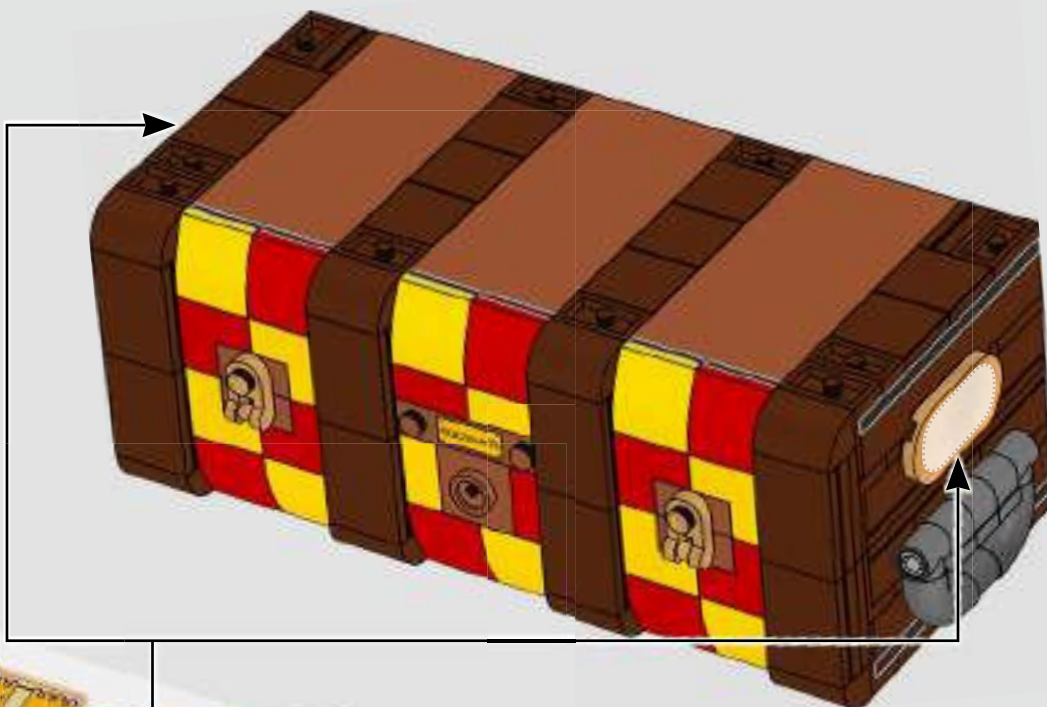

Permanent marker recommended for stickers. Adult supervision also recommended.

Für die Aufkleber werden Permanentmarker empfohlen. Kinder sollten von ihren Eltern beaufsichtigt werden.

Marqueur permanent recommandé pour les autocollants. La surveillance d'un adulte est aussi recommandée.

Pennarello indelebile consigliato per gli adesivi. Raccomandata anche la supervisione di un adulto.

Se recomienda escribir en las pegatinas con un rotulador permanente. También se recomienda la vigilancia de un adulto.

Recomenda-se o uso de marcador permanente para os autocolantes. Também se recomenda a supervisão de um adulto.

A matricákhoz az alkoholos filctollat javasoljuk. Egy felnőtt felügyeletét is javasoljuk.

Uz uzlīmēm ieteicams izmantot permanento marķieri. Ieteicams lietot pieaugušā uzraudzībā.

建议粘贴永久性标记。建议成人陪伴。



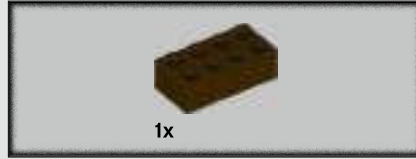

102



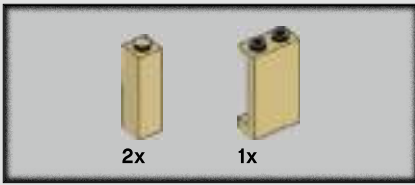

103

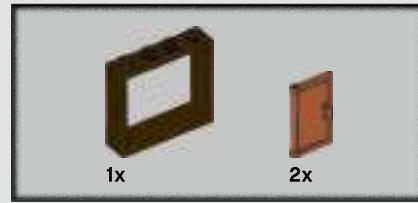
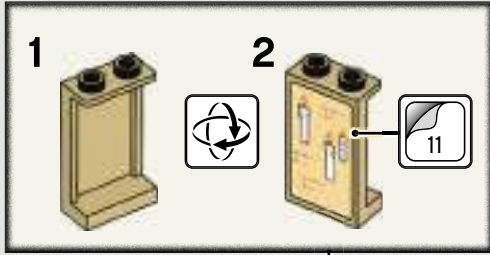

104

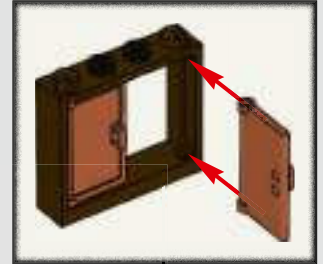

105





106



107

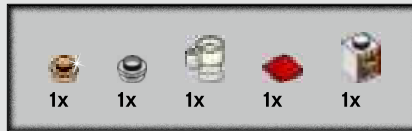

108

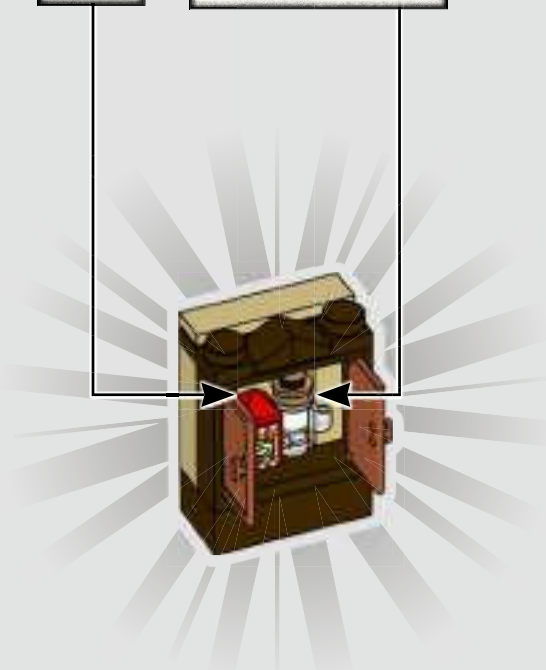
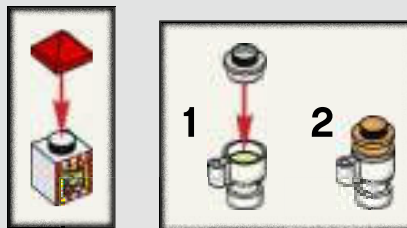

109

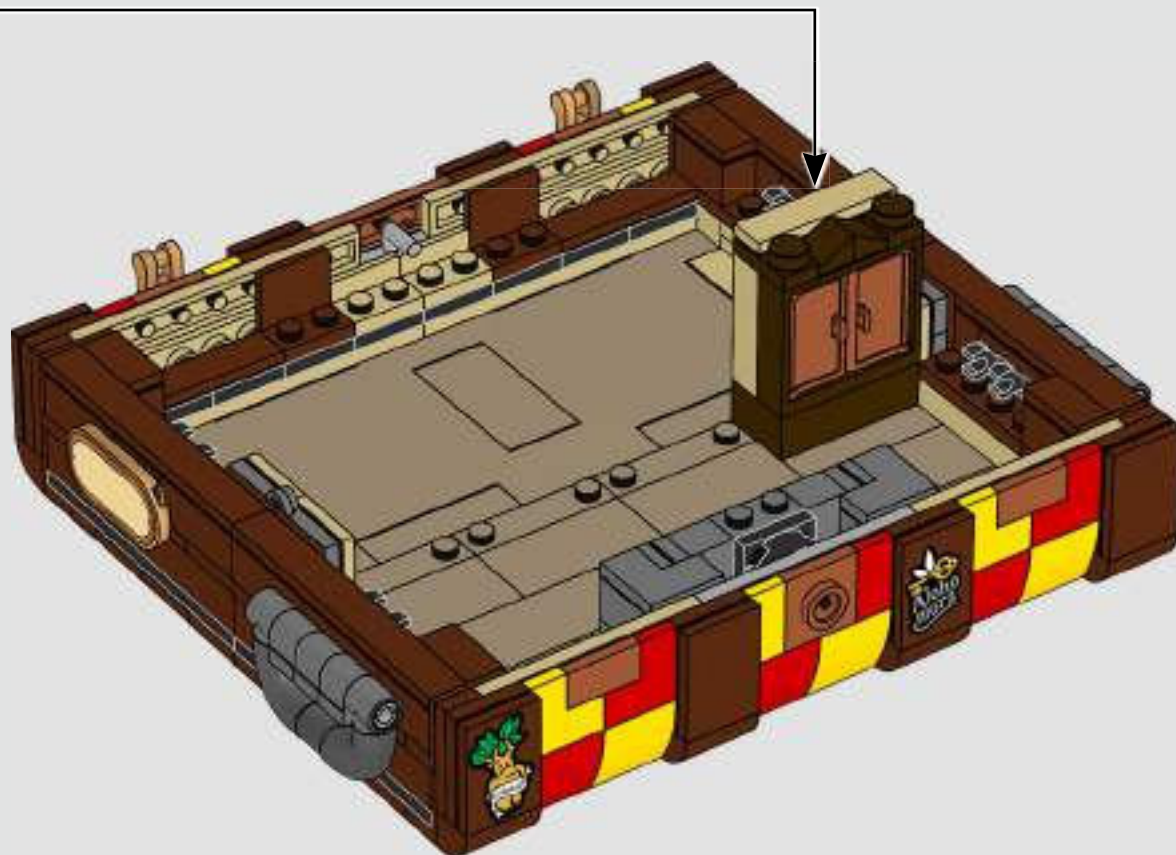

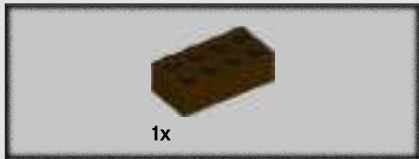

110

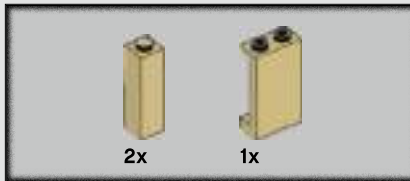

111

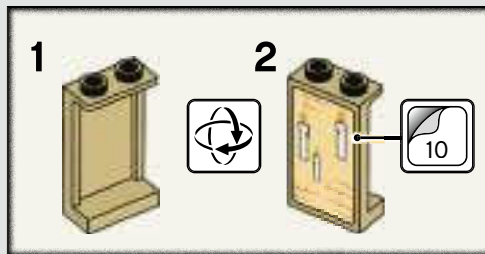



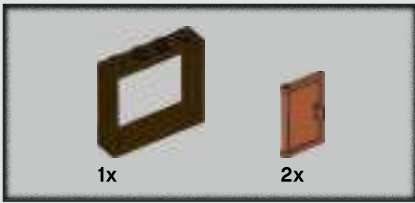

112

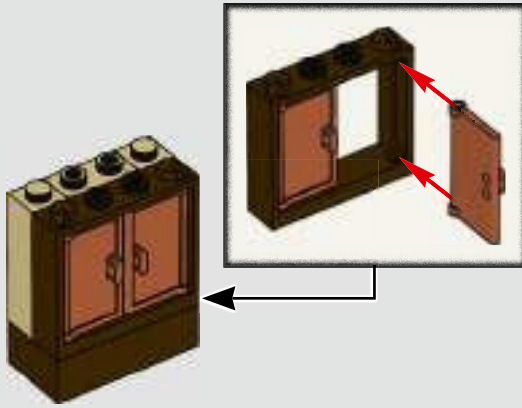

113

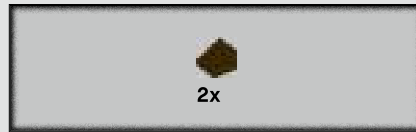

114



115





116

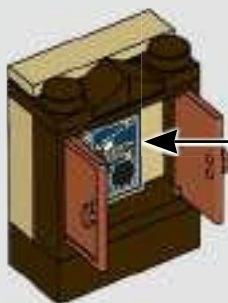

117

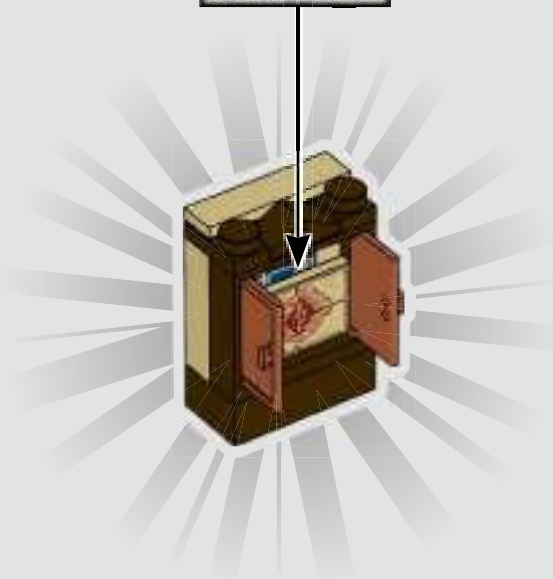

118

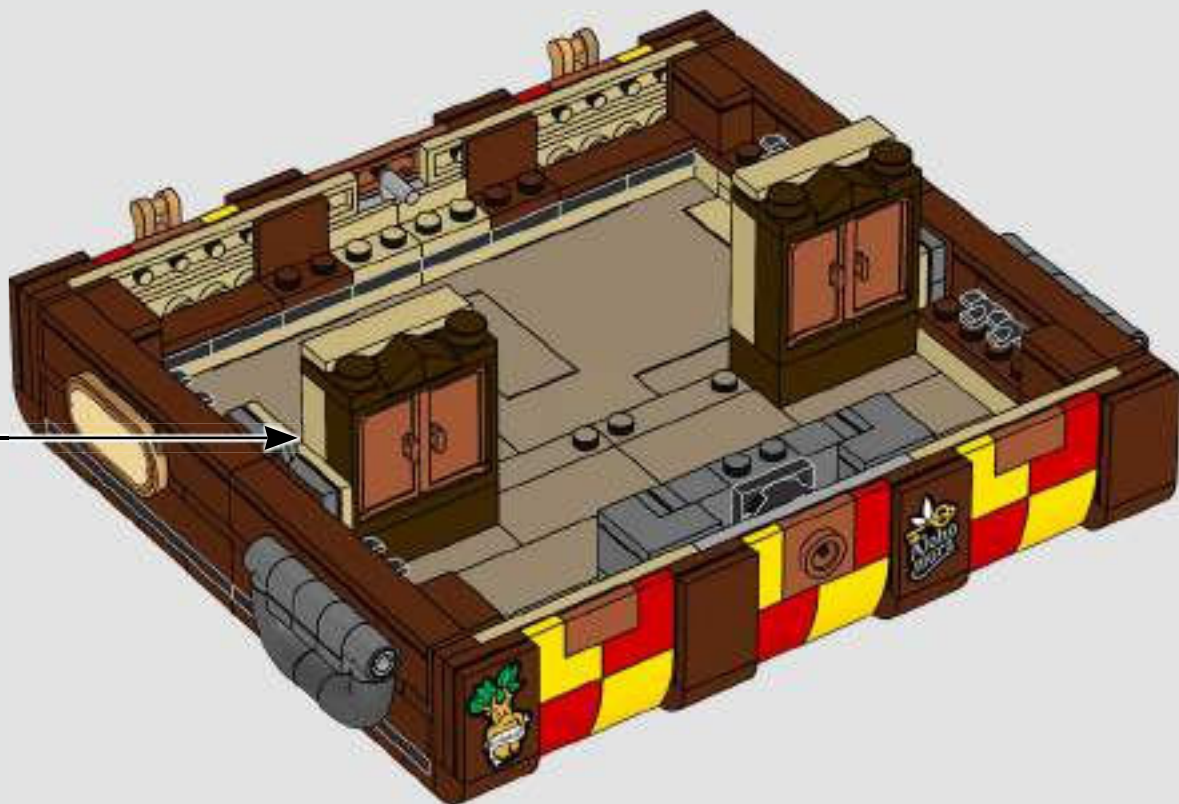

119





120

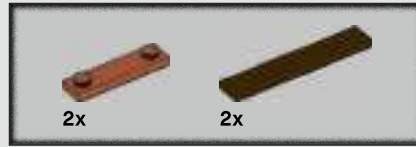

121

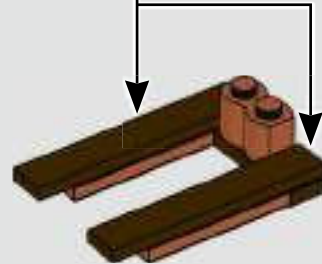
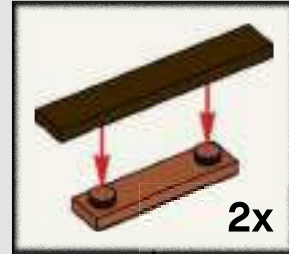



122

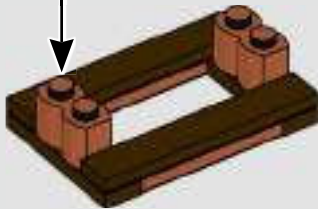
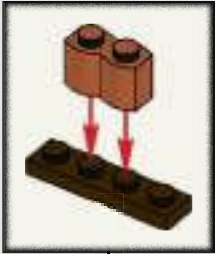

123

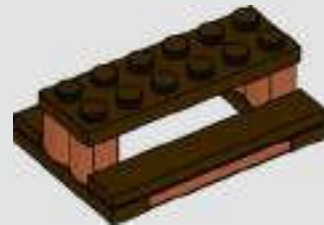



# 124

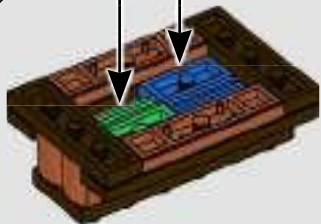
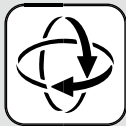
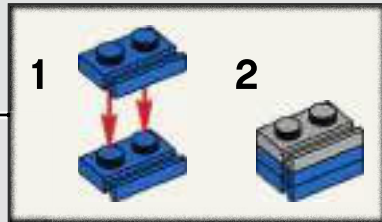
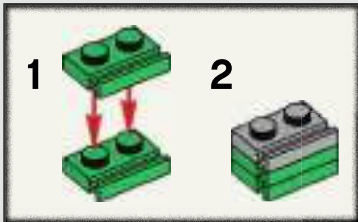



125

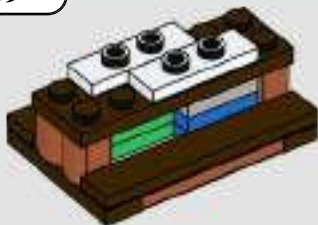

126



127







128

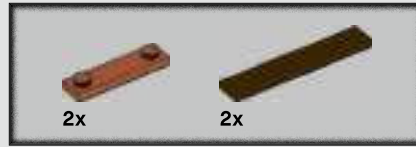

129

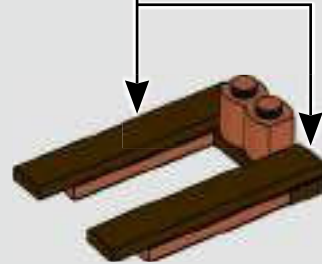
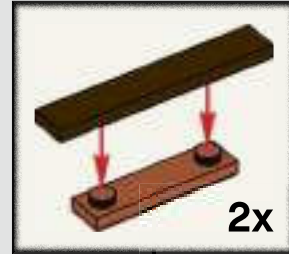



130

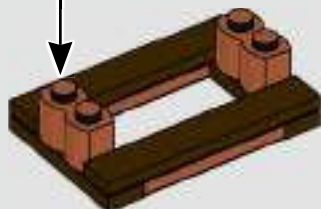

131





132

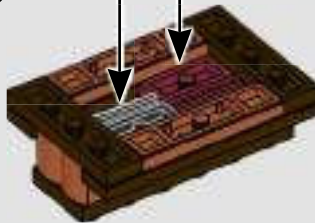
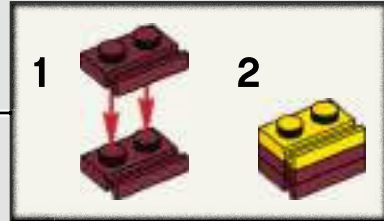
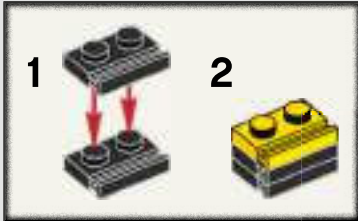

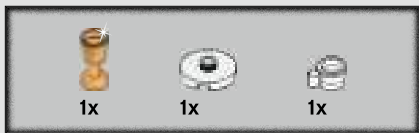

133

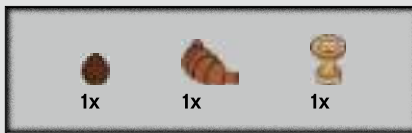
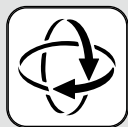

134



135





**136**



**137**



**138**



**139**





140

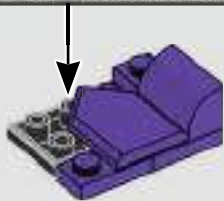
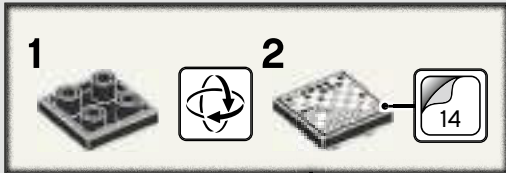

141



142



143

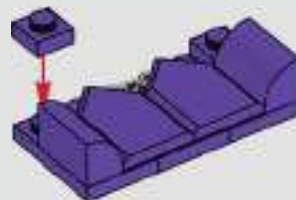



144

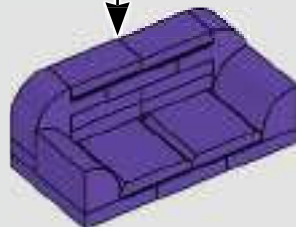
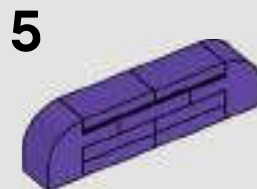
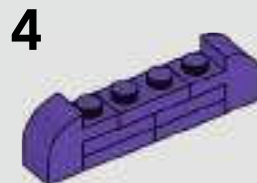
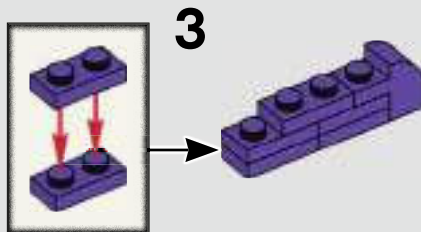
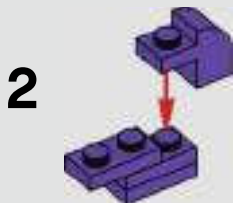
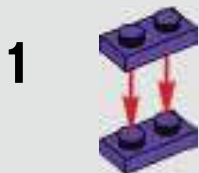





145



146



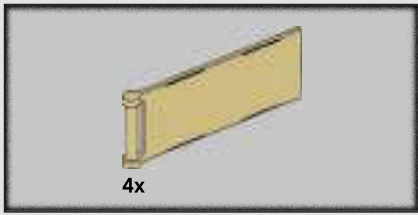

4x

147

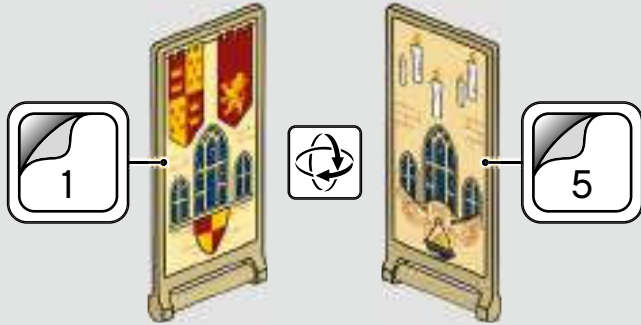

148

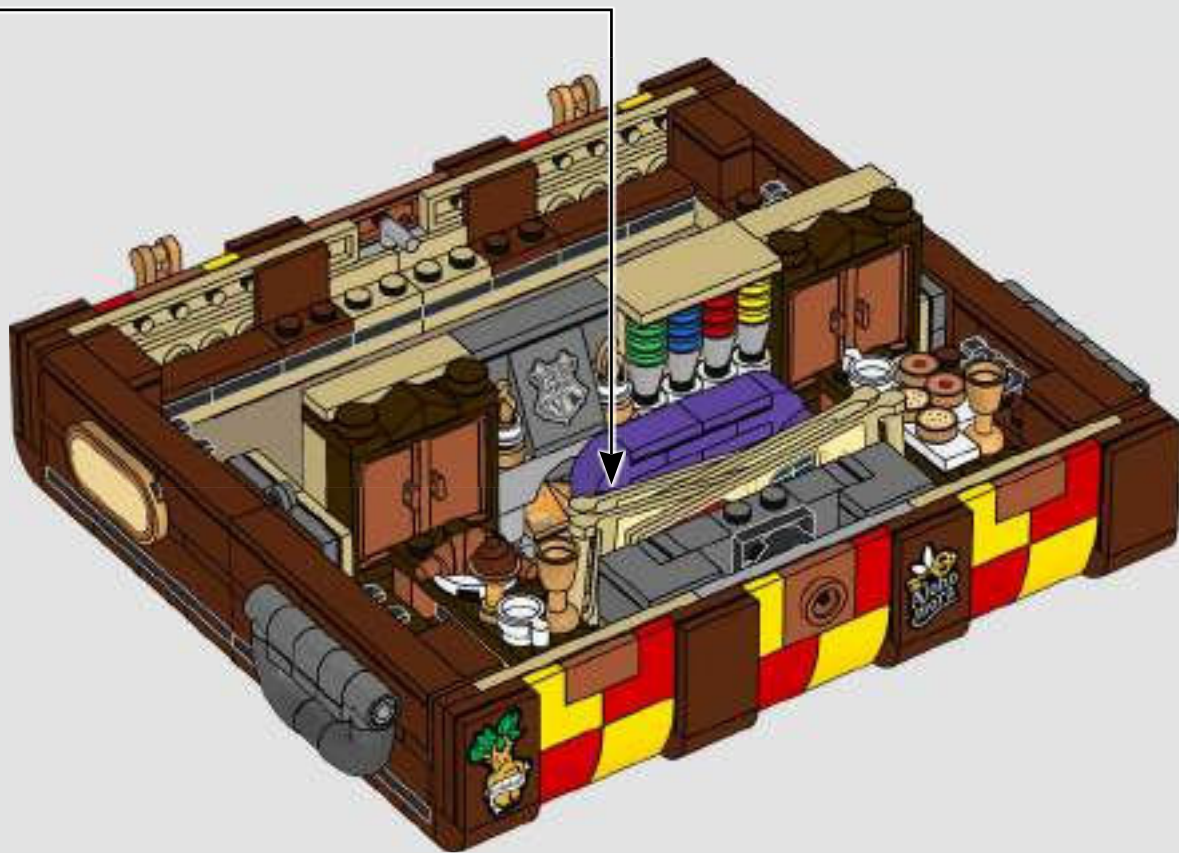

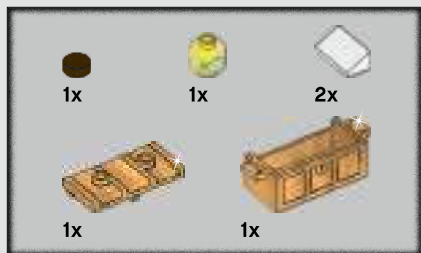

149

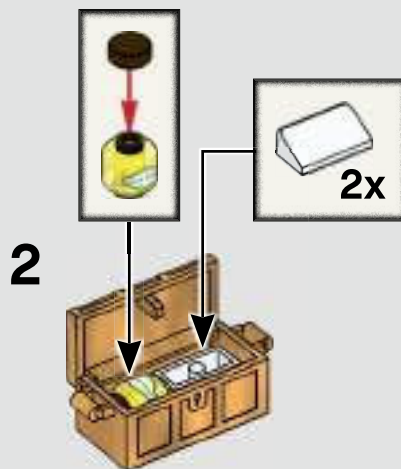
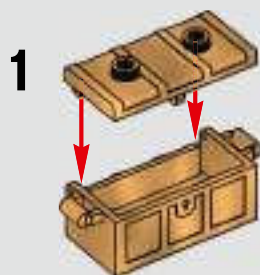

150





151







152

1



2



3



4



5



6







Build,  
Rebuild,  
Play



Alakomora

阿拉霍洞开 (开锁咒)



The Sorting Ceremony



The Great Hall  
Welcoming Feast



The Common Room

Build, ReBuild, Play  
 Bauen, umbauen, spielen  
 Construis, reconstruis, joue  
 Costruisci, ricostruisci, gioca  
 Construye, reconstruye, juega

Constrói, Reconstrói, Brinca  
 Építsd meg, alakítsd át, játssz vele!  
 Būvē, pārbūvē, rotaļājies  
 拼搭、重新拼搭、玩乐

The Sorting Ceremony

The Sorting Ceremony  
Die Zuordnungszereemonie  
La cérémonie de la Répartition  
Cerimonia dello smistamento  
La Ceremonia de Selección  
A Cerimónia de Seleção  
A beosztási ceremónia  
Šķirošanas ceremonija  
分院仪式





The Great Hall  
Welcoming Feast

The Great Hall Welcoming Feast  
Empfangsfest in der Großen Halle  
La fête de début d'année dans la Grande Salle  
Banchetto di inizio anno nella Sala Grande  
El banquete de bienvenida en el Gran Comedor  
O Grande Salão Banquete de Início do Ano  
Üdvözlő ünnepség a Nagyteremben  
Sagaidišanas mielasts lielajā zālē  
大礼堂欢迎宴会



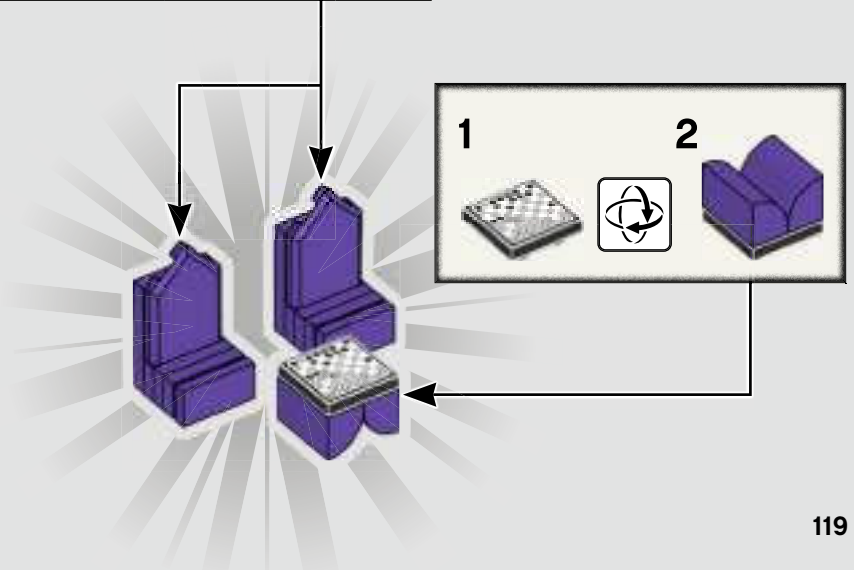
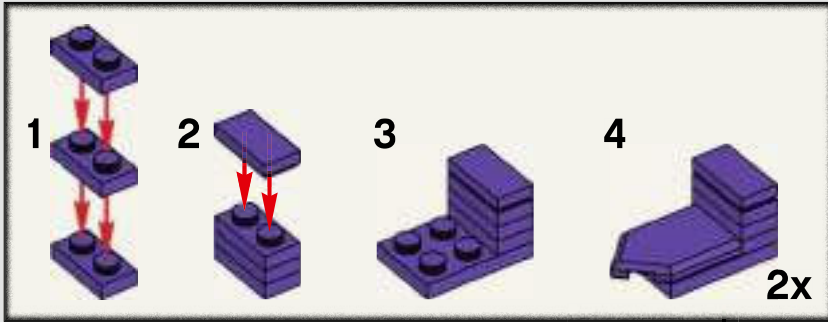
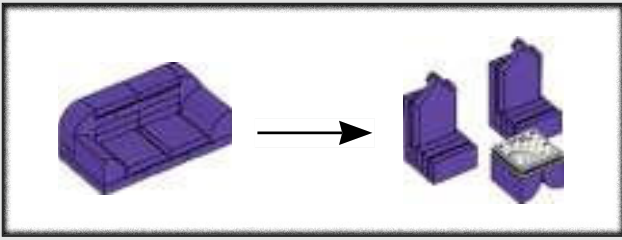

The Common Room

The Common Room  
Der Gemeinschaftsraum  
La salle commune  
La sala comune  
La sala común  
A Sala de Convívio  
A klubhelyiség  
Koptelpa  
公共休息室





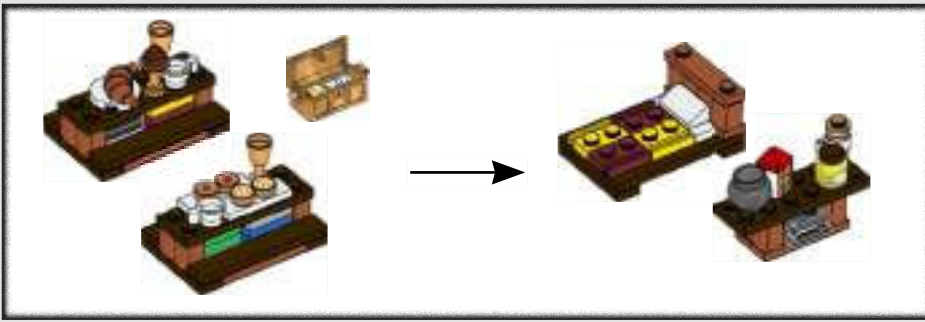

1



2





3



4

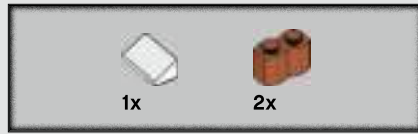

5

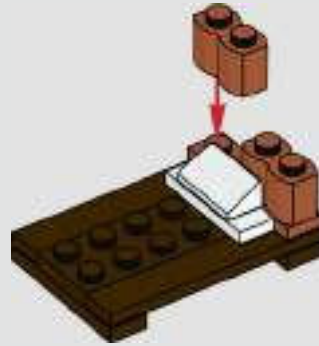

6

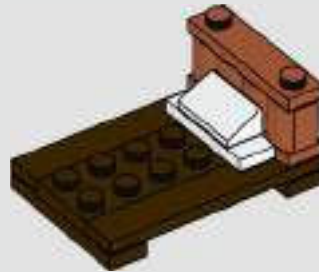

7

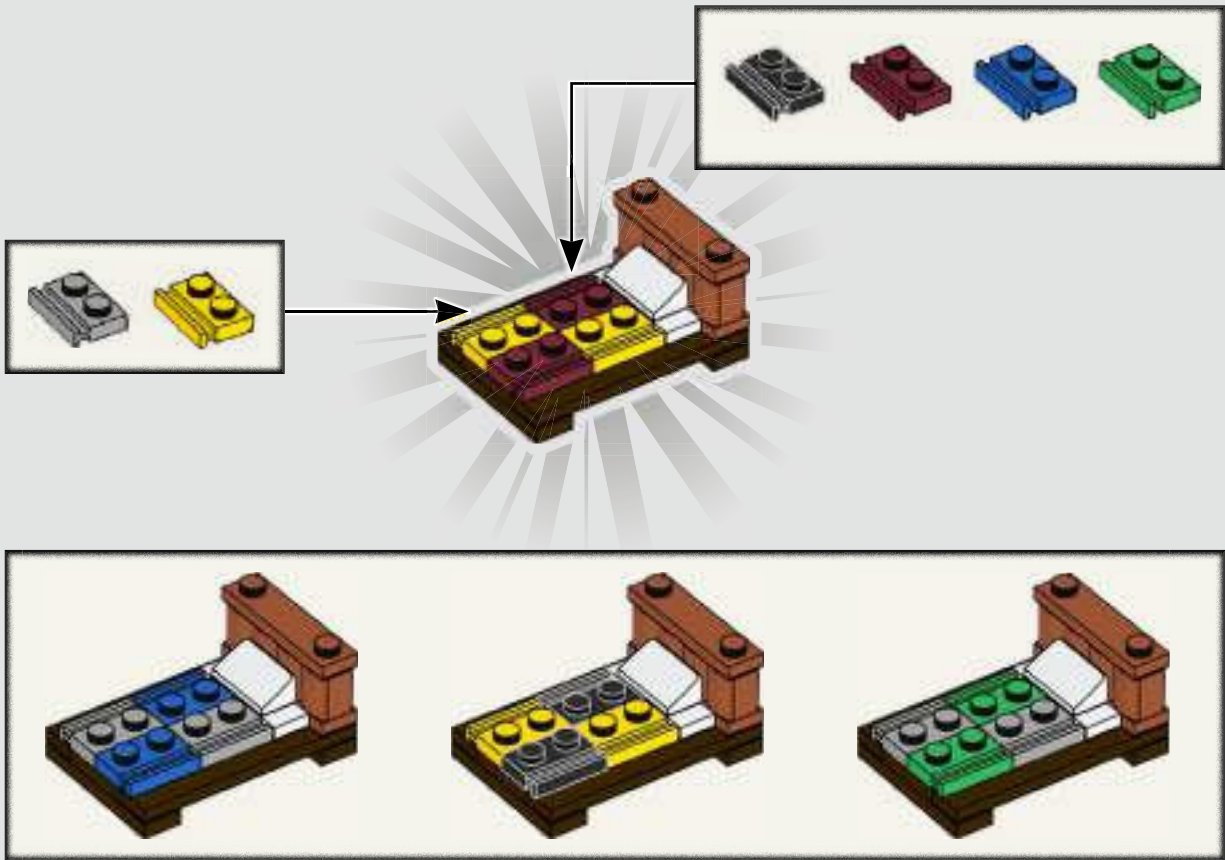



1



2

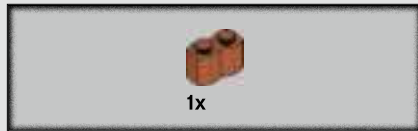
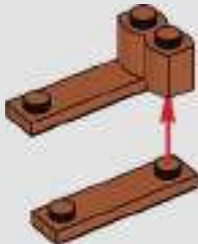

3



4



5

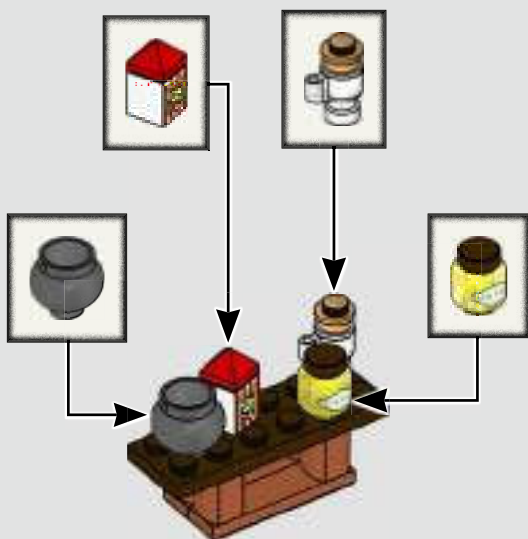

6

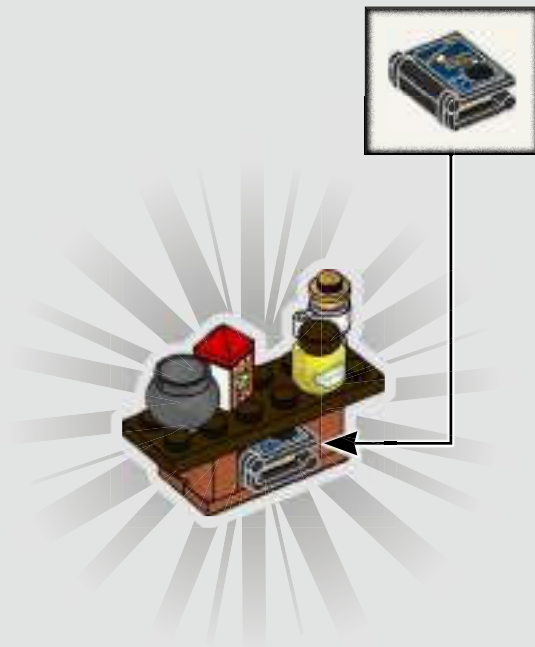

 1x 6365025	 1x 6194444	 18x 4655695	 4x 6231376	 2x 4211414	 1x 6381997	 4x 6025235	 1x 6370527	 3x 6013867
 8x 614121	 8x 614123	 4x 6143993	 6x 4613192	 8x 4211568	 2x 6000311	 4x 6336390	 1x 6233922	 6x 6053077
 3x 6350414	 1x 6358191	 1x 6342521	 6x 6264050	 6x 6102357	 4x 6308045	 8x 6135014	 2x 4278359	 4x 6133722
 4x 306921	 2x 306923	 6x 6245266	 4x 6168642	 4x 6065824	 2x 6314192	 10x 4211088	 3x 4596914	 1x 6326954
 12x 6105976	 6x 6179330	 6x 4225142	 4x 6235083	 4x 4211815	 8x 4211094	 12x 6019987	 2x 6378773	 1x 6375725
 8x 6078641	 6x 6116786	 6x 4225142	 3x 6381953	 4x 4211412	 8x 4211094	 1x 6231765	 2x 306926	 1x 6375743
 8x 6223655	 4x 6129747	 1x 6174125	 8x 4547489	 8x 6167667	 2x 4234534	 1x 6278155	 8x 302326	 1x 6375740
 19x 6240030	 1x 6329324	 1x 6288690	 2x 6093053	 2x 4540203	 8x 4211807	 12x 4211098	 2x 6372272	 1x 6375740
 3x 6349957	 1x 6331764	 8x 614124	 8x 6195371	 4x 4211488	 4x 6247784	 8x 4210719	 12x 6117973	 1x 6375741
 3x 6350862	 8x 4569058	 4x 306924	 2x 6381954	 2x 6173095	 4x 6102774	 3x 6270027	 8x 6310268	 2x 6375231
 4x 6357747	 2x 306928	 8x 4141630	 2x 366601	 2x 4211435	 2x 6055310	 1x 4526110	 2x 6097072	 6x 4107761
 2x 6323033	 6x 4272665	 12x 6079007	 4x 366601	 2x 4211395	 6x 4211053	 3x 6315573	 2x 6378747	 8x 346026
 4x 6245265	 6x 6116259	 4x 6308099	 2x 303201	 2x 4211542	 8x 4211001	 3x 6283610	 2x 368026	 4x 395826
 1x 6254100	 4x 6374049					 1x 6356861	 2x 368026	 4x 395826

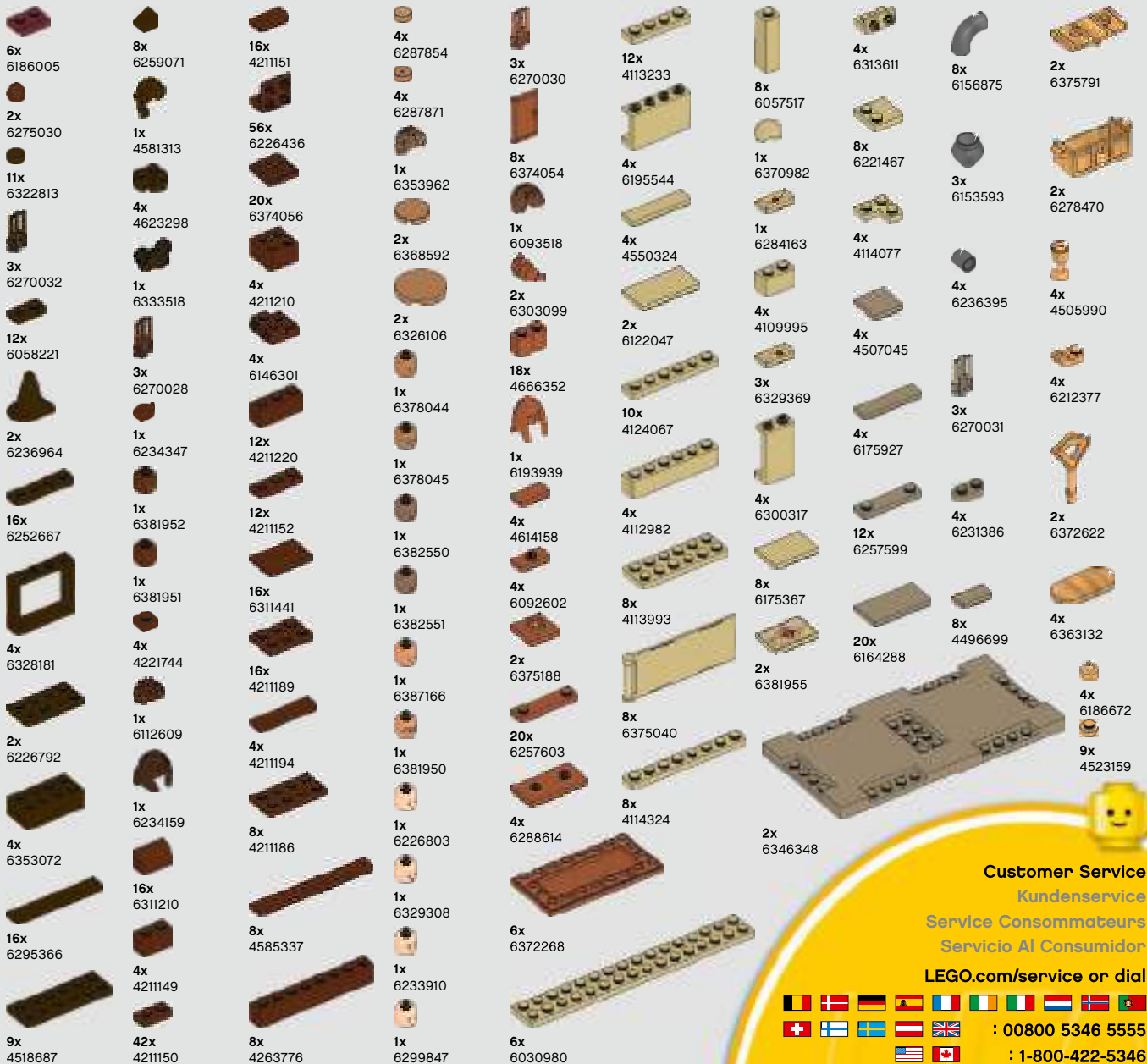

**Customer Service**  
**Kundenservice**  
**Service Consommateurs**  
**Servicio Al Consumidor**  
**LEGO.com/service or dial**

**: 00800 5346 5555**  
**: 1-800-422-5346**

# WIN

GO TO [WWW.LEGO.COM/PRODUCTFEEDBACK](http://WWW.LEGO.COM/PRODUCTFEEDBACK) AND  
GIVE US YOUR SHORT **FEEDBACK** ABOUT THIS  
LEGO® SET FOR A CHANCE TO WIN  
A COOL LEGO PRIZE.

Terms & Conditions apply



## [LEGO.com/productfeedback](http://LEGO.com/productfeedback)

### GEWINNE

Erzähle uns auf  
[www.LEGO.com/productfeedback](http://www.LEGO.com/productfeedback)

etwas über die Erfahrungen, die du mit  
diesem LEGO® Set gemacht hast, und  
sichere dir die Chance auf einen coolen  
LEGO Preis!

Es gelten die Teilnahmebedingungen

### GAGNE

Rends-toi sur  
[www.LEGO.com/productfeedback](http://www.LEGO.com/productfeedback)

et donne-nous quelques commentaires  
sur ce produit LEGO® pour avoir une  
chance de gagner un prix LEGO !

Voir Conditions Générales

### GANA

Visita  
[www.LEGO.com/productfeedback](http://www.LEGO.com/productfeedback)

y envíanos tu opinión acerca de este  
set LEGO®. ¡Participarás en el sorteo de  
un premio LEGO!

Términos y Condiciones aplicables

### 获取奖品

登录  
[www.LEGO.com/productfeedback](http://www.LEGO.com/productfeedback)

给出关于此乐高®套装的简短反馈，  
就有机会获得炫酷乐高奖品

《条款及条件》适用