

QUICK START

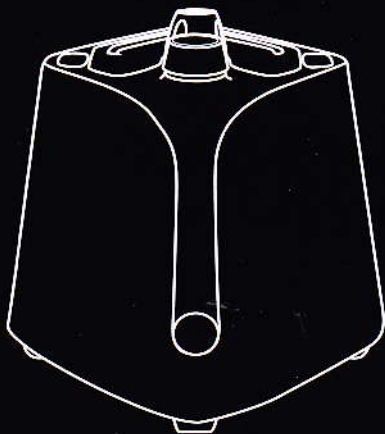

SteamOne

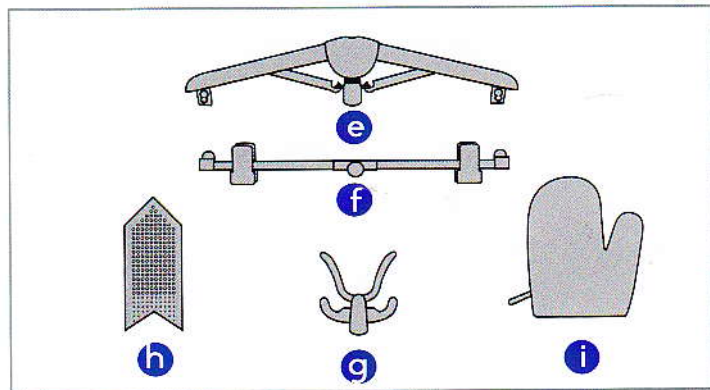
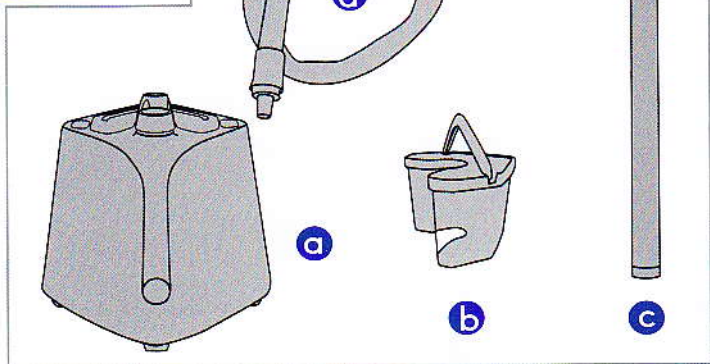

SteamOne

1

e + f

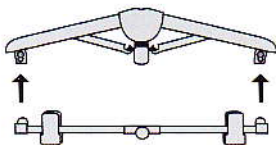

2

a + c



1

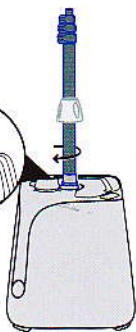
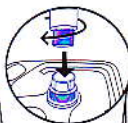

2

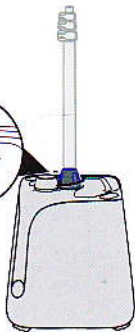
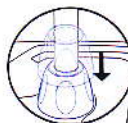

3

SteamOne

3

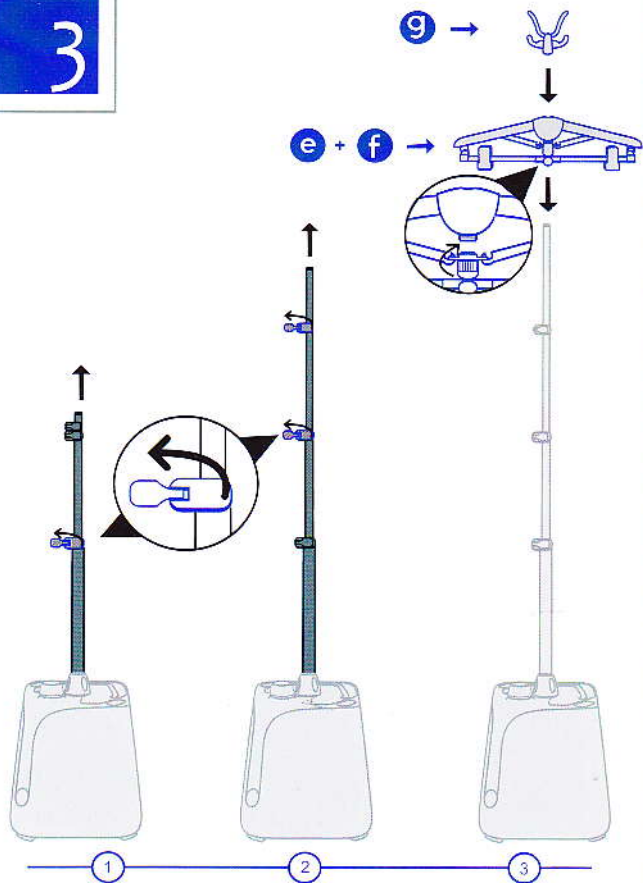

SteamOne

4

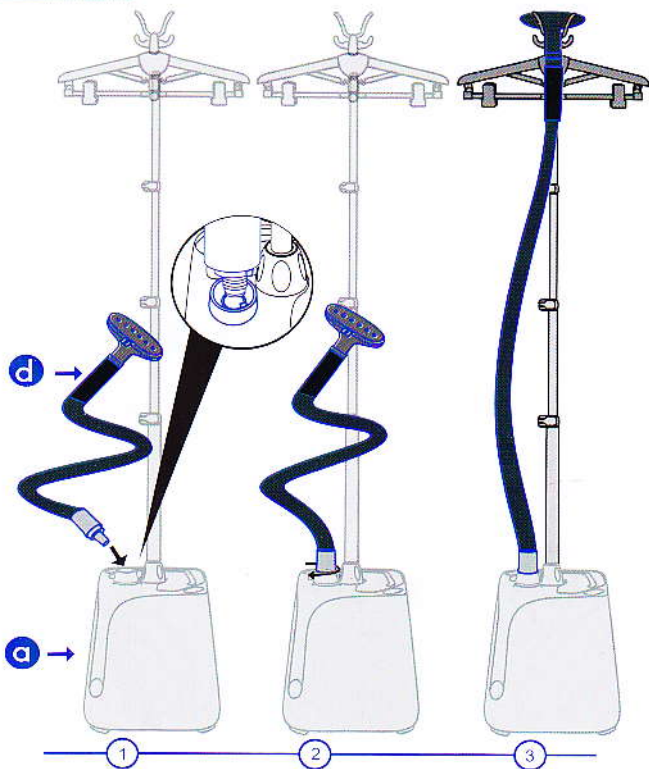

SteamOne

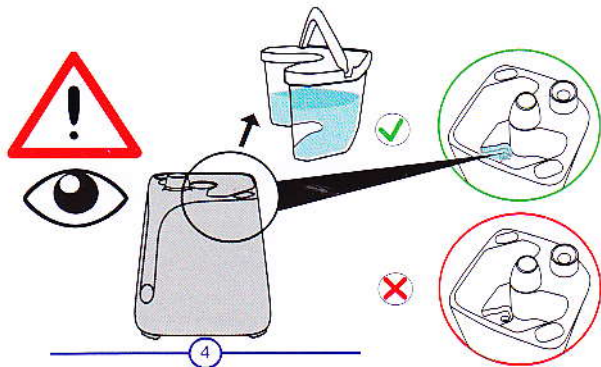
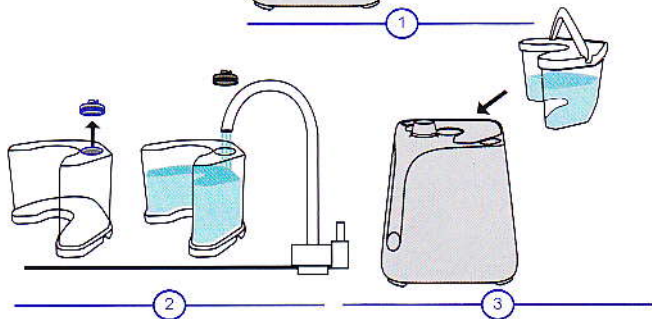
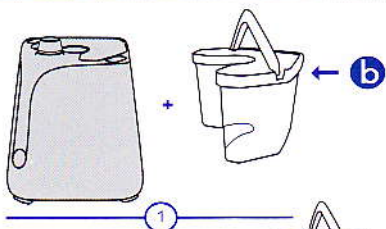

SteamOne

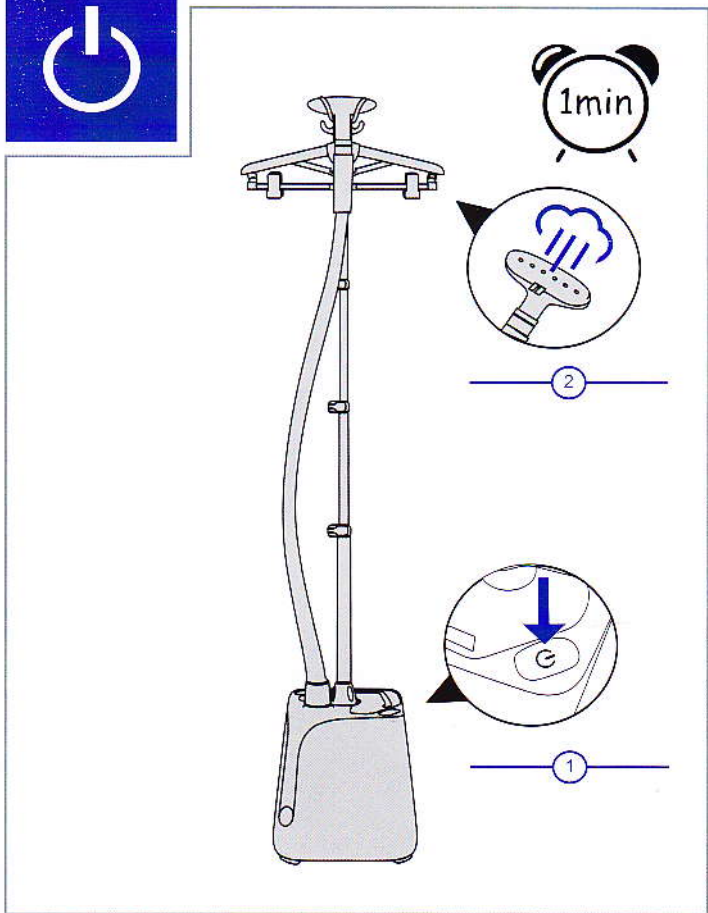

SteamOne



e

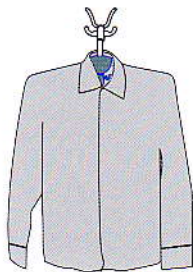

g

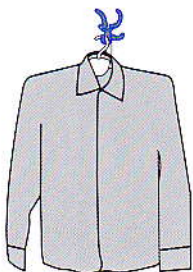

e + f

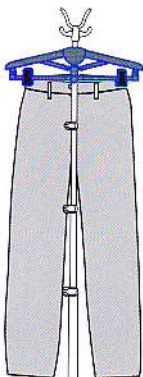

SteamOne

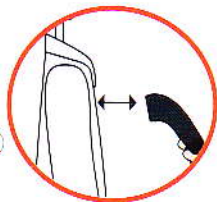

1



2

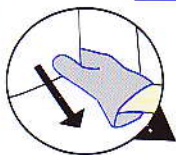

3

SteamOne

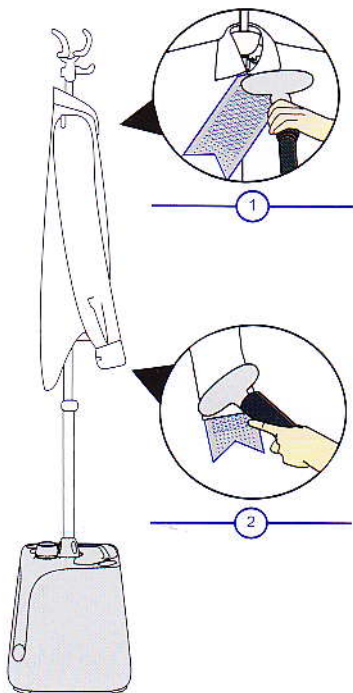

SteamOne

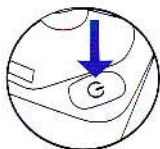

OFF

0

a →

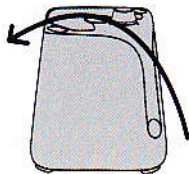

1

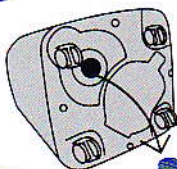
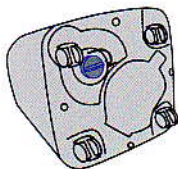

2

b ↓

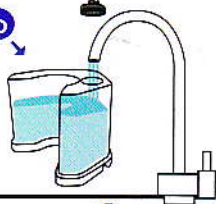

3

SteamOne

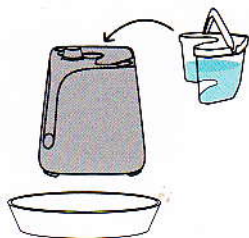

4

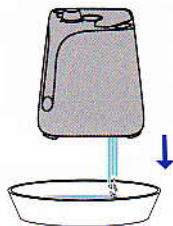

5

