



# SONIC™

THE HEDGEHOG

76994





[LEGO.com/sustainable-packaging](https://LEGO.com/sustainable-packaging)





# BUILDER



Apple and the Apple logo are trademarks of Apple Inc., registered in the U.S. and other countries and regions. App Store is a service mark of Apple Inc. Google Play and the Google Play logo are trademarks of Google LLC. Tencent and the Tencent logo are trademarks of Tencent Inc.

Q [LEGO.com/devicecheck](https://www.lego.com/devicecheck)

EN Ask parents' permission before going online | DE Eltern um Erlaubnis bitten, bevor du online gehst | FR Demande l'autorisation d'un parent avant d'aller en ligne | IT Chiedi il permesso ai tuoi genitori prima di andare online | ES Pídeles permiso a tus papás antes de conectarte a Internet | PT Peça autorização aos pais antes de acederes online | ZH 上网前应先征得父母的同意 | PL Poproś rodziców o zgodę, zanim wejdiesz do Internetu | CS Než půjdeš na internet, požádej rodiče o svolení | SK Skôr než pôjdeš na internet, vypýtaj si povolenie od rodičov | HU Kérj szülői engedélyt, mielőtt online csatlakoznál! | RO Cere permisiunea părinților înainte de a te conecta online | BG Поискайте разрешение от родител, преди да влезете онлайн | LV Pirms došanās tiešsaistē palūdz atļauju vecākiem | ET Enne Interneti kasutamist küsi vanematelt luba | LT Prieš prisijungdami prie interneto, atsiklauskite tėvų

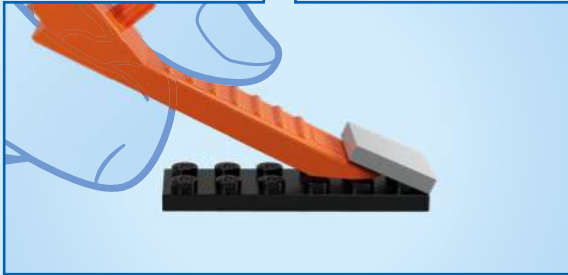
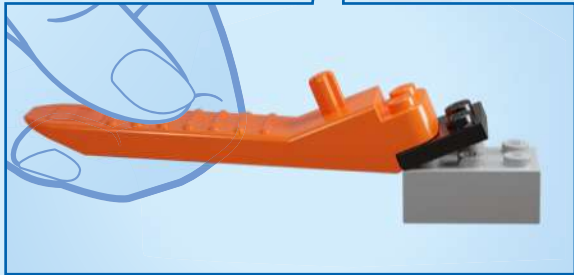
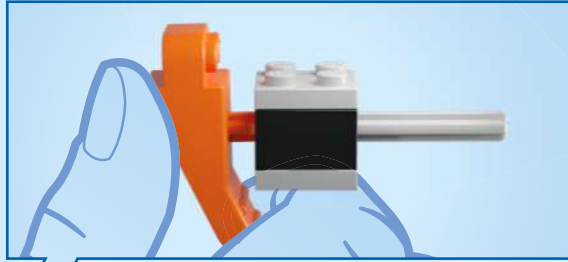
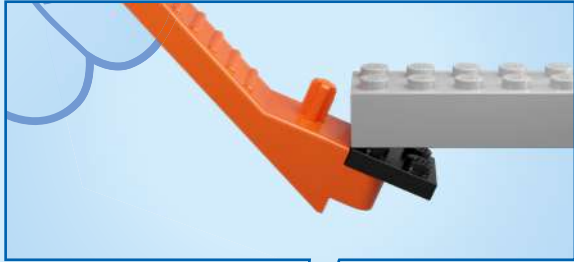



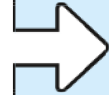
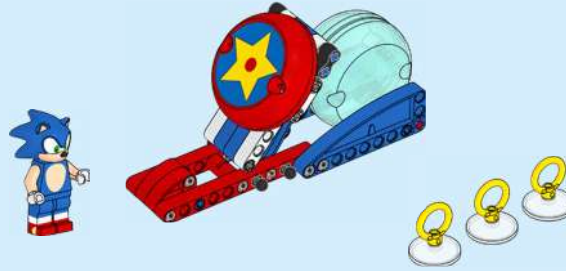
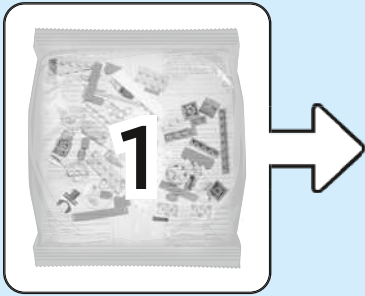

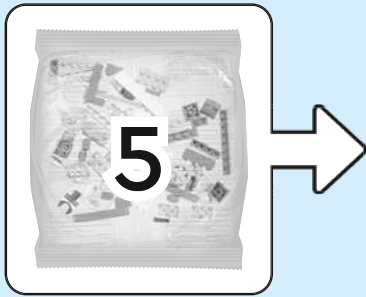

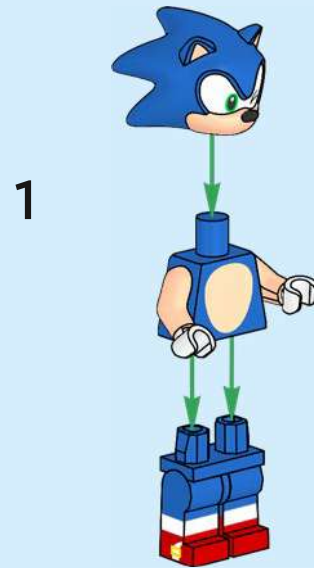

2

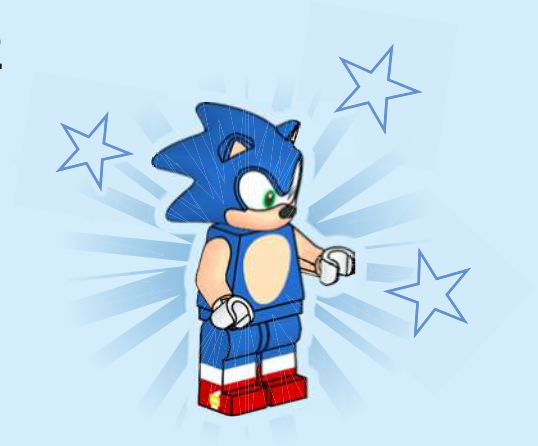



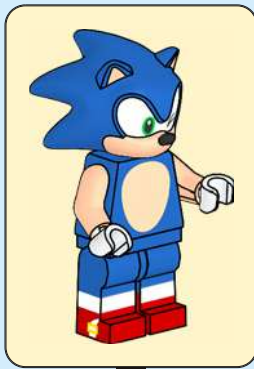
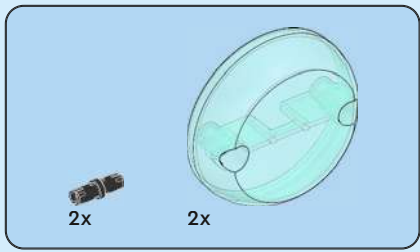

1

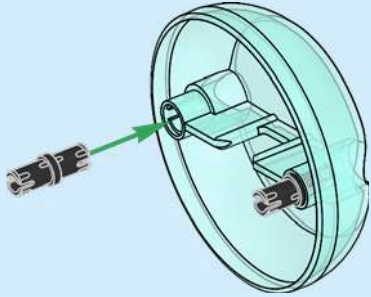

2



3

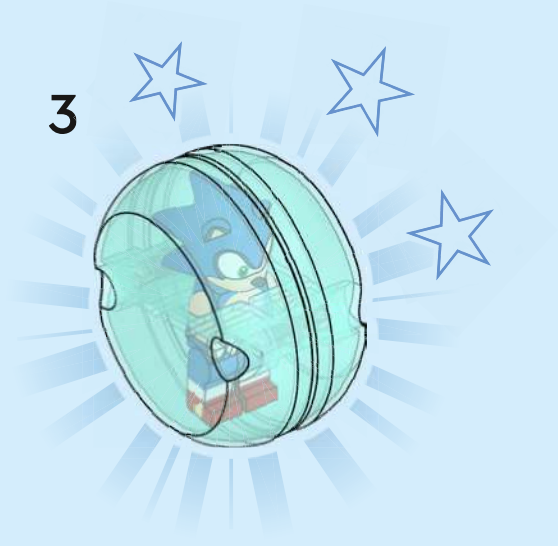

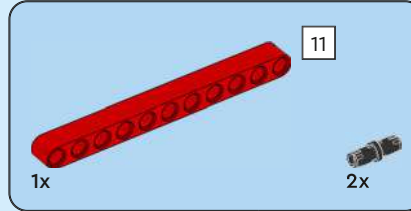
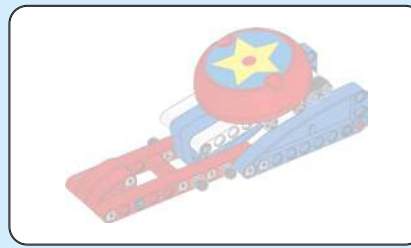
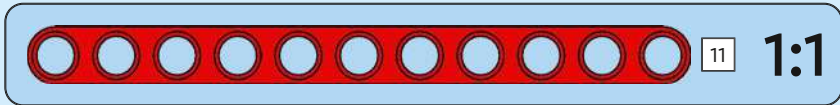
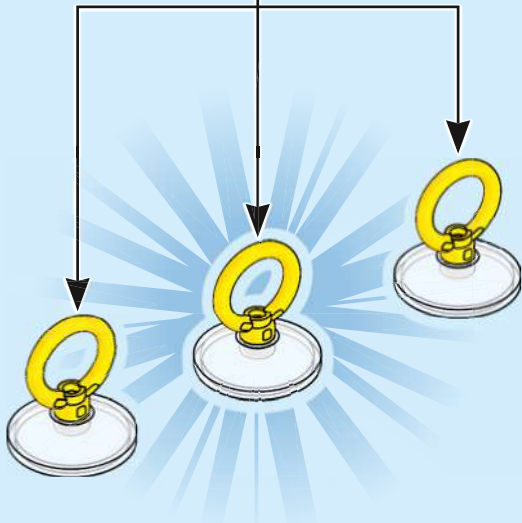
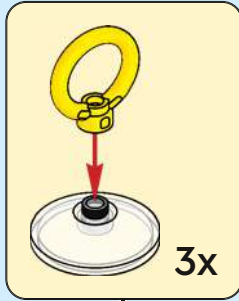

1

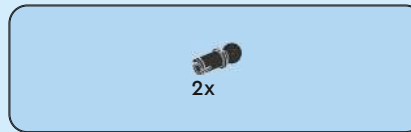
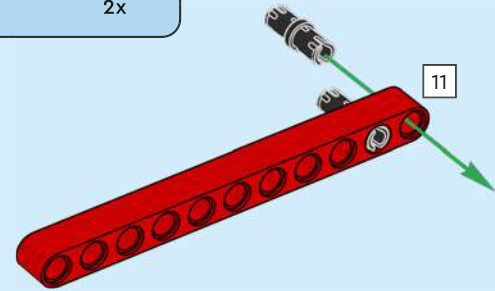

2

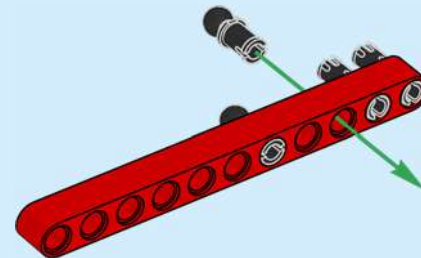

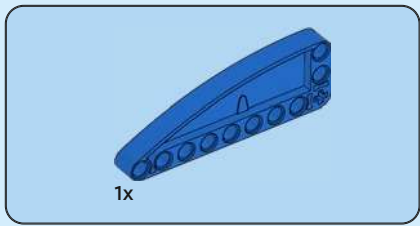

3

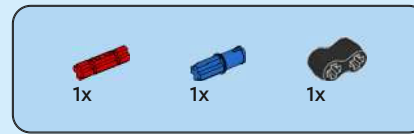
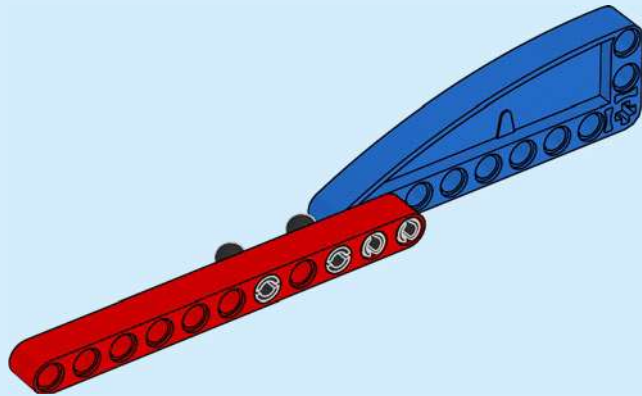

4

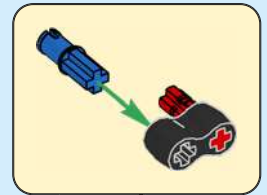
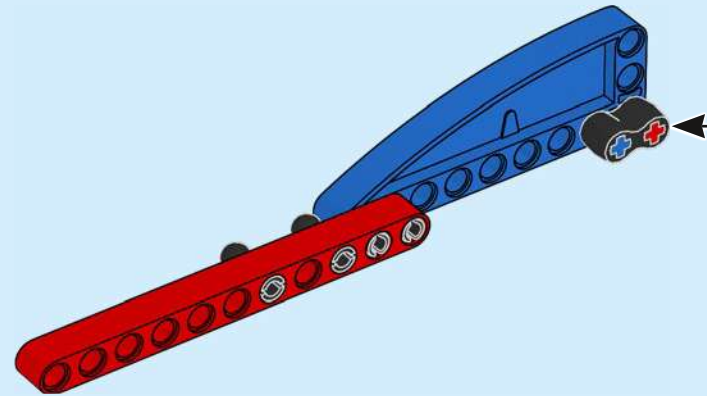





5

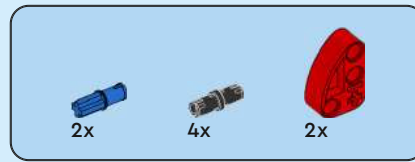
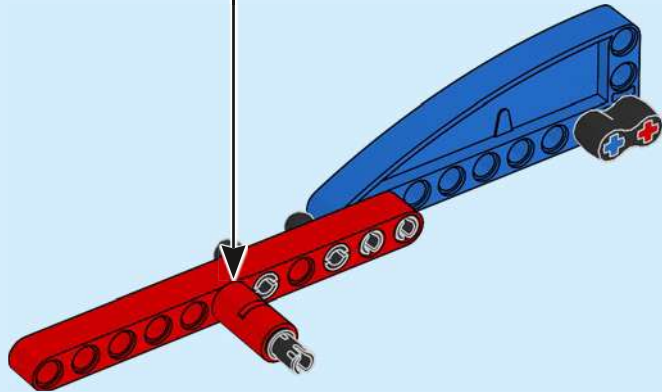
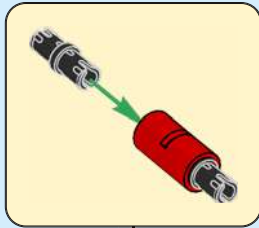

6

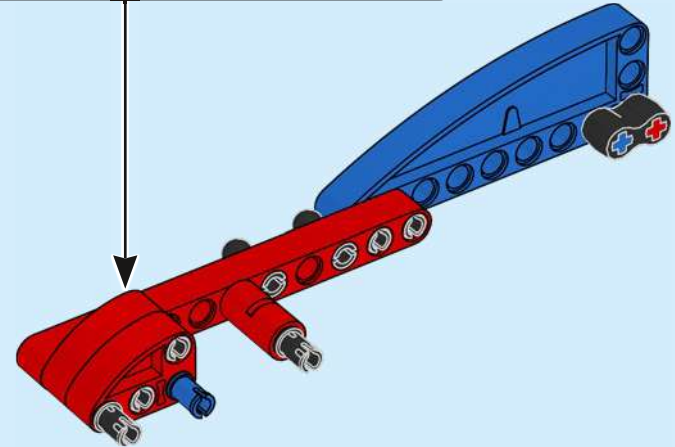
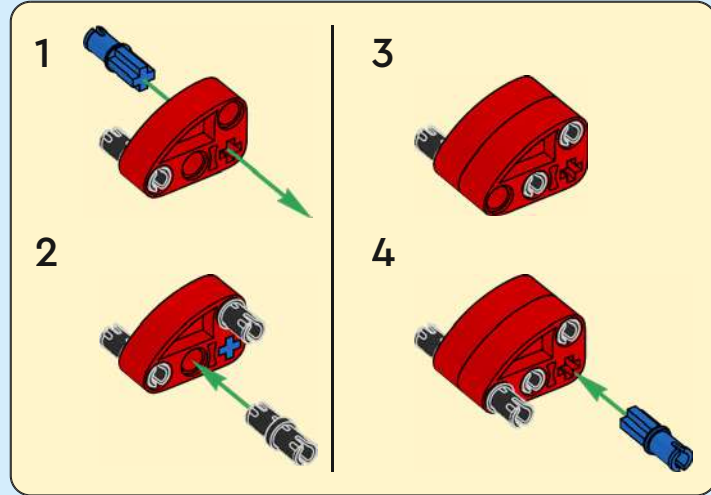

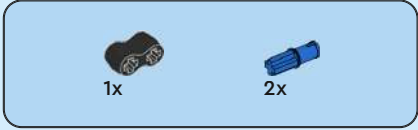

7

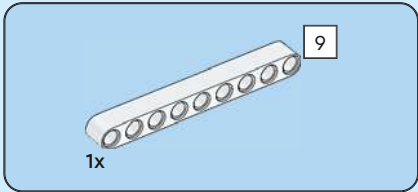
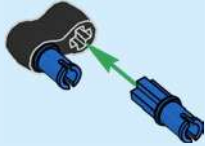

8

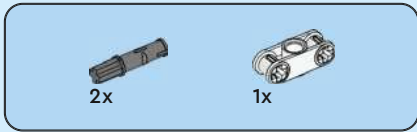

9

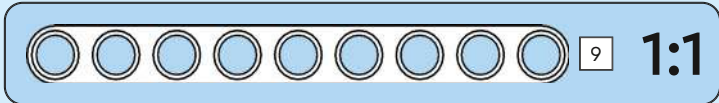
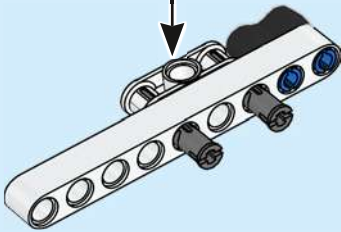
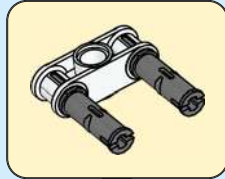

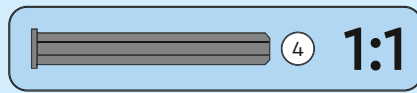
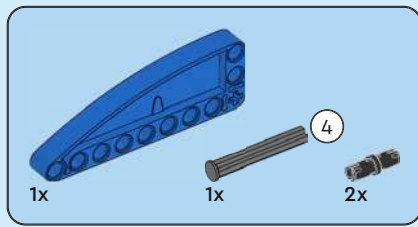

10

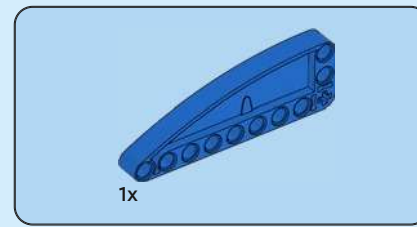
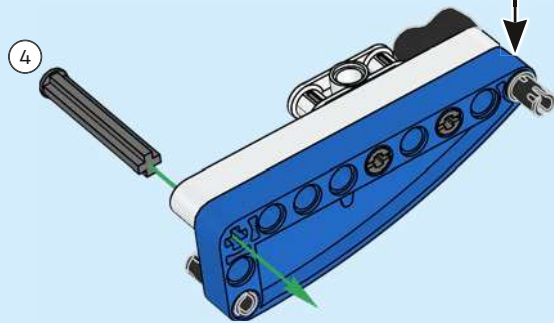
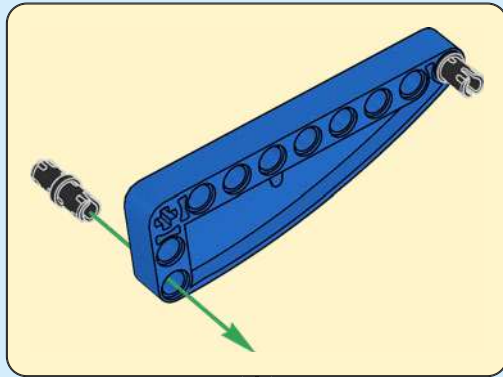

11

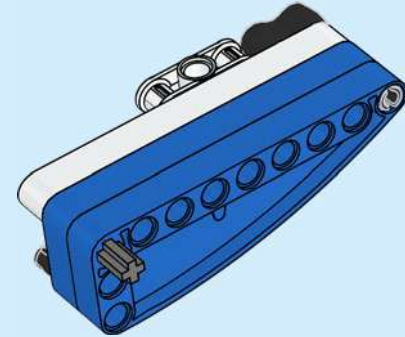

12

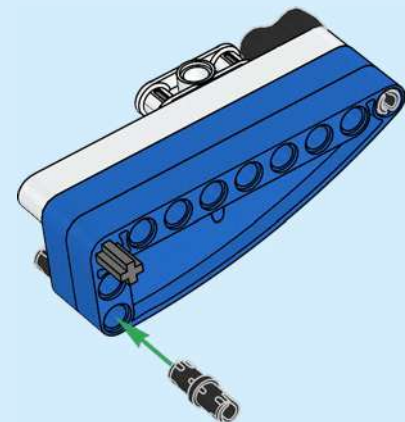



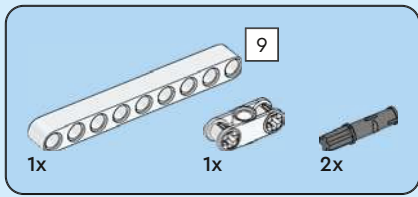

13

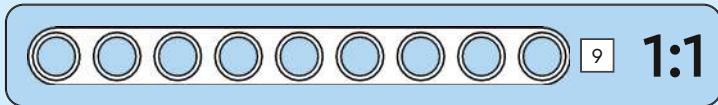
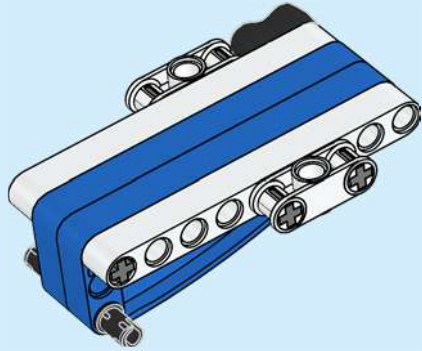
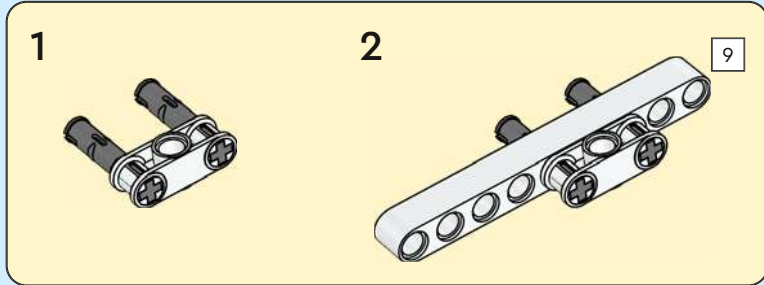

14

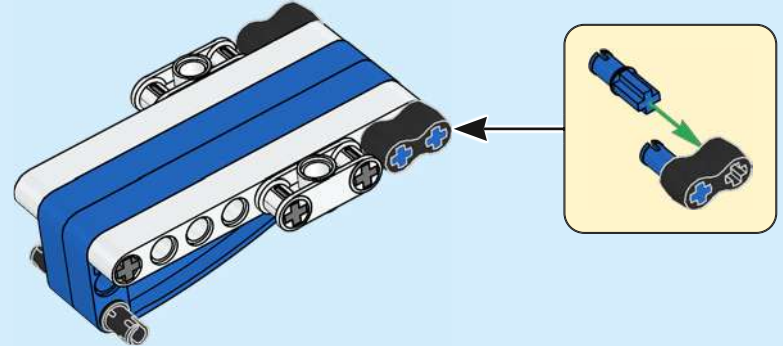

15

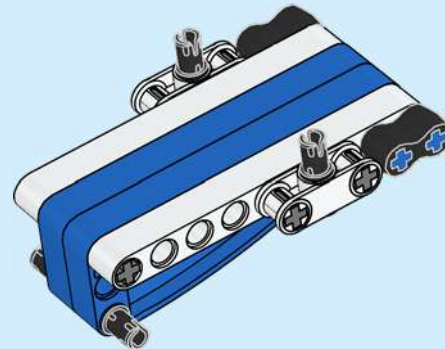

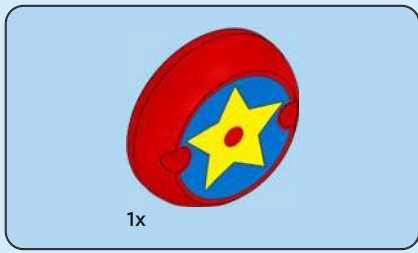

16

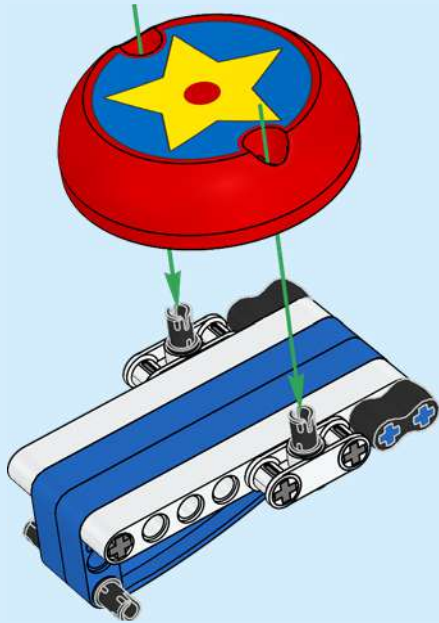

17

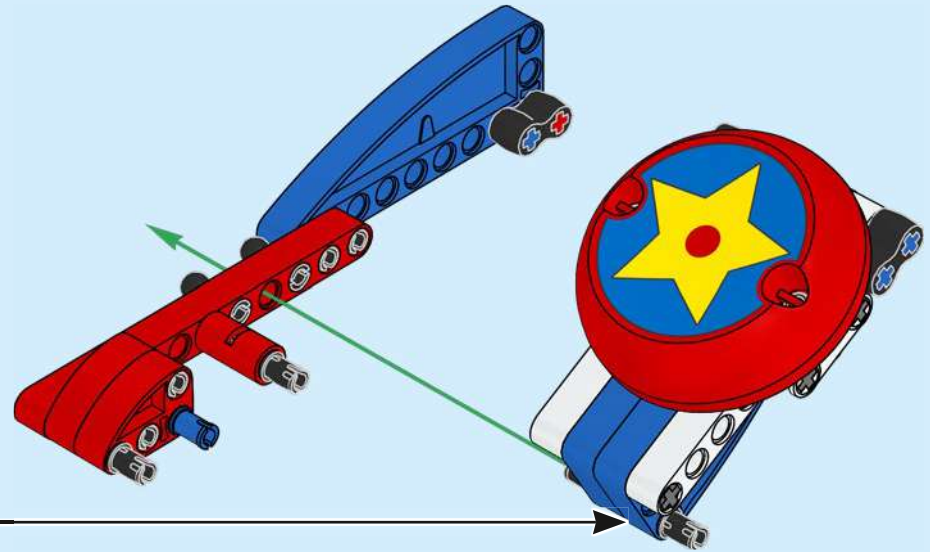

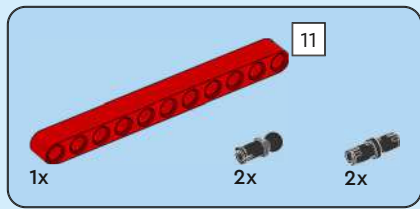

18

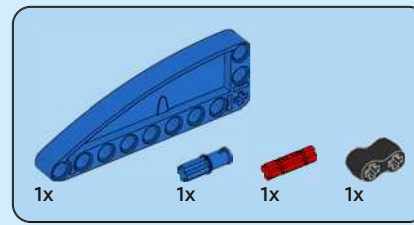
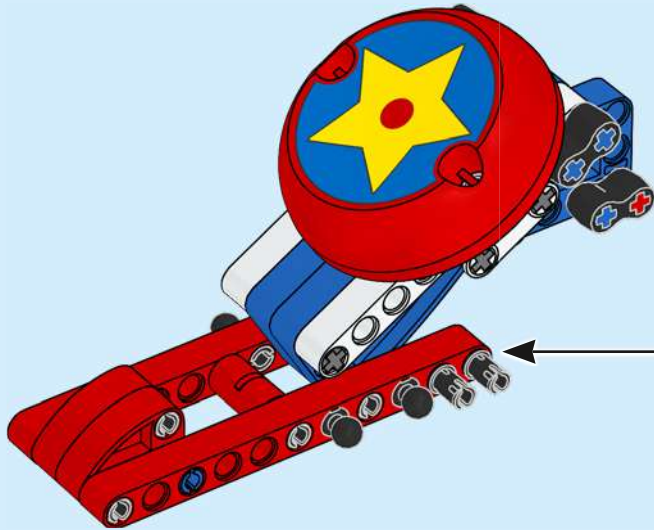
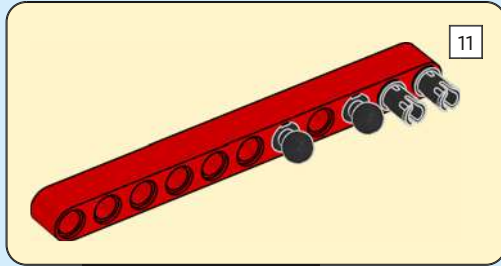

19

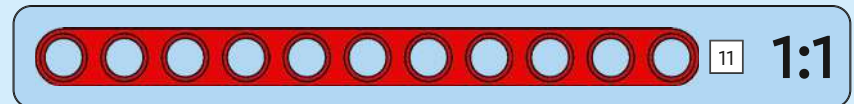
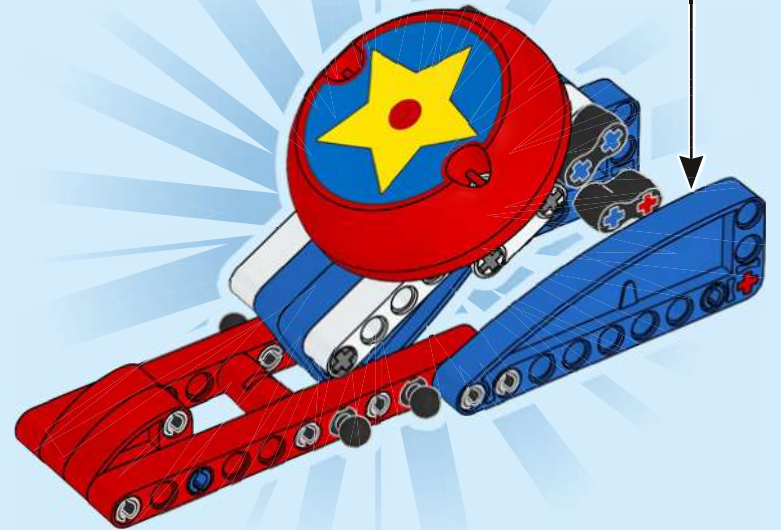
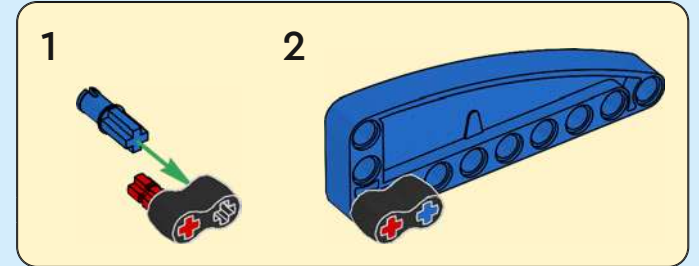

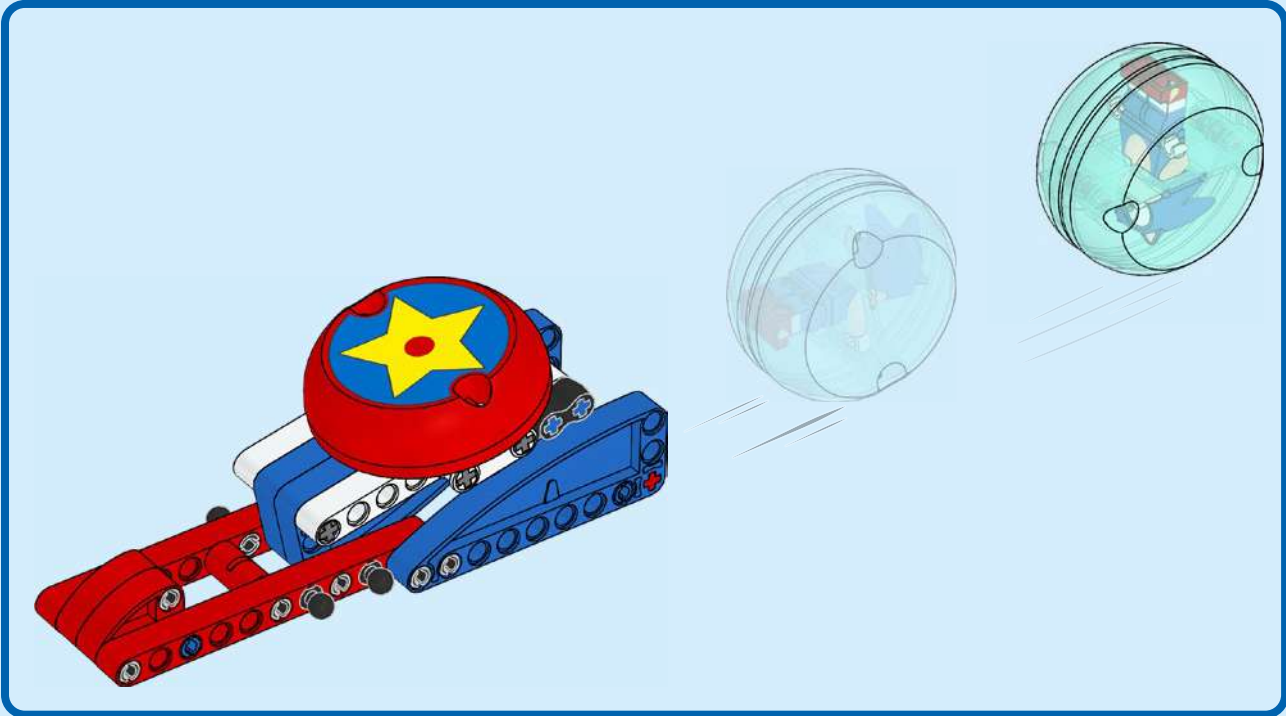
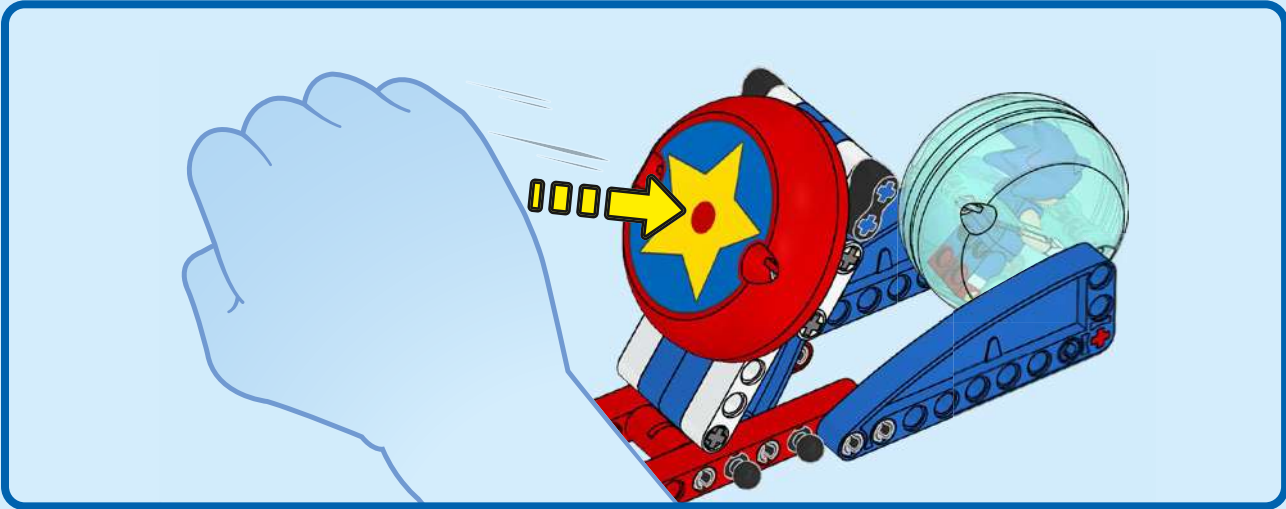



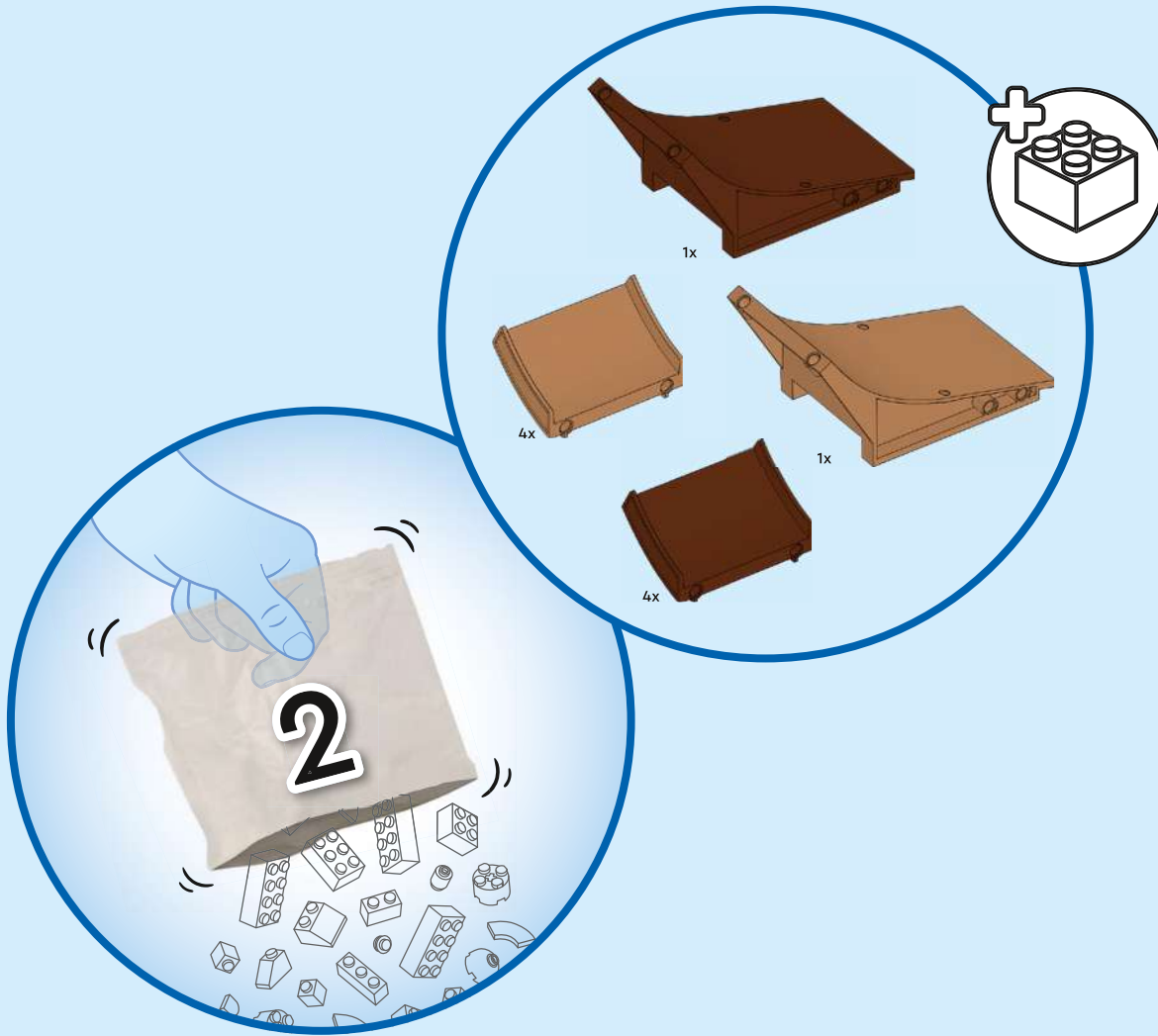

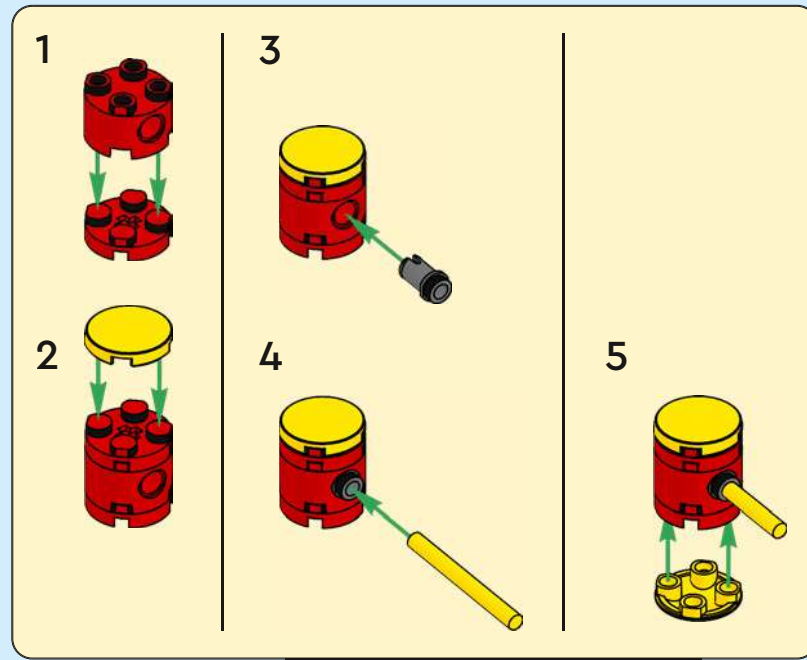
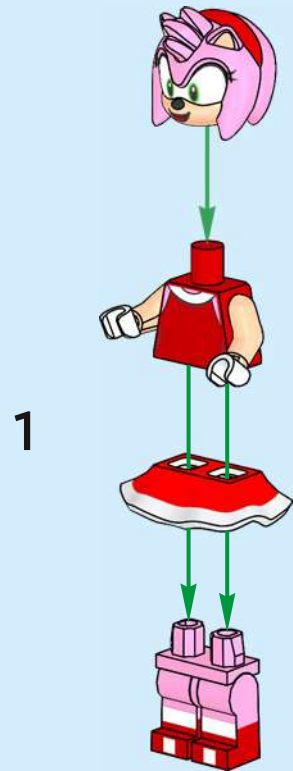
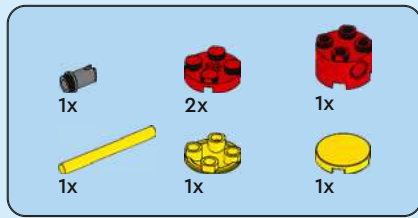

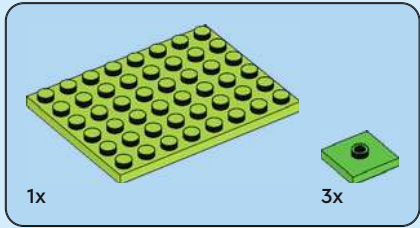
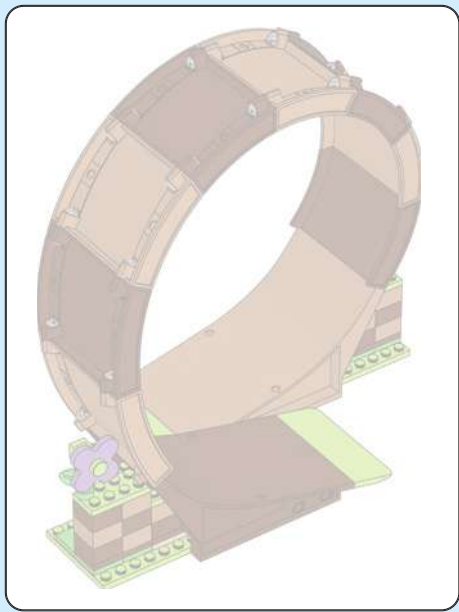

1

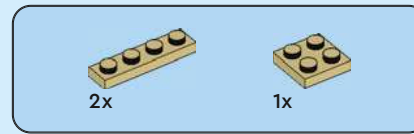
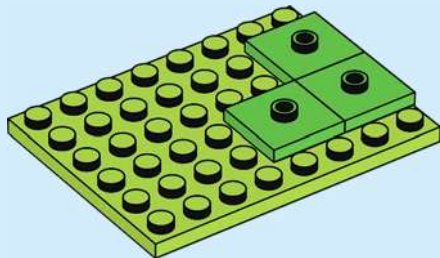

2

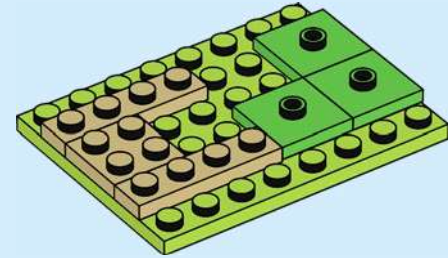

3

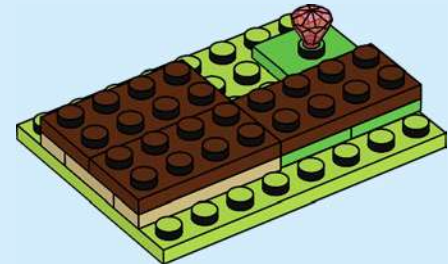

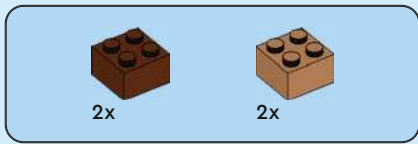

4

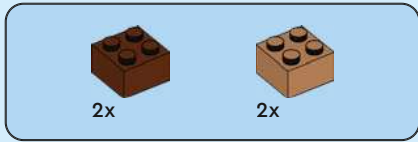
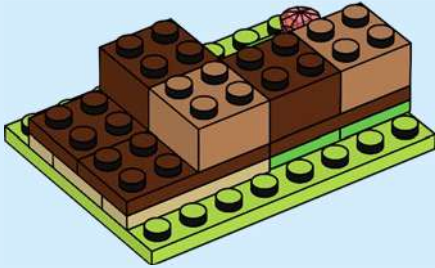

5

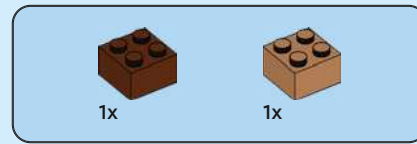
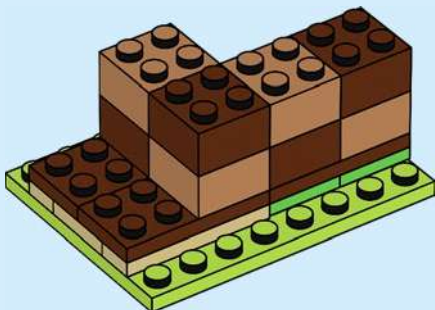

6

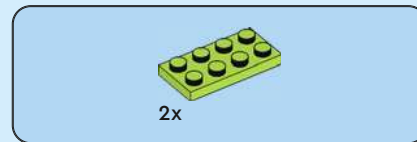
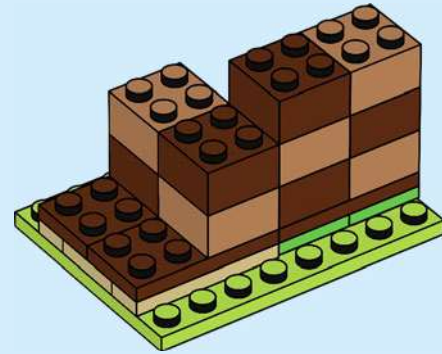

7

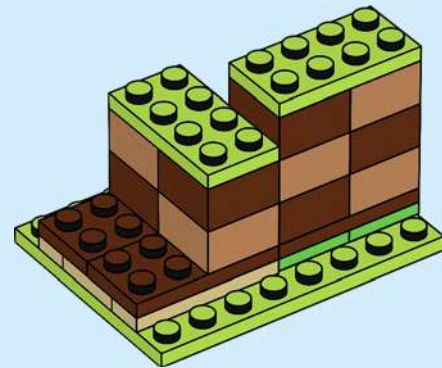



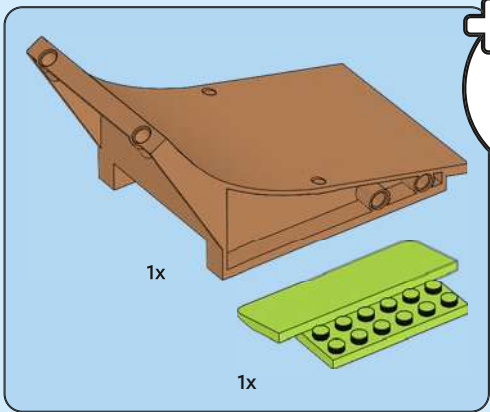
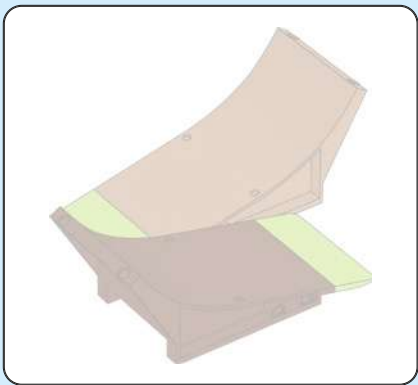

8

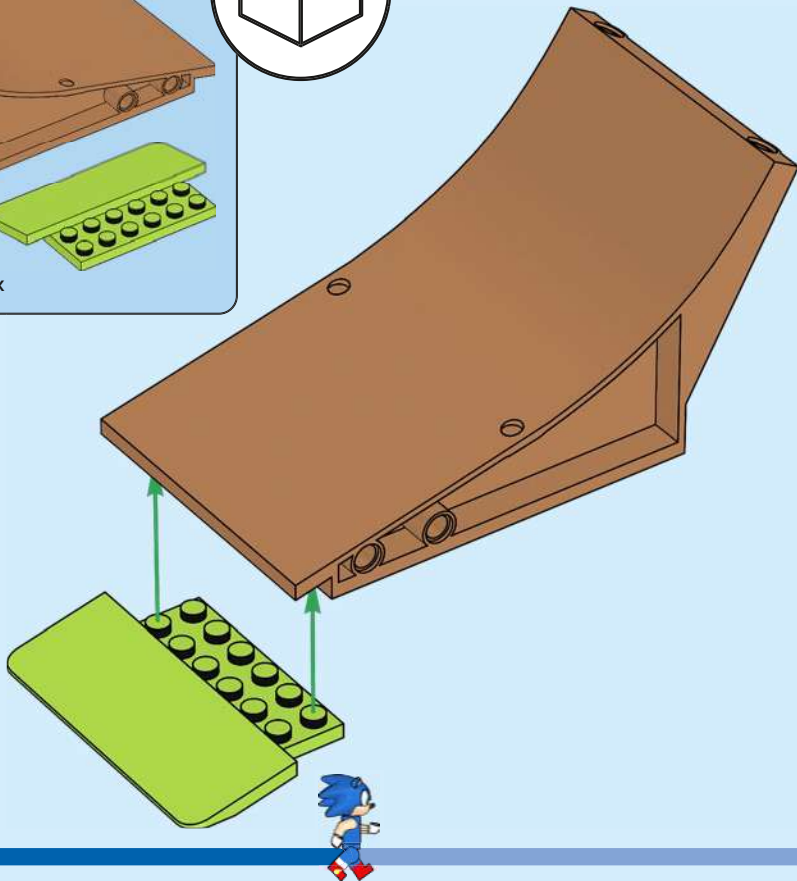

9

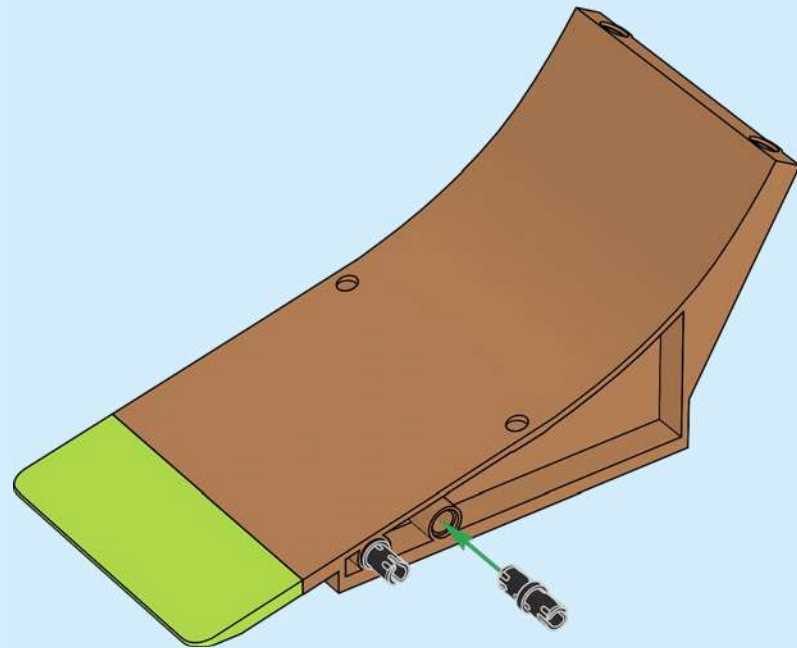

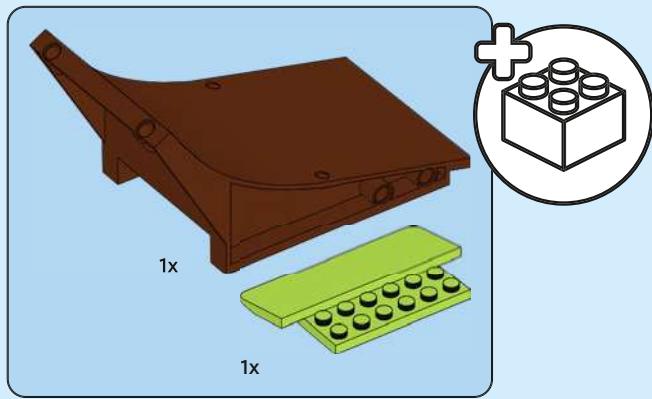

10

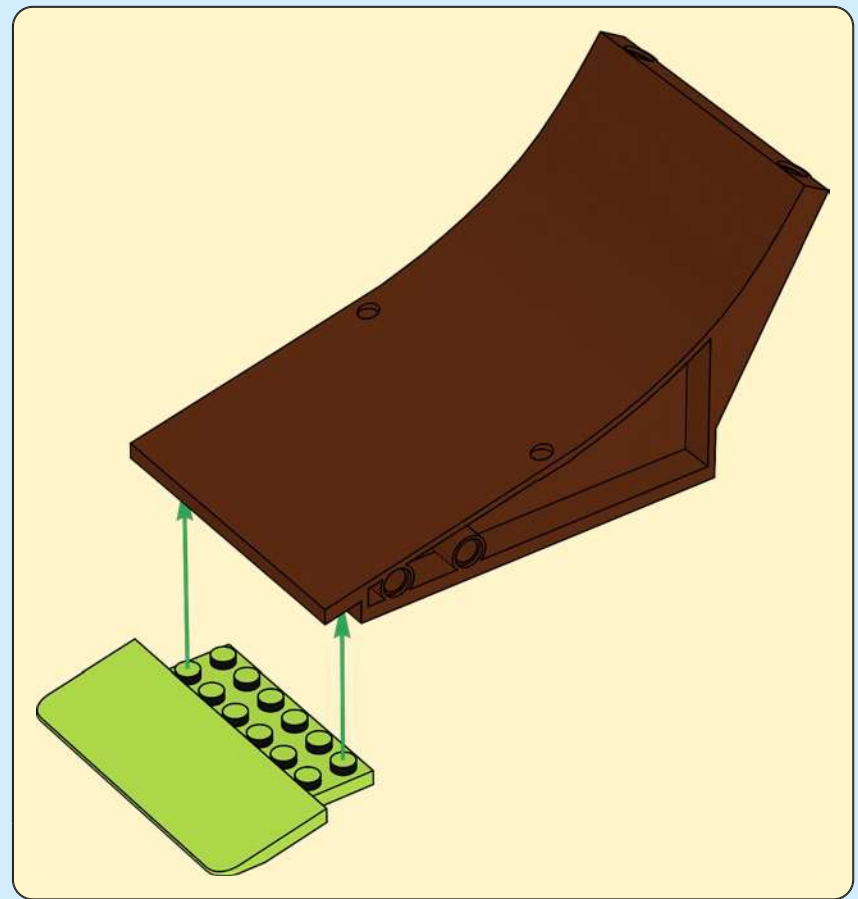
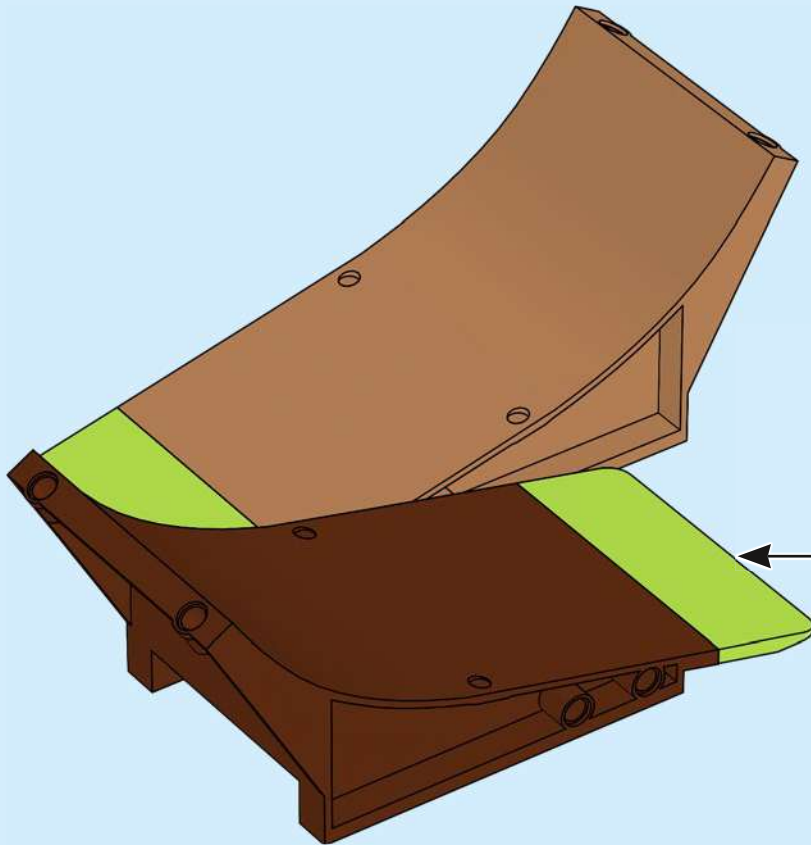

11

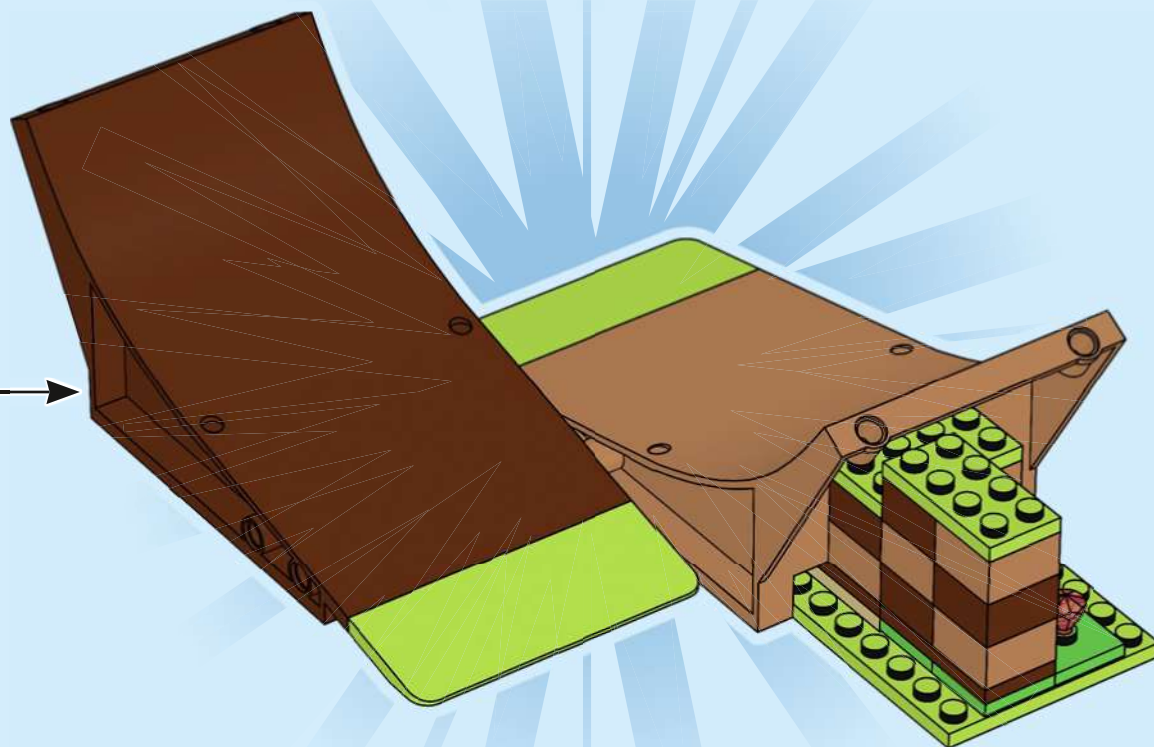

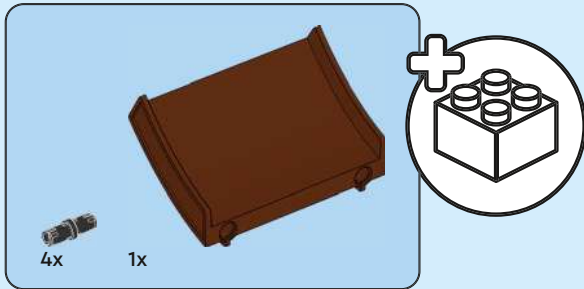
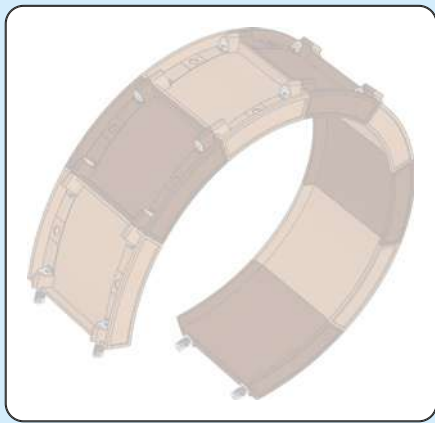

12

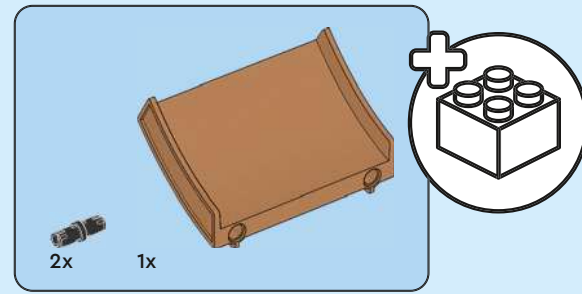
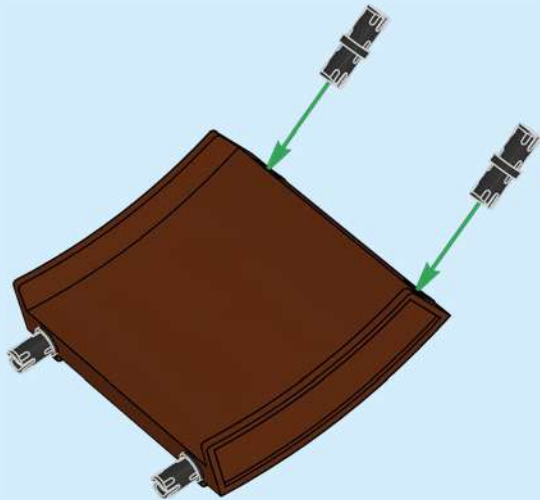

13

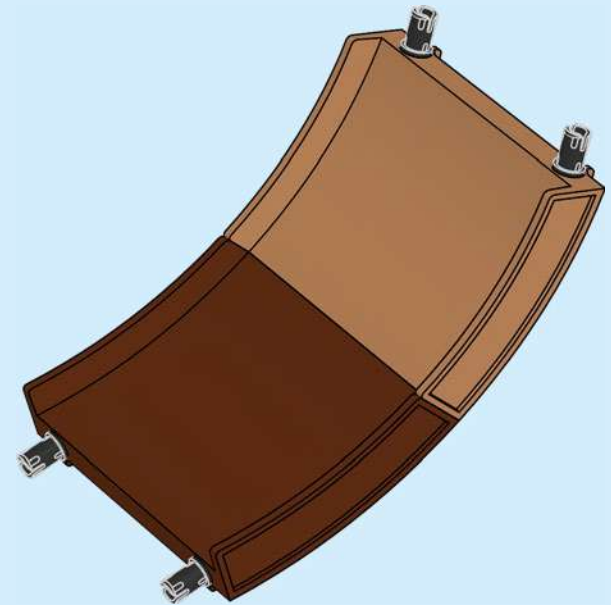



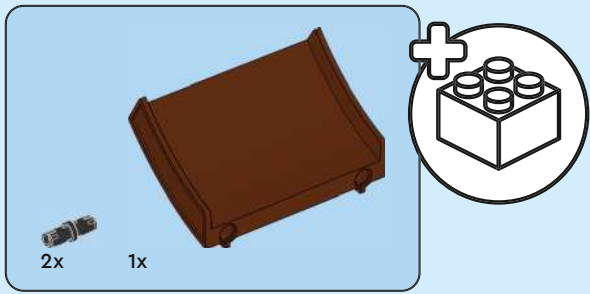

14

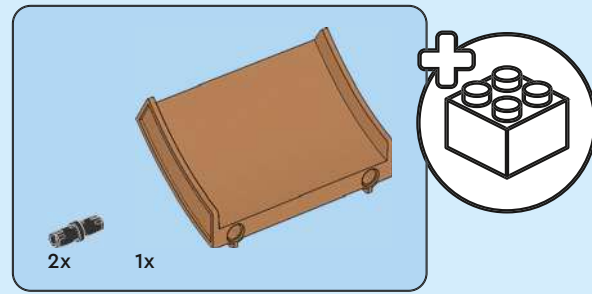
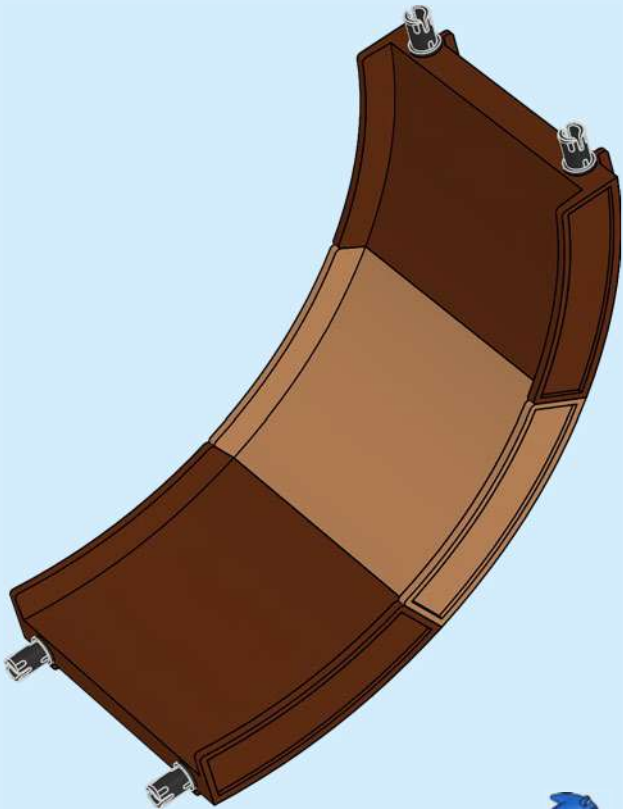

15



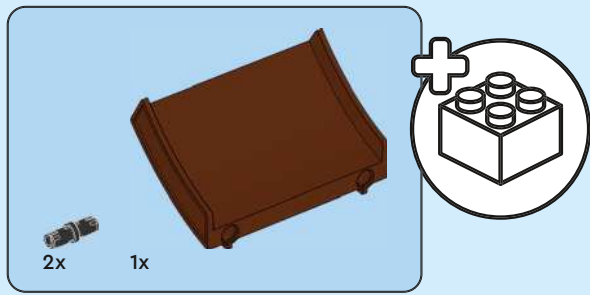

16

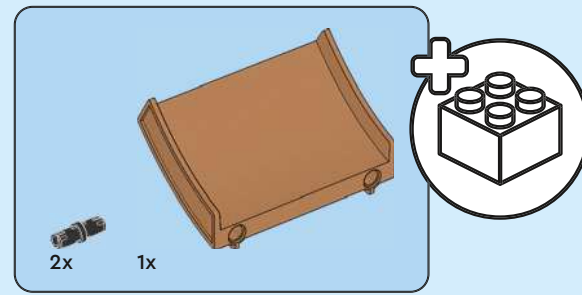
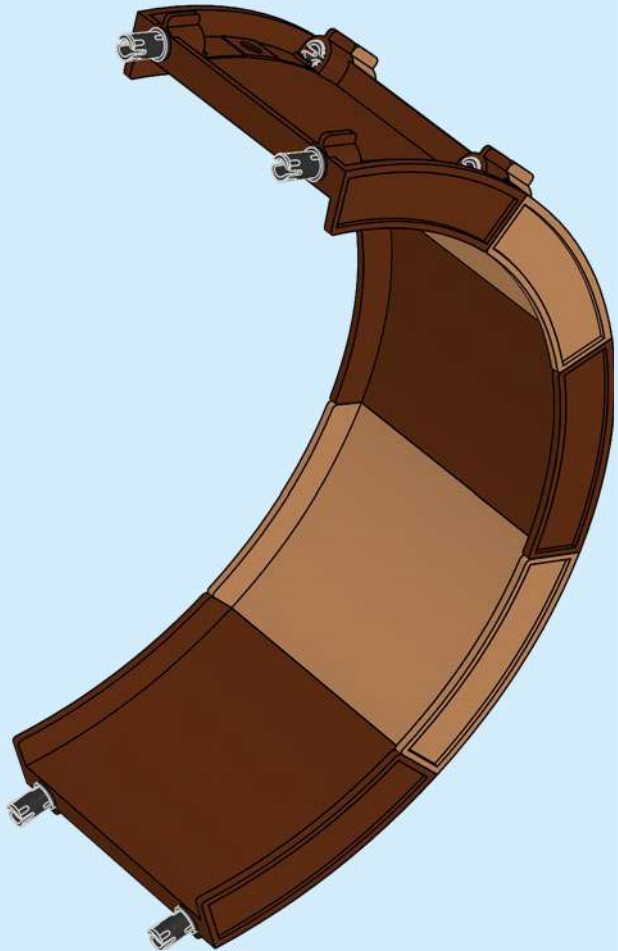

17

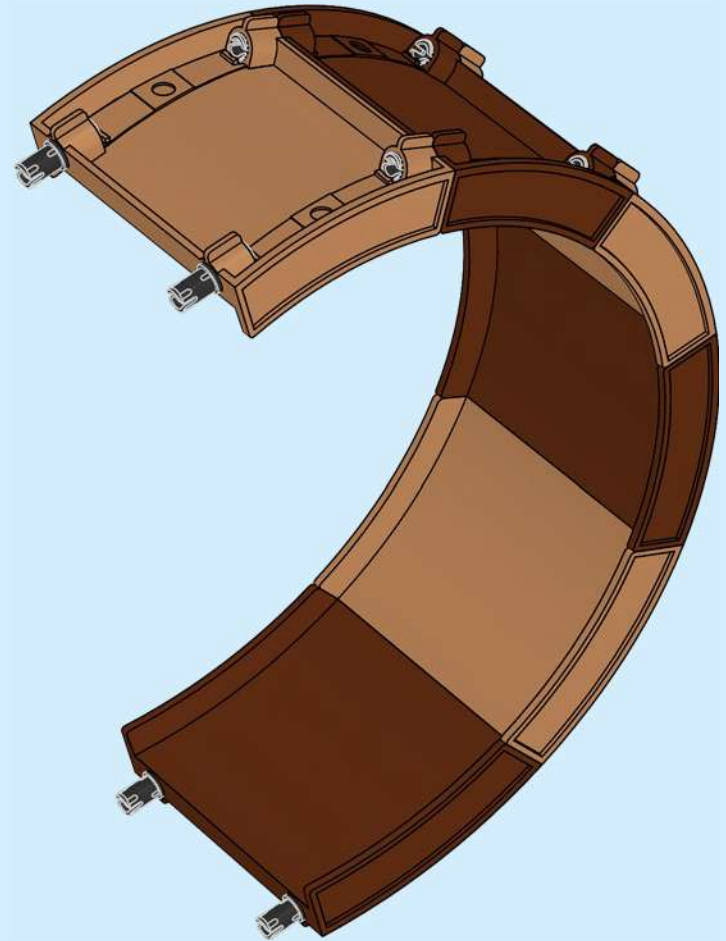

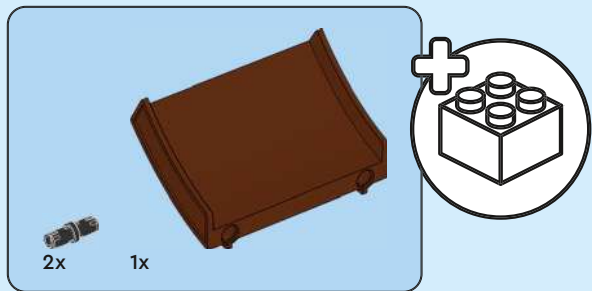

18

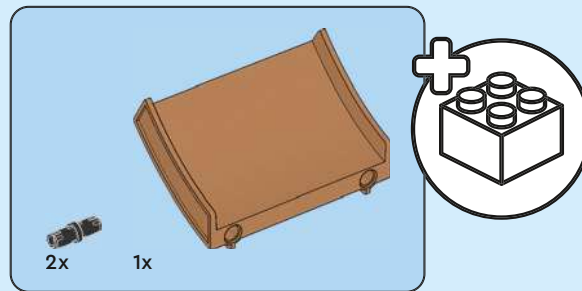

19





20

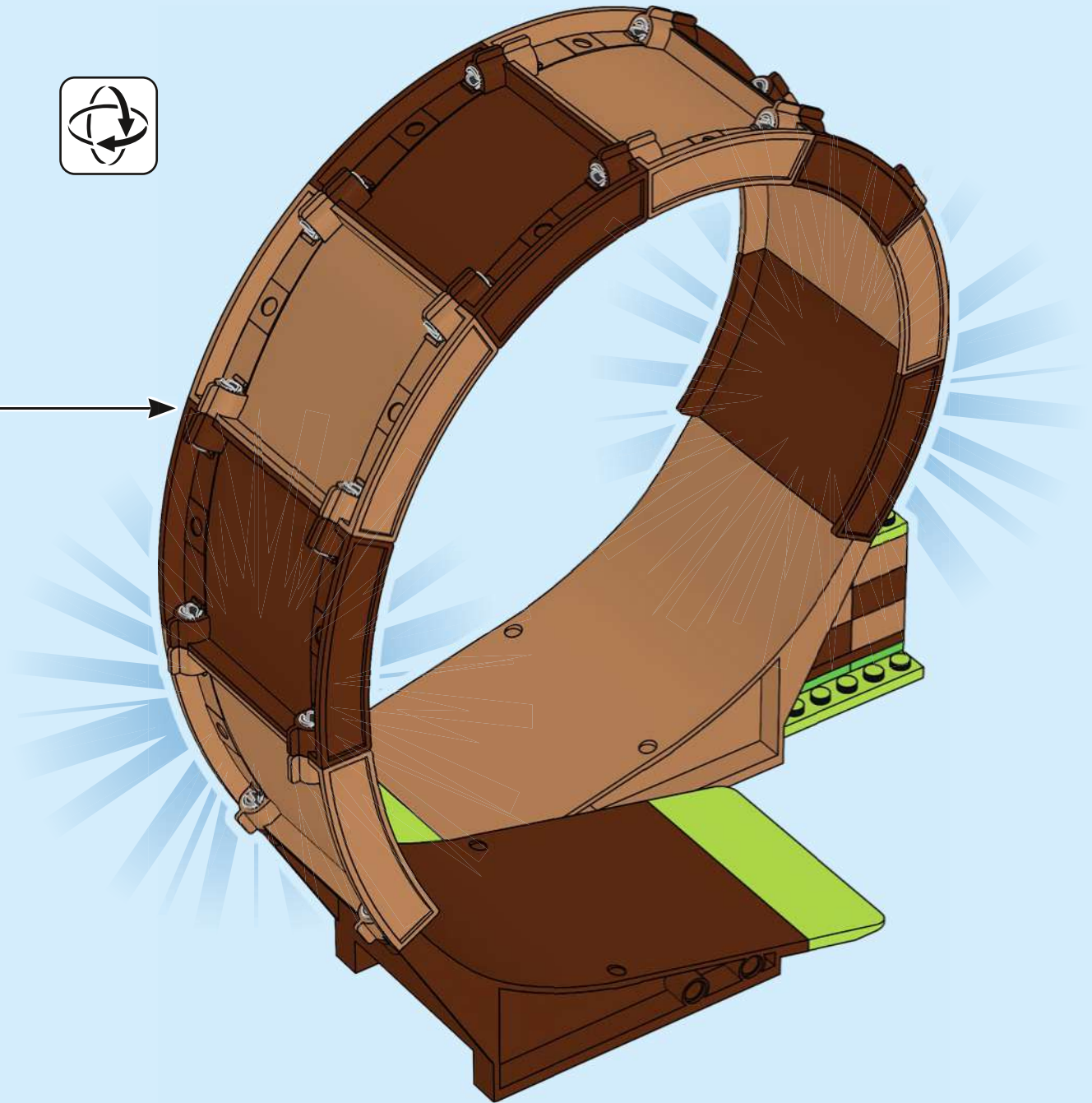



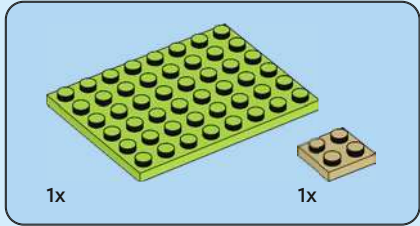
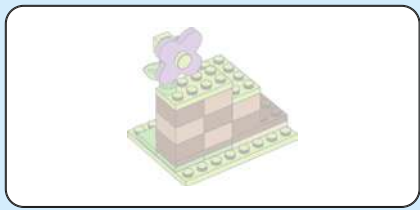

21

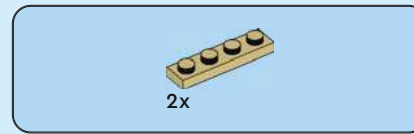
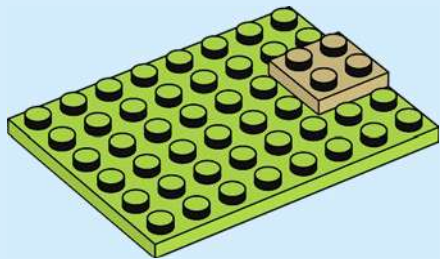

22

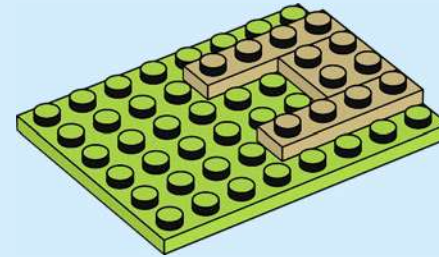

23

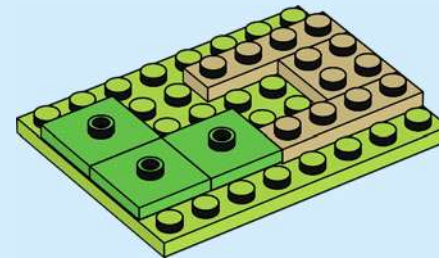



24

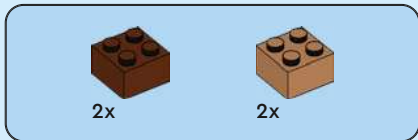
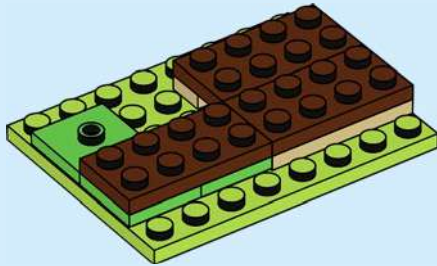

25

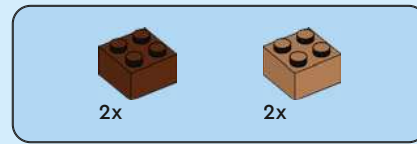
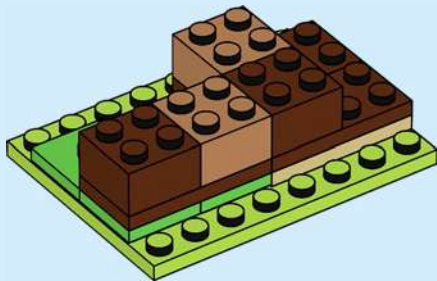

26

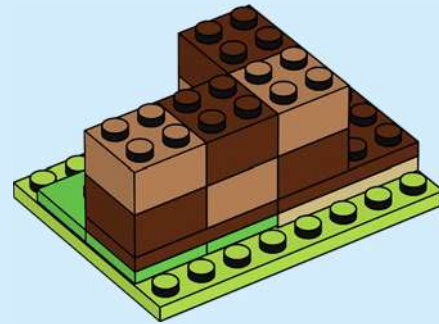

27

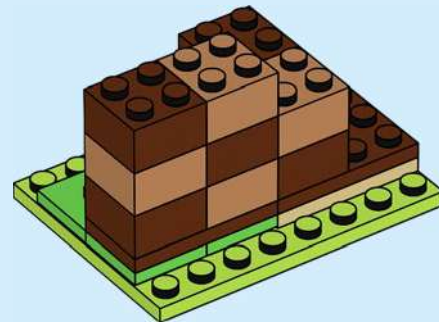

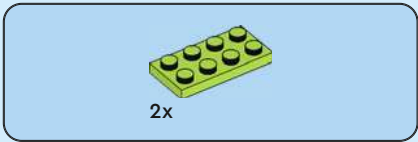

28

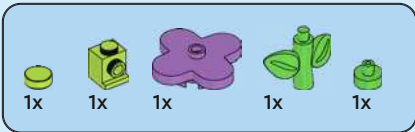
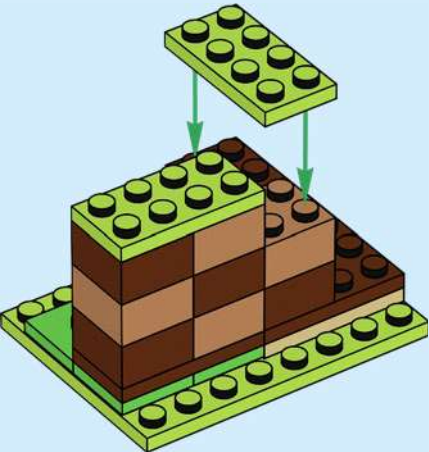

29

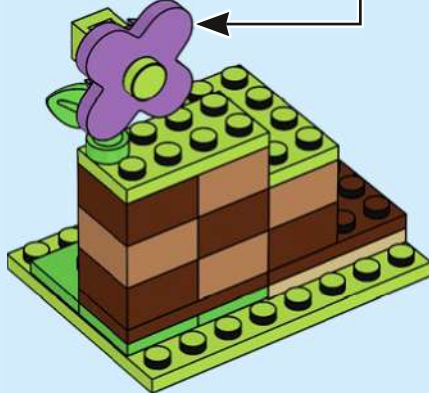
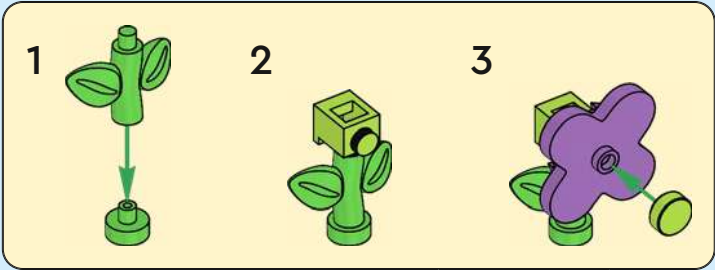

30



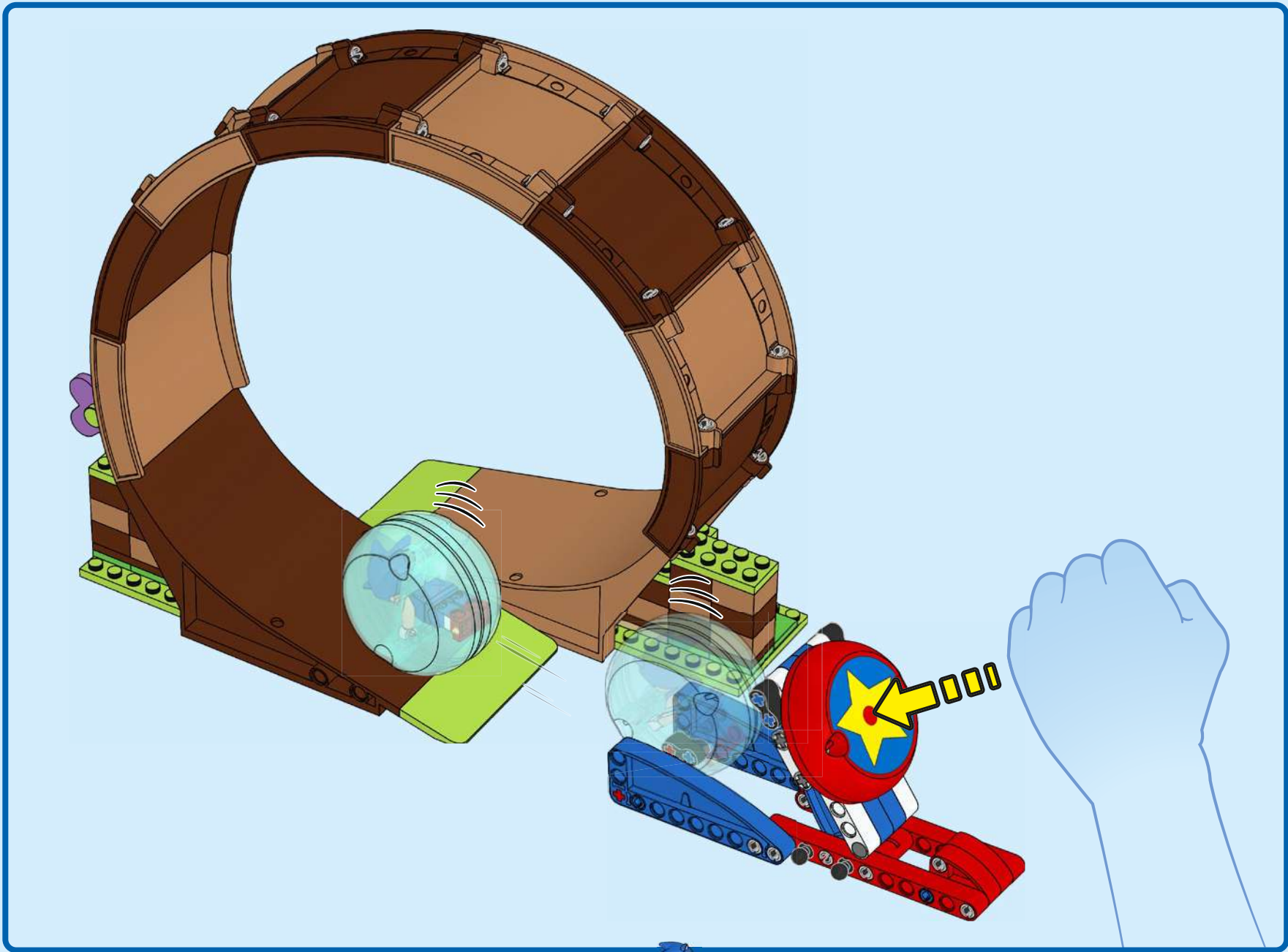



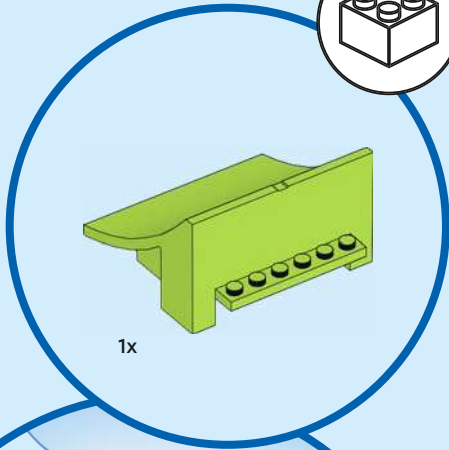
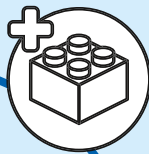

1

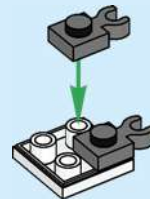

2

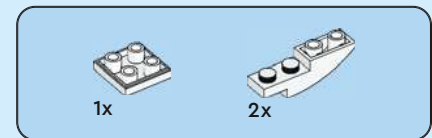
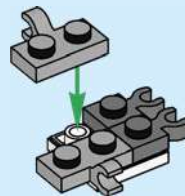

3

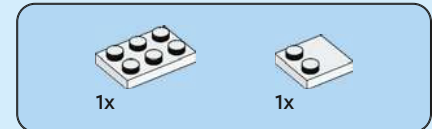
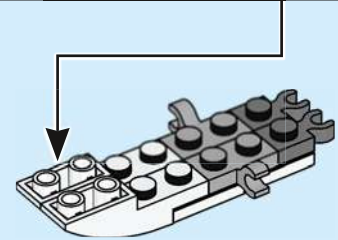
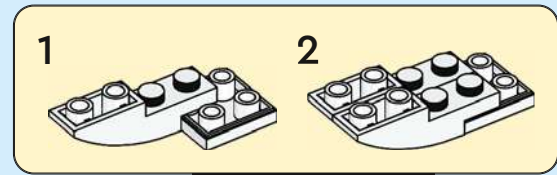

4

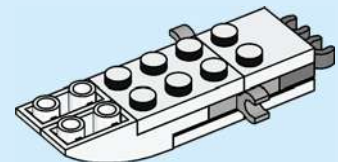

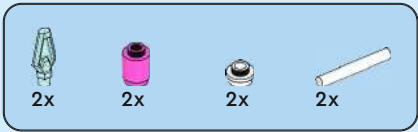

5

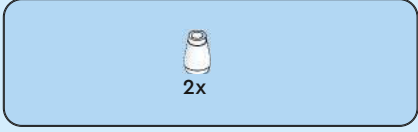
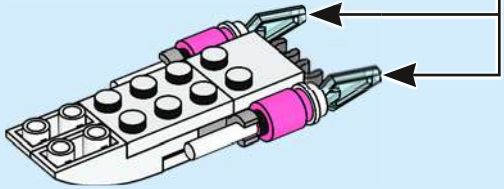
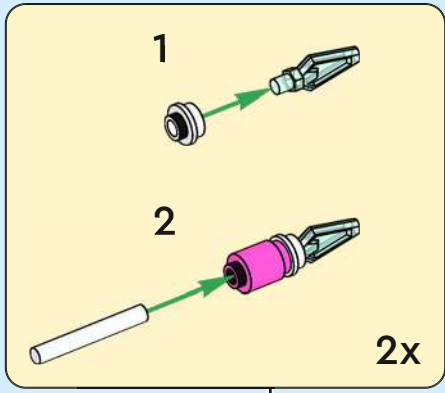

6

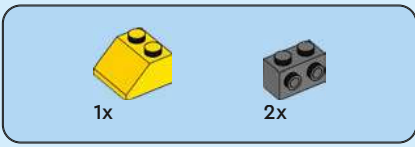

7

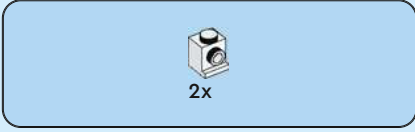
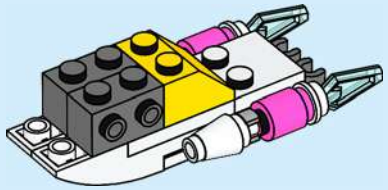

8

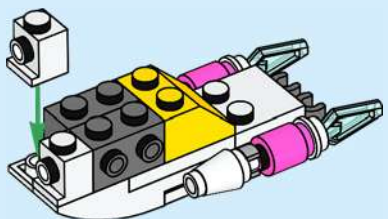

9

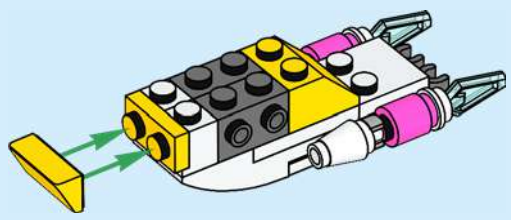

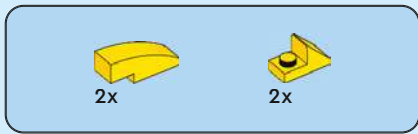

10

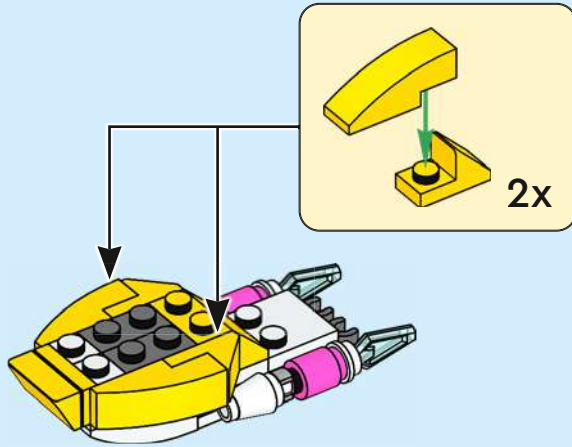

11

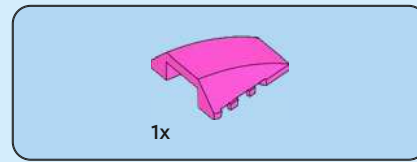
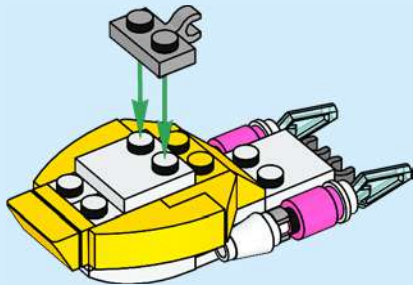

12

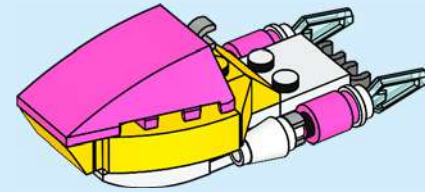

13

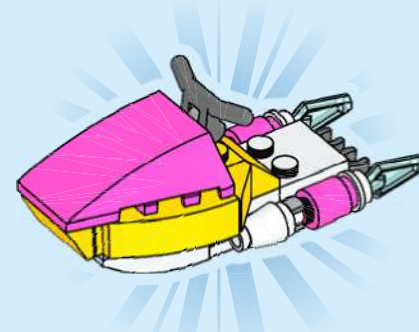

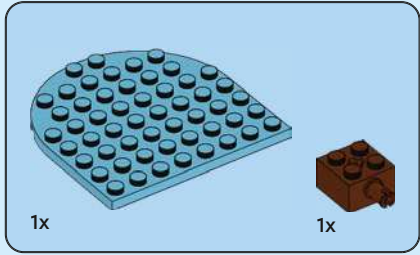
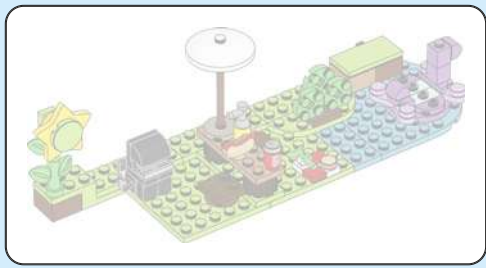

1

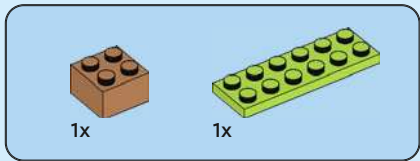
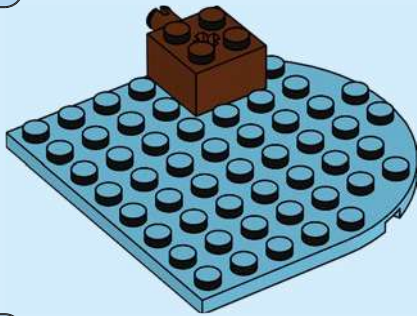

2

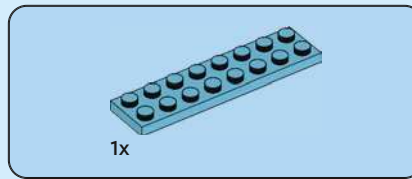
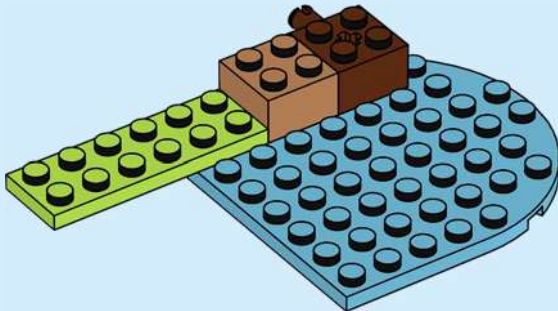

3

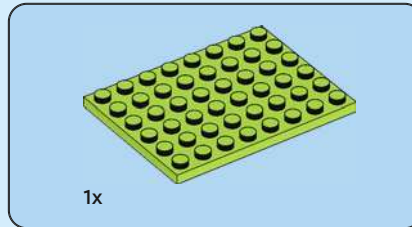
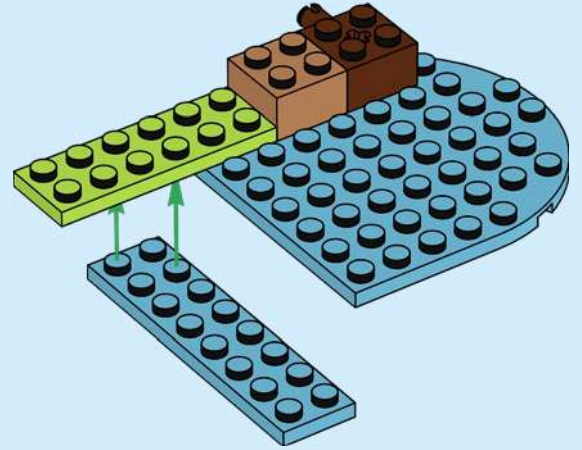

4

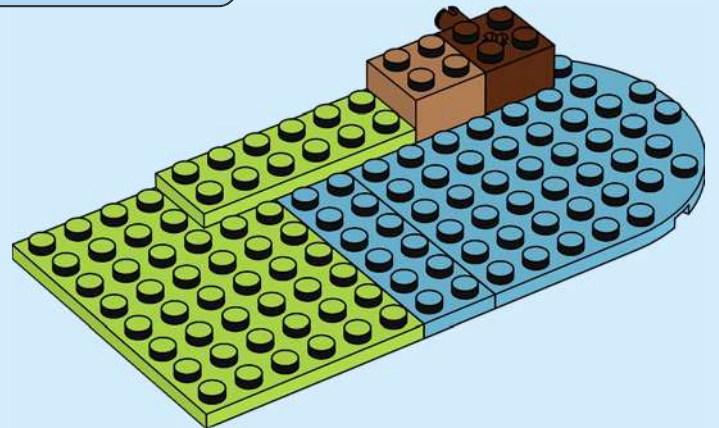



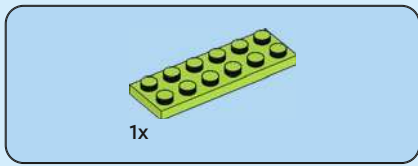

5

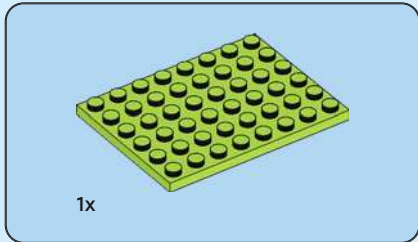
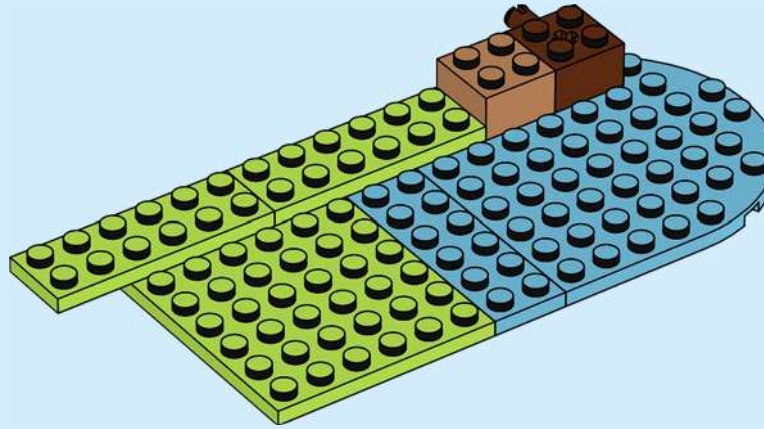

6

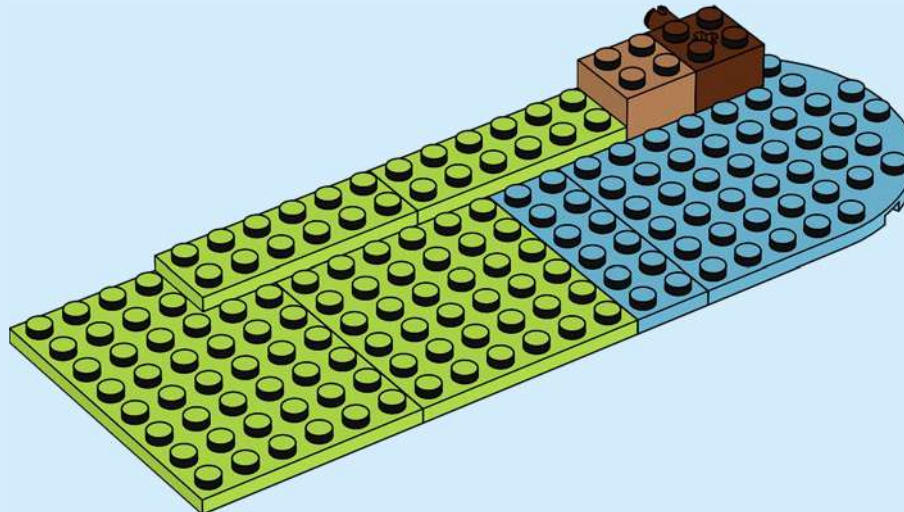



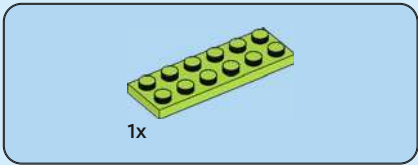

7

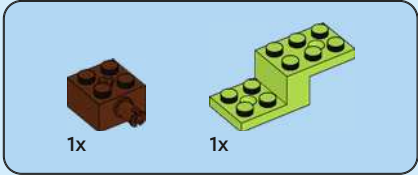
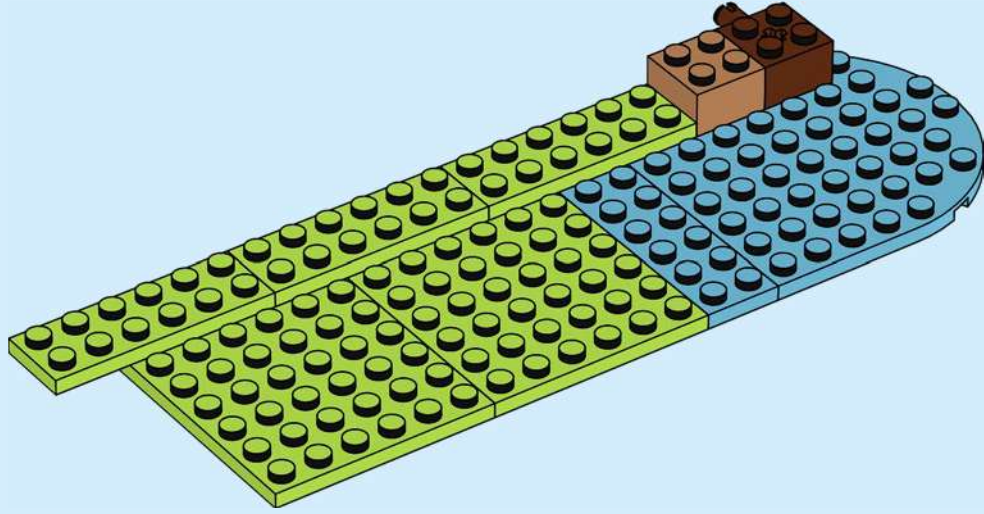

8

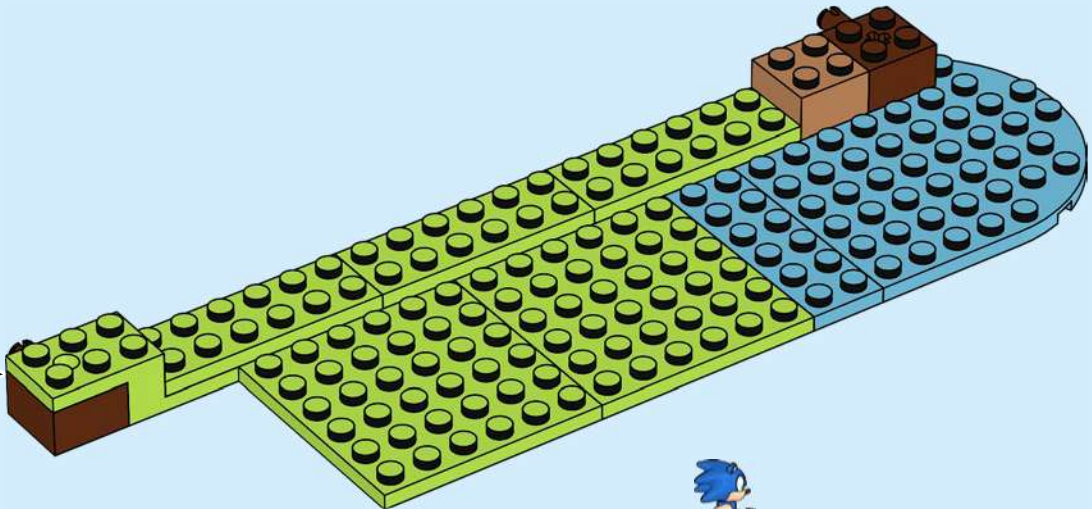
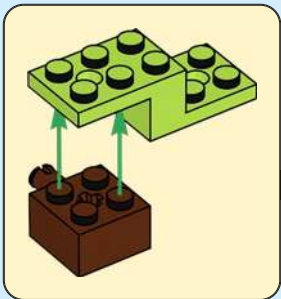

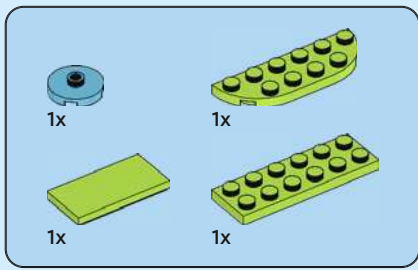

9

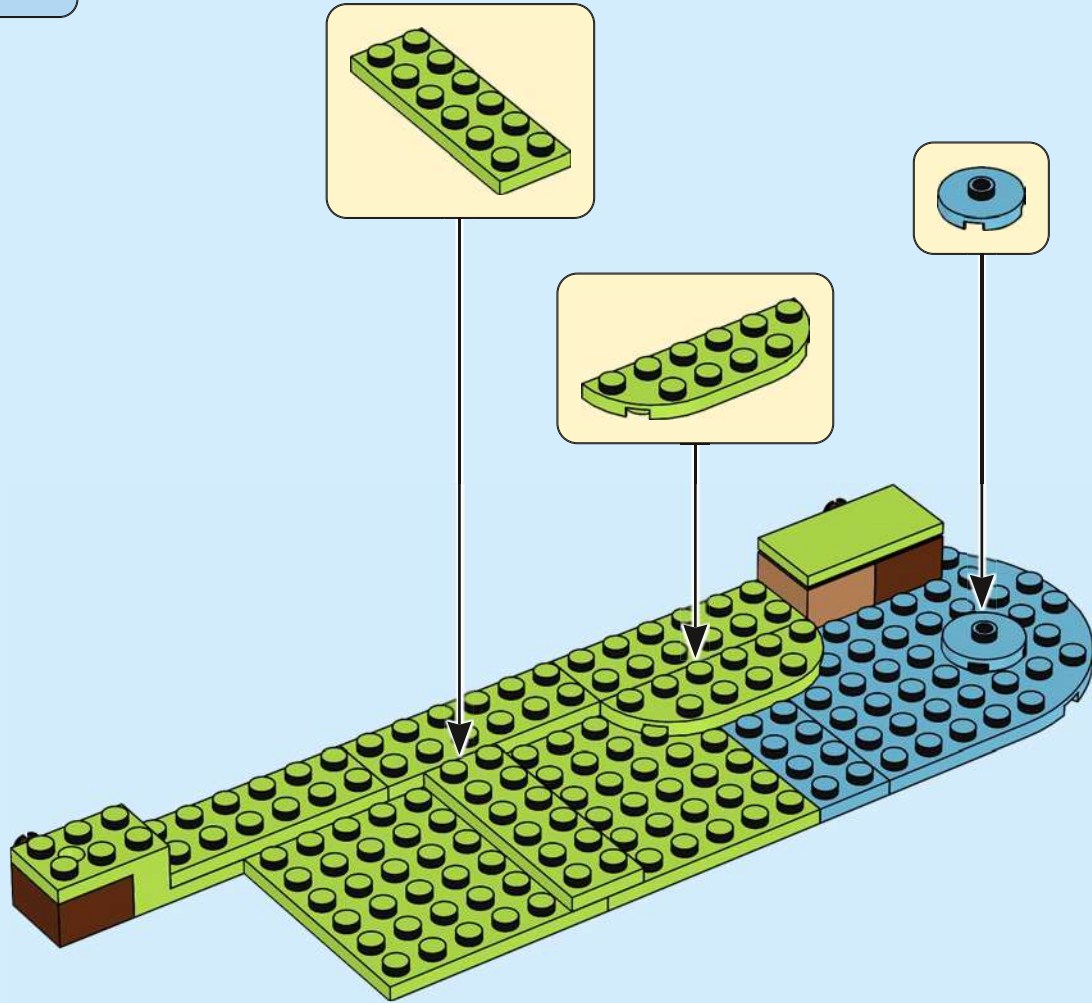

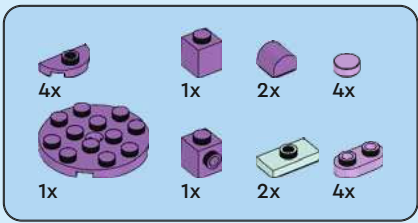

10

1



2

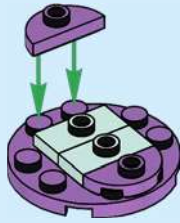

3

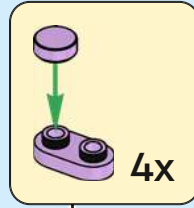

4

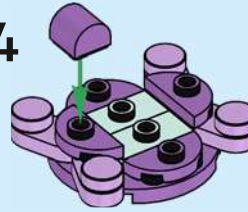

5

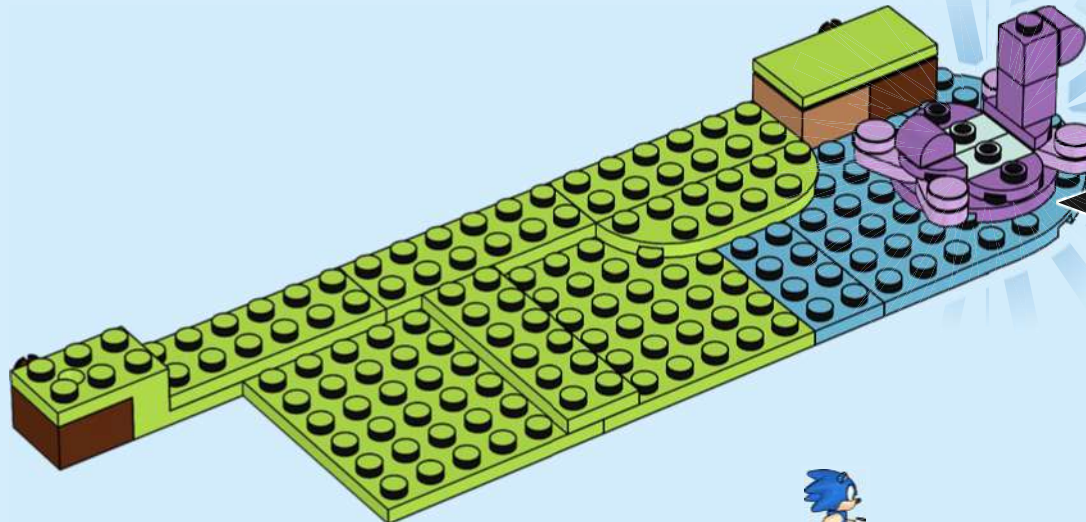
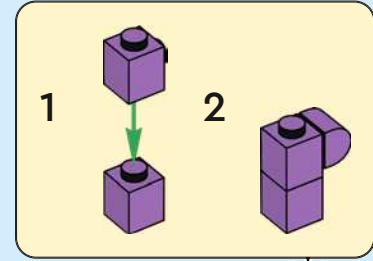





11

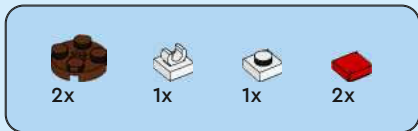
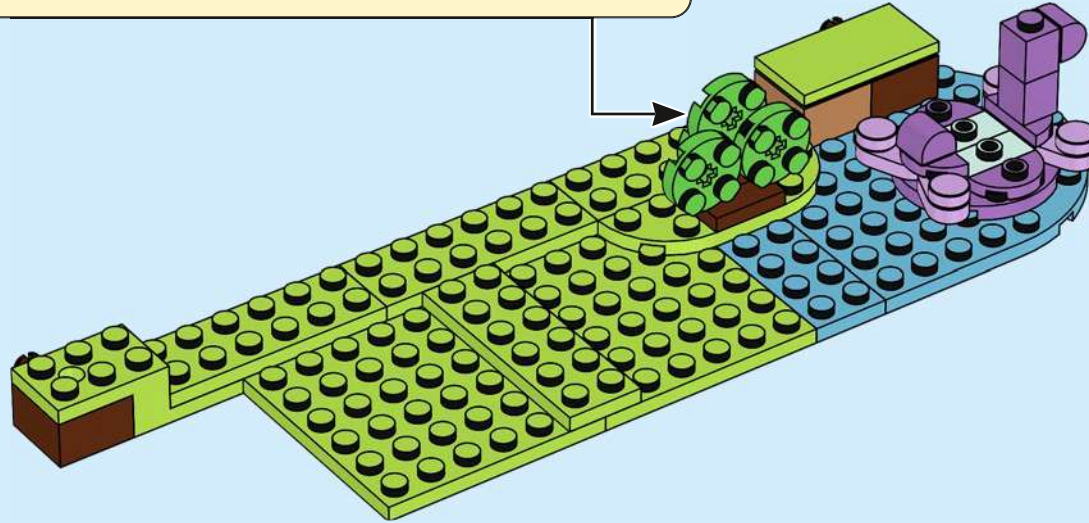
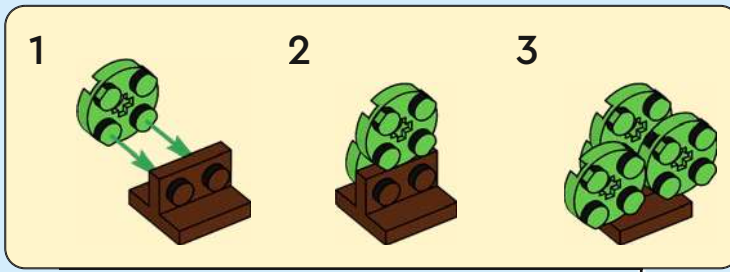

12



2x  
1x  
1x

13





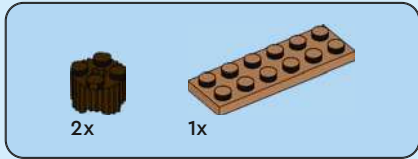
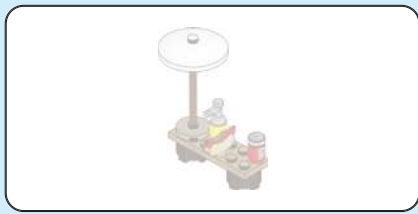

14

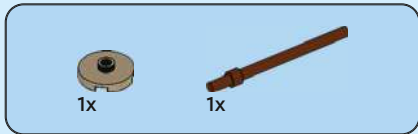

15

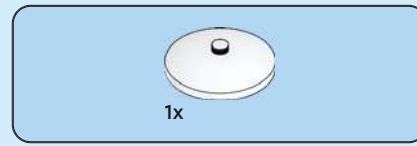
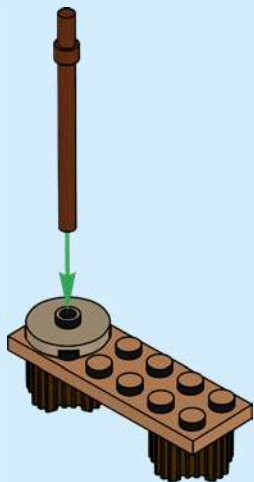

16

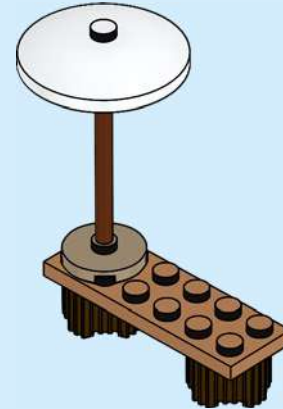

17

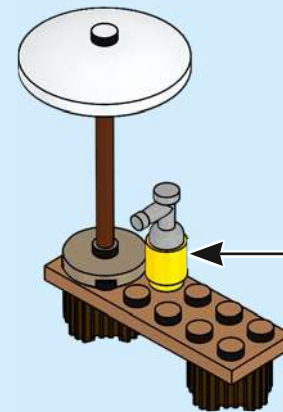



18

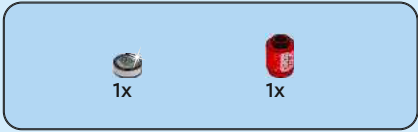
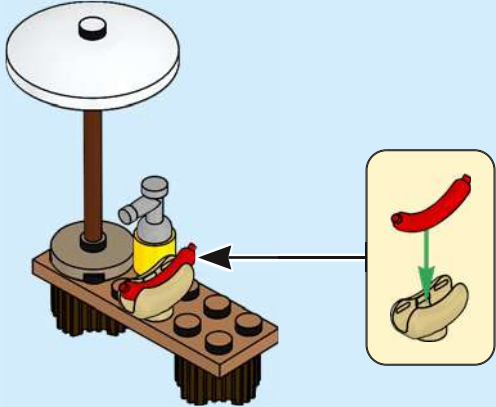

19

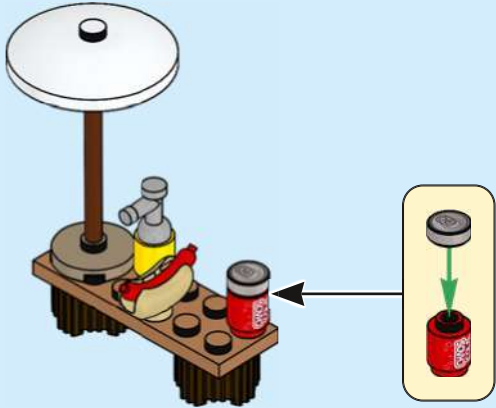

20



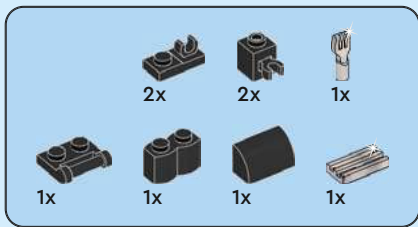

21

1



2

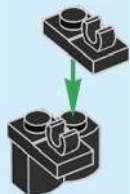

3

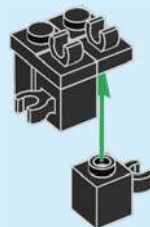

4



5



6

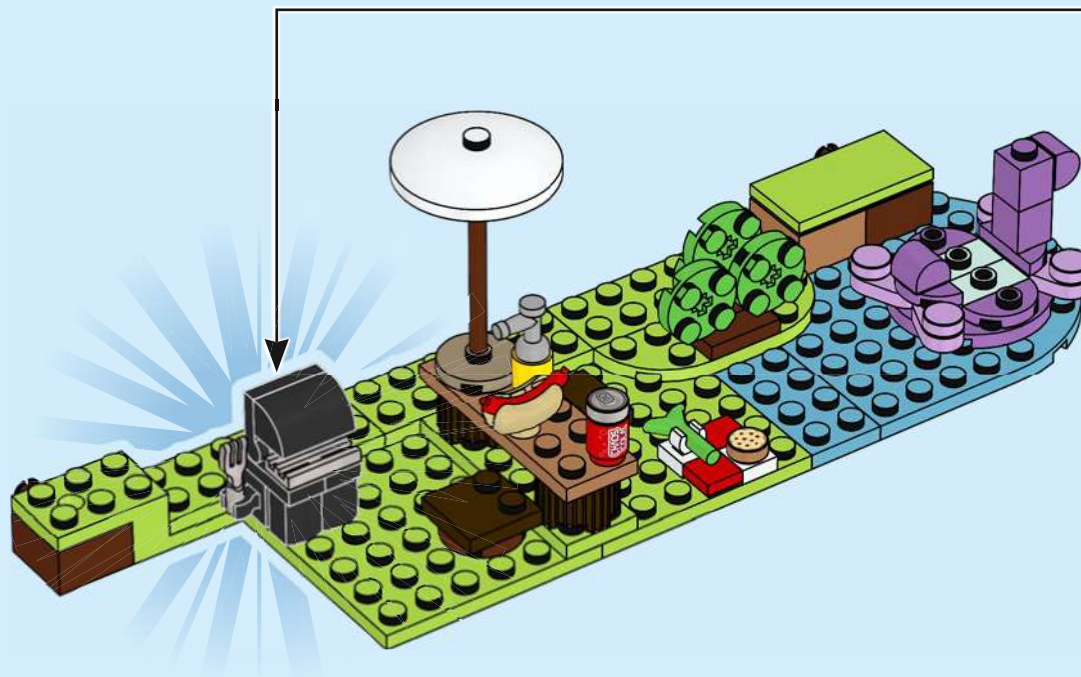

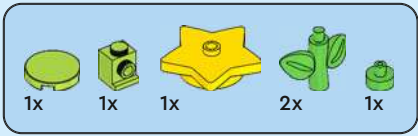

# 22

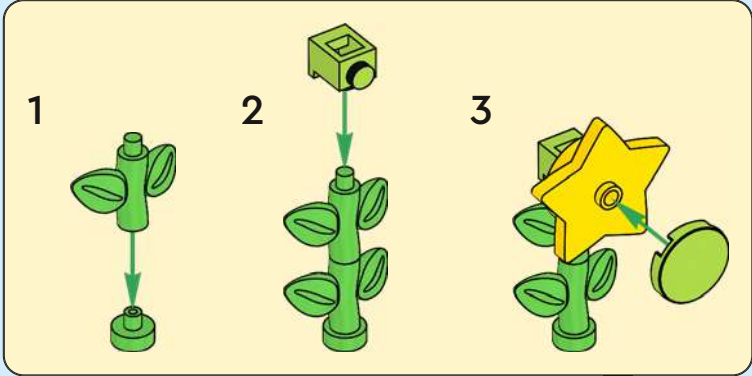



23

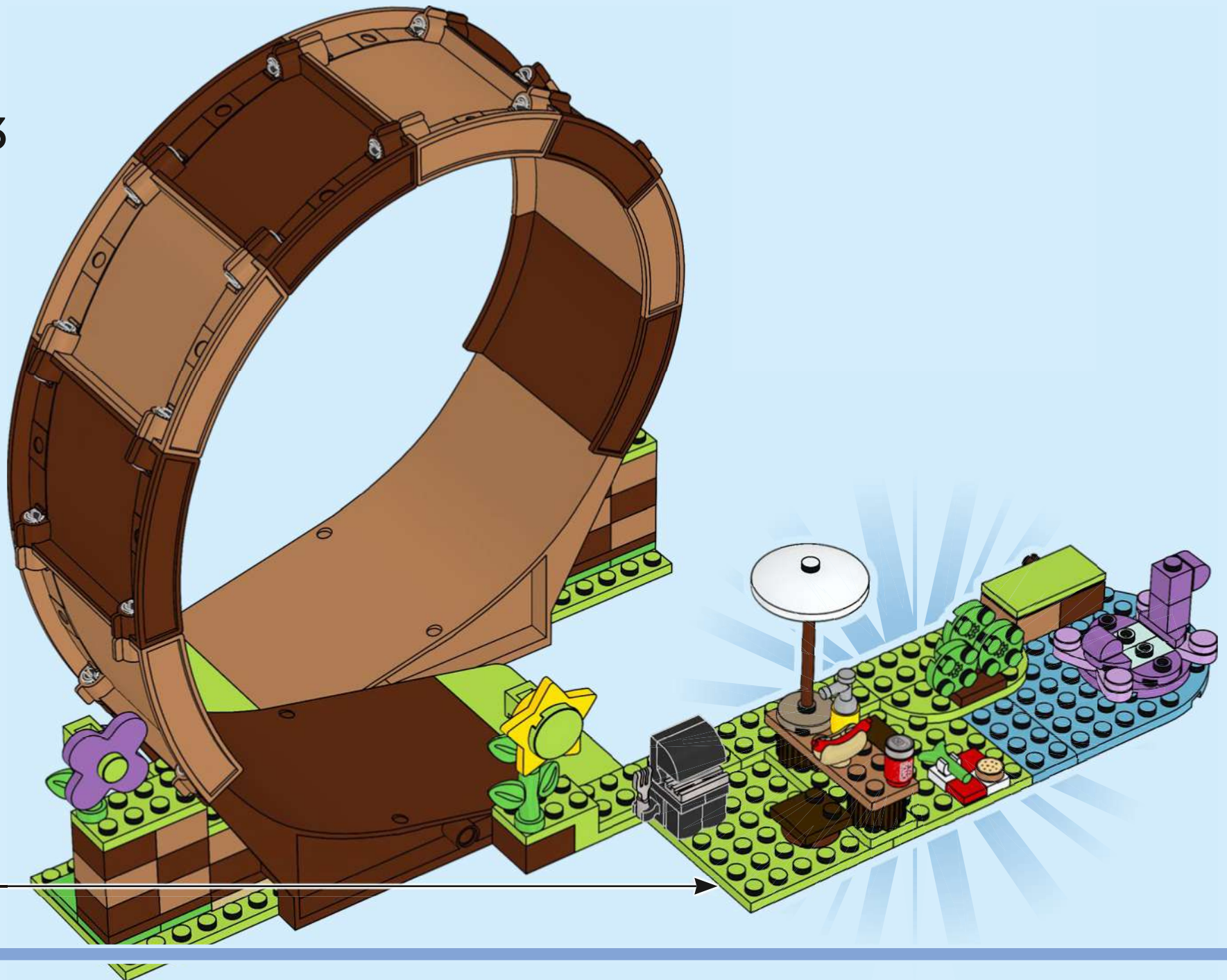



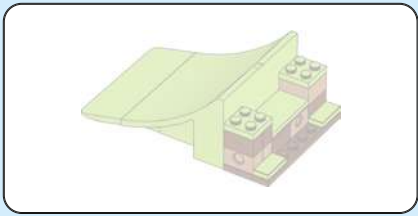

24

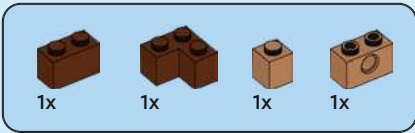
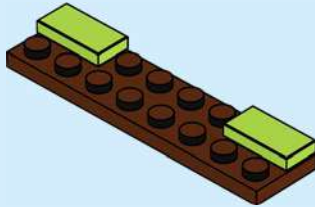

25

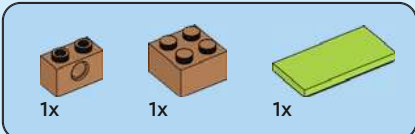
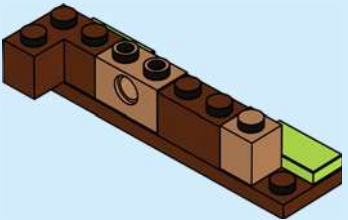

26

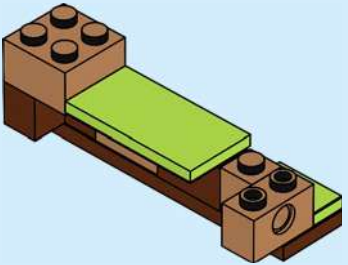



27

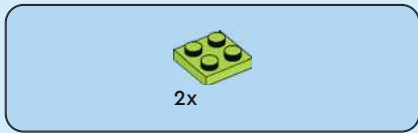
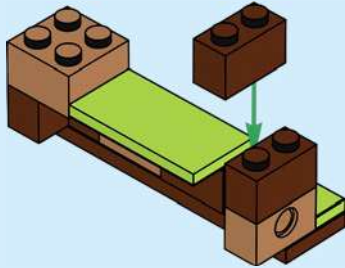

28

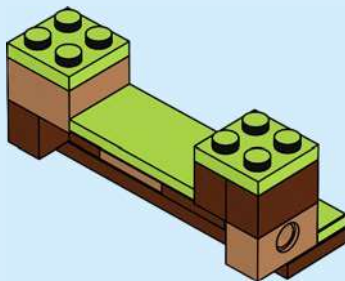

29

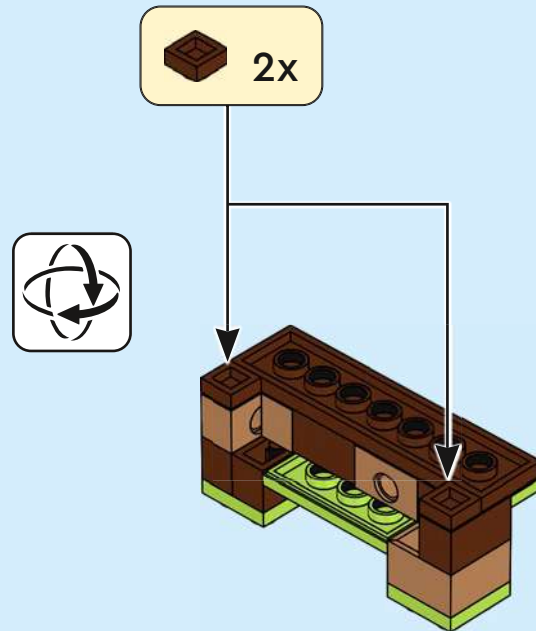

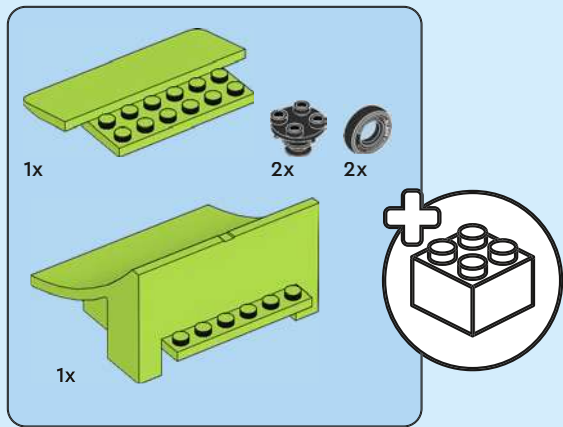

30

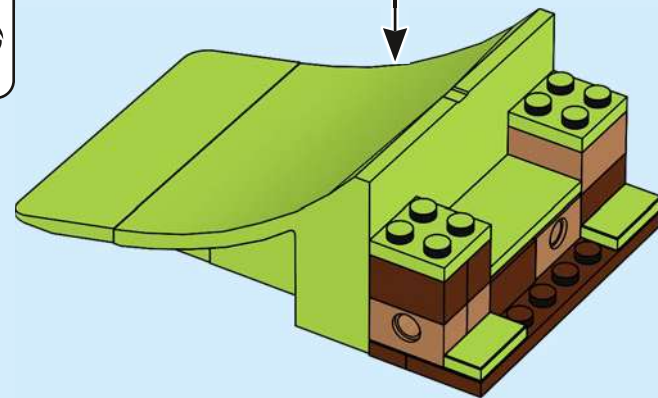
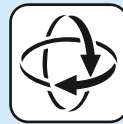
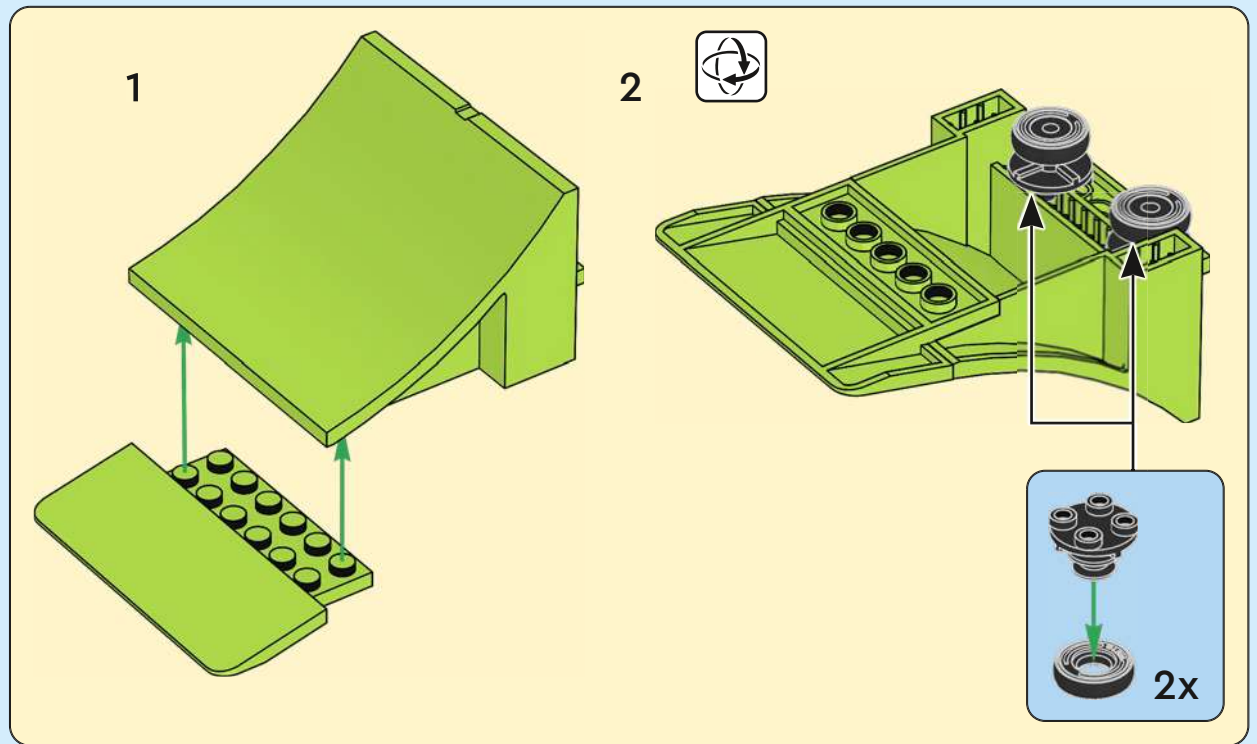

31

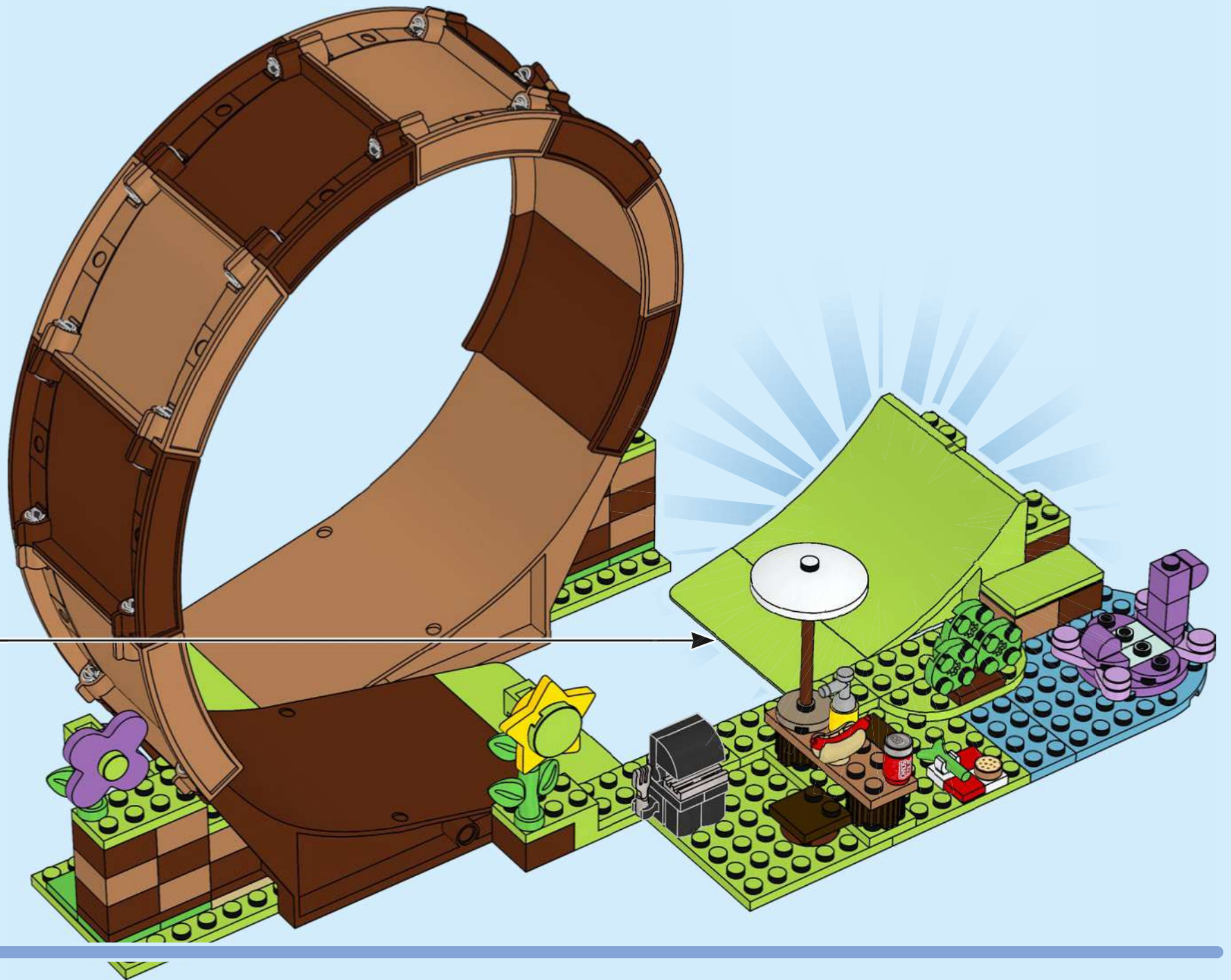



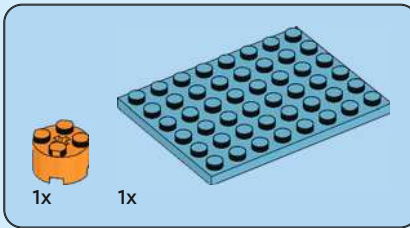

32

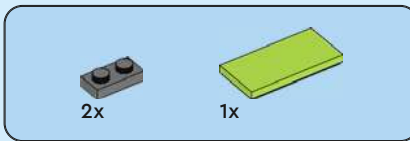
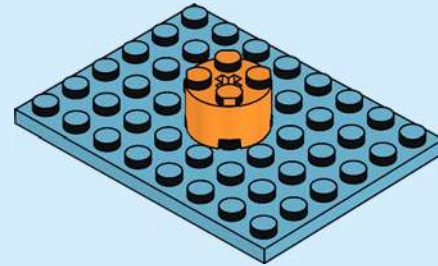

33

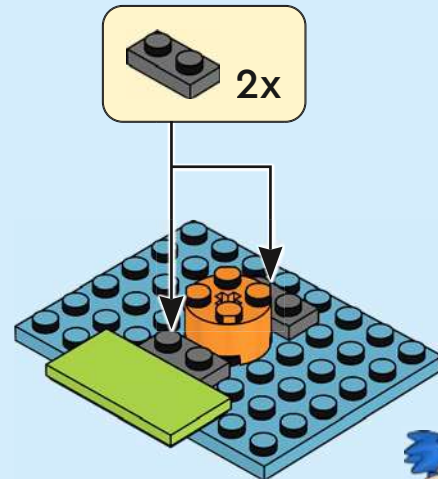



34

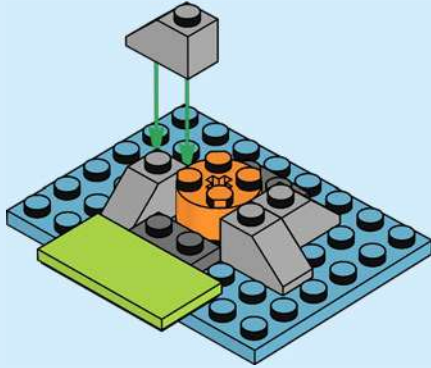

35

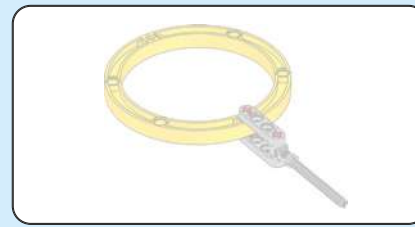
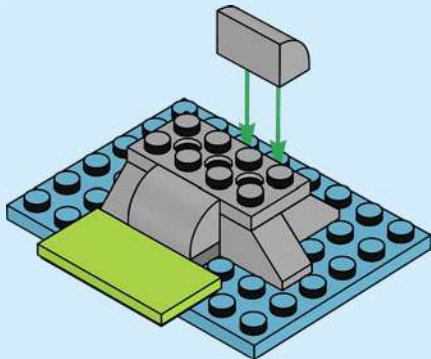

36

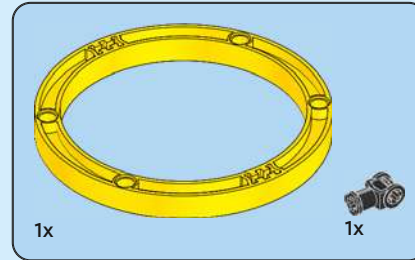
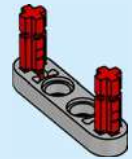

37

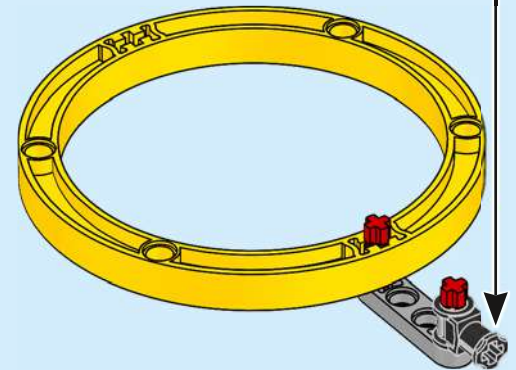

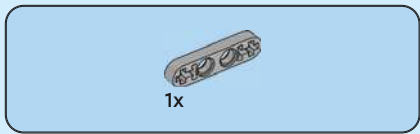

38

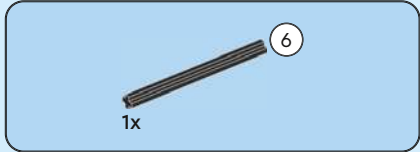
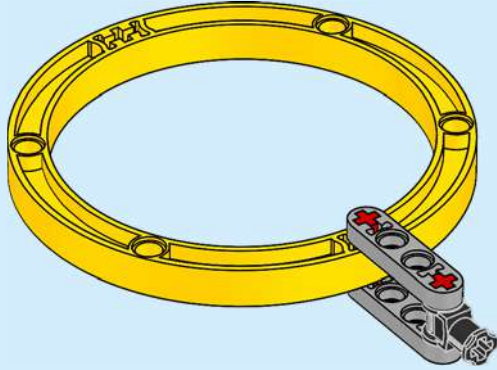

39

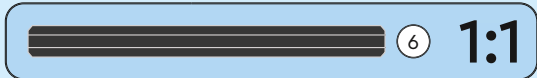
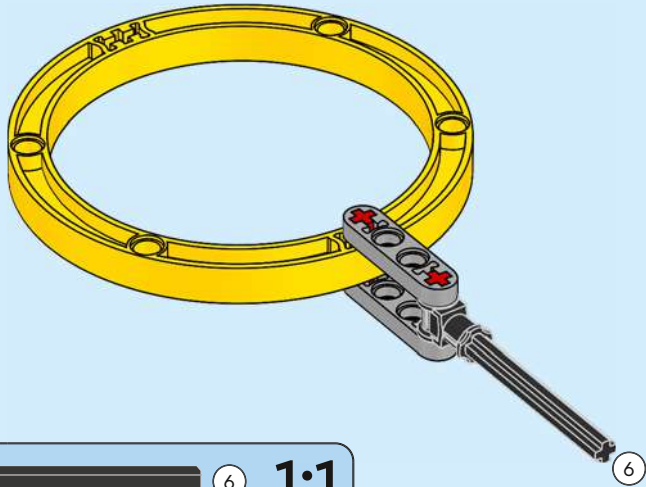

40

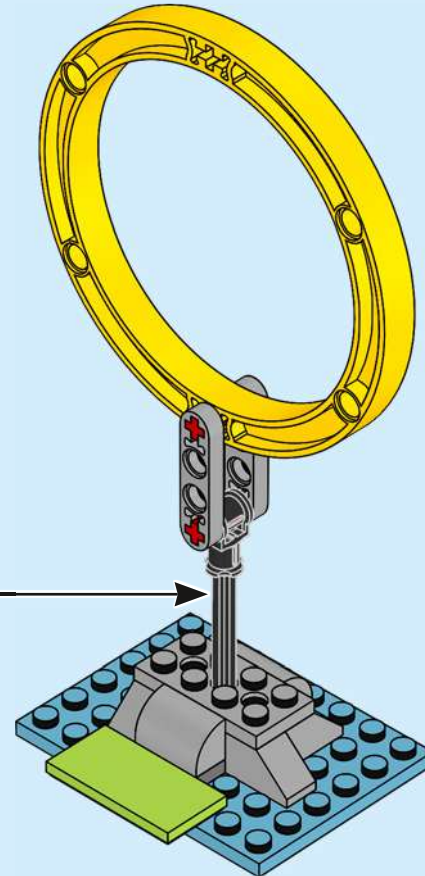

41

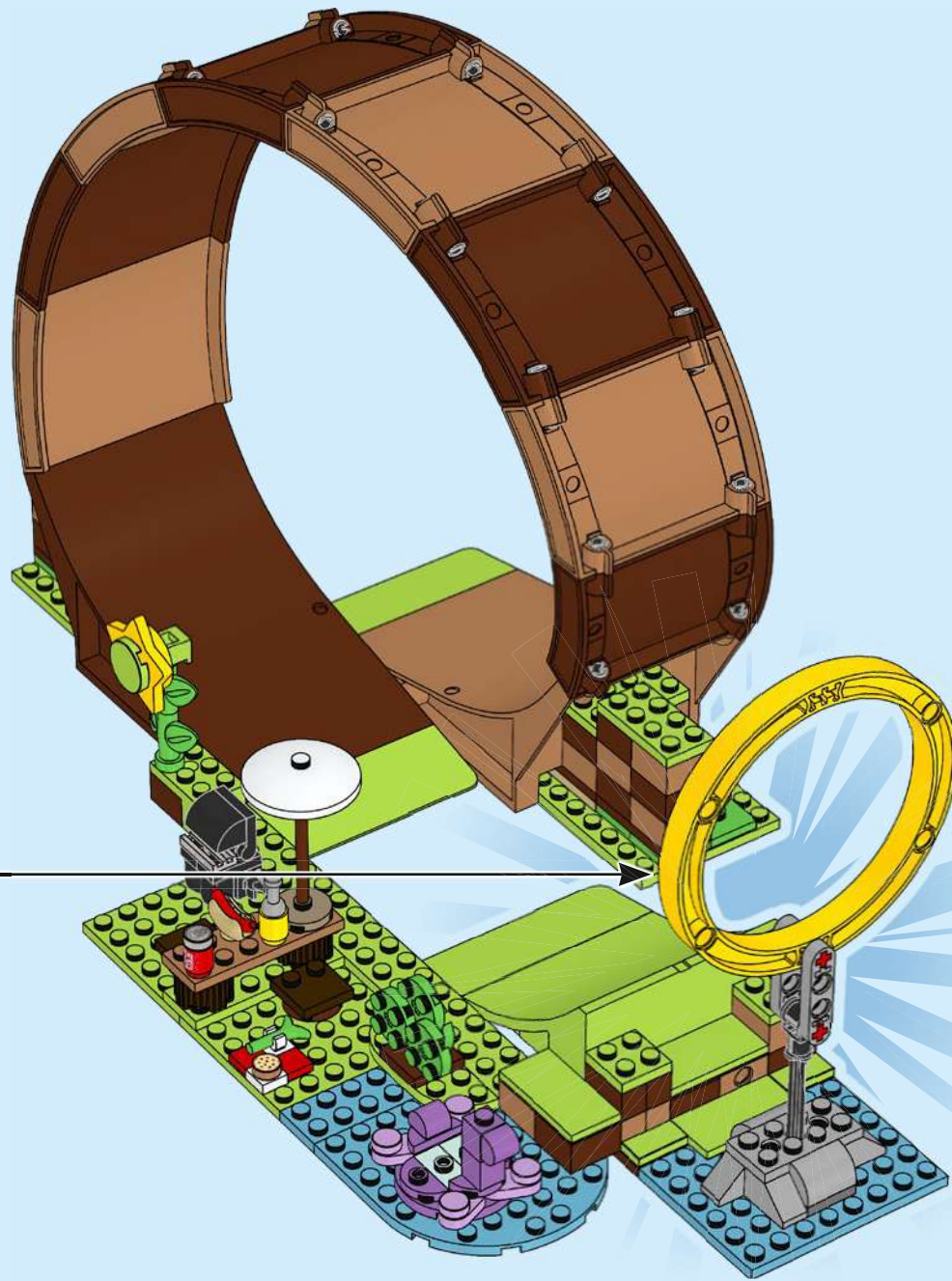



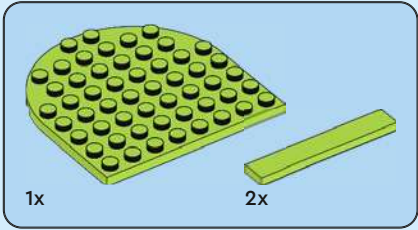
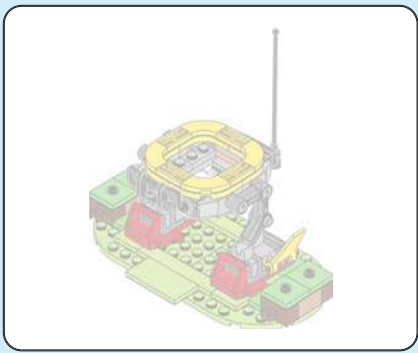

1

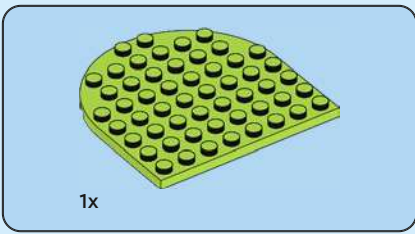
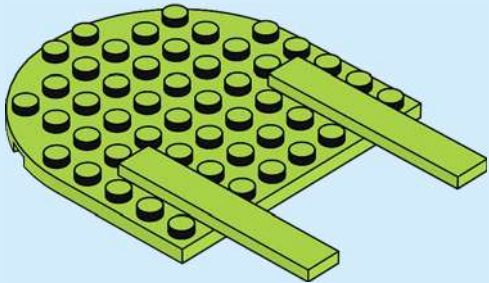

2

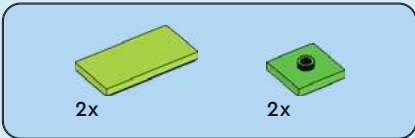
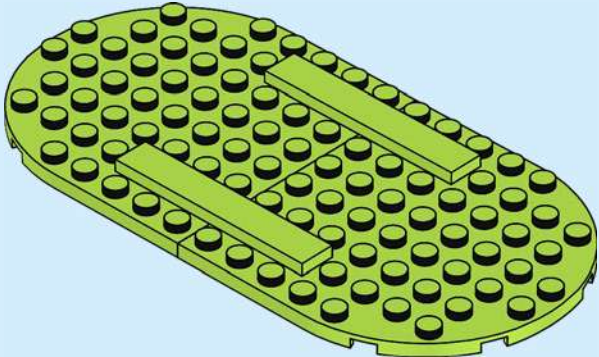

3

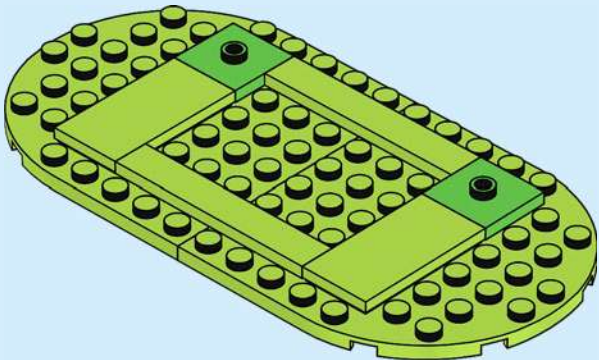

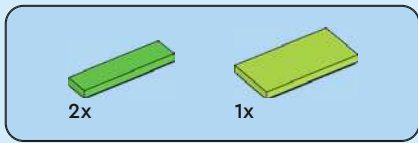

4

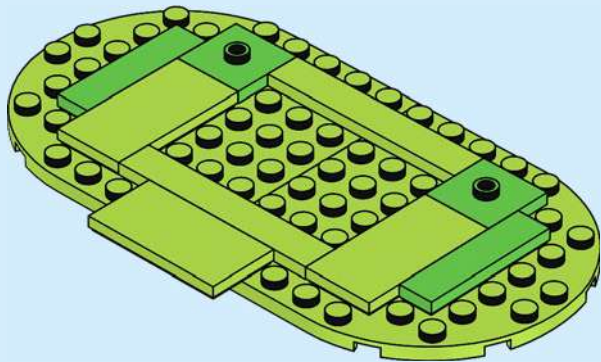

5

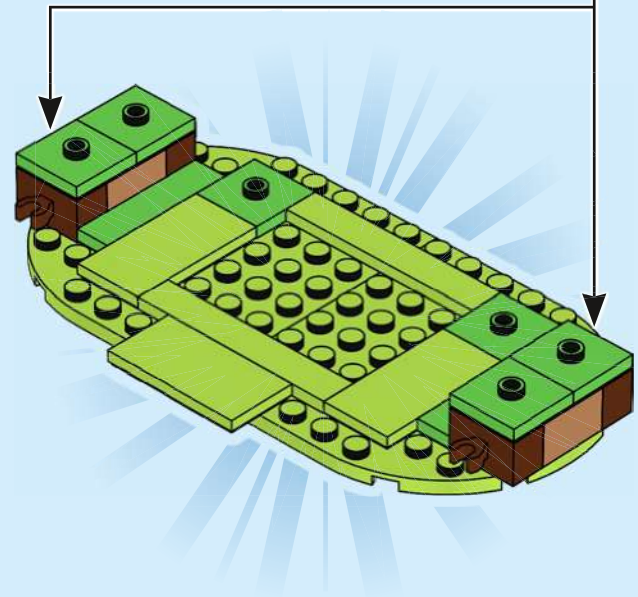
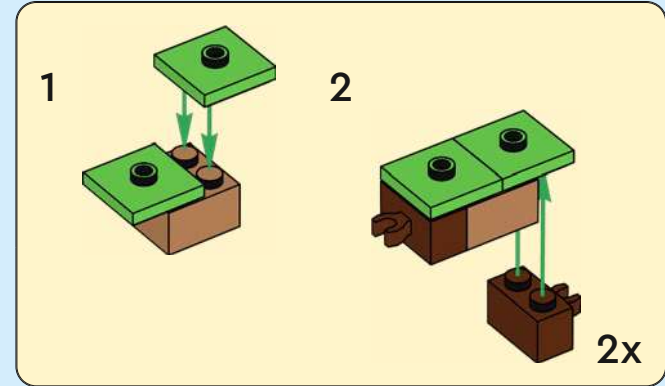

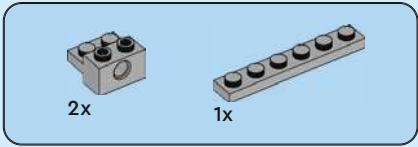
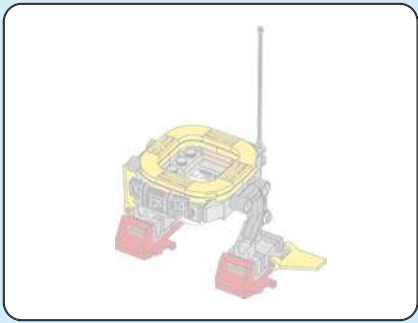

6

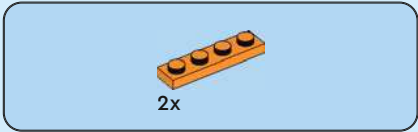
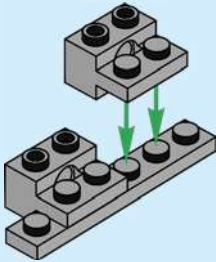

7

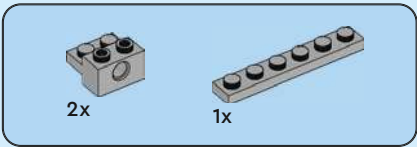
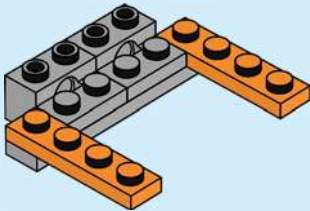

8

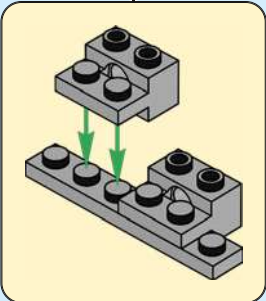
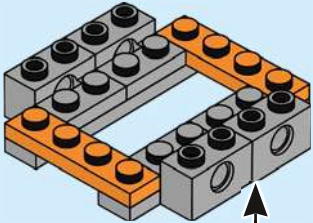

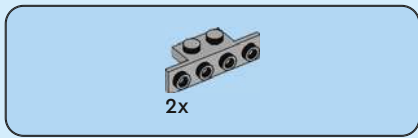

9

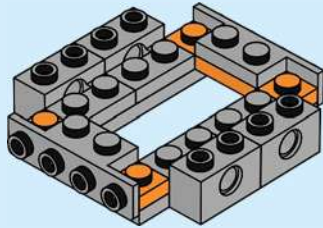

10

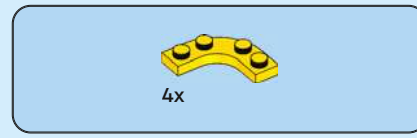
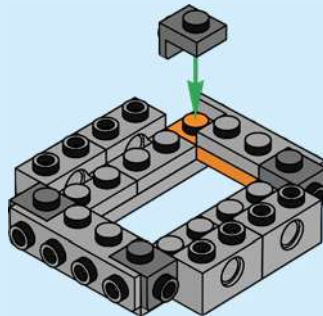

11

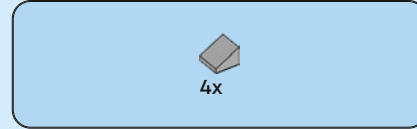
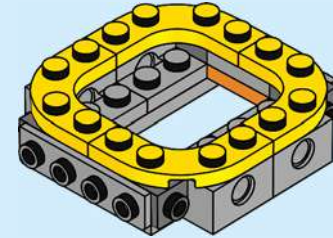

12

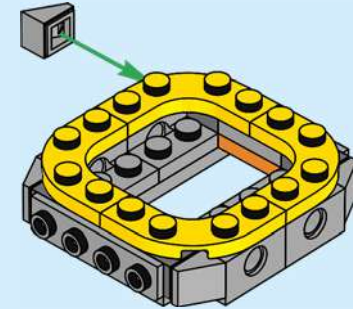





4x

# 13

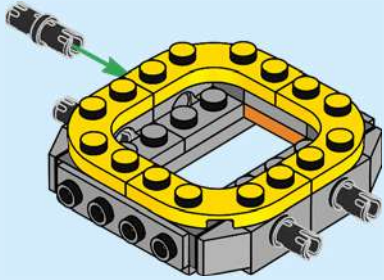

4x



4x

# 14

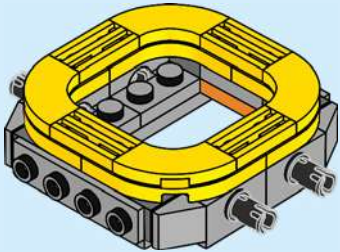

2x



1x

# 15

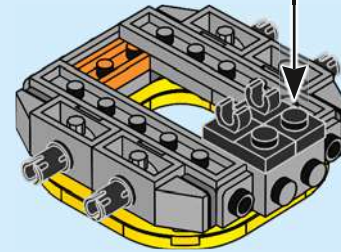
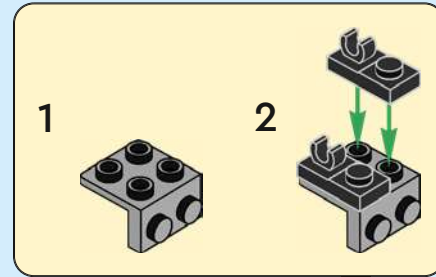

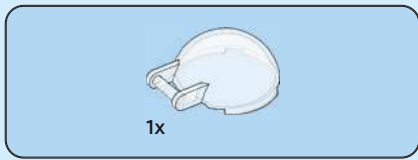

16

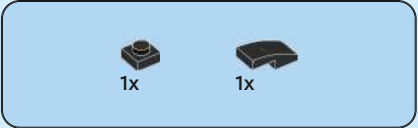
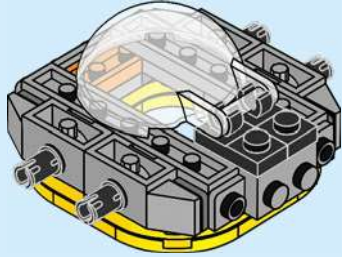

17

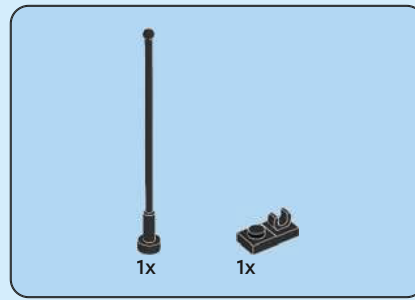
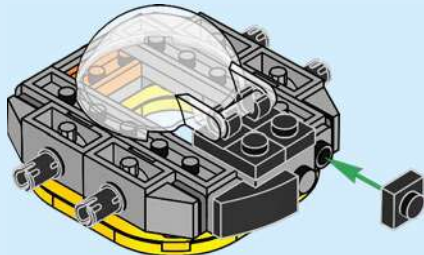

18

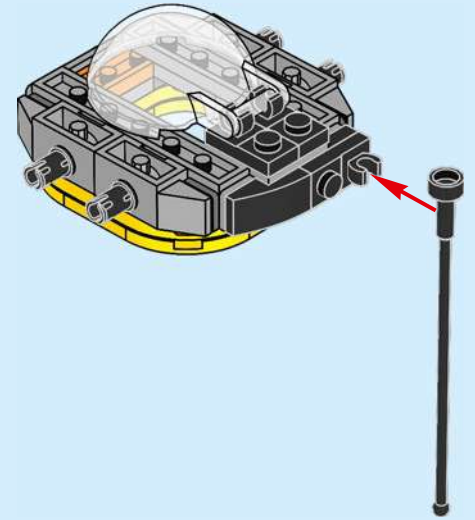

19

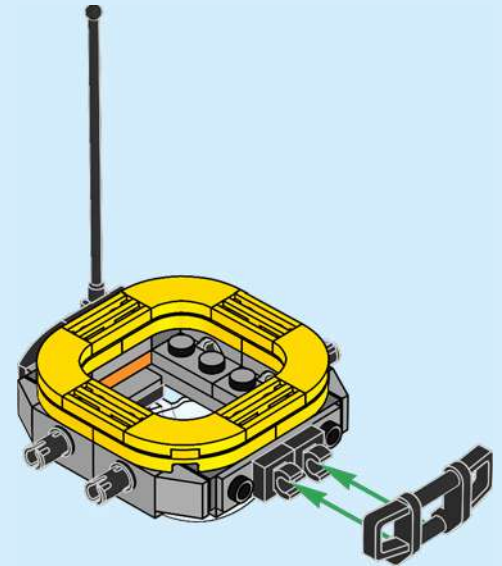
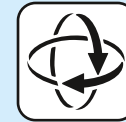

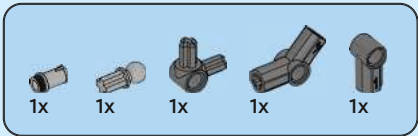

20

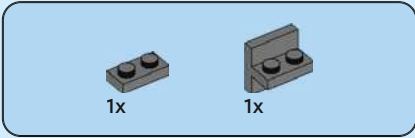
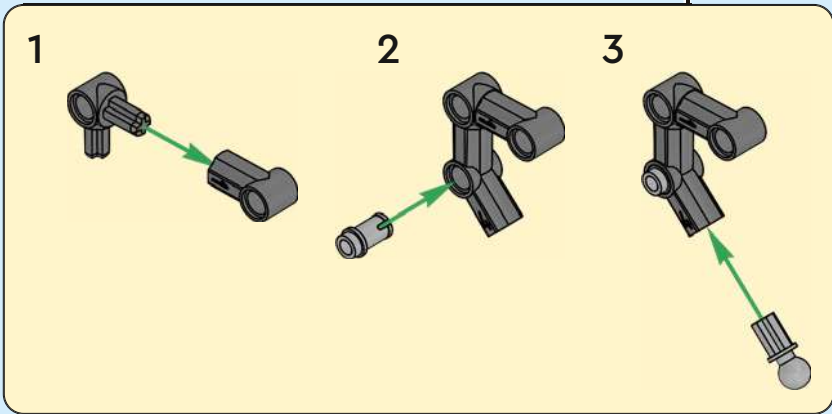
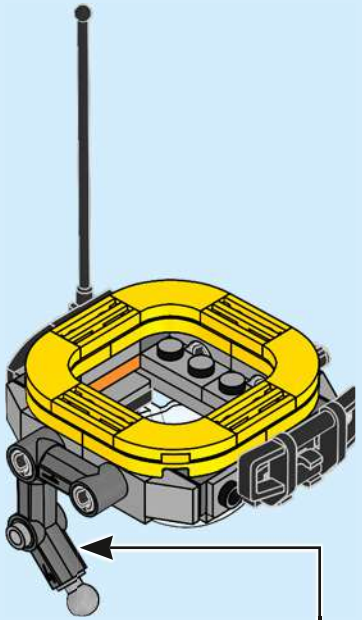

21

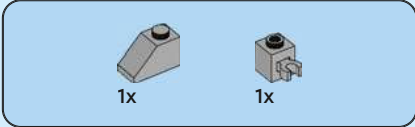
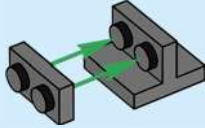

22

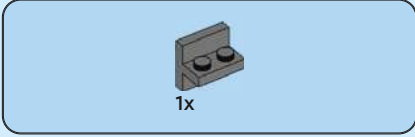
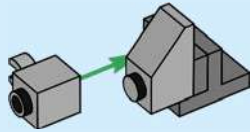

23

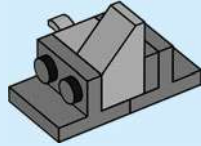

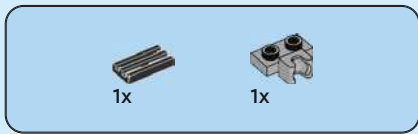

24

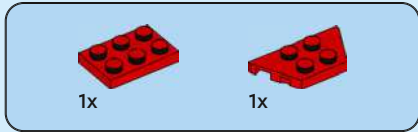
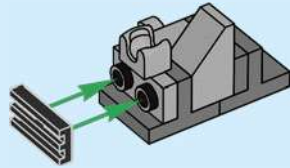

25

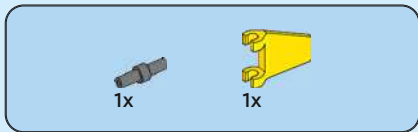
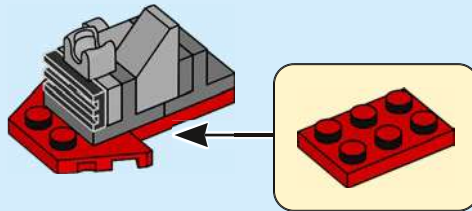

26

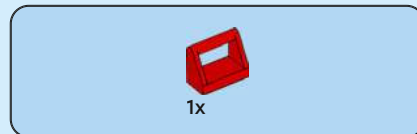
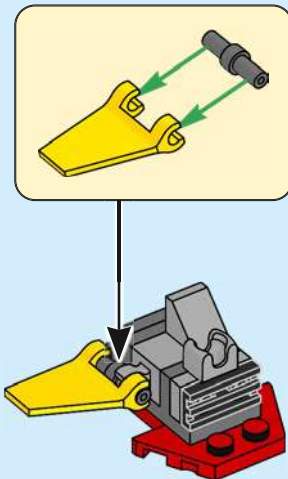

27

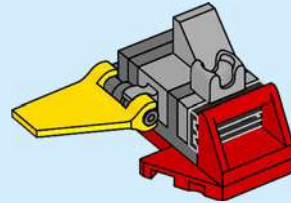

28

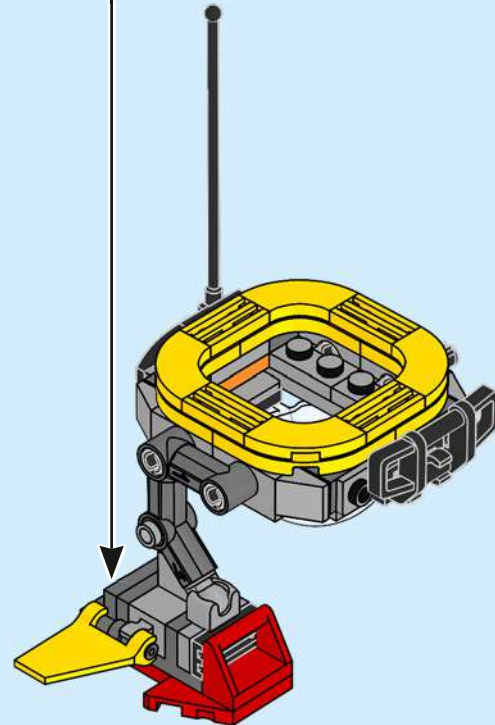



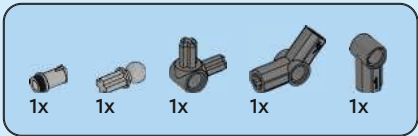

# 29

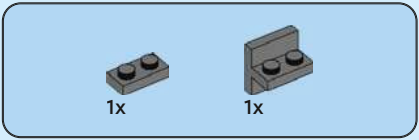
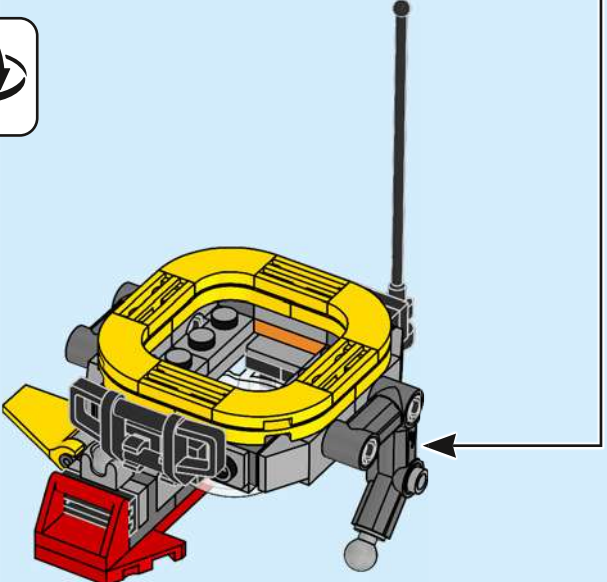
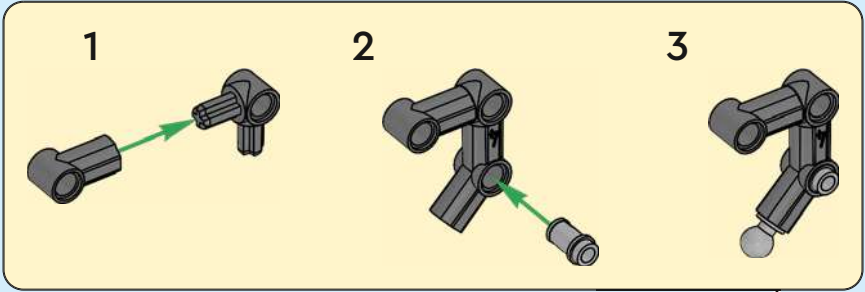

# 30

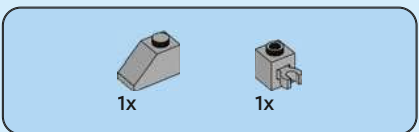
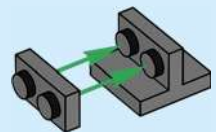

# 31

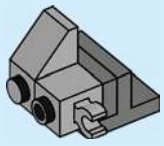

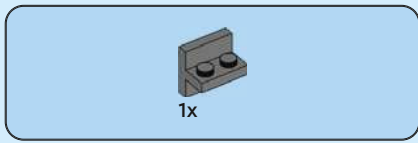

32

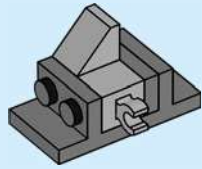

33

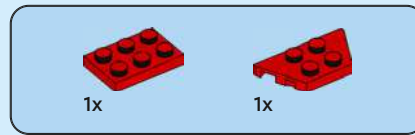
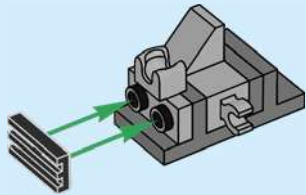

34

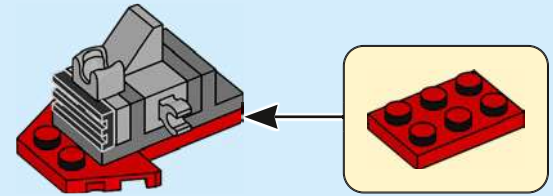

35

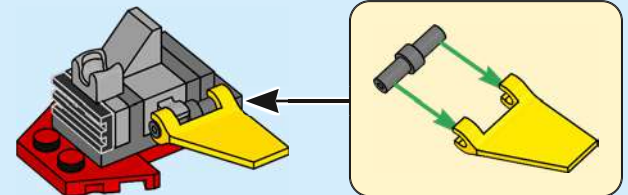



1x

36

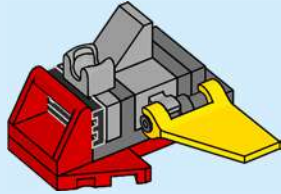

37

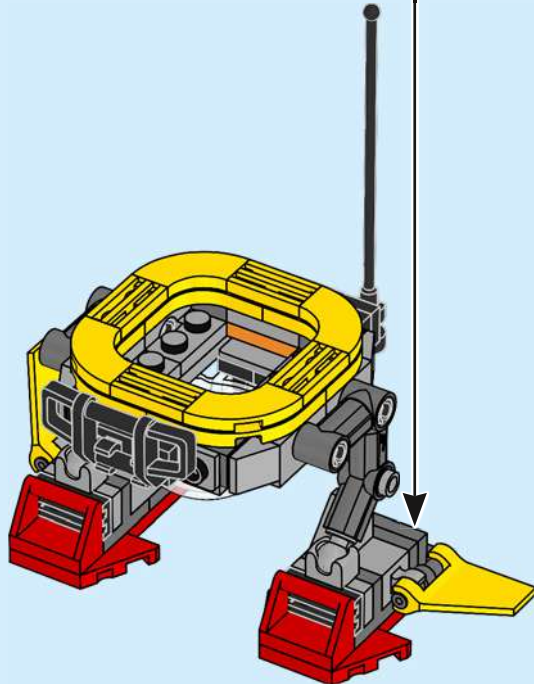

38

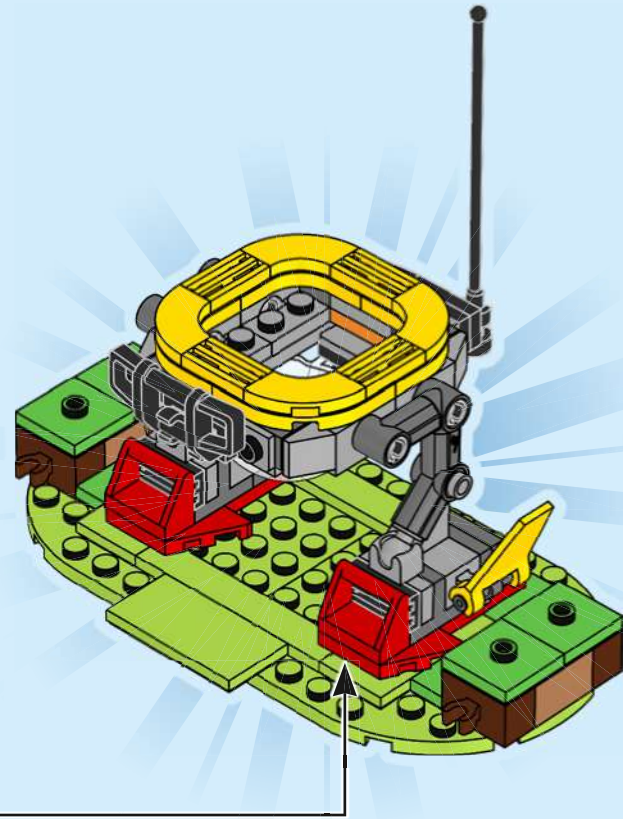

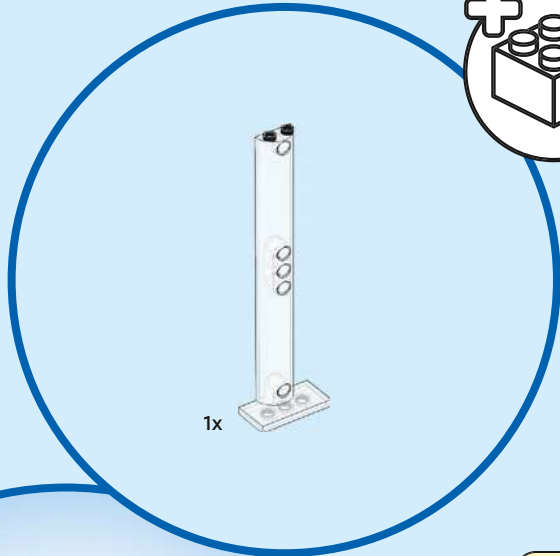
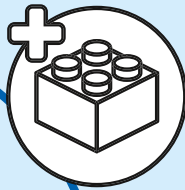

1x

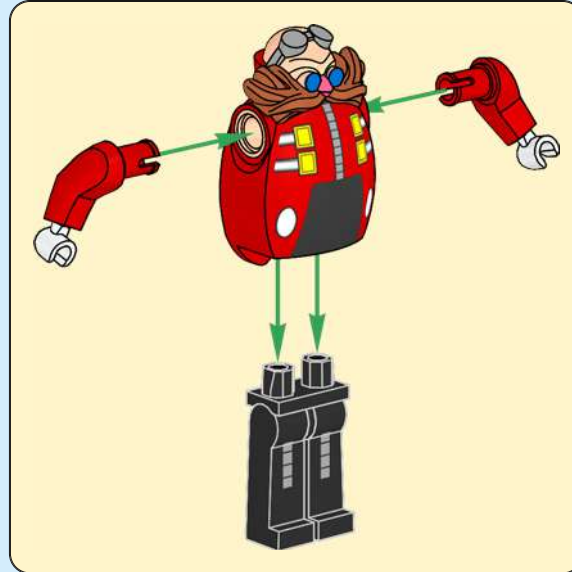



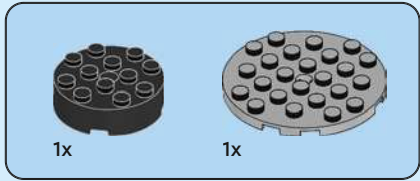
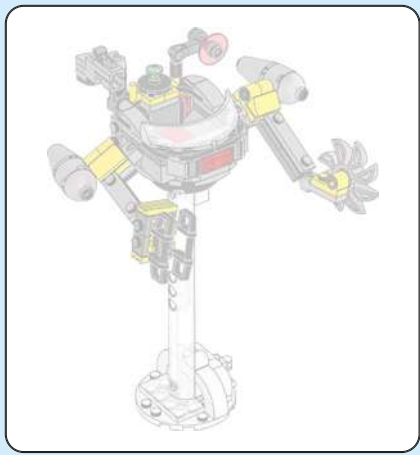

1

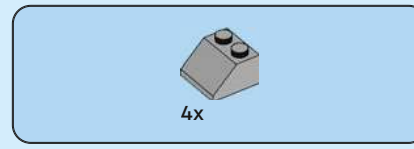
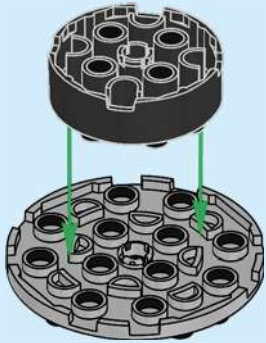

2

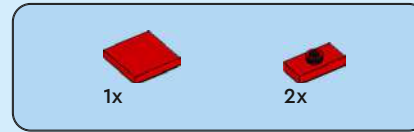
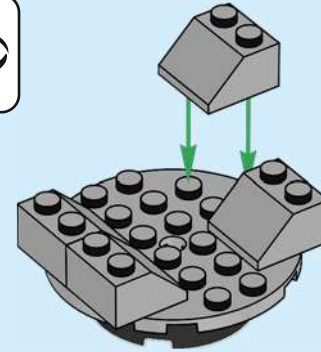

3

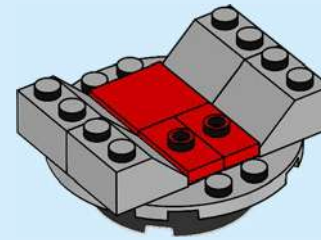



4

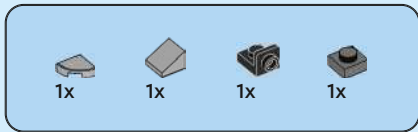
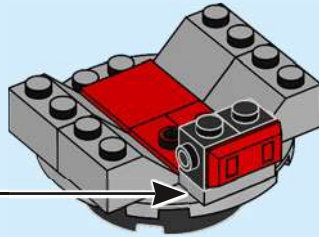
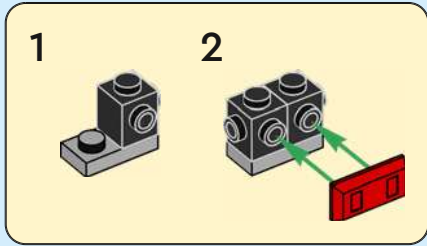

5

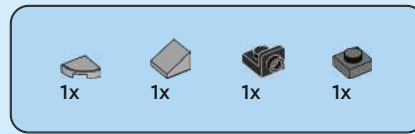
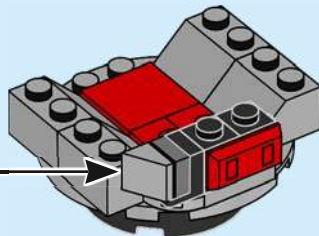
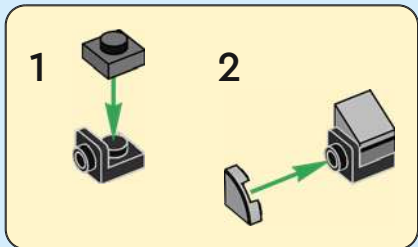

6

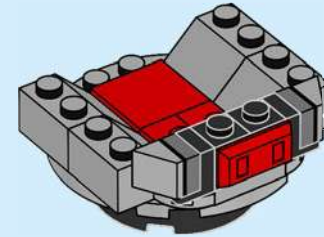
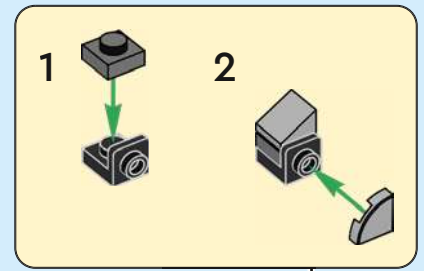

7

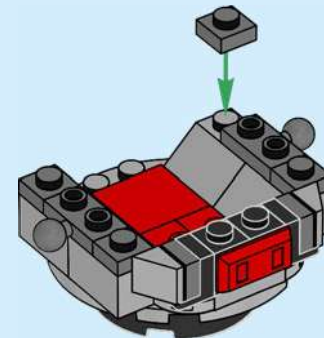



8

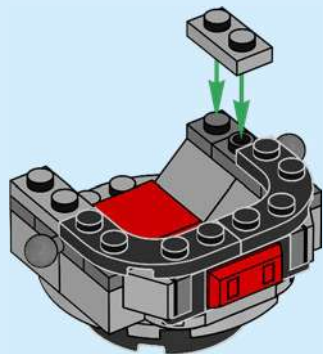

9

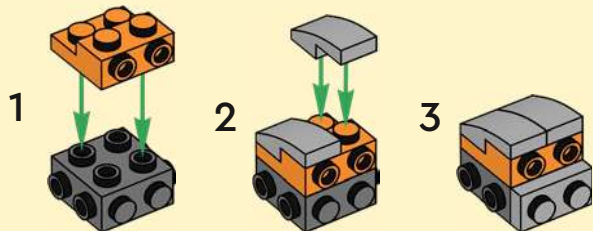
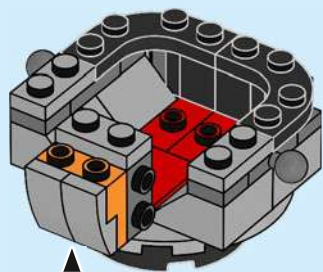

10

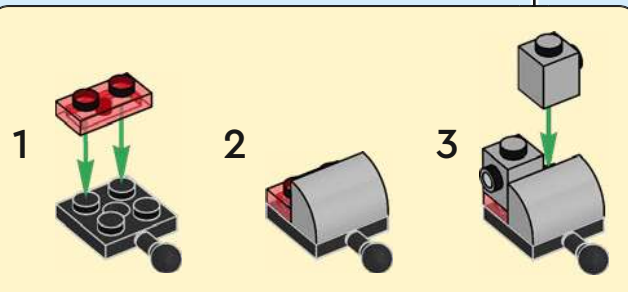
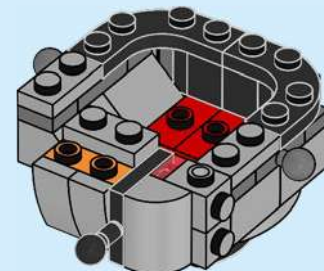

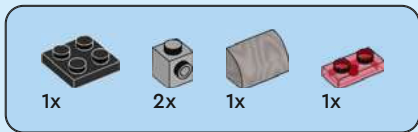

11

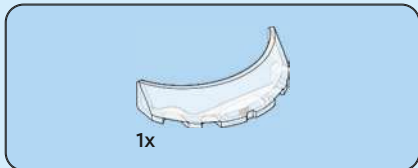
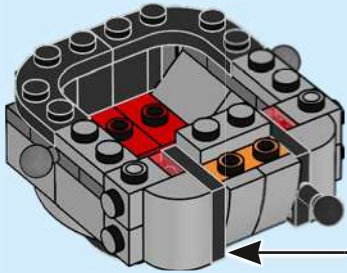
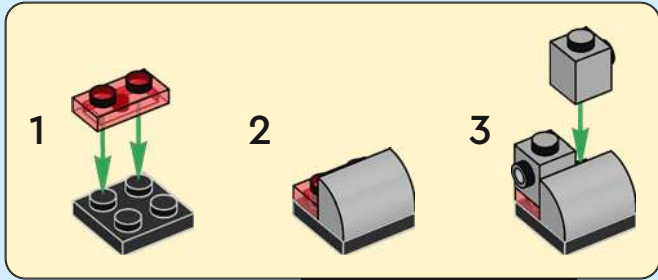

12

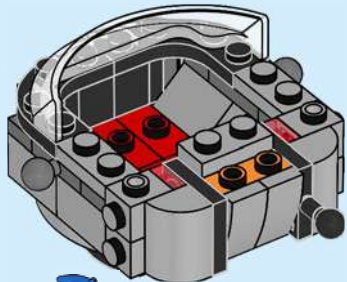

13

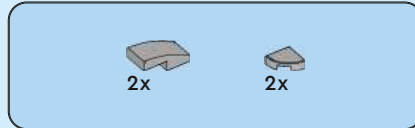
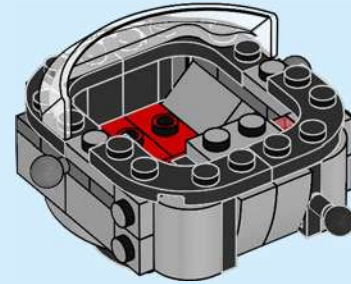

14

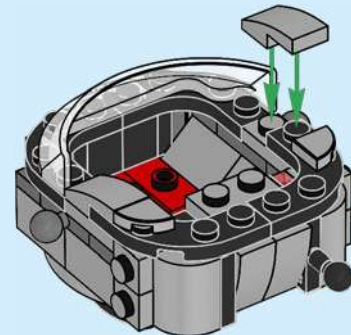



15

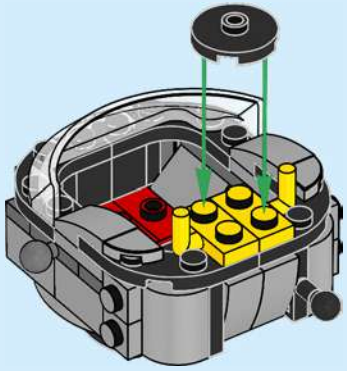

16

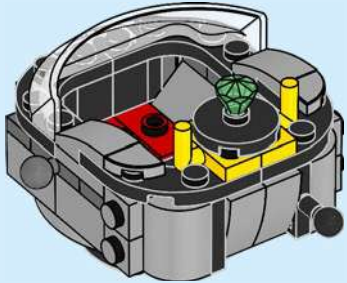

17

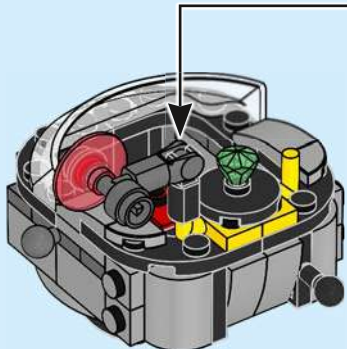
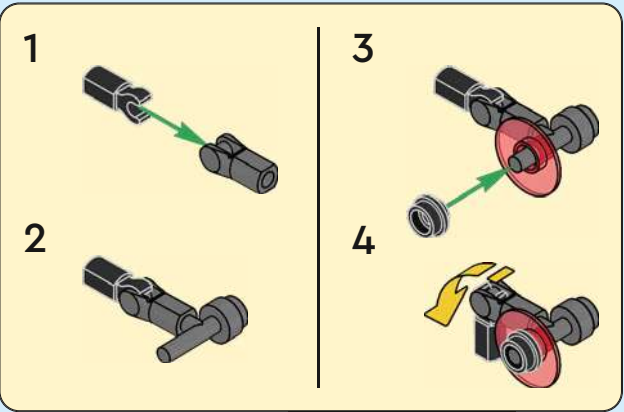



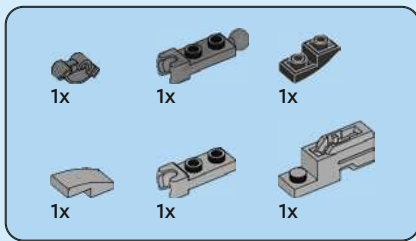

18

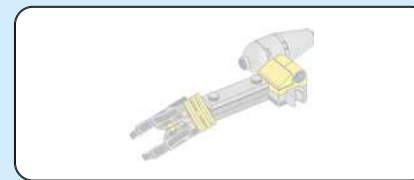
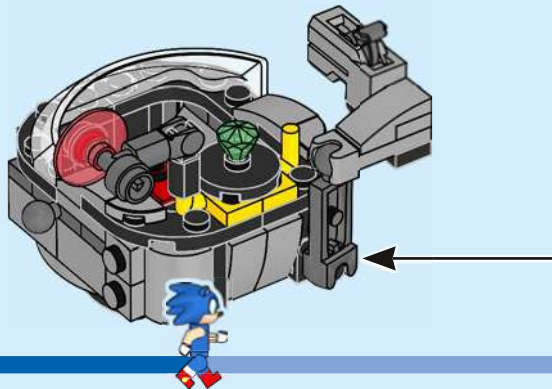
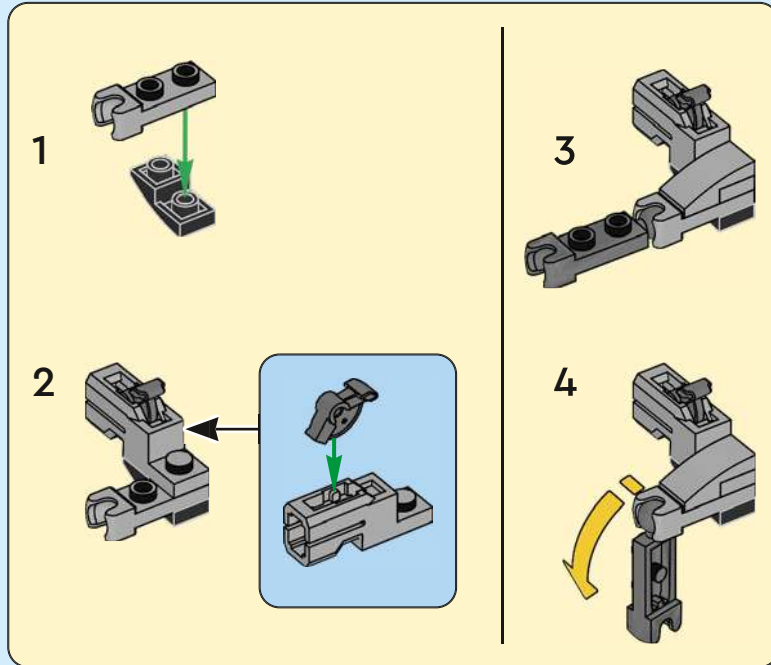

19

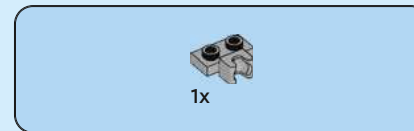
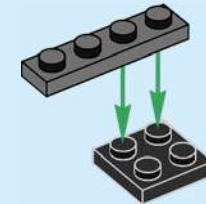

20

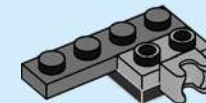

21

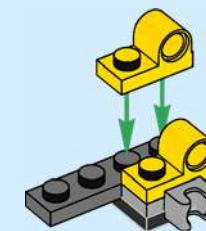

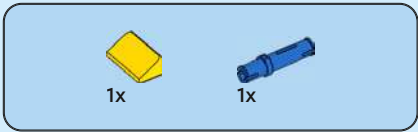

22

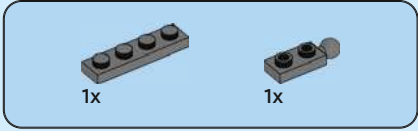
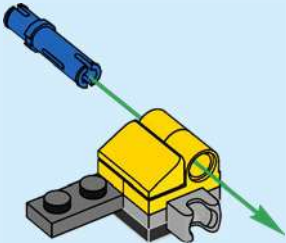

23

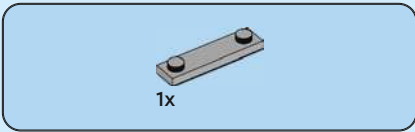
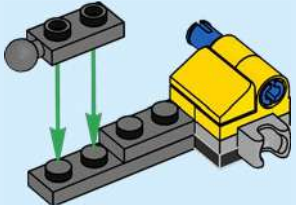

24

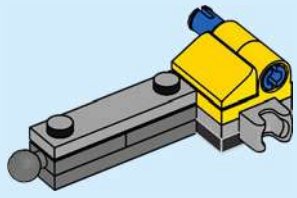

25

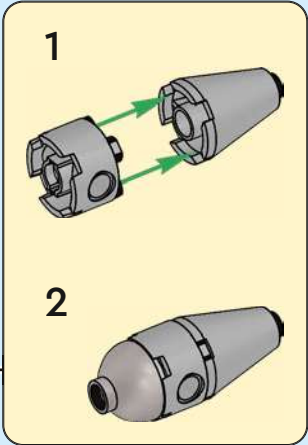
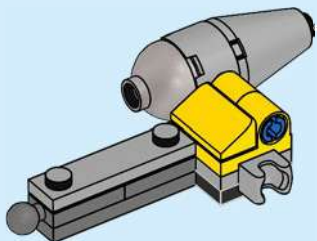

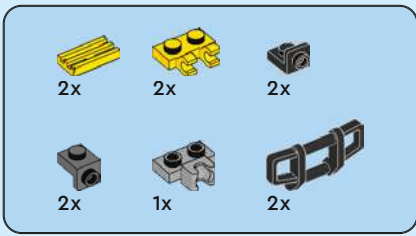

26

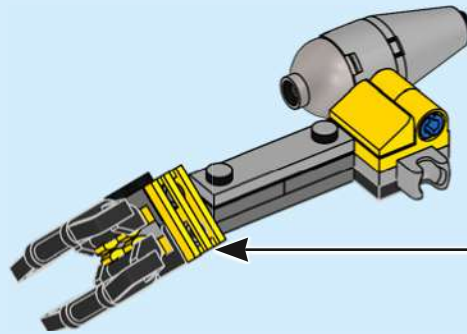
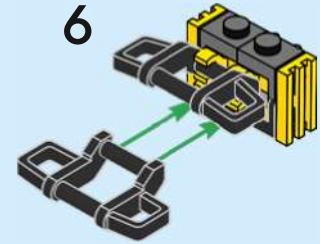
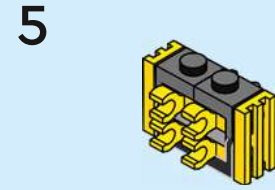
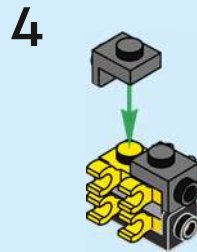
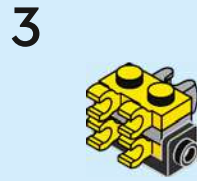
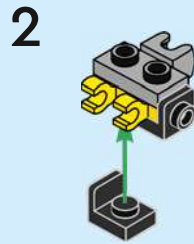
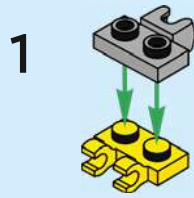

27

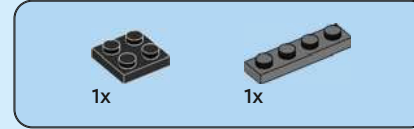
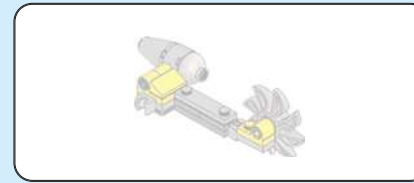
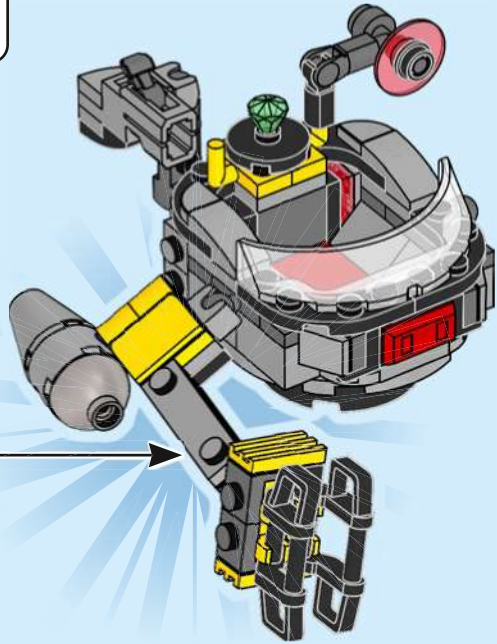

28

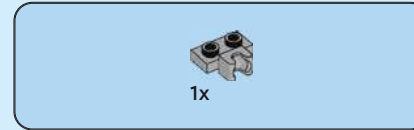

29



30

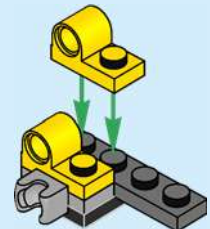
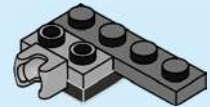
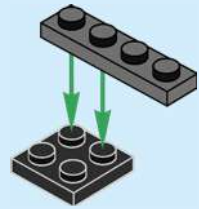

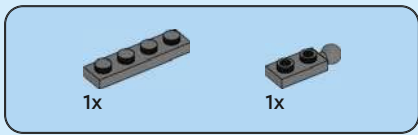

31

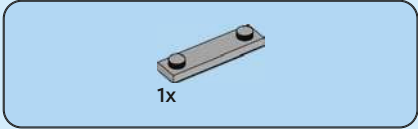
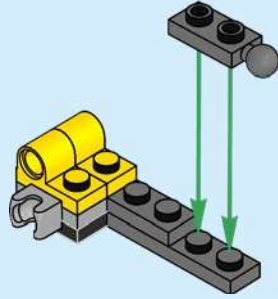

32

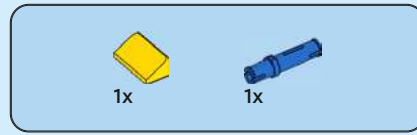
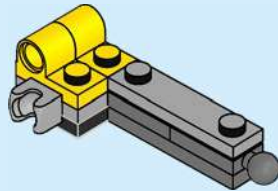

33

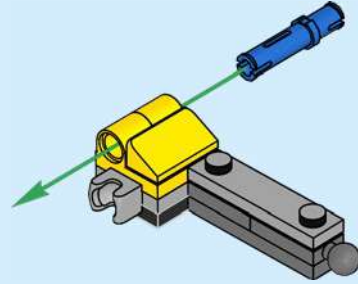

34

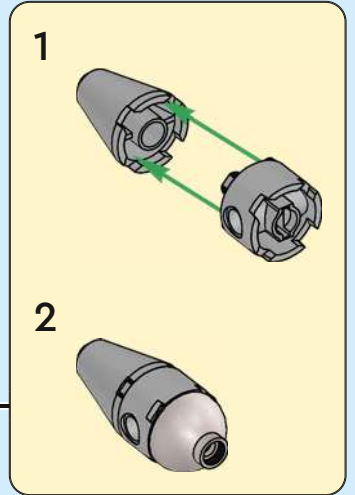
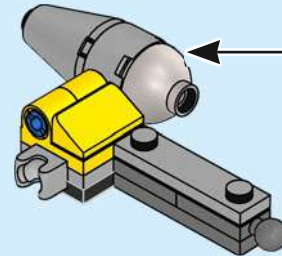



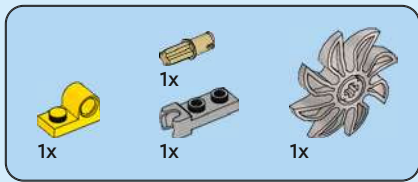

35

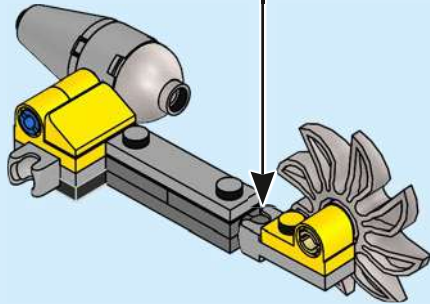
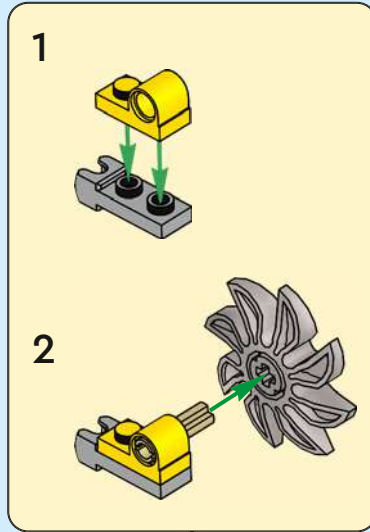

36

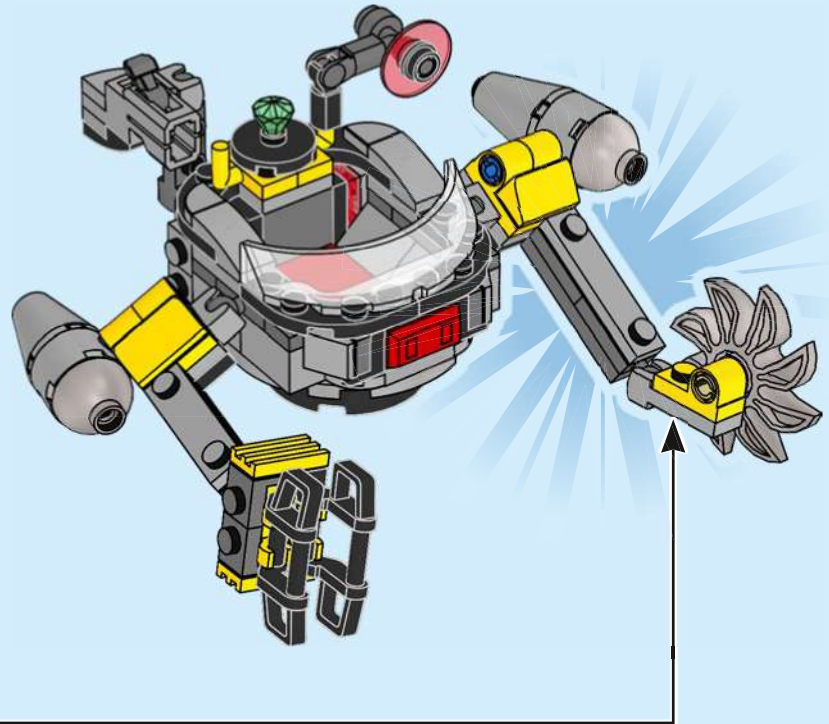

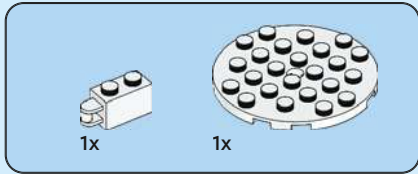
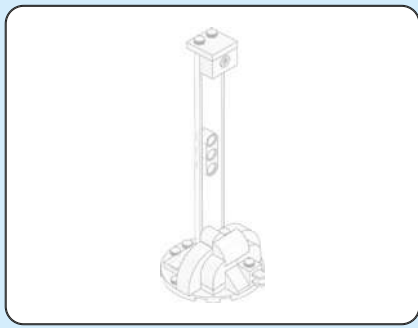

37

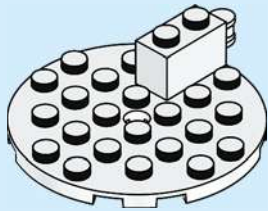

38

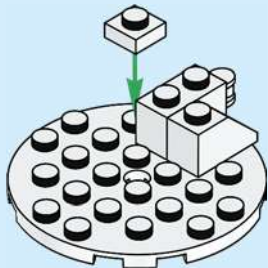

39

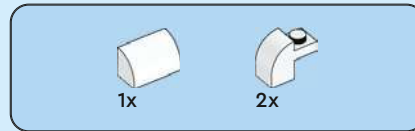
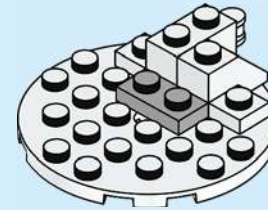

40

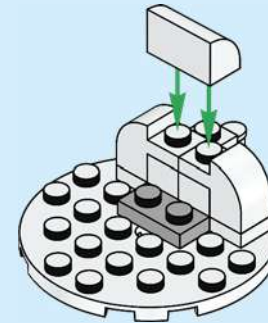

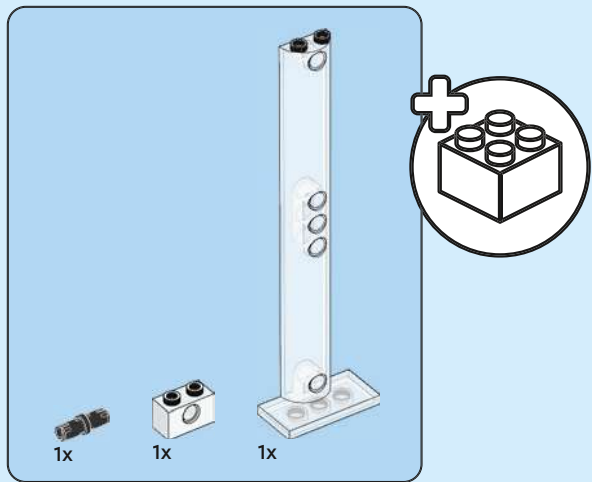

41

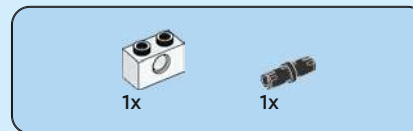
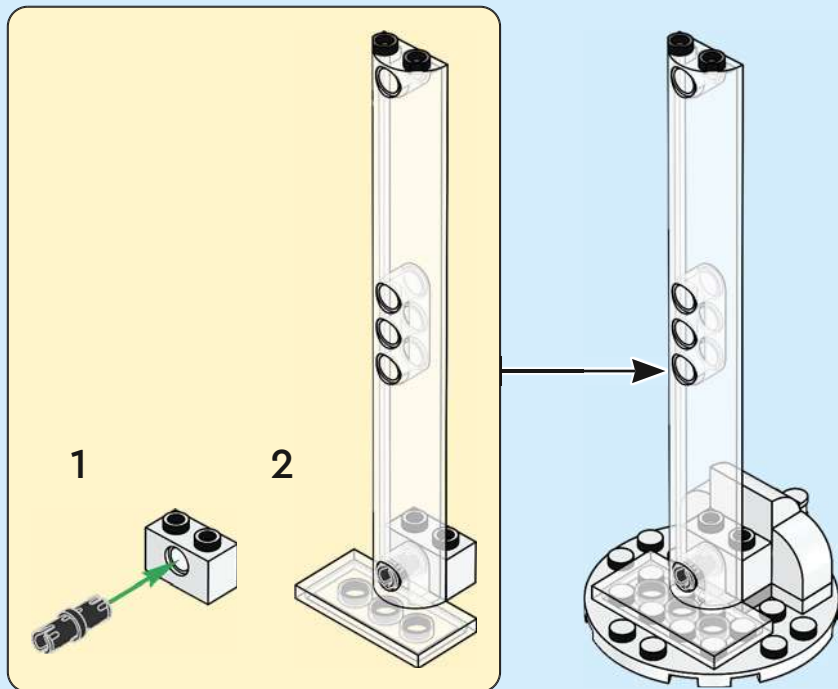

42

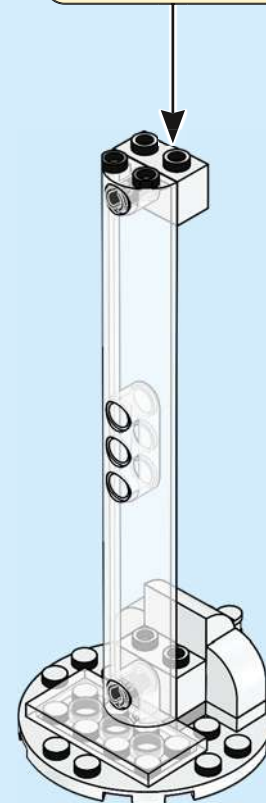
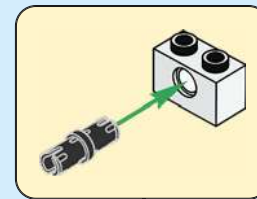



43

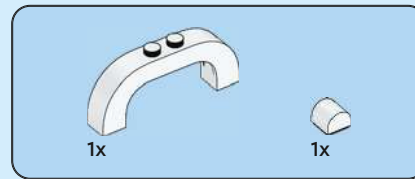
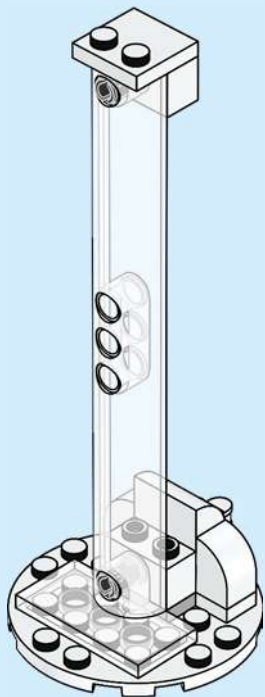

44

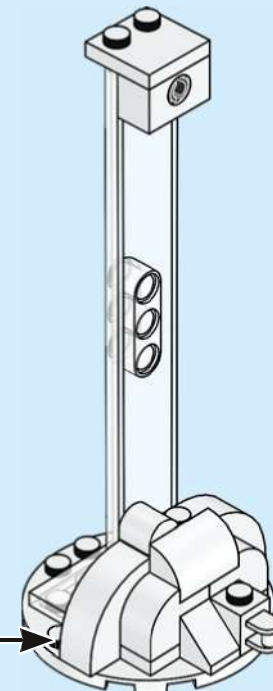
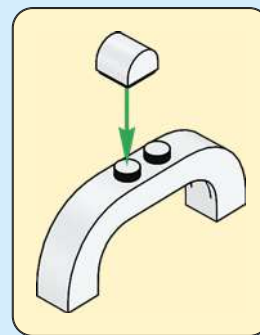

2x

45

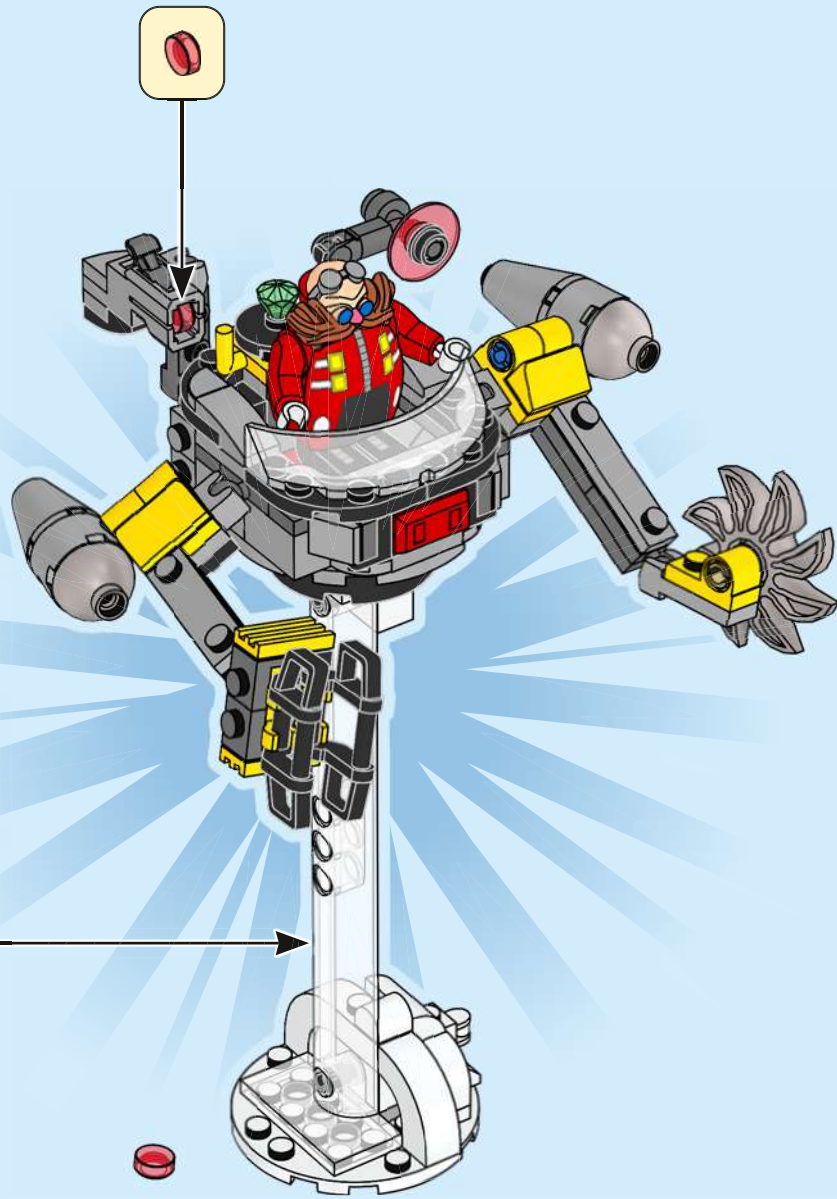



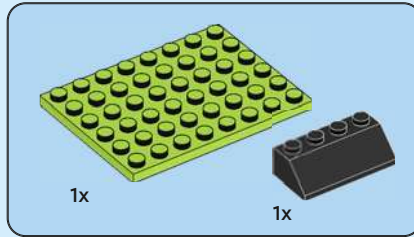
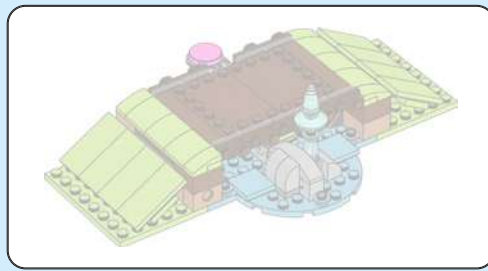

1

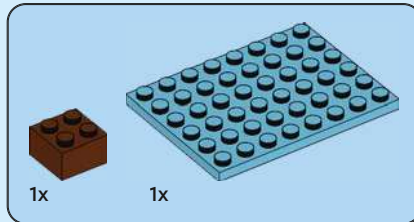
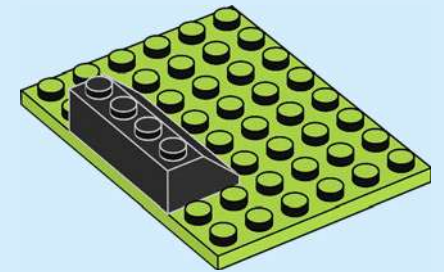

2

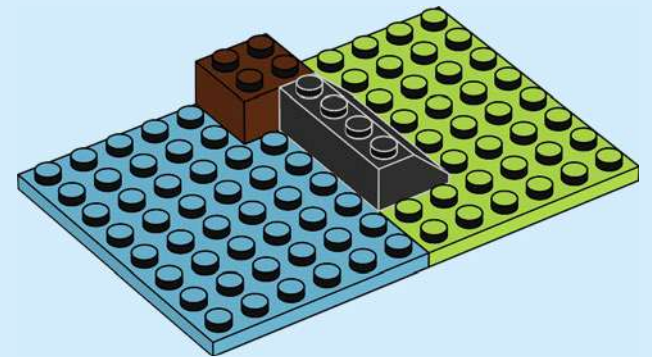

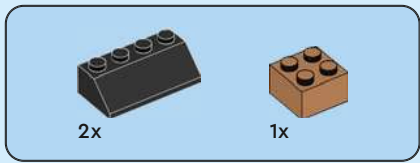

3

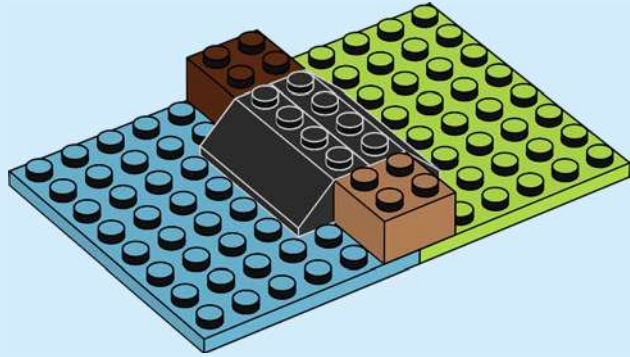

4

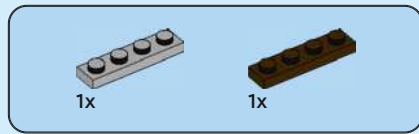
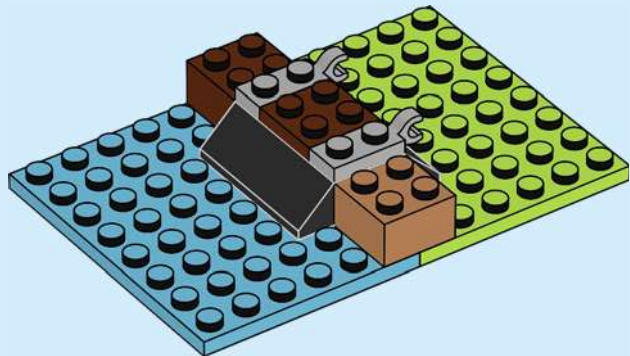

5

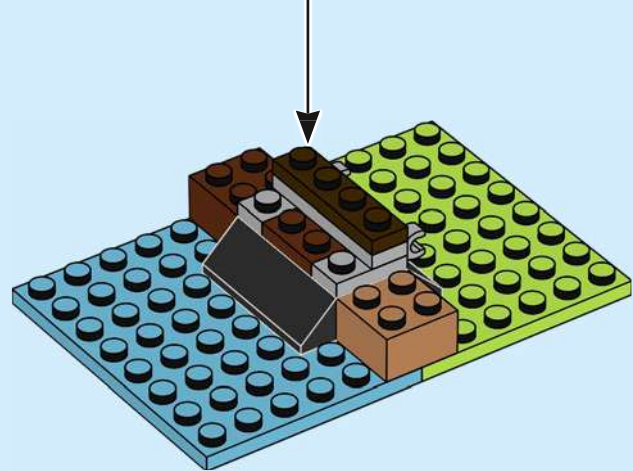
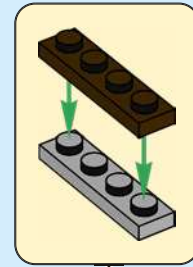

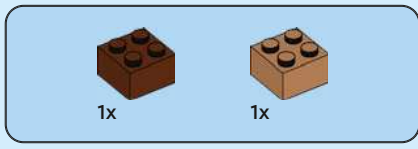

6

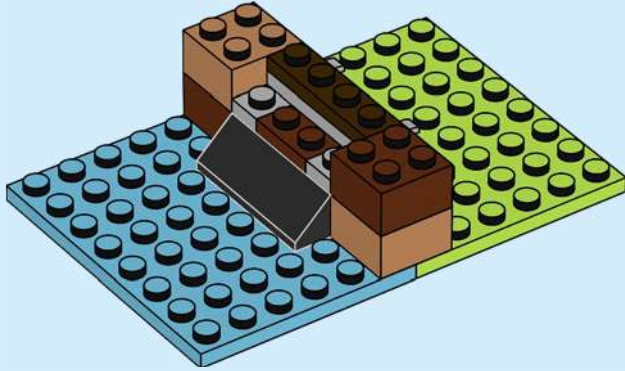

7

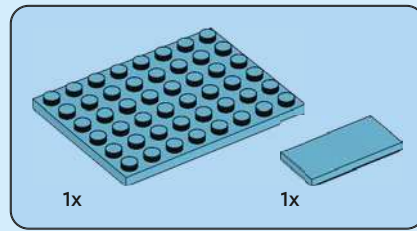
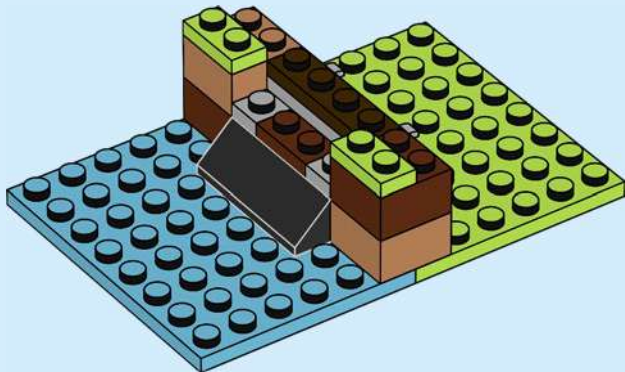

8

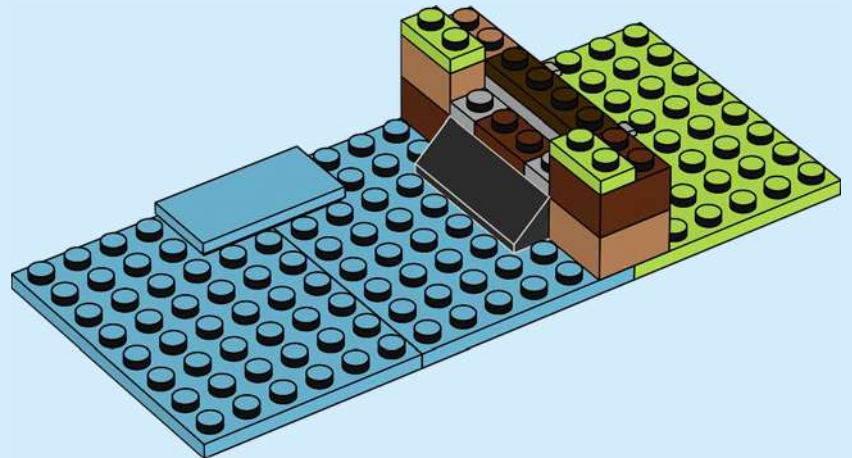



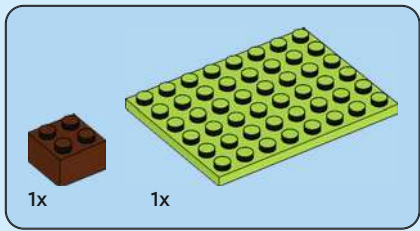

9

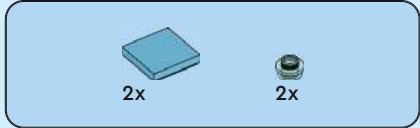
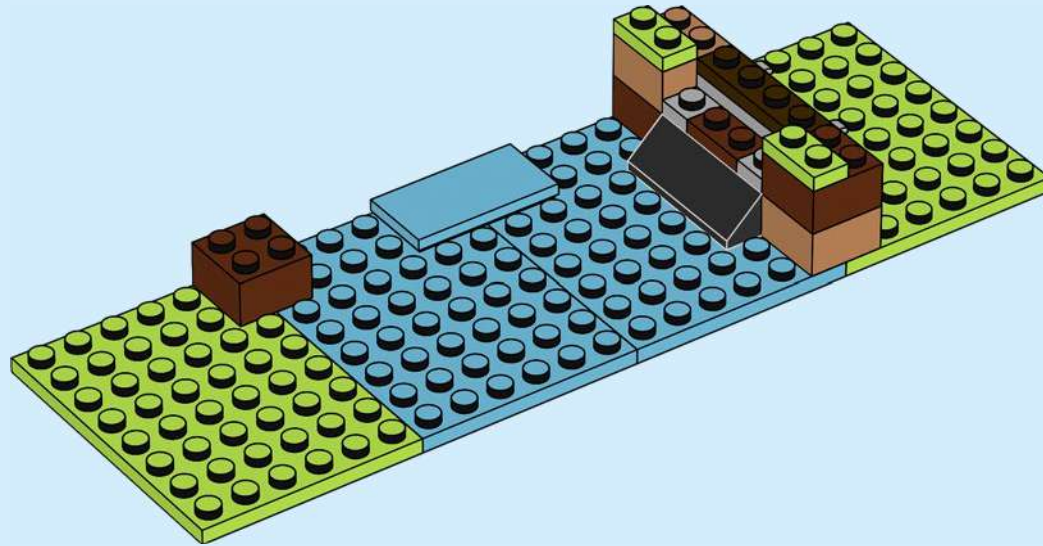

10

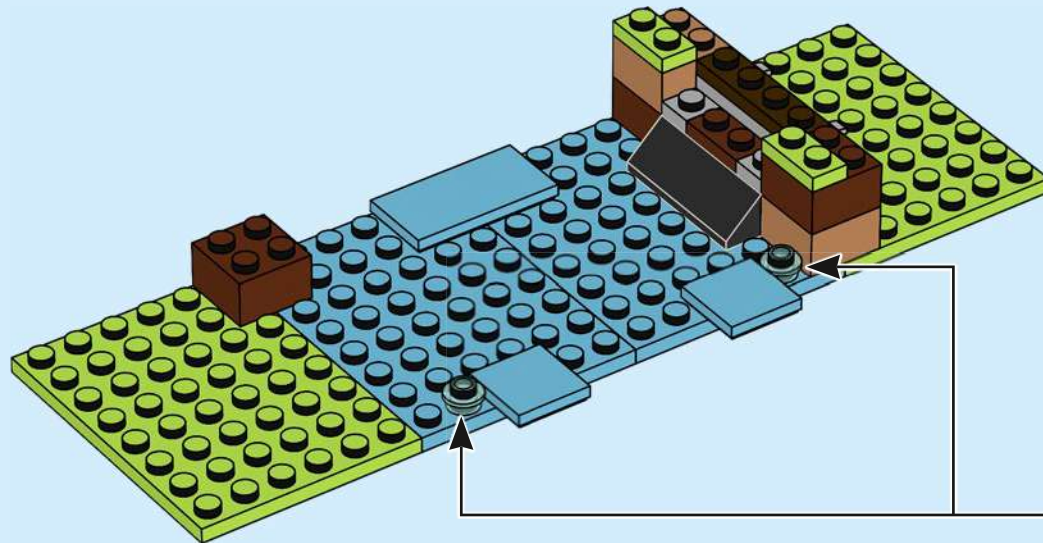

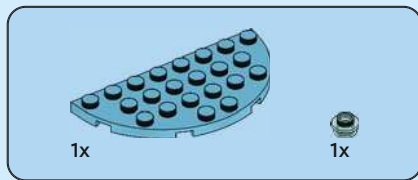

11

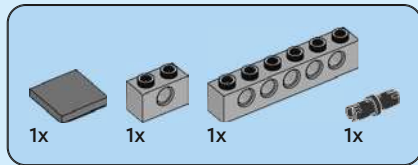
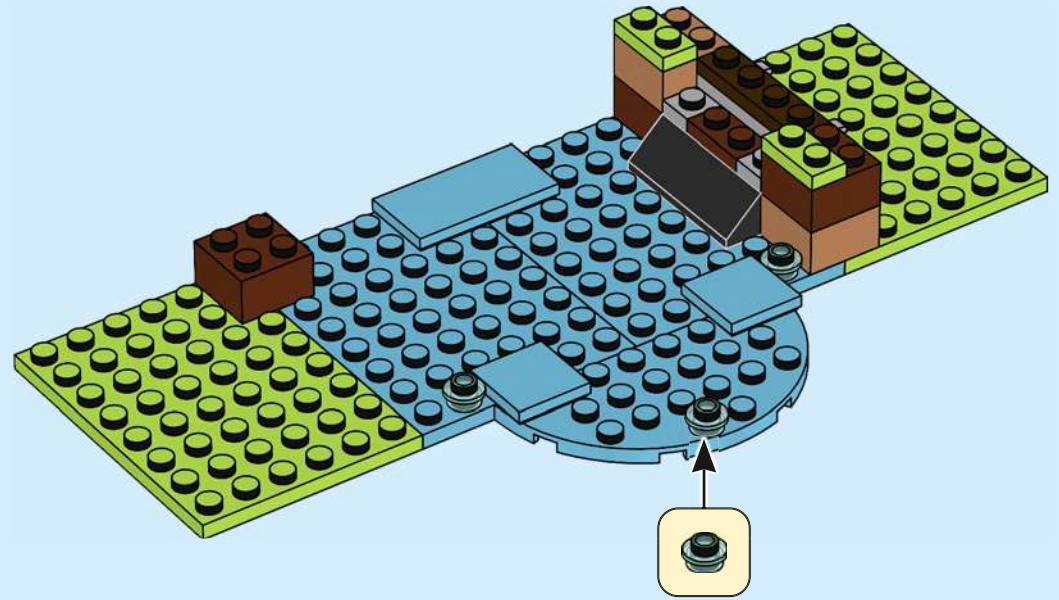

12

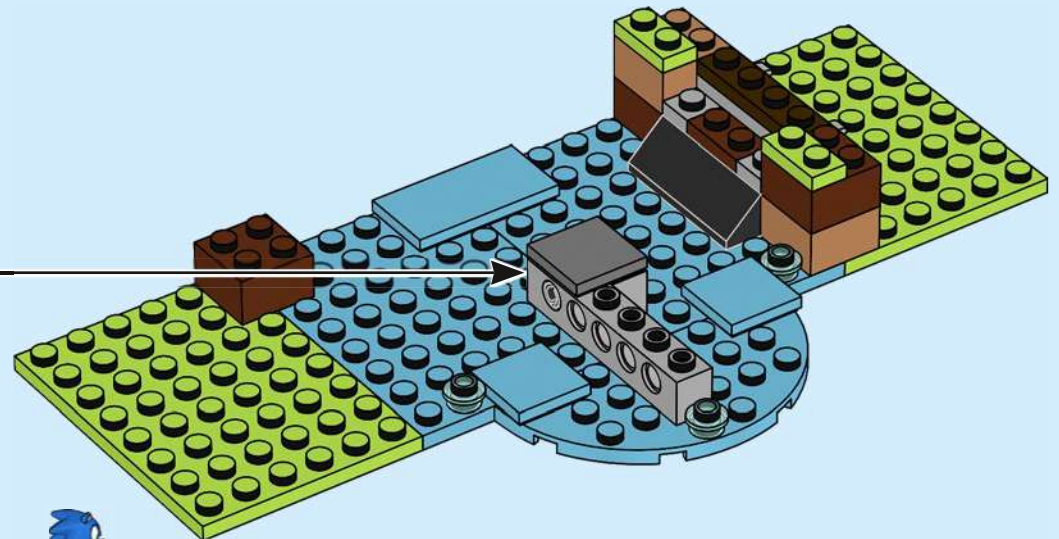
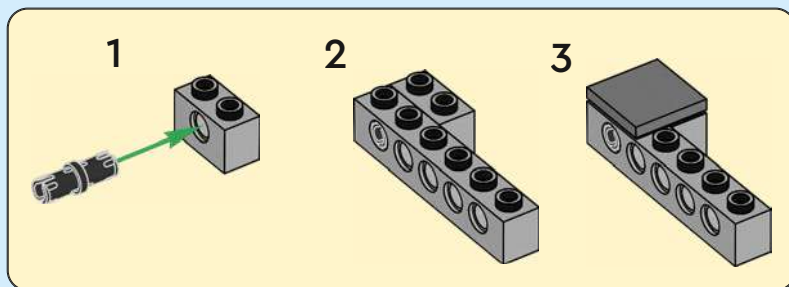



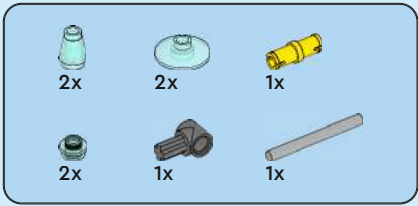

# 13

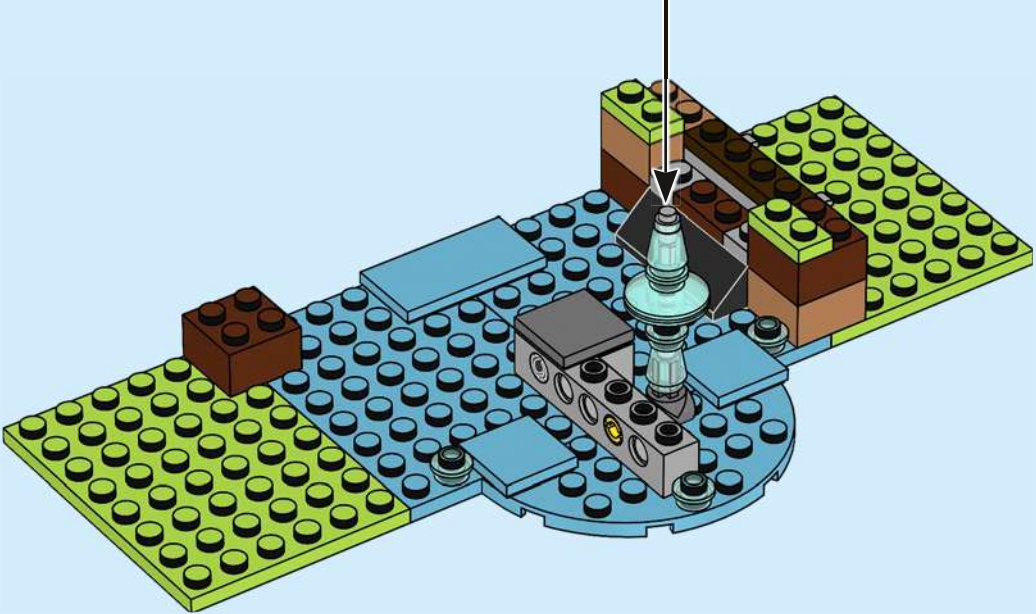
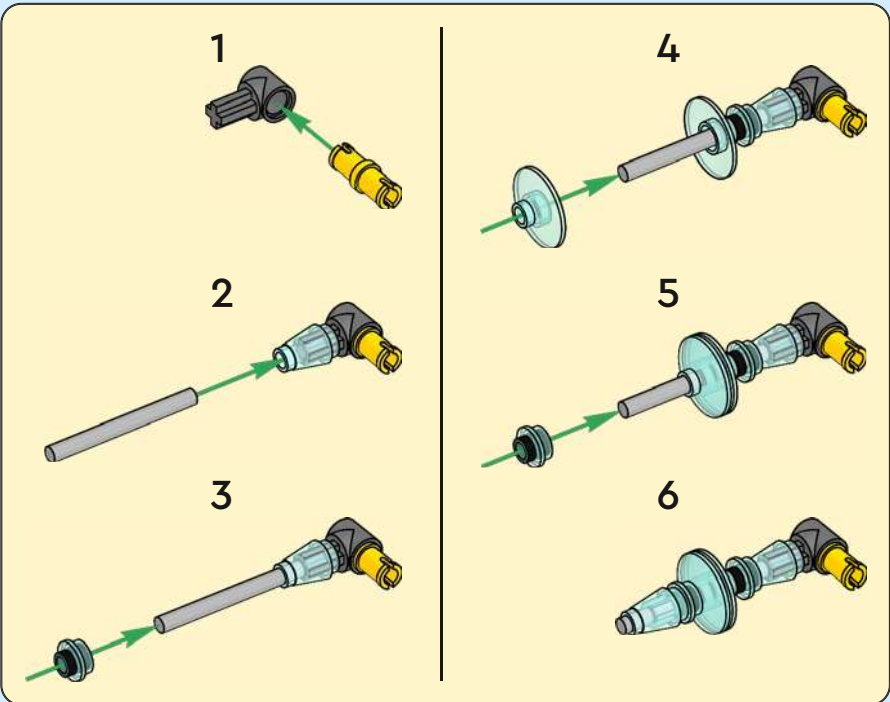

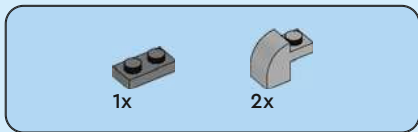

14

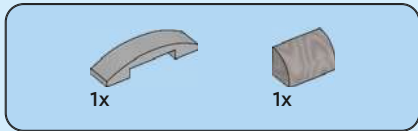
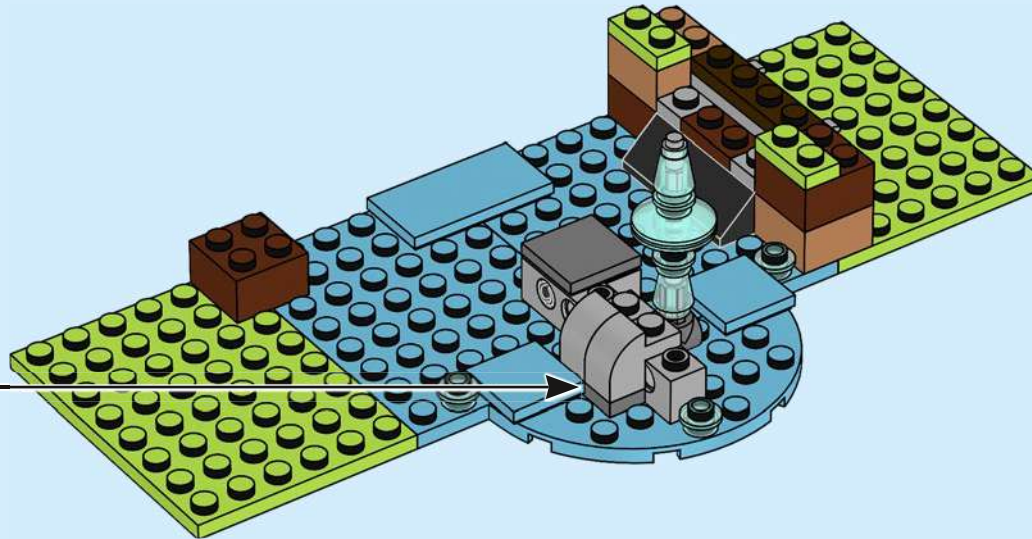
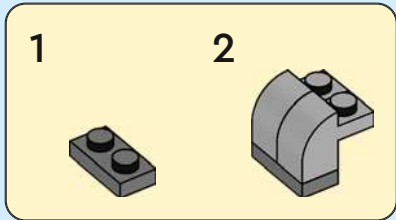

15

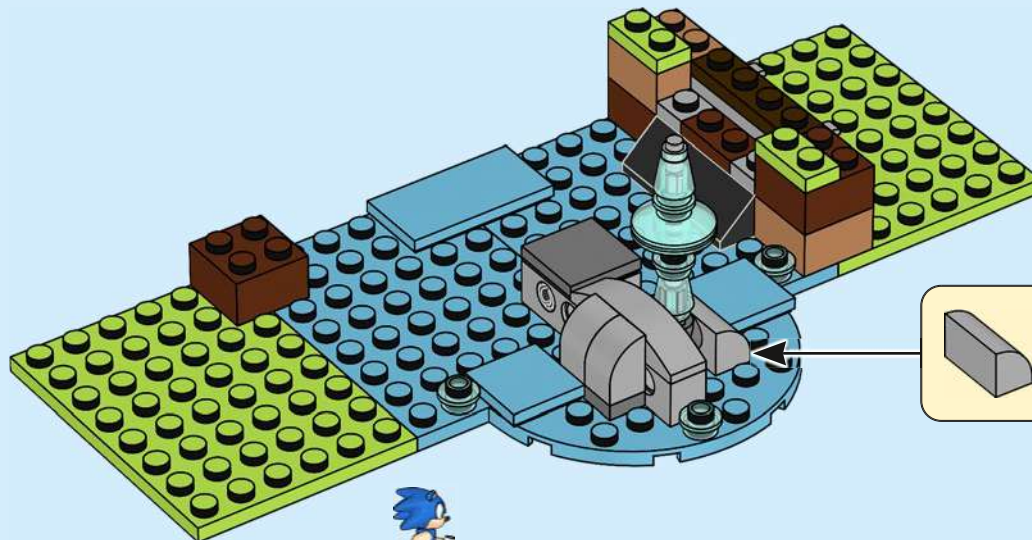







18

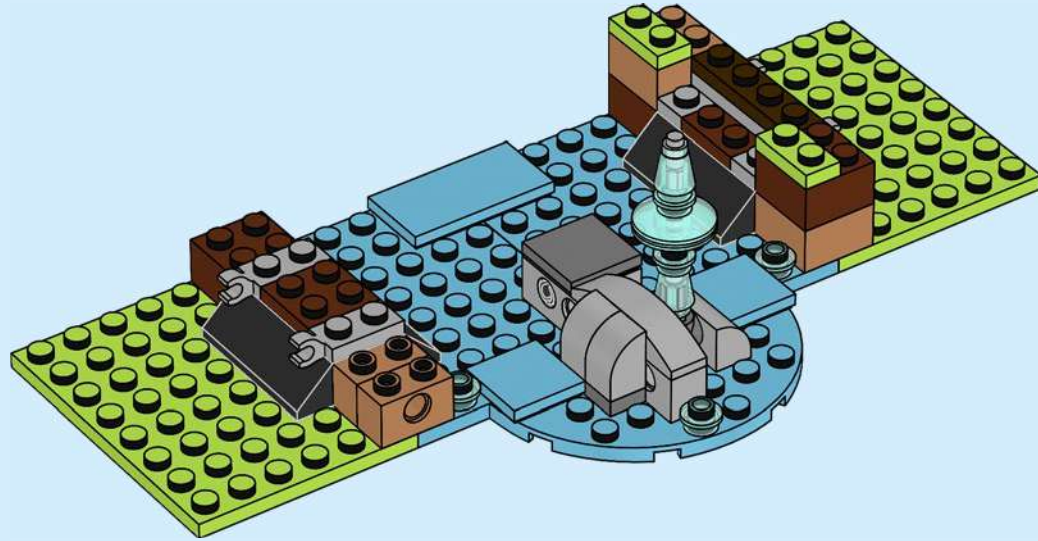

19

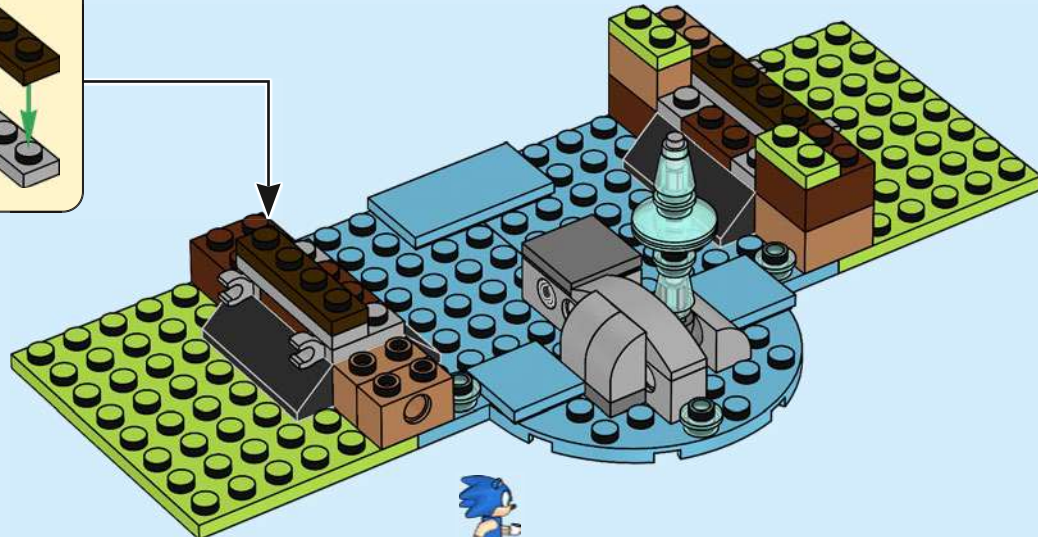
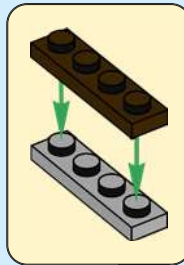





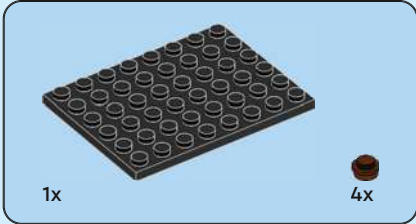
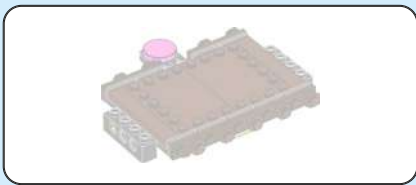

22

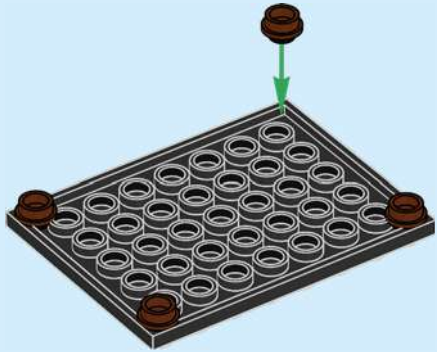

23

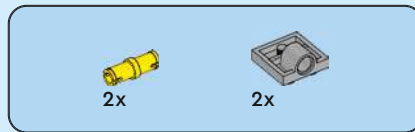
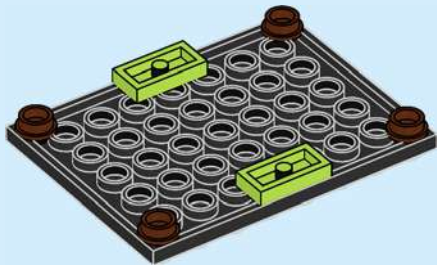

24

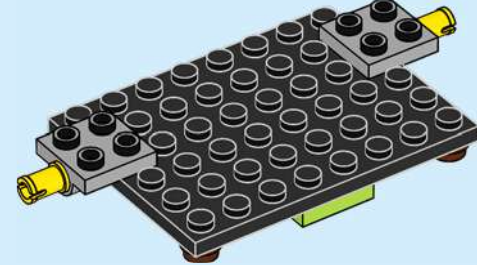
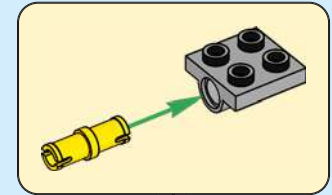

25

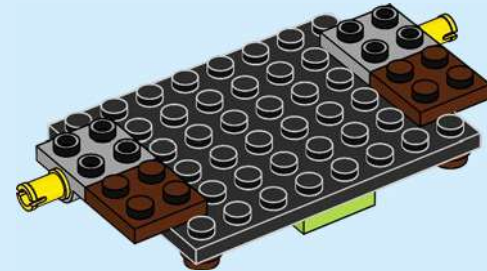



26

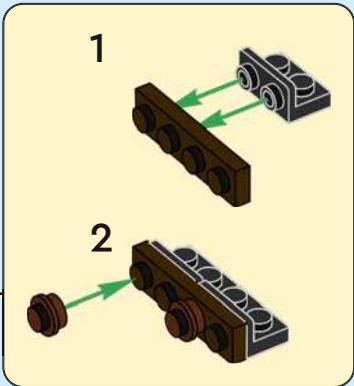
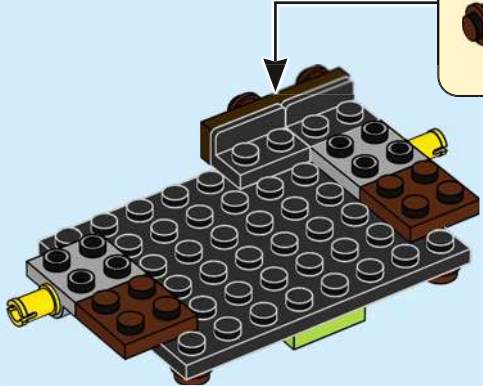

27

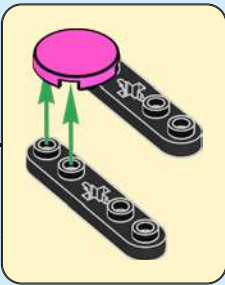
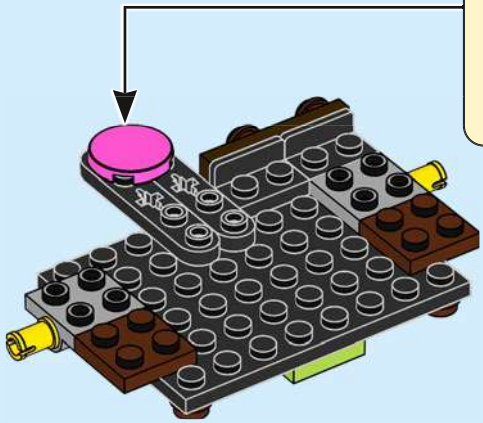

28

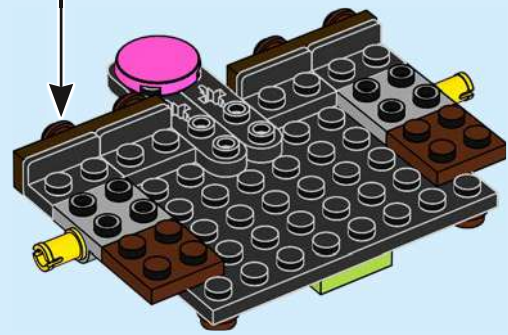
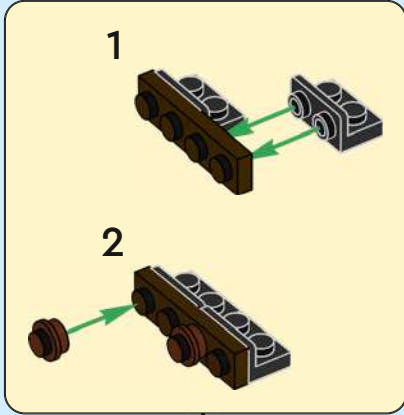

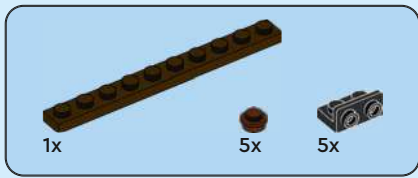

29

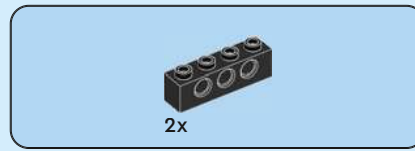
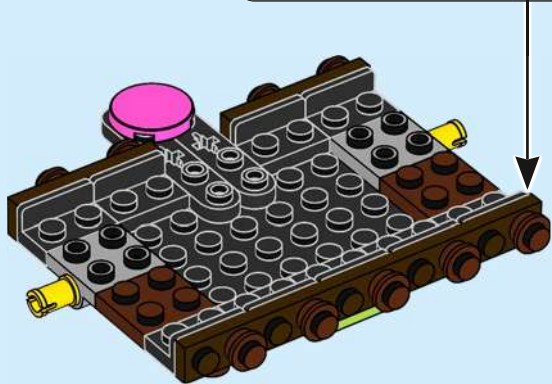
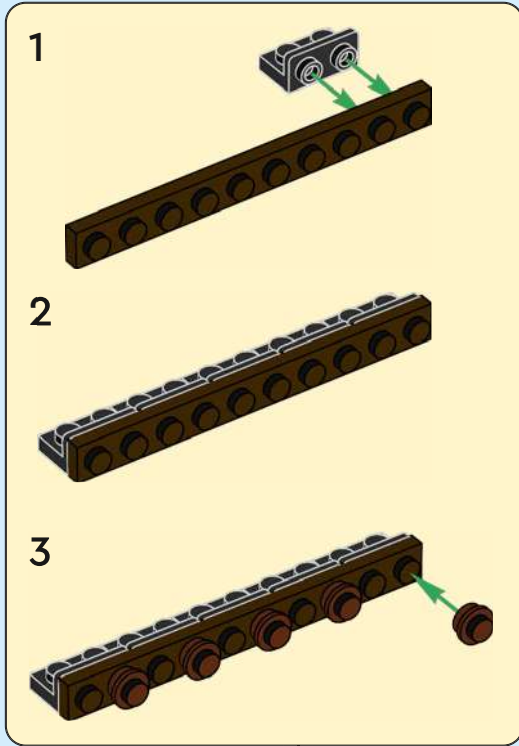

30

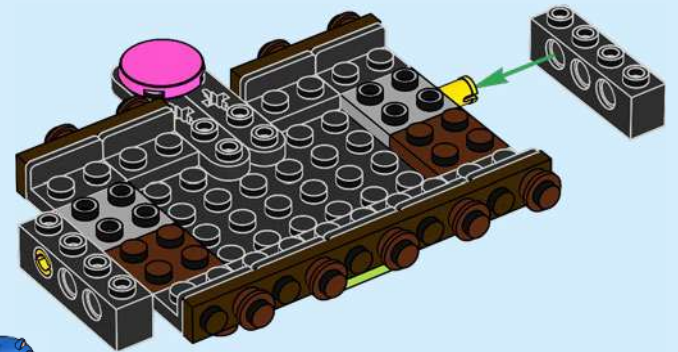



2x

31

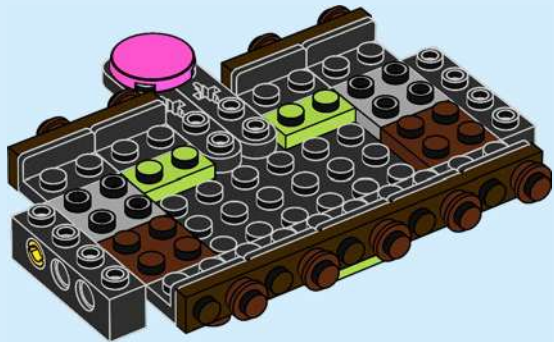

2x



2x

32

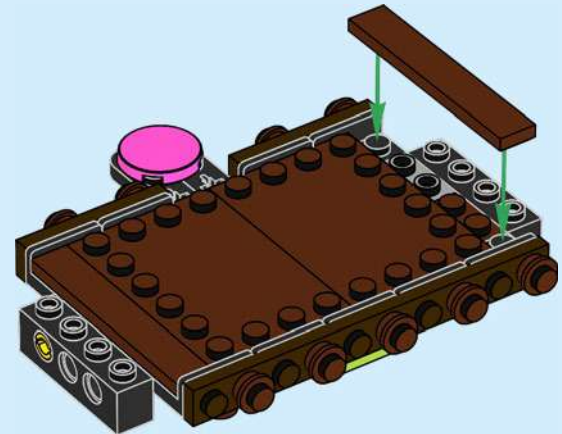



33

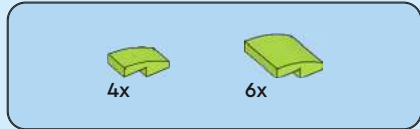
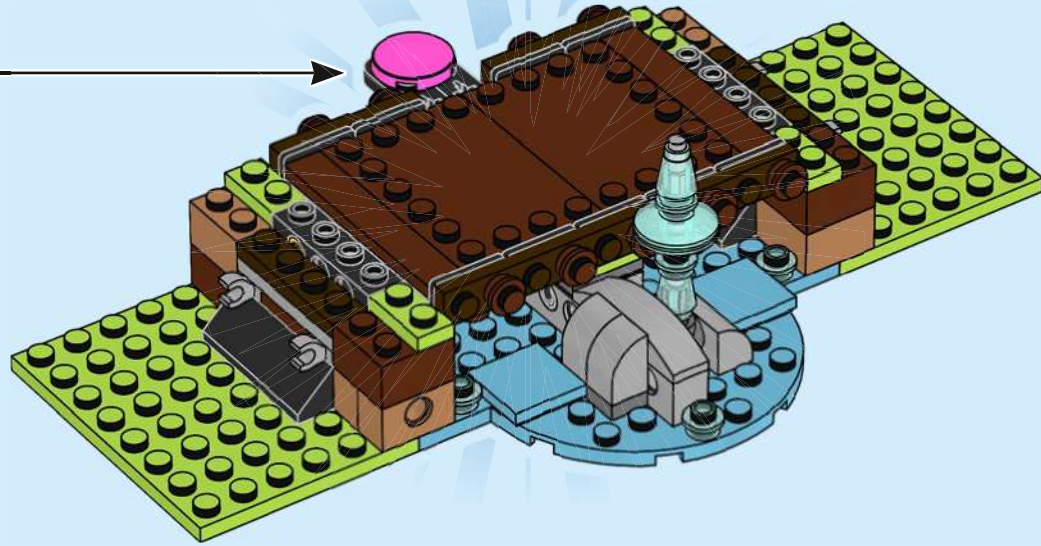

34

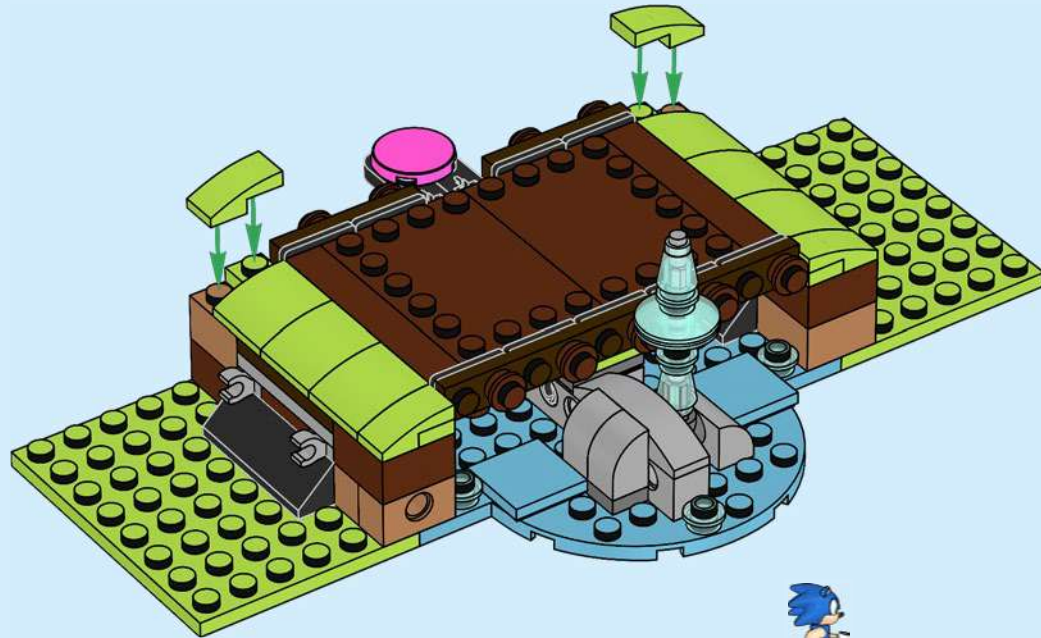



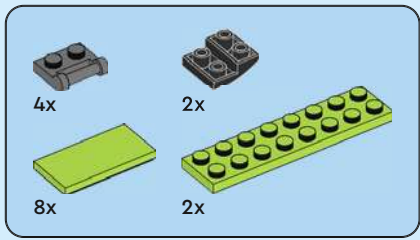

35

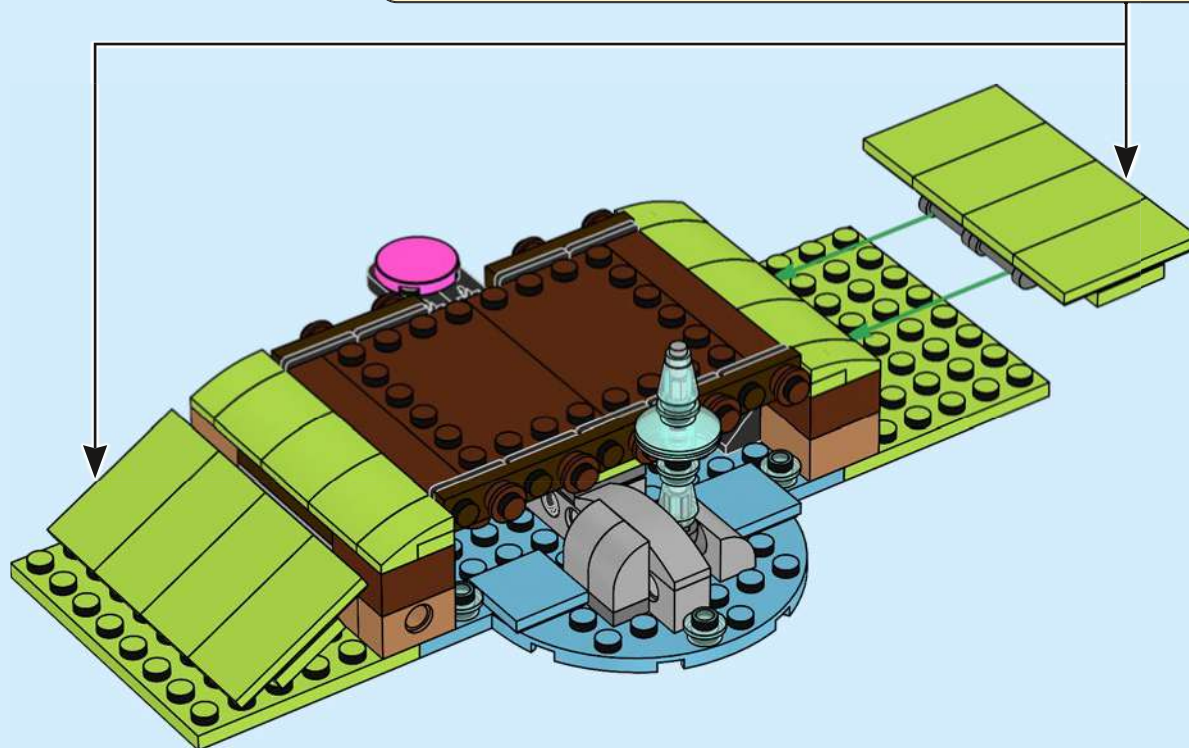
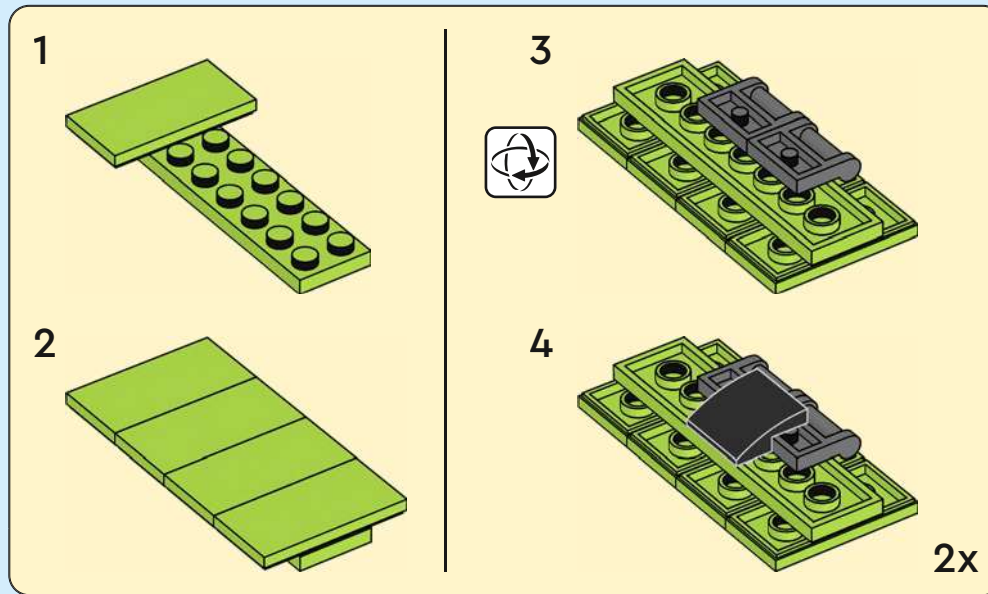

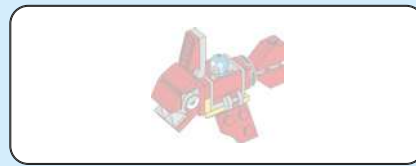

36

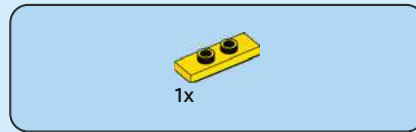

37





2x

# 38



2x

# 39

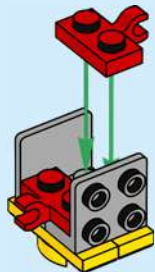

2x

# 40

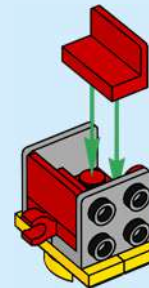

1x



1x

# 41

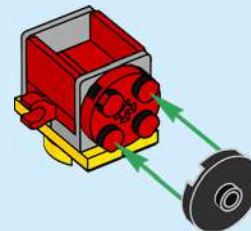

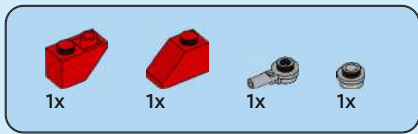

42

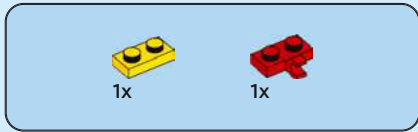
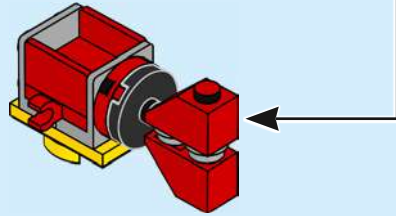
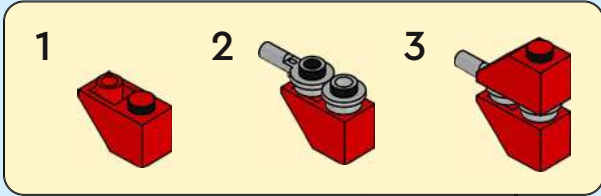

43

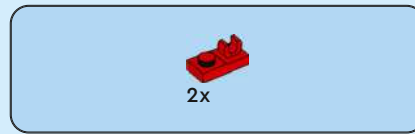
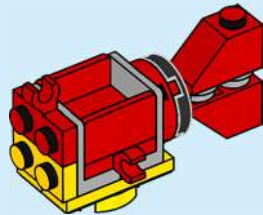

44

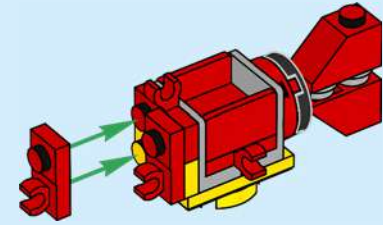

45

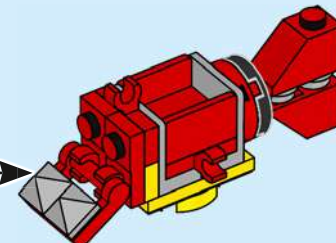
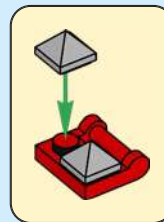



46

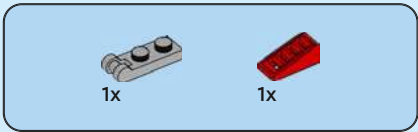
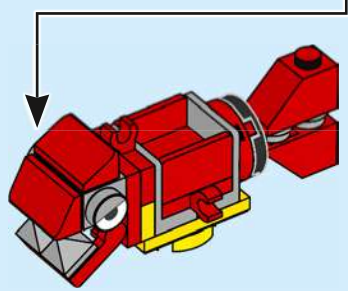
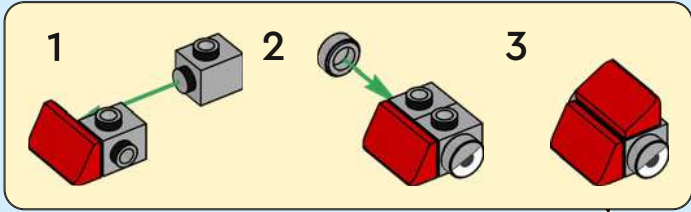

47

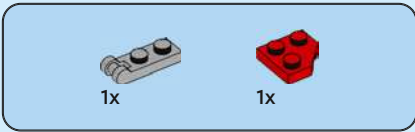
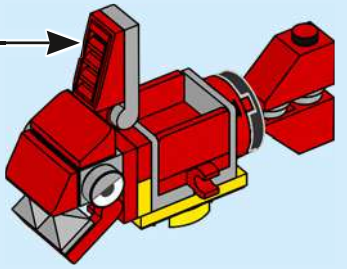
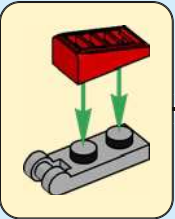

48

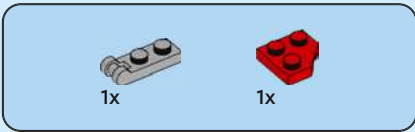
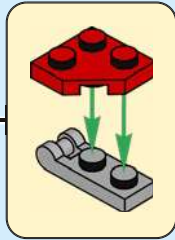
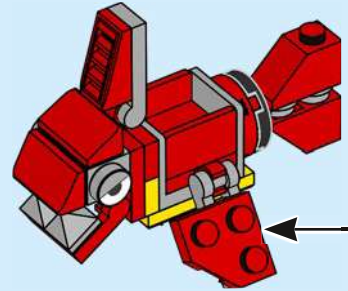

49

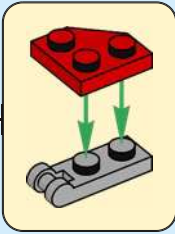
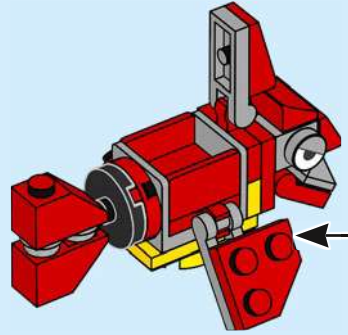
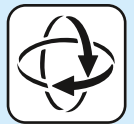





1x

50

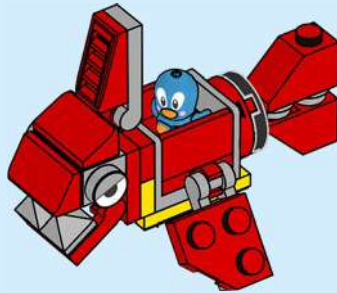

51

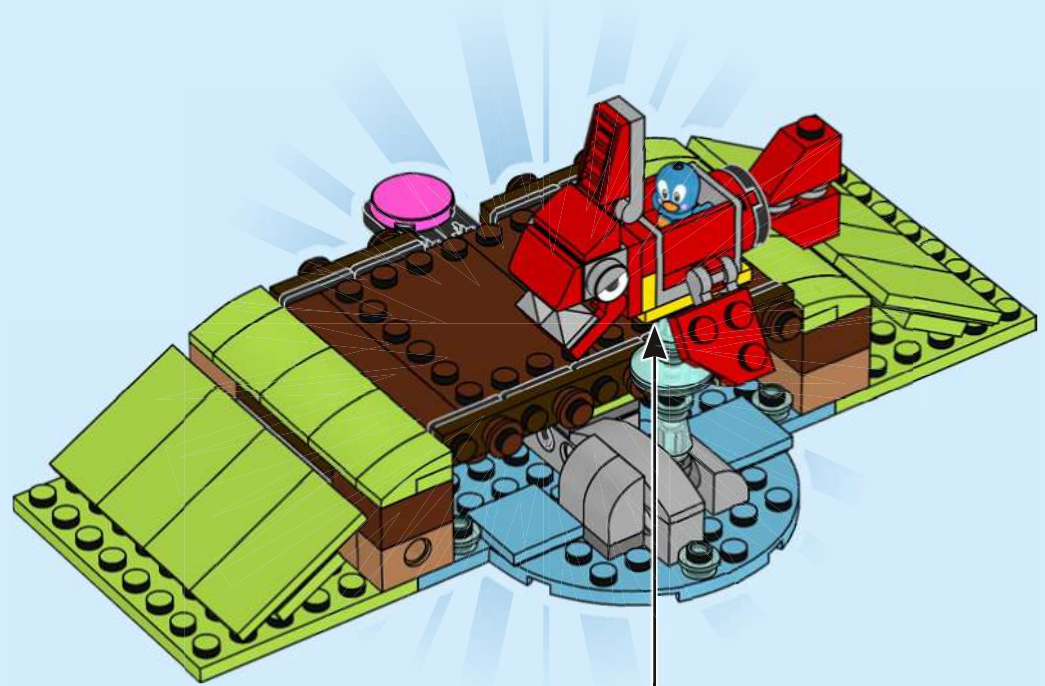

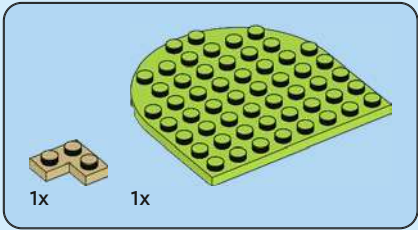
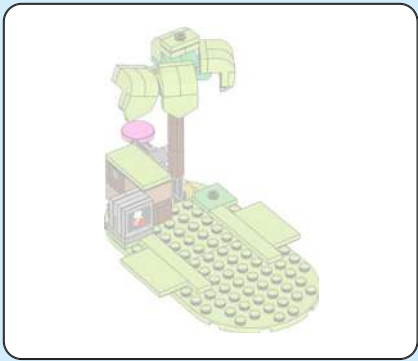

1

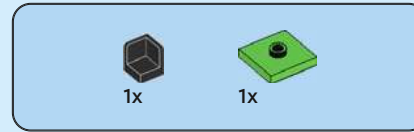
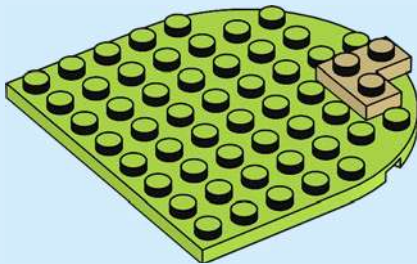

2

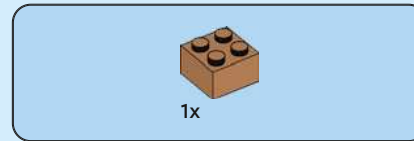
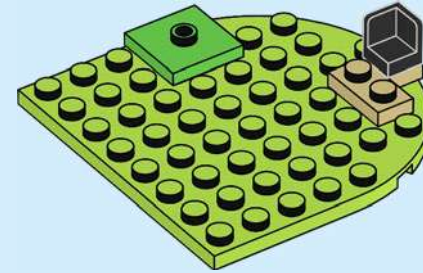

3

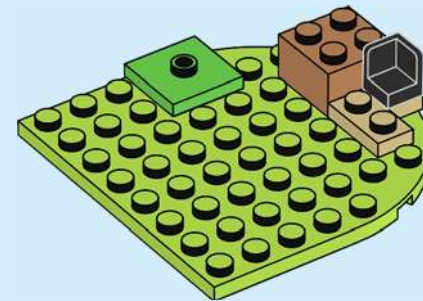

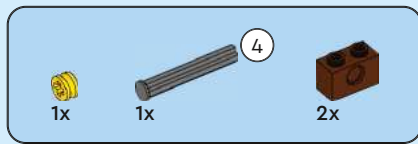

4

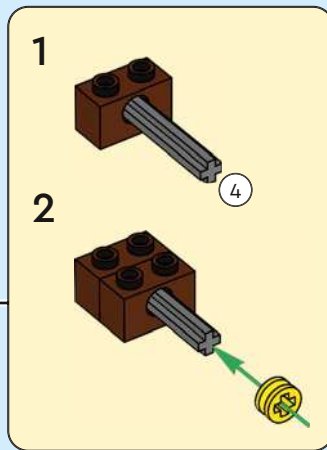
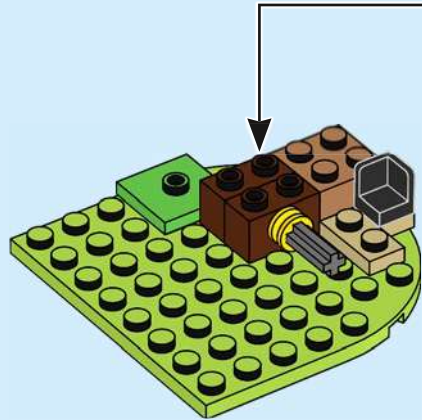

5

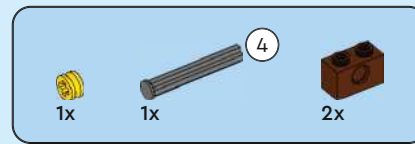
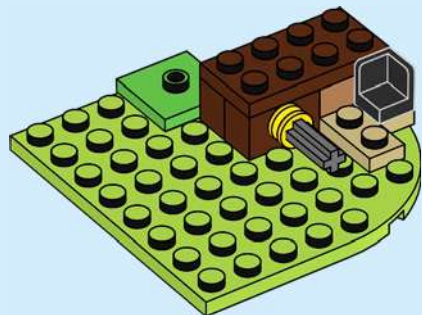

6

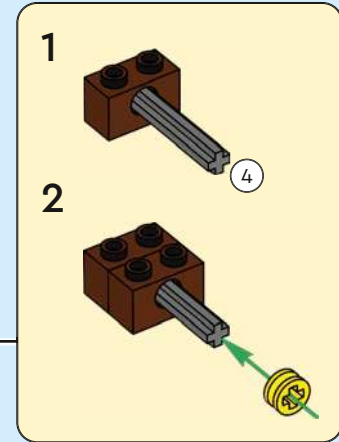
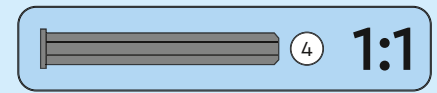
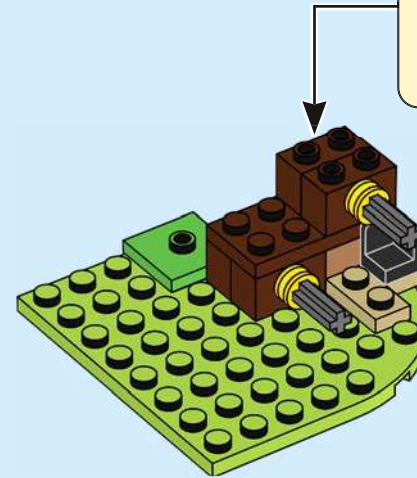

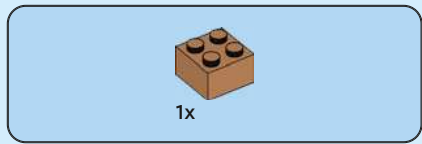

7

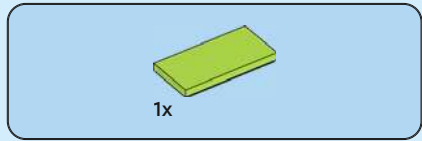
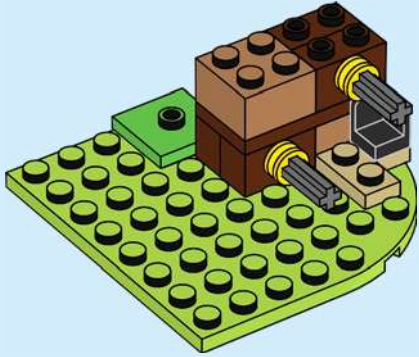

8

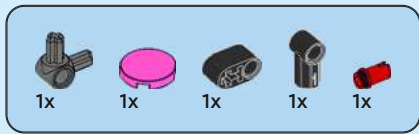
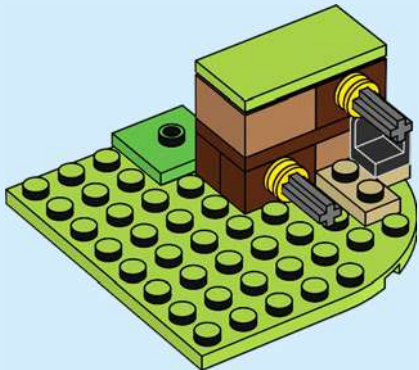

9

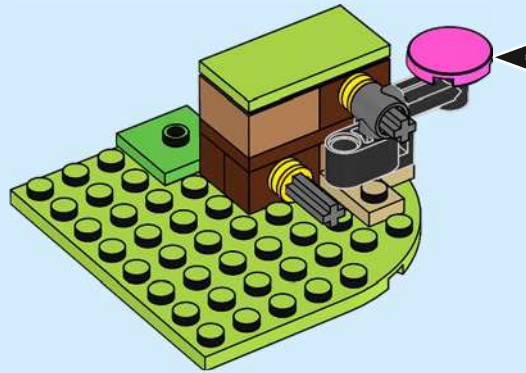
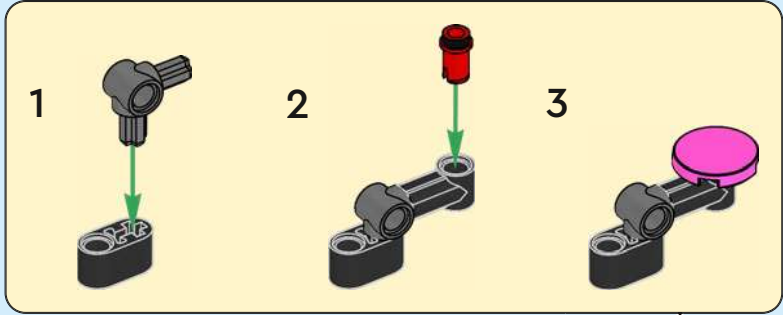



10

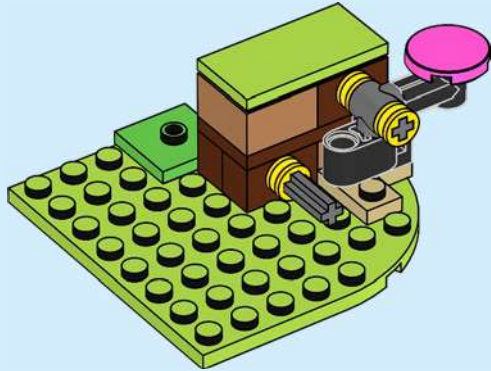

11

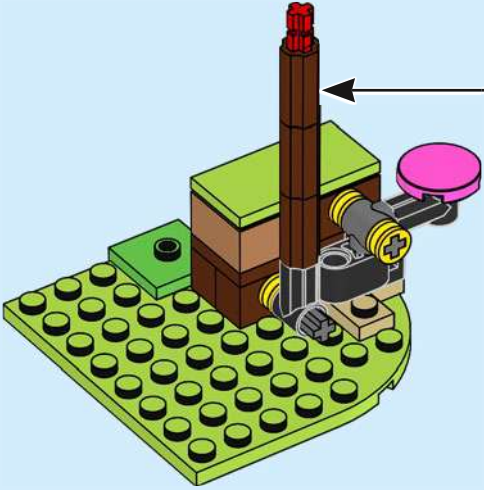
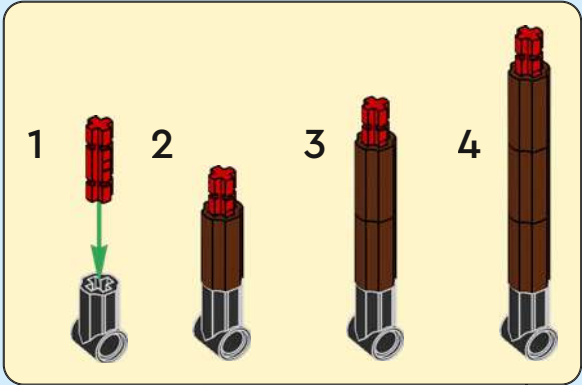





1x

12



1x

13



1x



2x



1x



1x



1x



1x

14

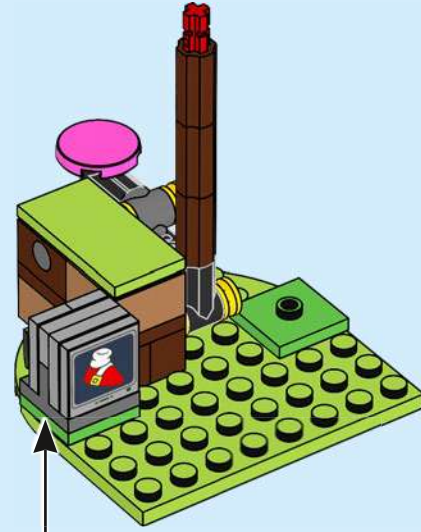

1

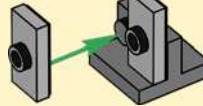

2

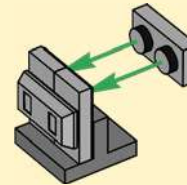

3

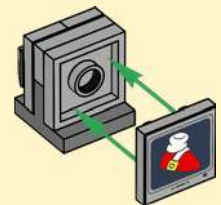

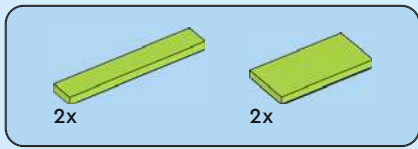

15

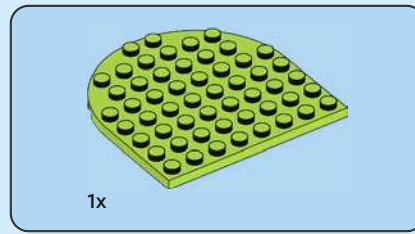
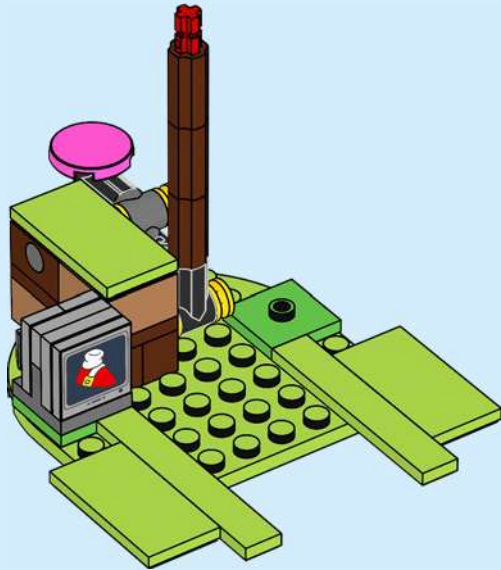

16

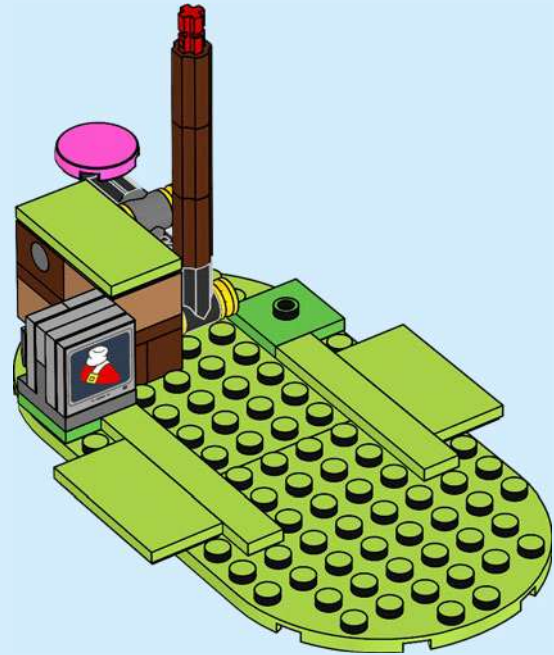

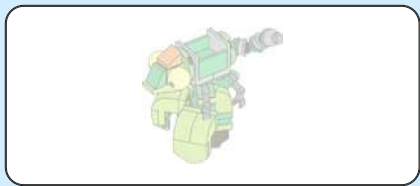

17



18



19



20



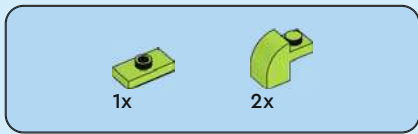

21

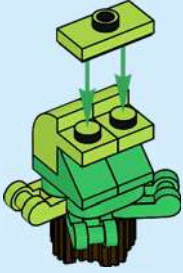

22

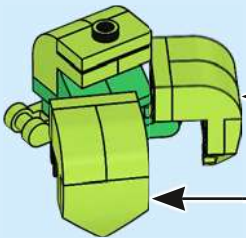
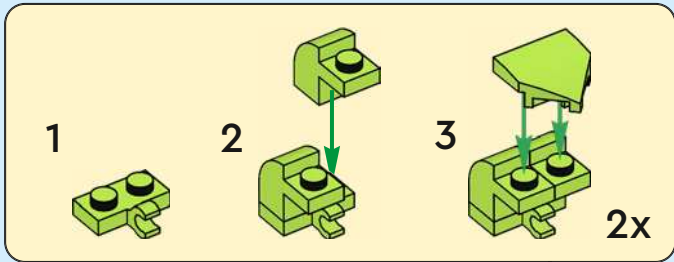

23

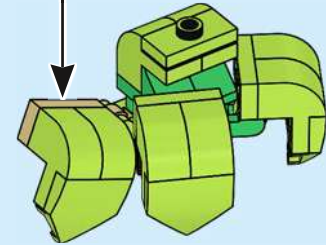
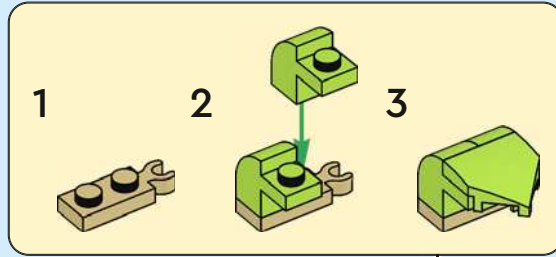

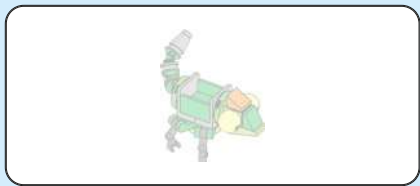

24

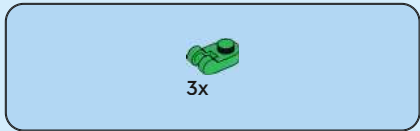

25

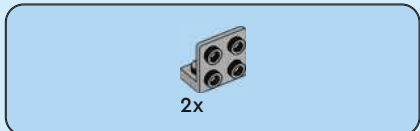

26

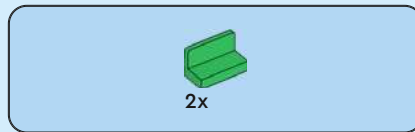

27



28

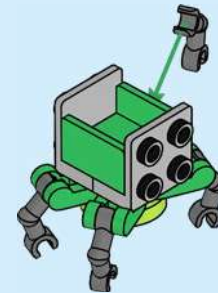



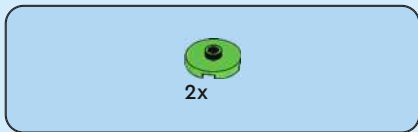

29

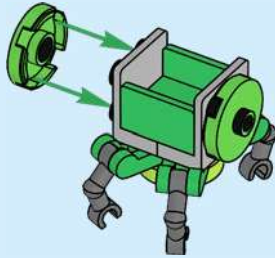

30

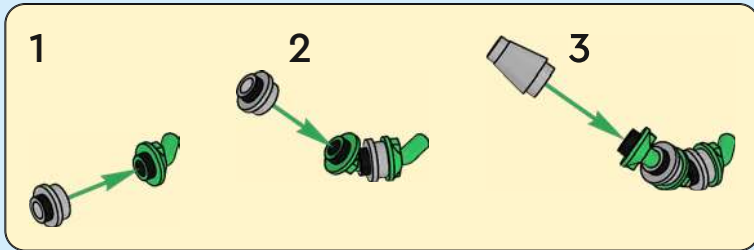

31

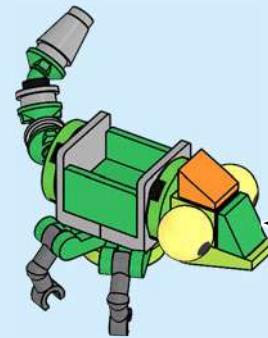
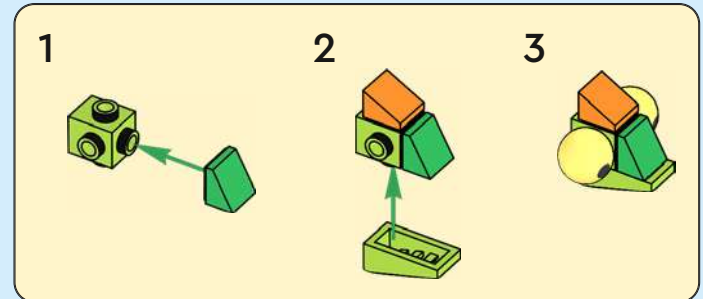

32

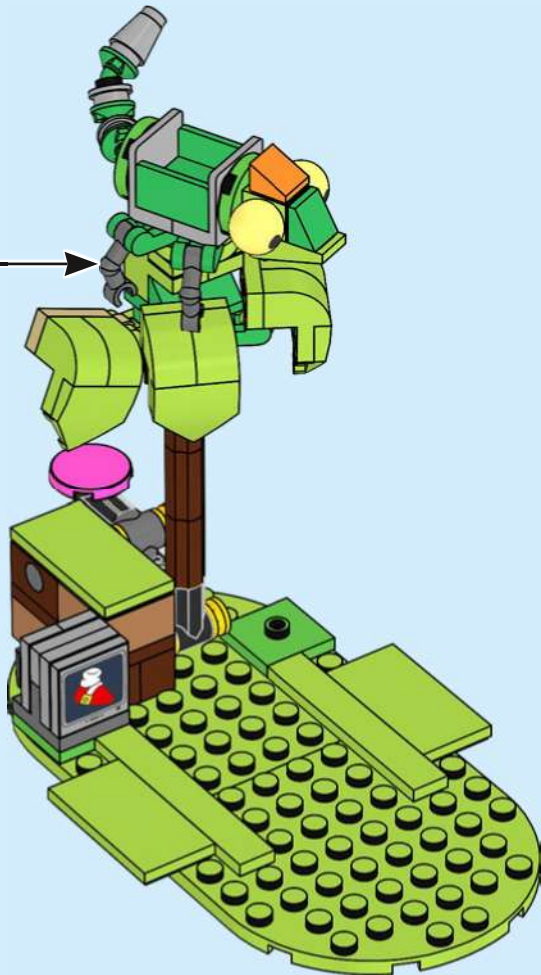

1x

A small icon of a brown bear-like character is shown inside a light blue rounded rectangle. Below the icon, the text "1x" indicates the quantity of this part required for the step.

33

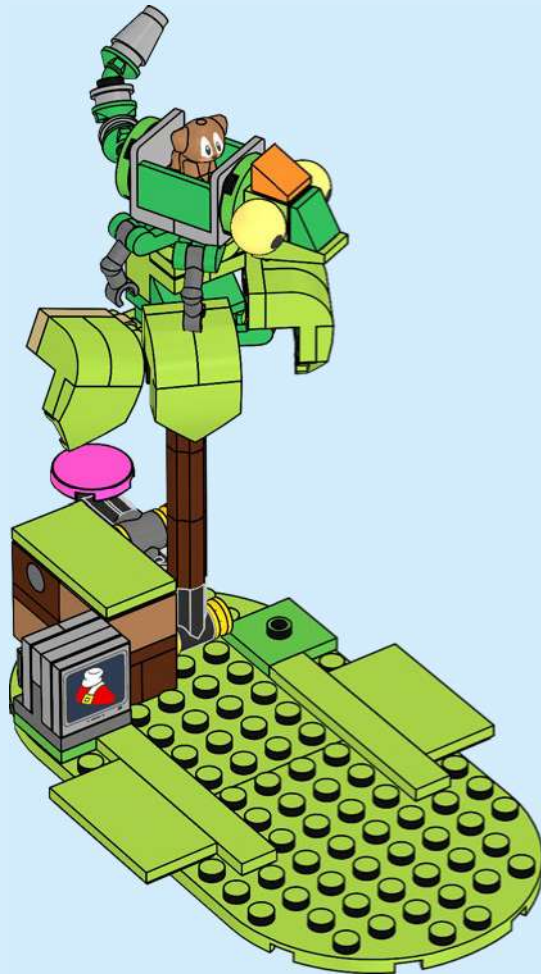







# SONIC™

THE HEDGEHOG



## Combine sets to expand your play!



Combine sets to expand your play!  
Kombiniere Sets für noch mehr Spielspaß!  
Combine les niveaux pour étendre ton expérience de jeu !  
Combina i set per espandere il tuo gioco!  
¡Combina sets para jugar mucho más!  
Combina sets para expandir os teus momentos de diversão!  
组合系列套装, 增强玩乐体验!  
Łącz zestawy i baw się jeszcze lepiej!  
Kombinujte stavebnice a rozšířte svou hru!  
Kombinujte stavebnice a rozšířte herné možnosti!  
A készletek egyesítésével bővítsd a játékot!  
Combină seturi pentru a-ți extinde joaca!  
Комбинируйте комплекты за по-интригуваща игра!  
Arvieno komplektus, lai pilnveidotu savas rotalas!  
Kombineeri komplekte, et mängu laiendada!  
Derinkite rinkinius ir išplėskite žaidimą!





76991



76992



76993



76994





Rebuild  
the  
world™



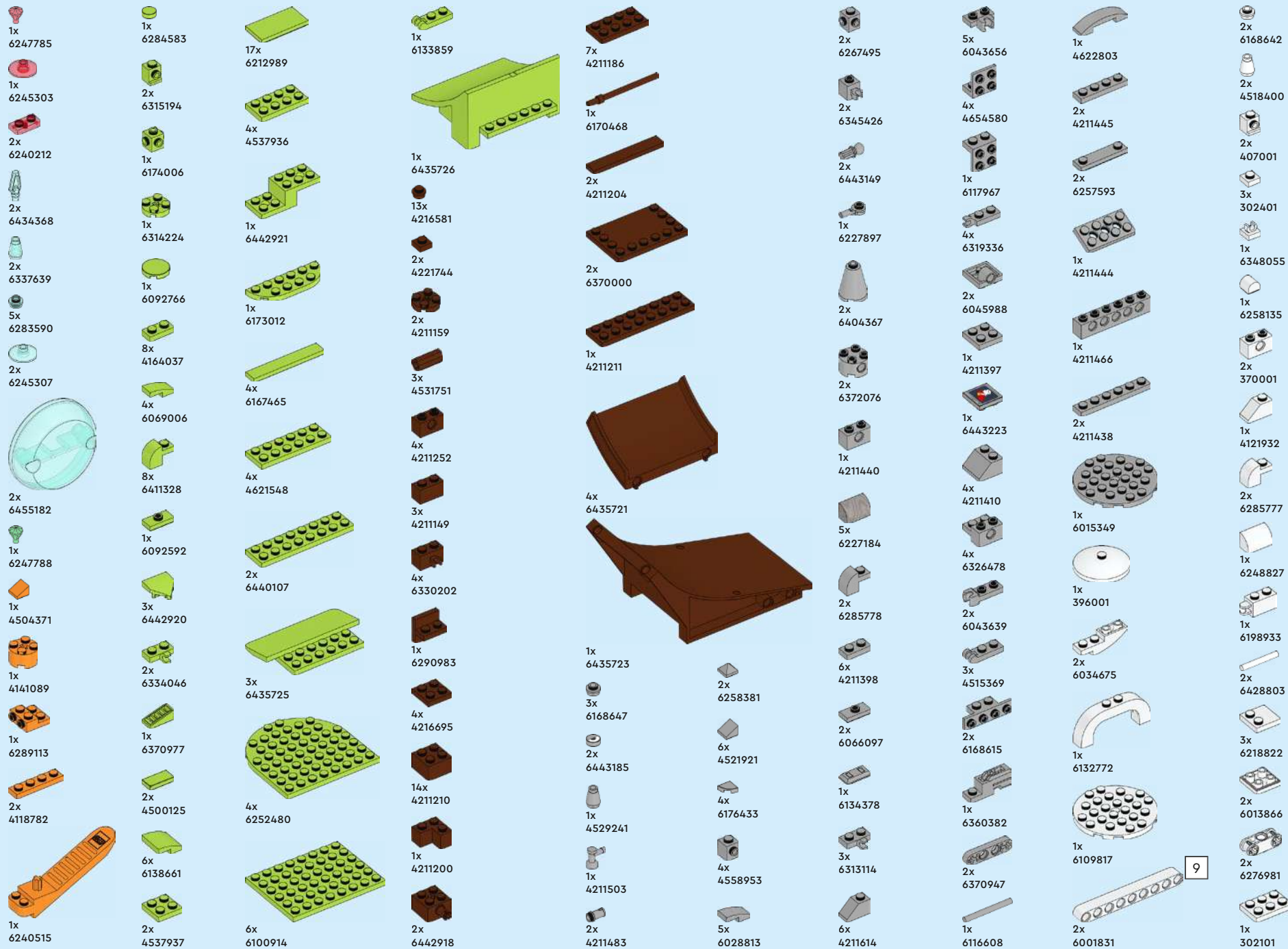

- 1x 4566028
- 6x 6413106
- 1x 6360675
- 2x 6296892
- 2x 6350724
- 4x 6318697
- 3x 6005331
- 1x 6135014
- 5x 4211063
- 2x 6230233
- 2x 6039479
- 1x 6314192
- 5x 6250018
- 1x 4261908
- 4x 6146321
- 122
- 1x 6397633
- 2x 6296856
- 1x 6395635
- 6x 4210719
- 2x 6262899
- 2x 6123814
- 1x 4211055
- 4x 6015356
- 1x 6039482
- 3x 6083620
- 4x 4211001
- 1x 6452585
- 1x 6378120
- 2x 307021
- 1x 6144805
- 2x 4651524
- 3x 403221
- 8x 4142865
- 1x 6173922
- 2x 6381444
- 1x 6453339
- 1x 366521
- 1x 4121934
- 3x 6313120
- 2x 6146217
- 2x 6347308
- 2x 6173961
- 1x 4540382
- 1x 6394880
- 2x 6092565
- 2x 243221
- 1x 6173126
- 1x 6453338
- 1x 4226876
- 1x 306821
- 1x 6453242
- 1x 6443218
- 1x 6443211
- 2x 6023770
- 2x 302121
- 1x 6443200
- 11
- 2x 4562805
- 8x 4206482
- 1x 6372164
- 2x 6299413
- 1x 6452519
- 4x 6441687
- 4x 6271167
- 1x 306224
- 3x 4550348
- 1x 403224
- 1x 6078279
- 1x 6294771
- 3x 6331822
- 3x 6441692
- 2x 302324
- 2x 6069170
- 5x 6344181
- 6x 241224
- 2x 6337231
- 2x 6449912
- 2x 6261356
- 1x 303924
- 4x 6275508
- 2x 6228602
- 2x 4247771
- 1x 6116606
- 1x 6248804
- 4x 6308390
- 1x 6397506
- 1x 6443197
- 1x 6132767
- 1x 6265148
- 1x 6168646
- 2x 6284699
- 1x 6443224
- 1x 4106347
- 1x 302426
- 2x 6335388
- 2x 6187572
- 4x 6234695
- 2x 6336977
- 2x 4516843
- 4x 6344752
- 44x 6279875
- 2x 6252373
- 2x 6195325
- 1x 4644456
- 1x 6265091
- 1x 6331716
- 1x 6443216
- 4x 4198367
- 5x 6347310
- 1x 6275732
- 1x 6147050
- 1x 6047276
- 2x 241226
- 1x 6315887
- 1x 6448318
- 9x 6020193
- 1x 4225201
- 2x 6211476
- 3x 302226
- 3x 6207258
- 2x 370126
- 1x 4558957
- 4x 6325190
- 2x 6280168
- 4x 303726
- 1x 370626
- 6
- 1x 303626

- 2x 6400649
- 1x 6413060
- 1x 6287854
- 4x 6322820
- 1x 6322904
- 3x 6244730
- 2x 6258607
- 4x 6138624
- 1x 4666579
- 1x 6443214
- 4x 6443371
- 2x 6102756
- 1x 6452559
- 2x 6380676
- 1x 6372047
- 1x 6057986
- 1x 6443154
- 1x 6419636
- 1x 6443212
- 1x 4119479
- 1x 6372047
- 1x 6057986
- 1x 6136419
- 1x 6419636
- 2x 6347604
- 3x 6400112
- 1x 4114077
- 4x 6192920
- 2x 6060857
- 1x 6289758
- 14x 6389695
- 1x 4114077
- 4x 6192920
- 2x 6060857
- 1x 6289758
- 2x 6347604
- 4x 6252667
- 2x 6195267
- 2x 4114084
- 19x 6058085
- 1x 6097042
- 1x 6312357
- 3x 6382575
- 4x 4113233
- 1x 6313600
- 1x 6138571
- 2x 6261546
- 1x 6312357
- 1x 4113233
- 1x 6313600
- 1x 6138571
- 2x 6261546
- 1x 6312357
- 1x 4546705
- 1x 6443217
- 4x 6435722
- 1x 6253666
- 1x 6070302
- 2x 6210271
- 1x 6443217
- 4x 6435722
- 1x 6253666
- 2x 6070302
- 6x 6253140
- 1x 6443217
- 4x 6435722
- 1x 6253666
- 2x 6070302
- 2x 6226931
- 3x 6109329
- 1x 6435724
- 1x 6296050
- 2x 6174946
- 1x 6447756
- 2x 6146227
- 1x 6361354
- 1x 6435724
- 1x 6296050
- 3x 6097036
- 2x 6174946
- 1x 6447756
- 2x 6458485



YOU COULD **WIN** 

Scan this QR code or go to **LEGO.COM/PRODUCTFEEDBACK** and give us your short feedback about this LEGO® set for a chance to win a cool LEGO prize.

Terms and Conditions apply\*



**EN: YOU COULD WIN.** Terms and Conditions apply\* **DE: Du könntest GEWINNEN.** Es gelten die Teilnahmebedingungen\* **FR: Tu pourrais GAGNER.** Des conditions s'appliquent\* **IT: Potresti VINCERE tu.** Termini e condizioni sono applicabili\* **ES: Puedes GANAR.** Aplican términos y condiciones\* **PT: Poderá GANHAR.** Aplicam-se termos e condições\* **ZH: 轻松获奖. 条款和条件适用\*** **PL: Szansa na WYGRANĄ.** Obowiązują warunki korzystania\* **CS: Máte šanci VYHRÁT.** Platí všeobecné smluvní podmínky\* **SK: Máte šancu VYHRAŤ.** Platia všeobecné zmluvné podmienky\* **HU: TE IS NYERHETSZ.** Felhasználási feltételek érvényesek\* **RO: Ai putea CÂȘTIGA.** Se aplică termeni și condiții\* **BG: Можете да СПЕЧЕЛИТЕ.** Има определени правила и условия\* **LV: Tu vari LAIMĒT.** Ir spēkā noteikumi un nosacījumi.\* **ET: Sul on võimalus VÕITA.** Kehtivad tingimused\* **LT: Jūs galite LAIMĖTI.** Taikomos sąlygos\*

\*[LEGO.com/productfeedback-terms](https://www.lego.com/productfeedback-terms)

LEGO and the LEGO logo are trademarks of the LEGO Group. ©2023 The LEGO Group.  
©SEGA. All rights reserved. SEGA is registered in the U.S. Patent and Trademark Office.  
SEGA and SONIC THE HEDGEHOG are either registered trademarks or trademarks of SEGA CORPORATION.