



NINJAGO

DRAGONS RISING

71808



LEGO® Builder



LEGO.com/sustainable-packaging



 **FR**
DONNEZ
OU
RECYCLEZ

 OU  OU 

ASSOCIATION MAGASIN DÉCHÈTERIE

Adresses sur quefairedemesdechets.fr

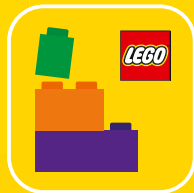

LEGO® Builder

BUILDER



Apple and the Apple logo are trademarks of Apple Inc., registered in the U.S. and other countries and regions. App Store is a service mark of Apple Inc. Google Play and the Google Play logo are trademarks of Google LLC. Tencent and the Tencent logo are trademarks of Tencent Inc.

LEGO.com/devicecheck

EN Ask parents' permission before going online | **DE** Eltern um Erlaubnis bitten, bevor du online gehst | **FR** Demande l'autorisation d'un parent avant d'aller en ligne | **IT** Chiedi il permesso ai tuoi genitori prima di andare online | **ES** Pídeles permiso a tus papás antes de conectarte a Internet | **PT** Peça autorização aos pais antes de acederes online | **ZH** 上网前应先征得父母的同意 | **PL** Poproś rodziców o zgodę, zanim wejdiesz do Internetu | **CS** Než půjdeš na internet, požádej rodiče o svolení | **SK** Skôr než pôjdeš na internet, vypýtaj si povolenie od rodičov | **HU** Kérj szülői engedélyt, mielőtt online csatlakoznál! | **RO** Cere permisiunea părinților înainte de a te conecta online | **BG** Поискайте разрешение от родител, преди да влезете онлайн | **LV** Pirms došanās tiešsaistē palūdz atļauju vecākiem | **ET** Enne Interneti kasutamist küsi vanematelt luba | **LT** Prieš prisijungdami prie interneto, atsiklauskite tėvų







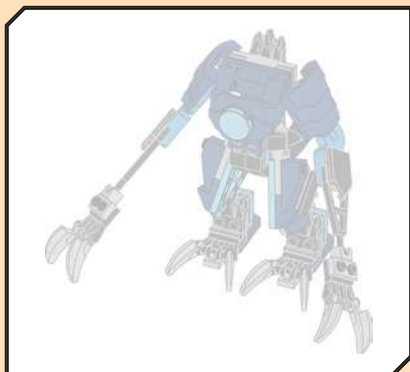

1

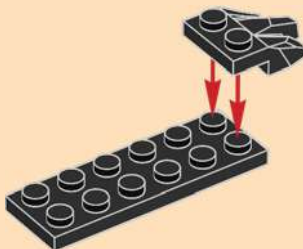



1x



2x

2

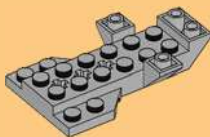

1x

3

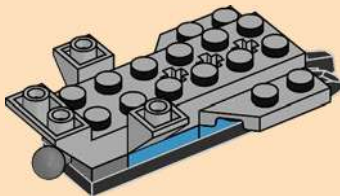



2x

4

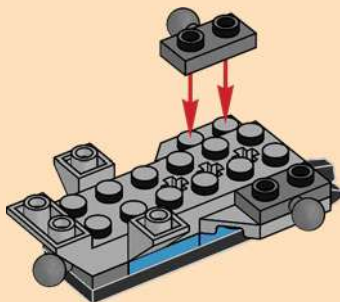

2x

5

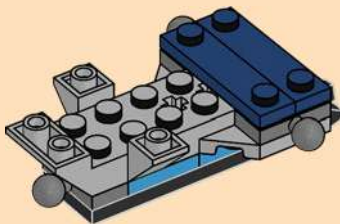



6

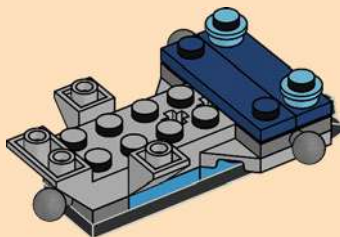

7

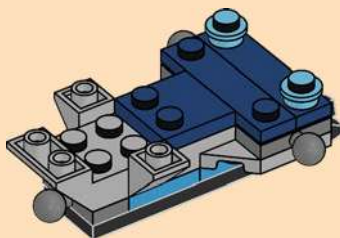



8

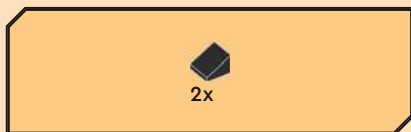
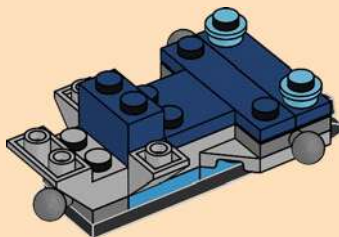

9

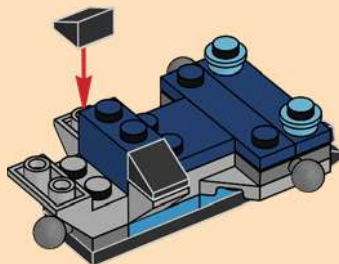



10

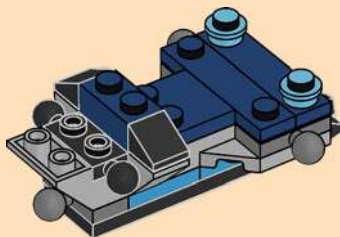

11

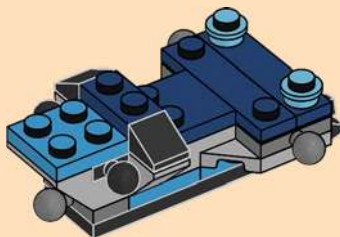



12

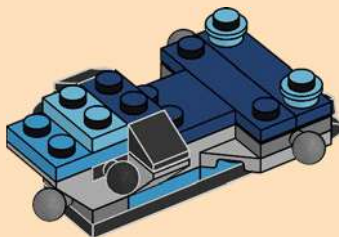

13

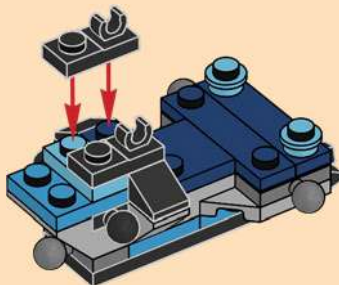



2x

14

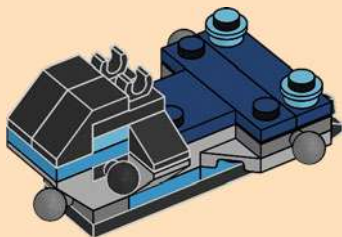

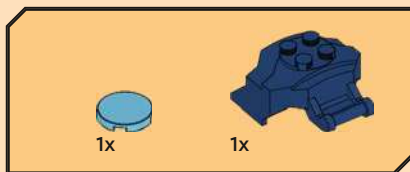

15

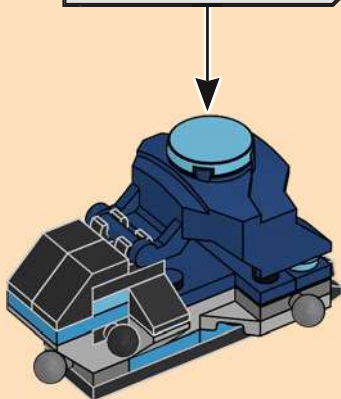
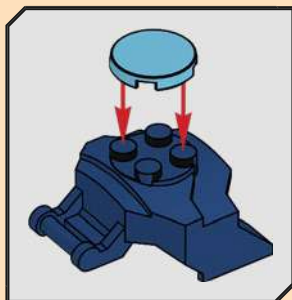

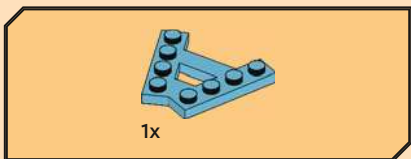

16

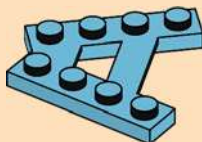

17

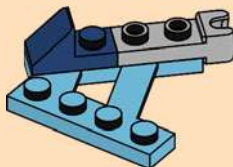



18

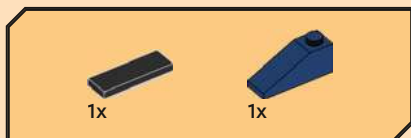
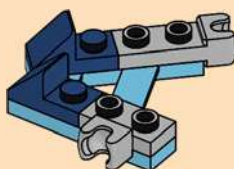

19

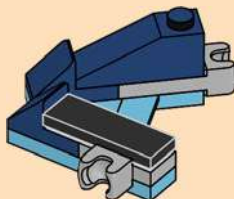

20

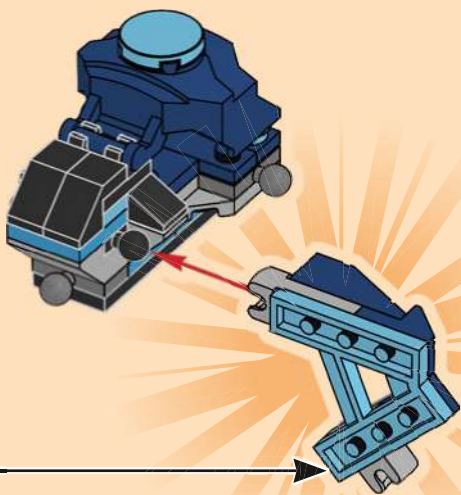

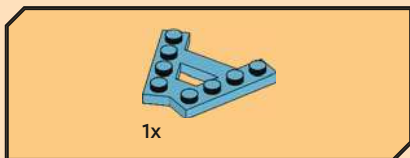

21

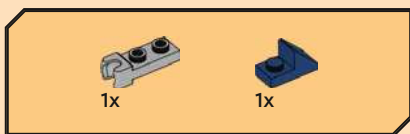
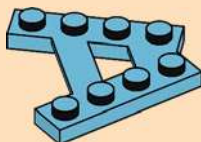

22

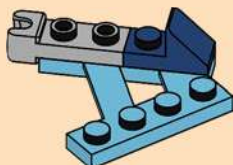



1x



1x

23

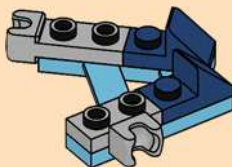

1x



1x

24

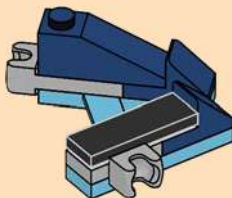

25

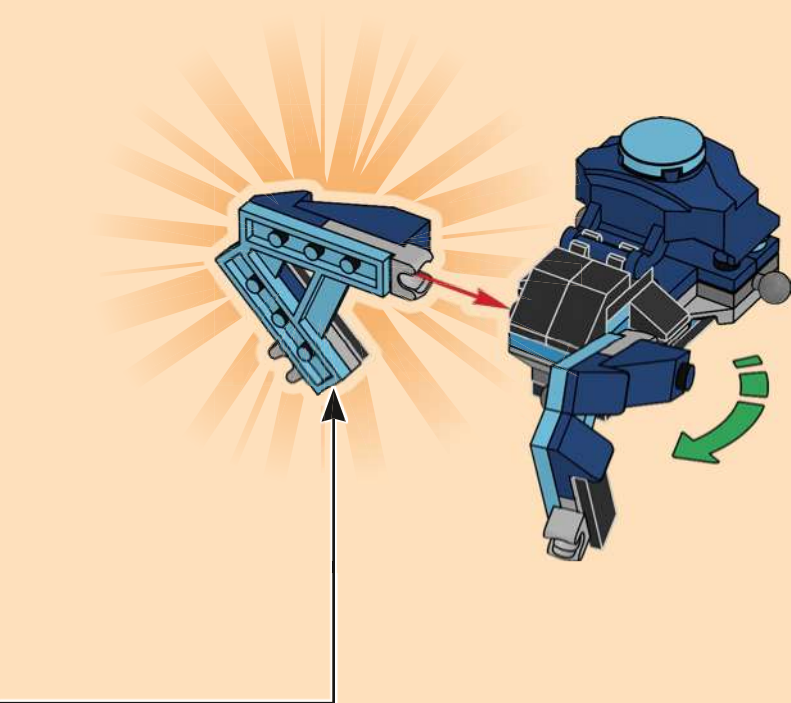



2x



1x

26





2x

27



1x

28



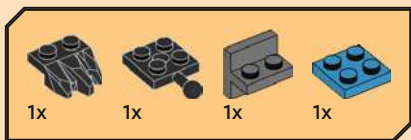

29

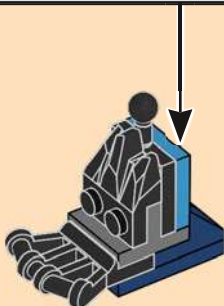
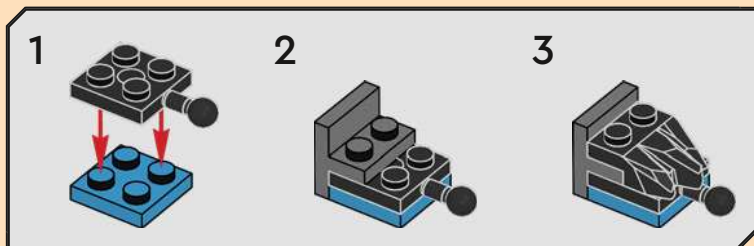



1x

30

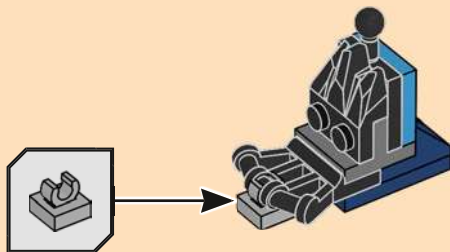

2x

31



2x

32

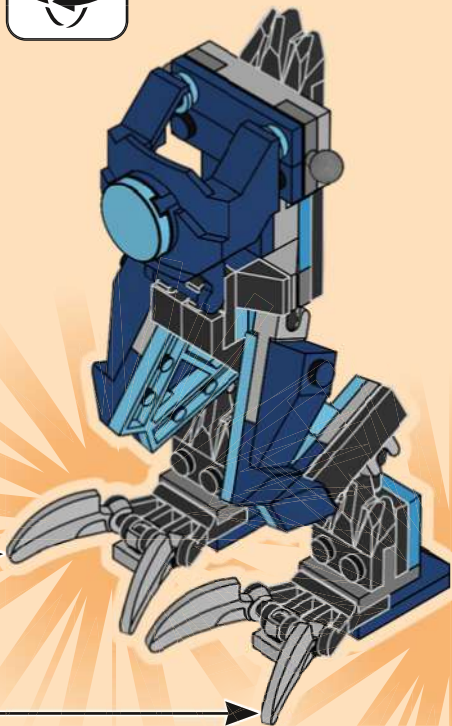

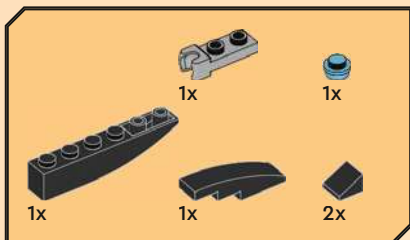
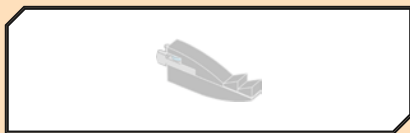

33

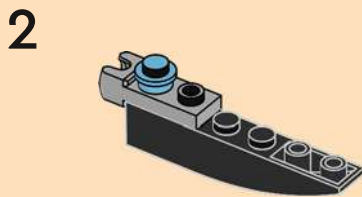
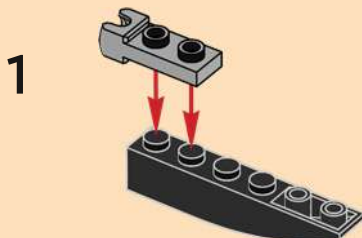

3

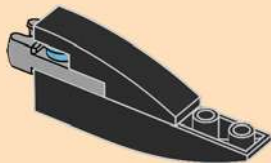

4

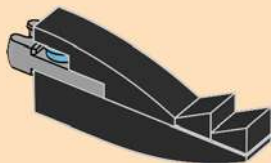

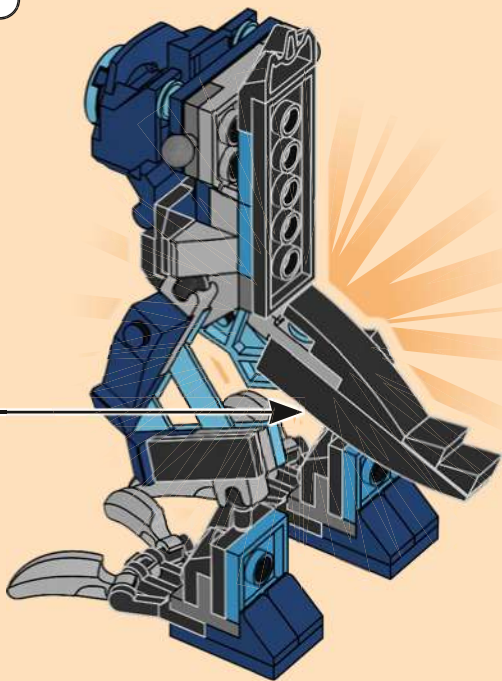

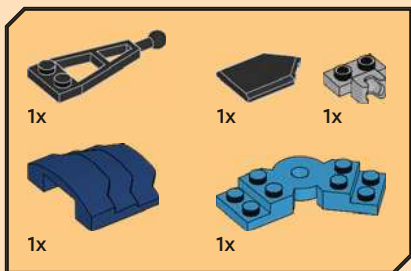

34

1

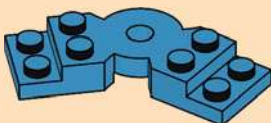

2



3



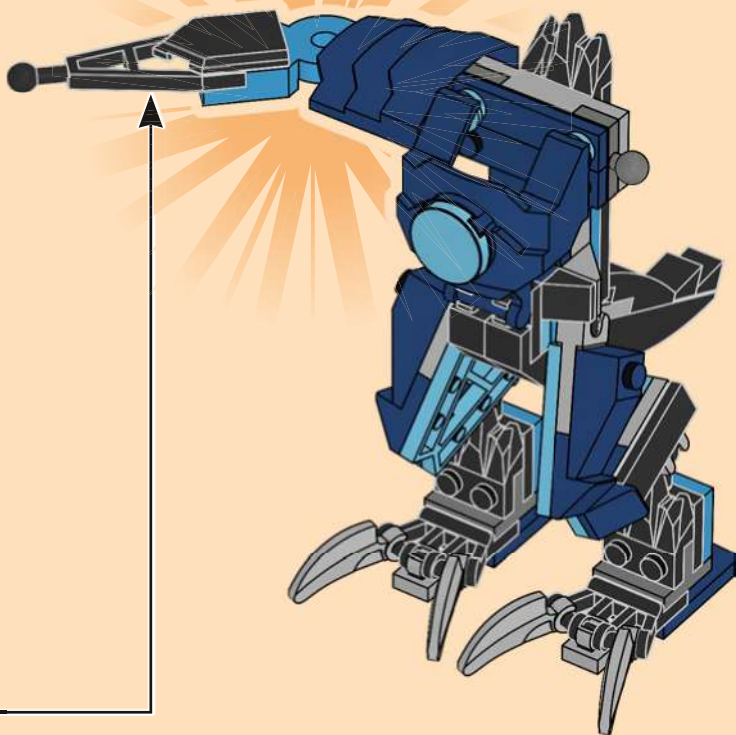

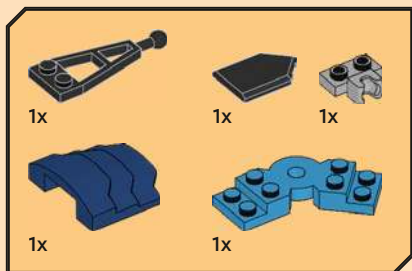

35

1



2



3



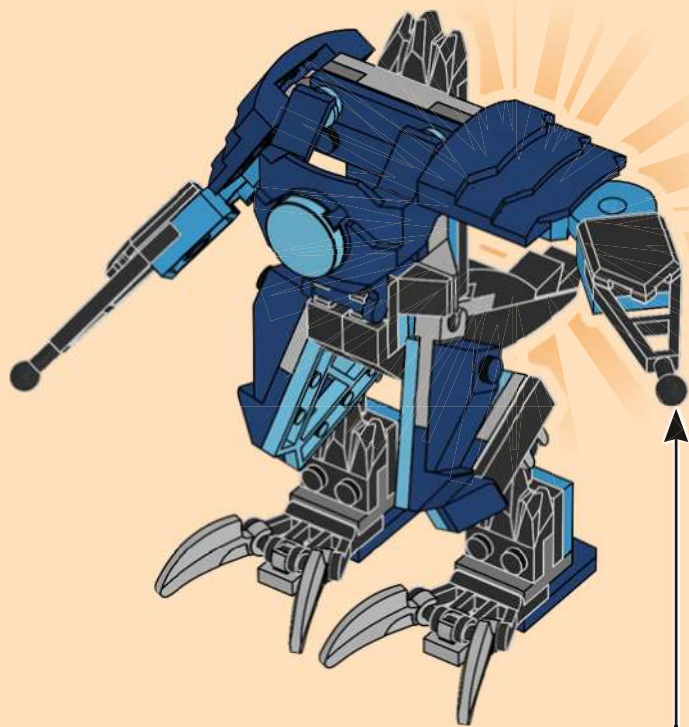



36

1

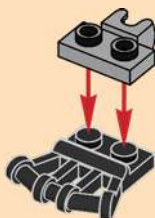

2

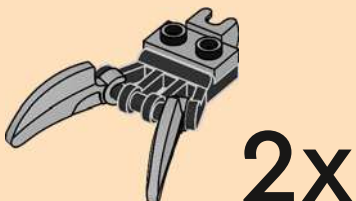

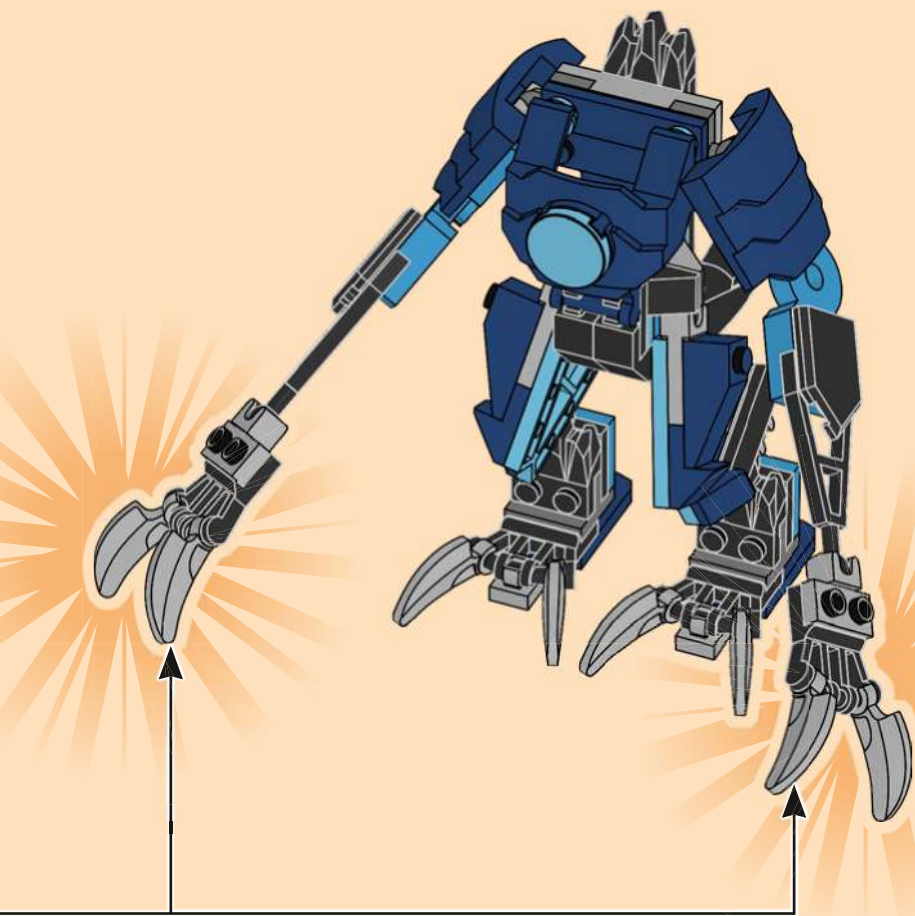

37

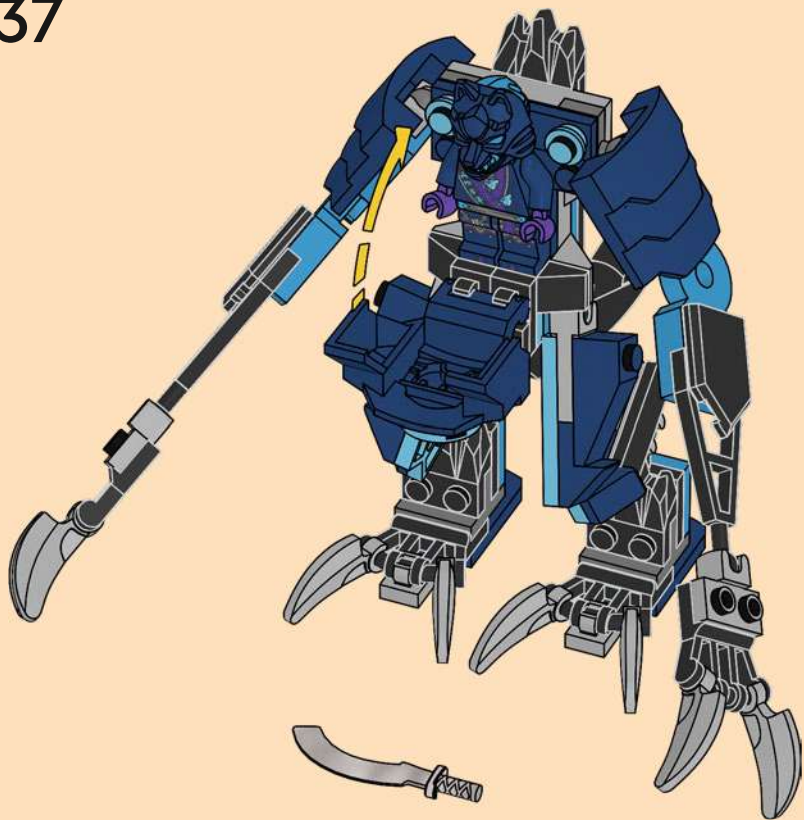







1x

1





2



3





4



5

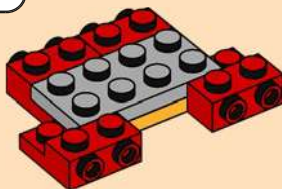



6

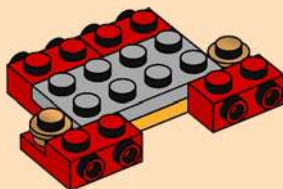

7

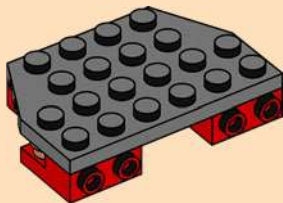

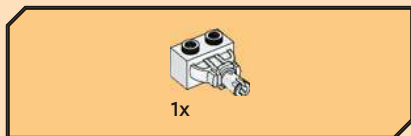

8

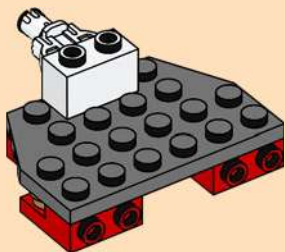

9

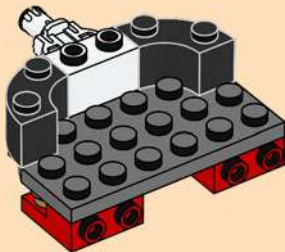

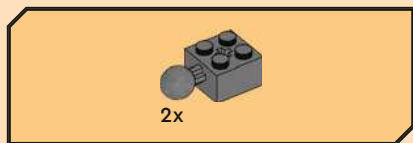

10

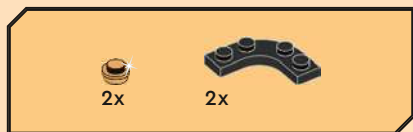
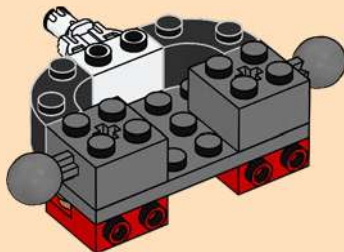

11

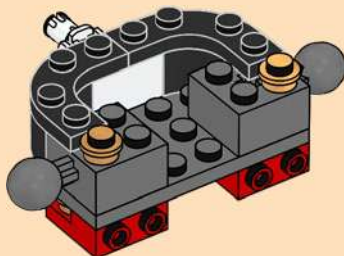



12

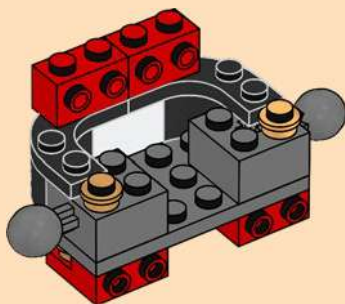

13

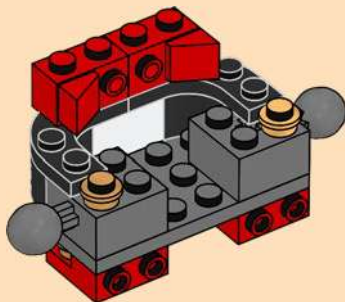



2x



2x

14

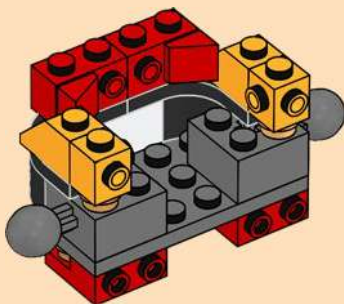

2x

15

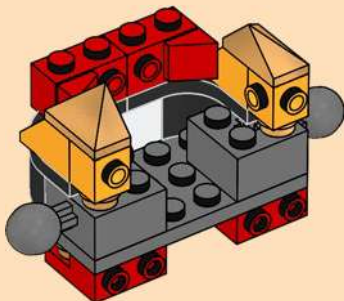



16

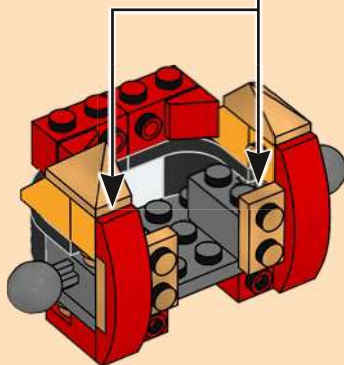
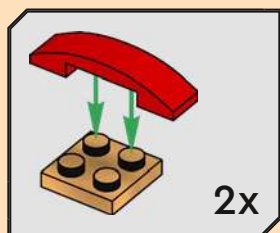

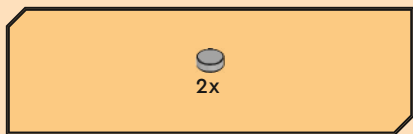

17

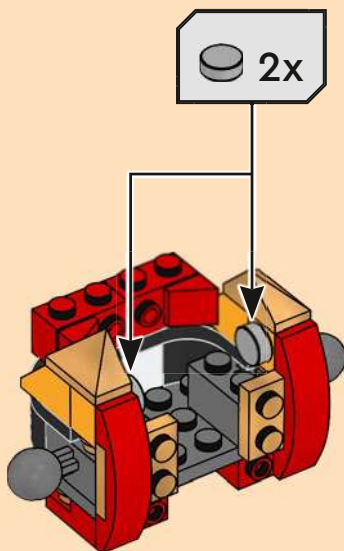



18

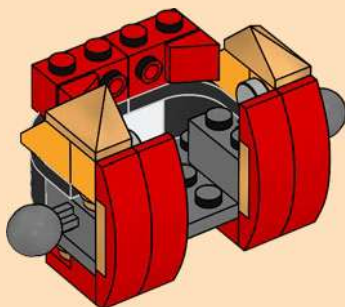

19

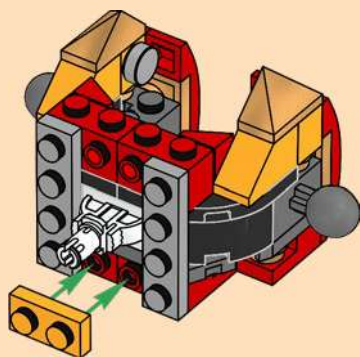



2x



2x

20

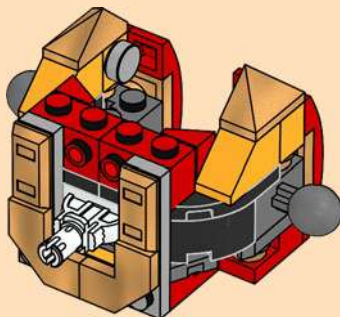

2x

21





22

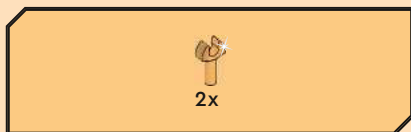
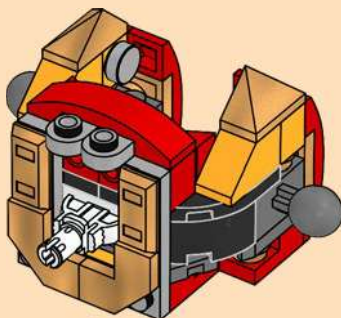

23

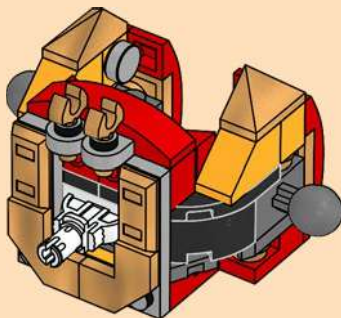



24

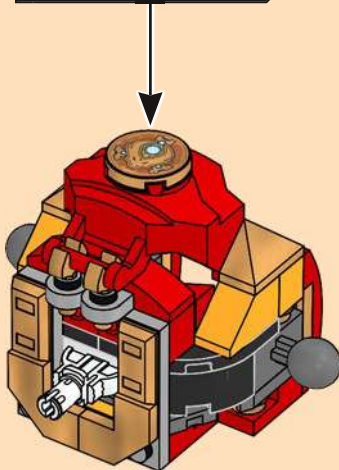
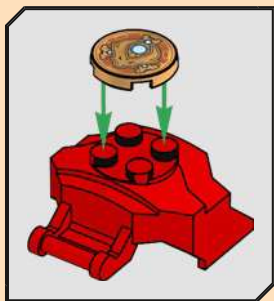

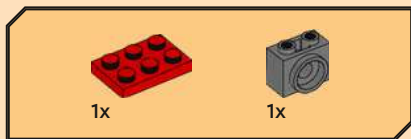

25

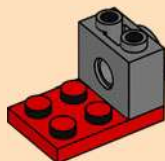

26



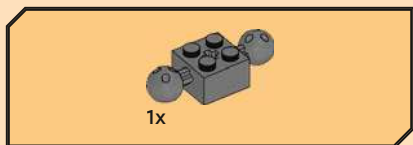

27



28





29



30

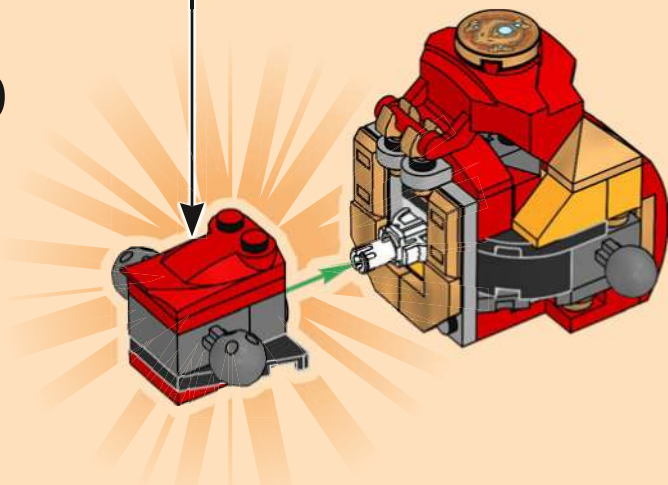

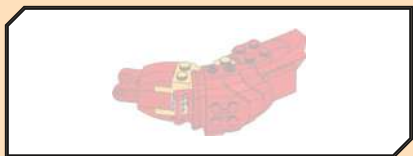

31

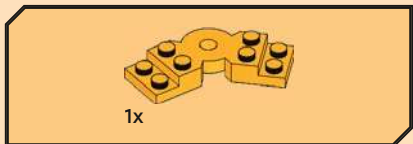
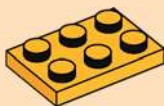

32





33



34

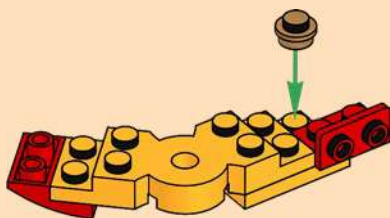



35

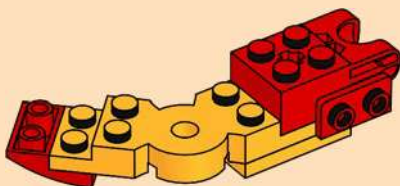

36

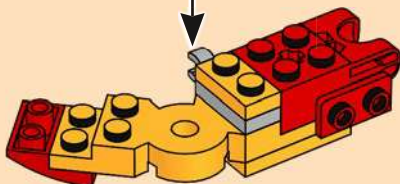
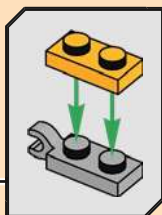



37

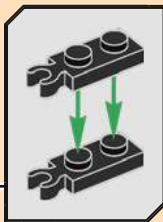
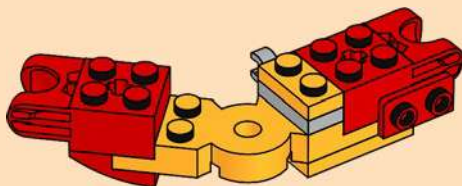

38

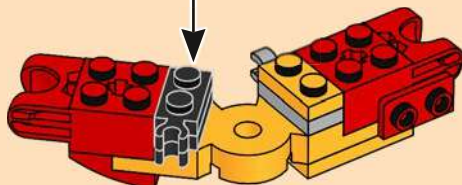

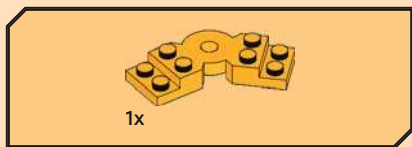

39



40

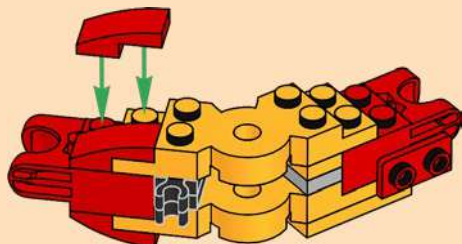



41

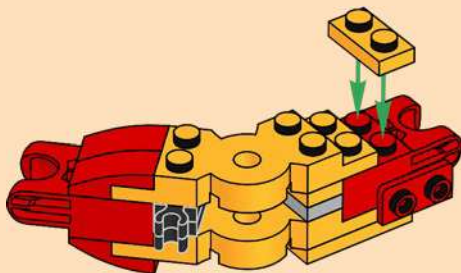

42

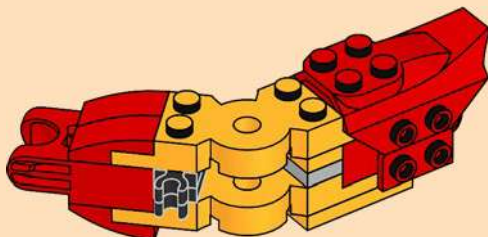



43

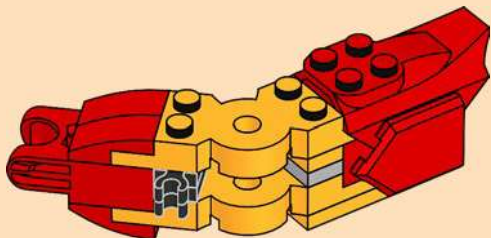

44



45

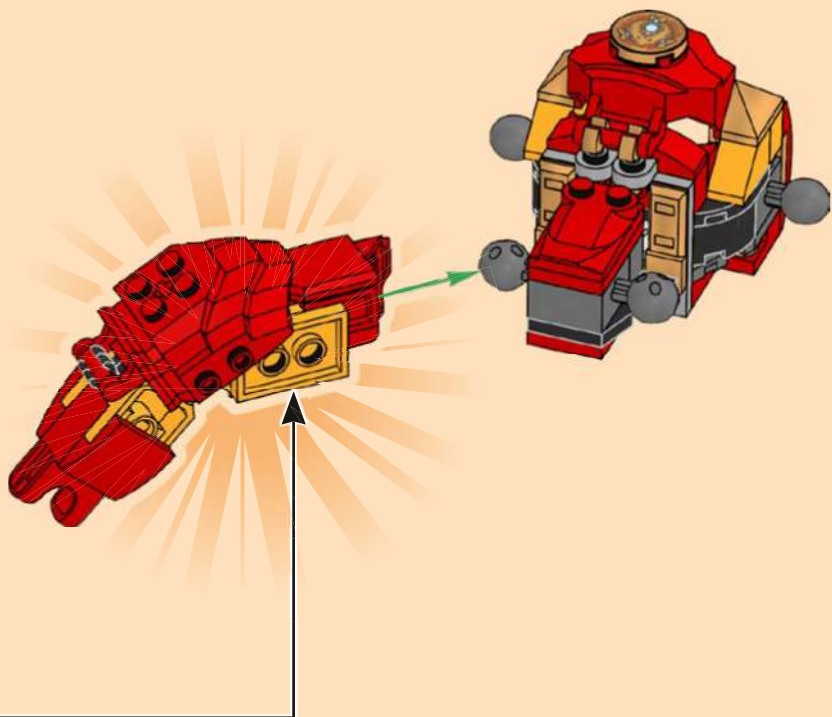

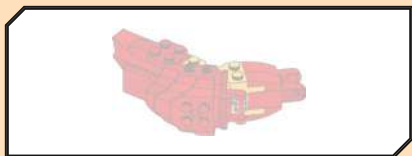

46

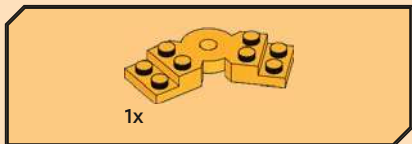
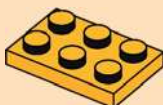

47





48

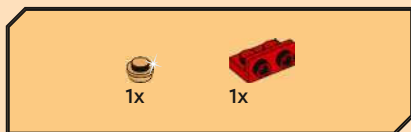
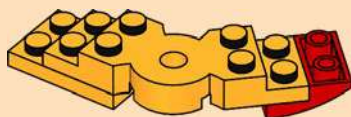

49

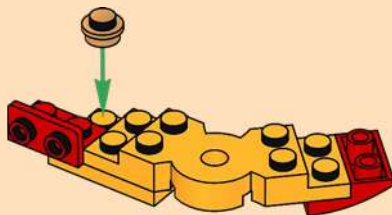



50

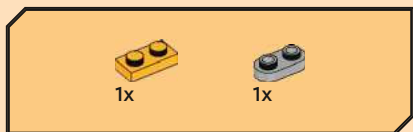
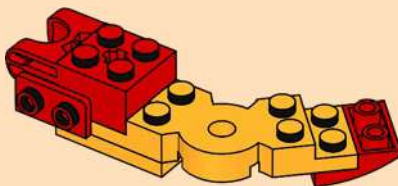

51

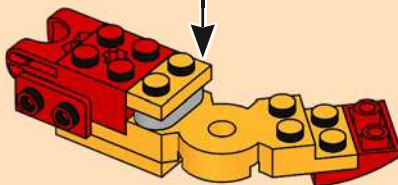
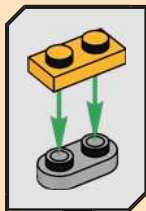



52



53

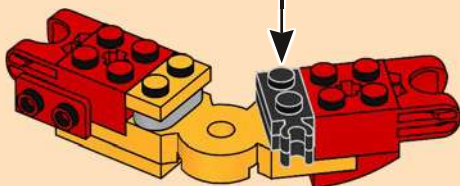
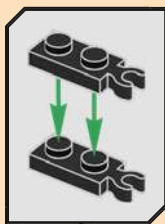

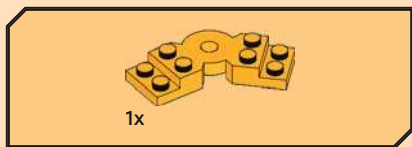

54



55

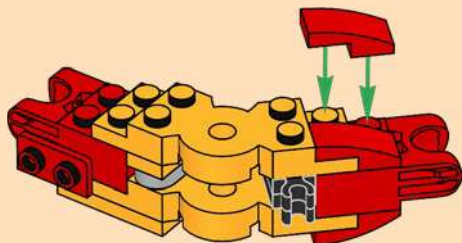



56

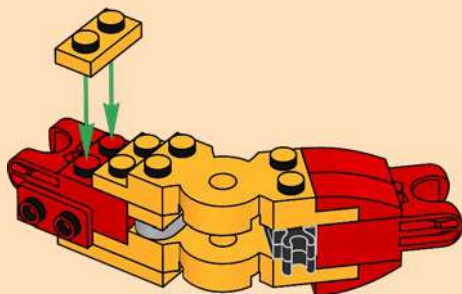

57

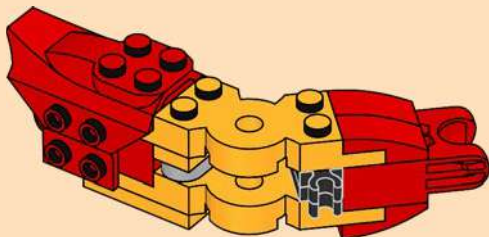



58

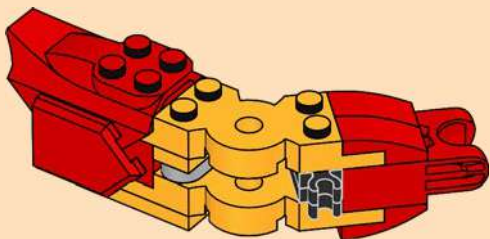

59



60

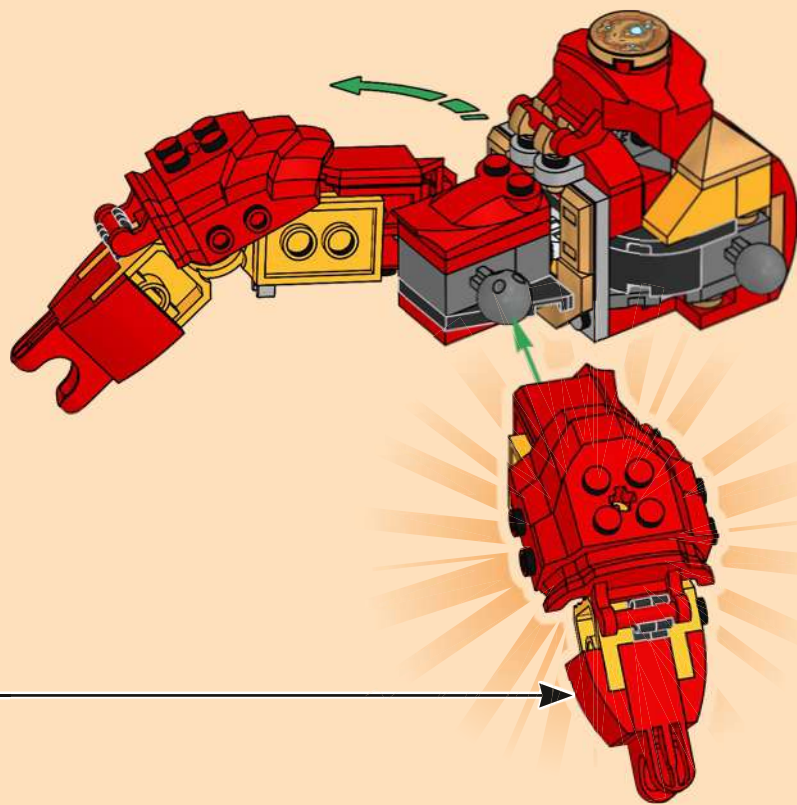



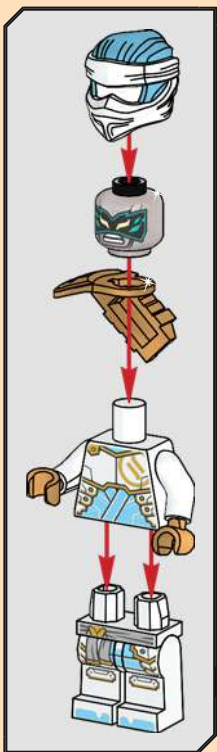



2x



1x

61



2x

62



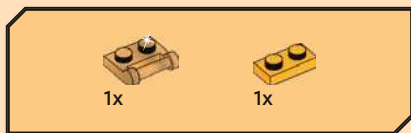

63

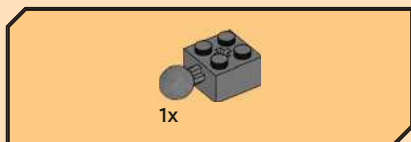

64





2x

65



2x

66





1x

67



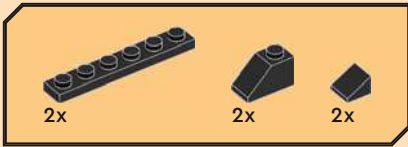

68

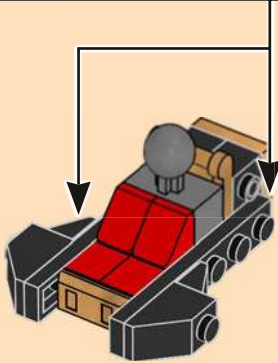
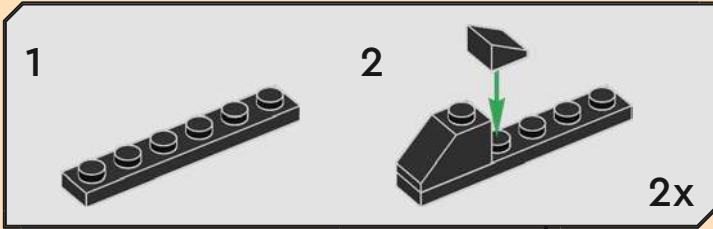



69

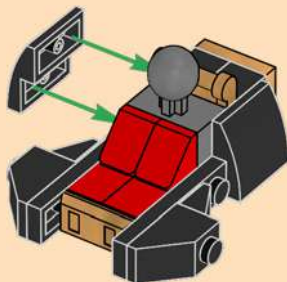

2x



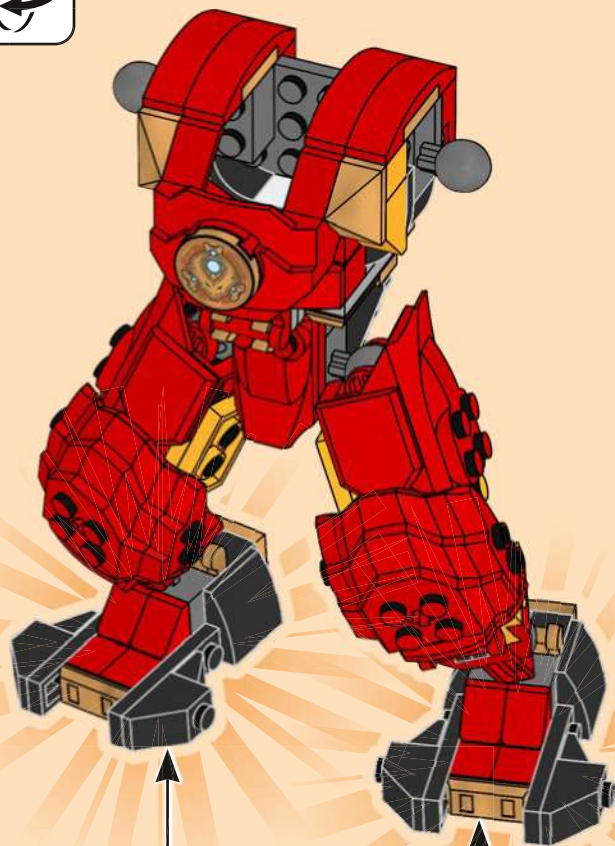

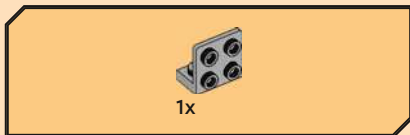

71



72





1x

73



2x

74



2x

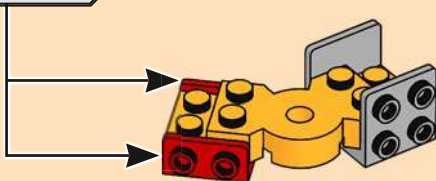



75

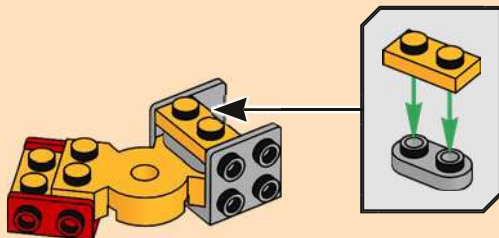

76

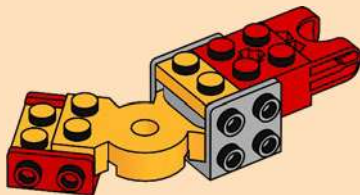



2x

77



2x

78

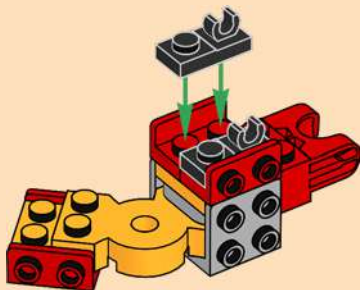



79



80

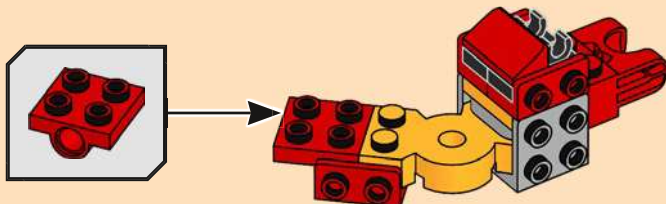



81

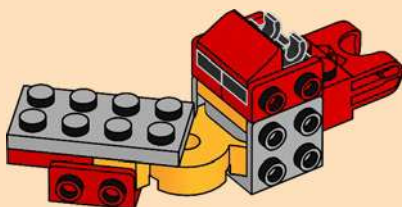

82





83



84

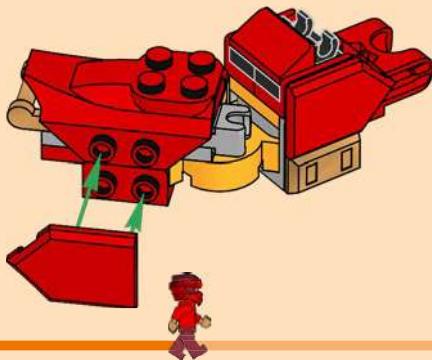

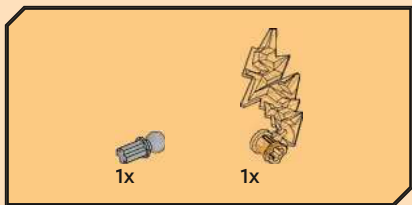

85

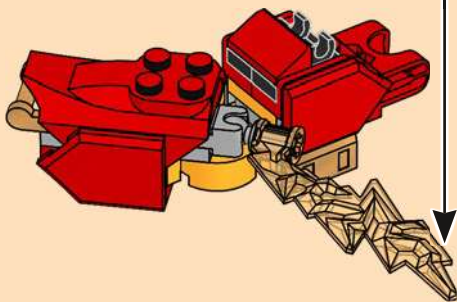
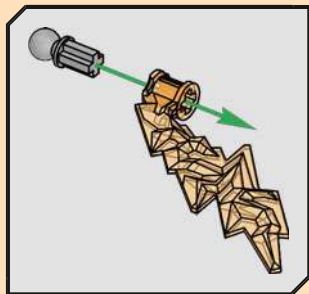



86

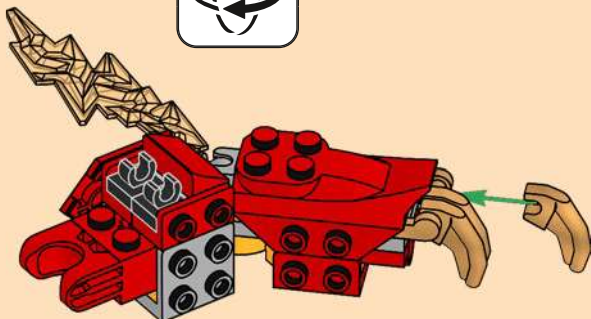

87

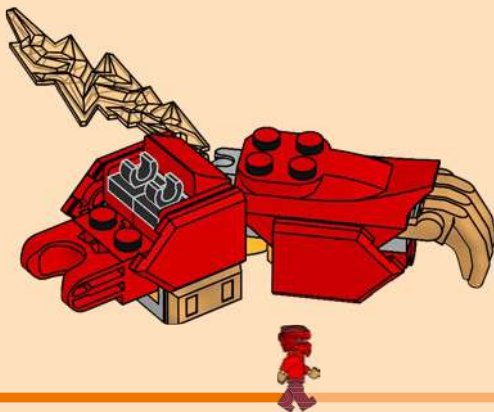

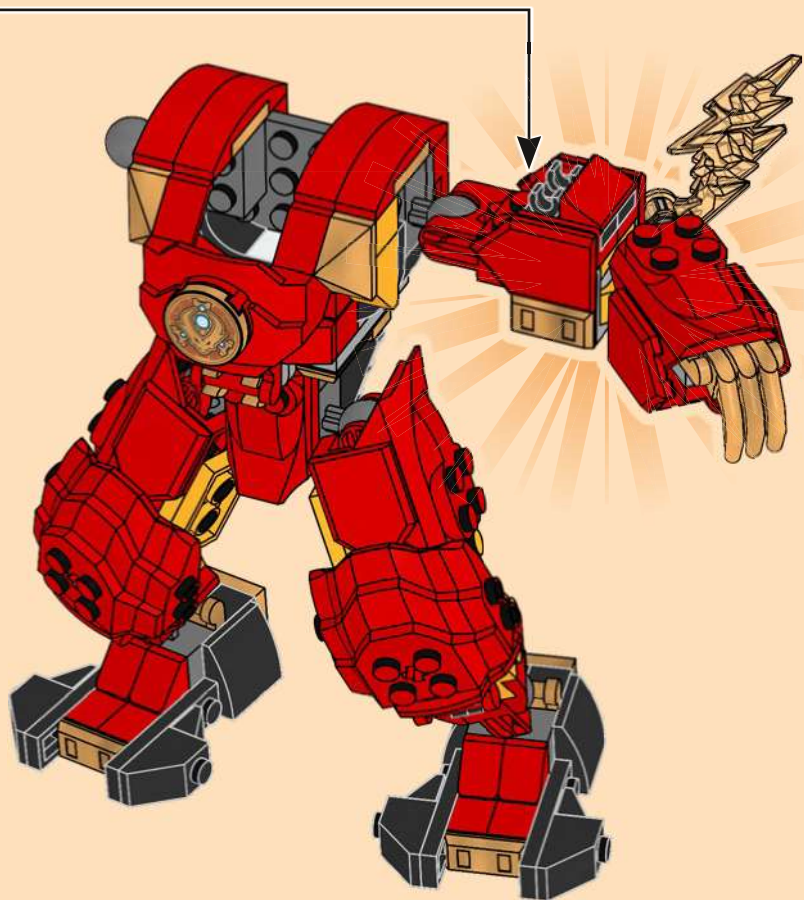

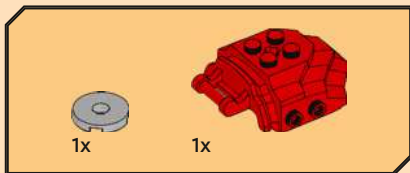

89



90

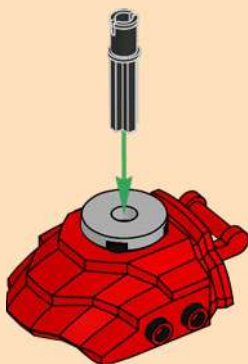



1x

91



1x

92

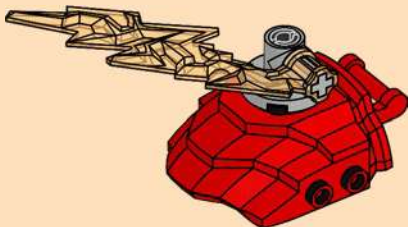

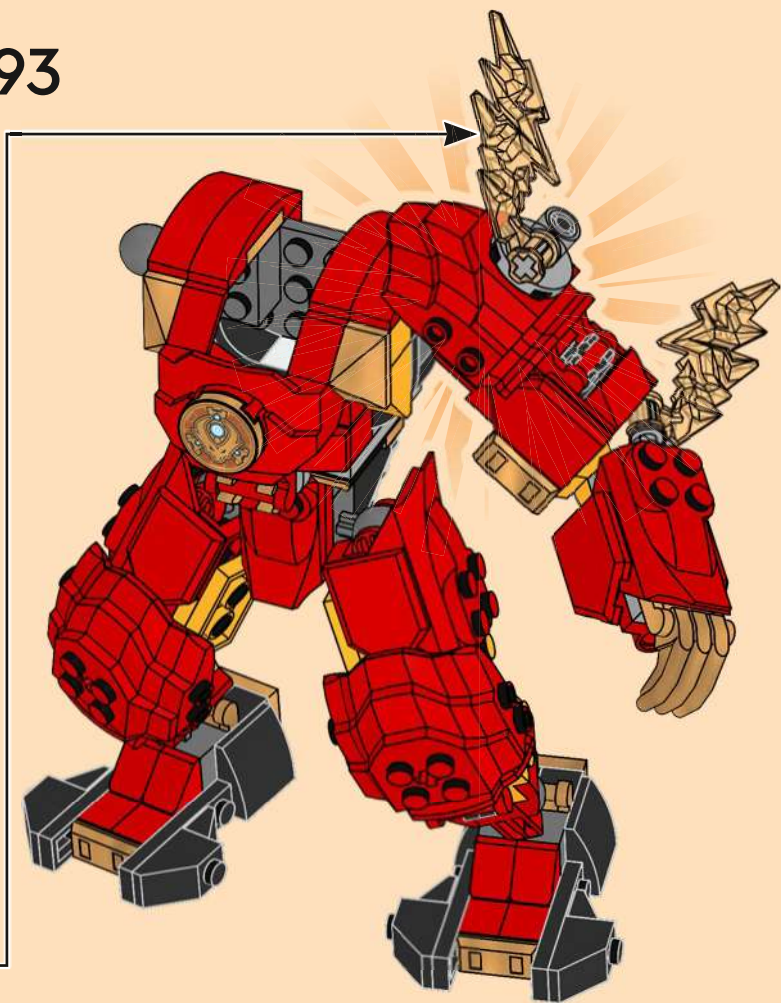



1x

94

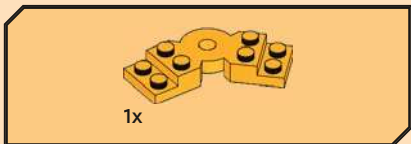

1x

95



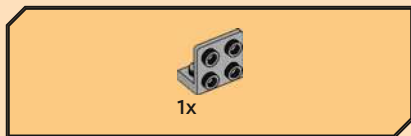

96



97



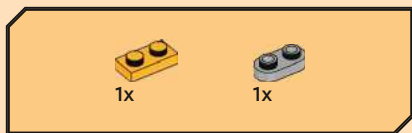

98

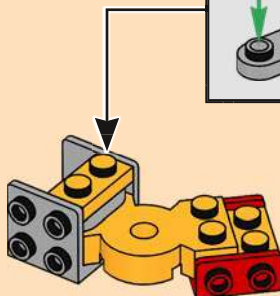
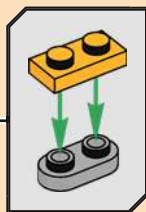

99

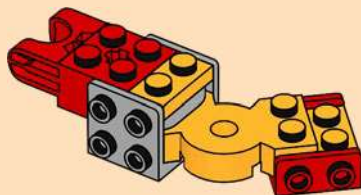



100

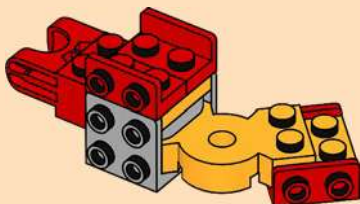

101

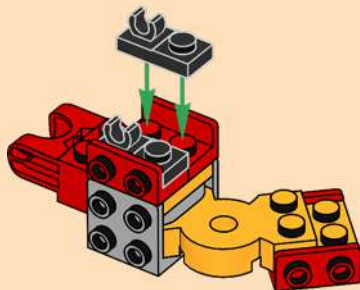



102



103





104

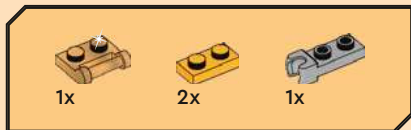

105





106



107



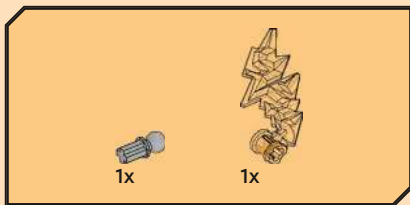

108

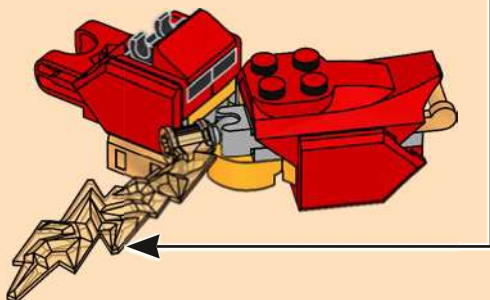
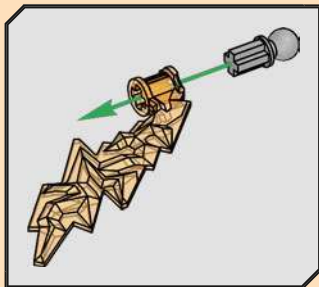



3x

109

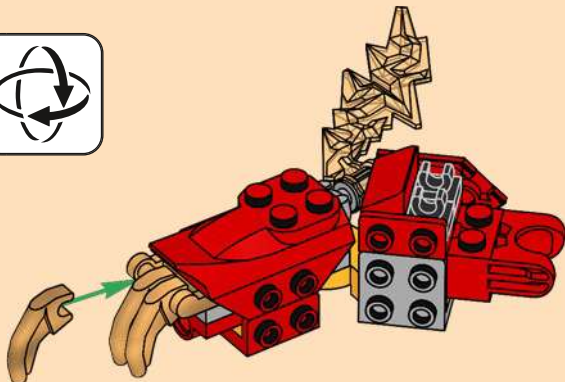

1x



2x

110

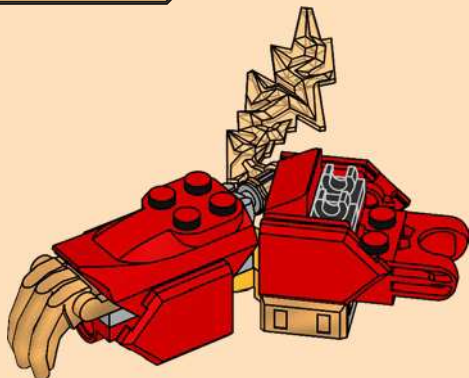

111

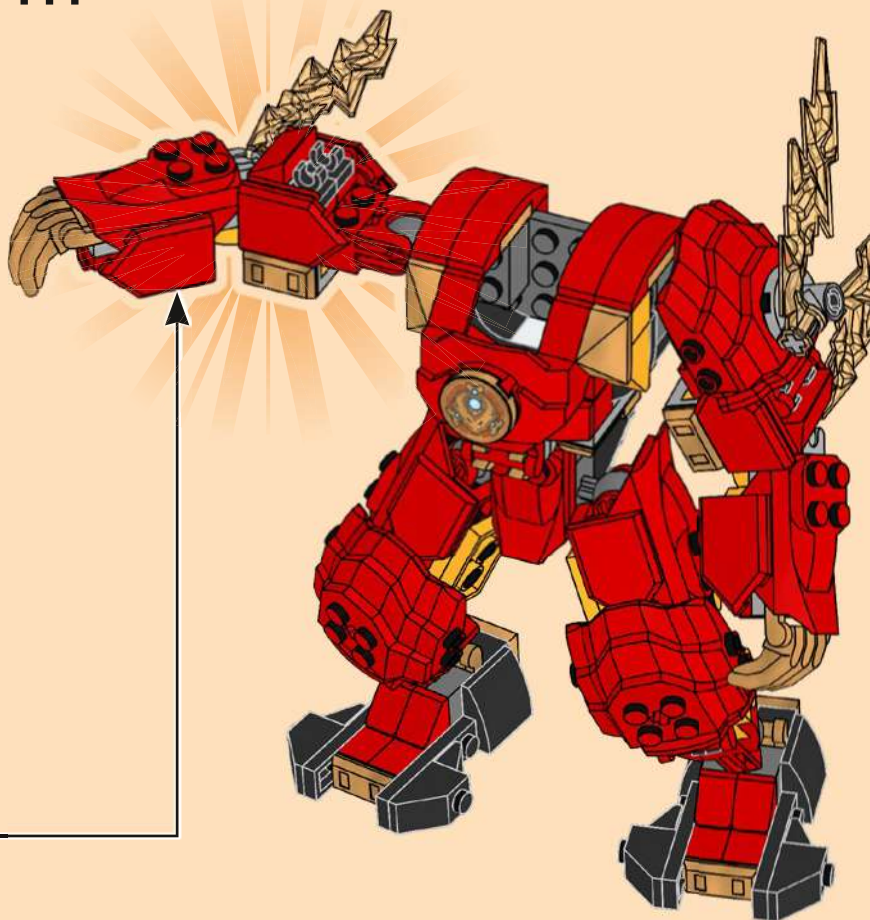

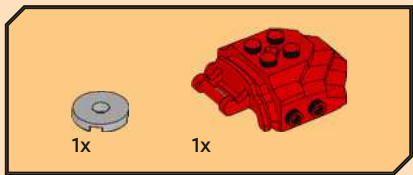

112

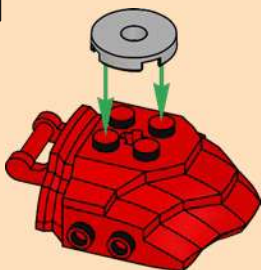

113

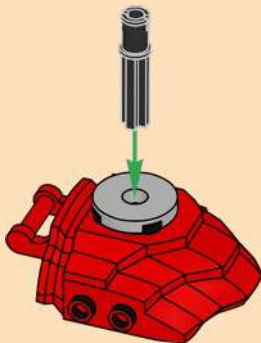



1x

114



1x

115



116

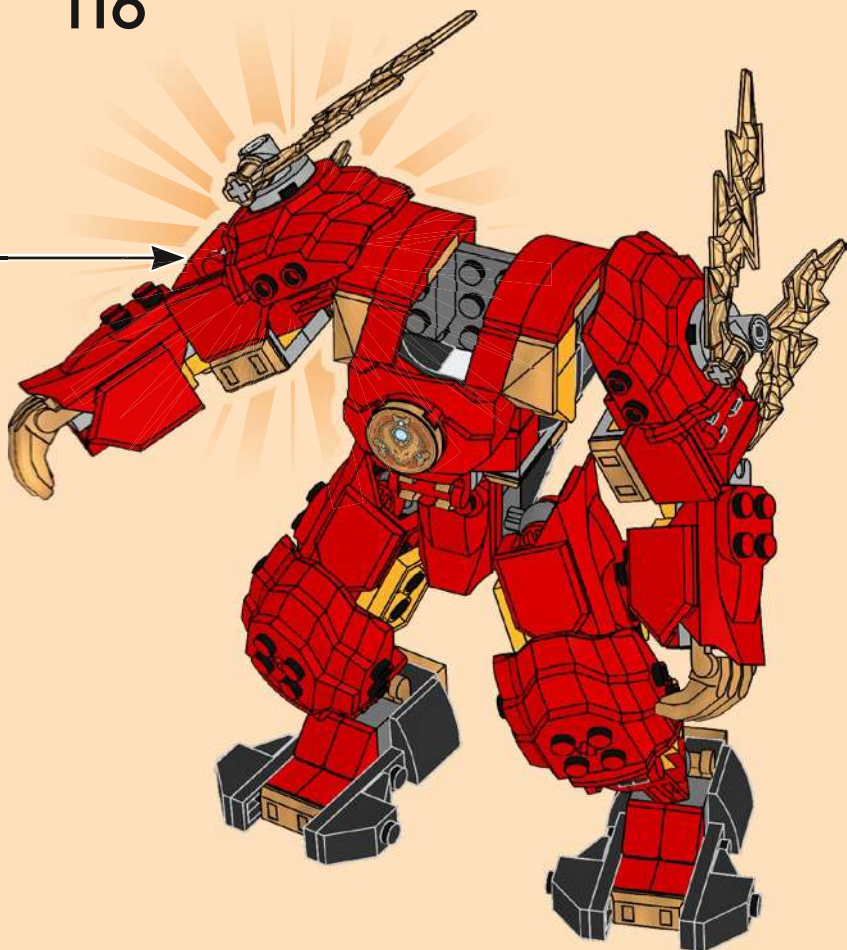

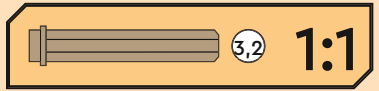
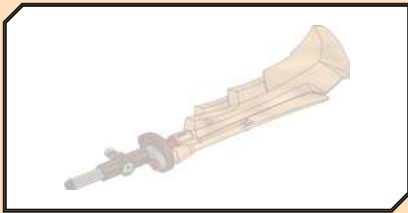

117

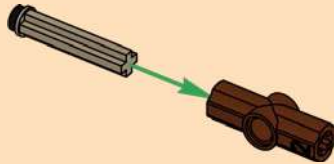

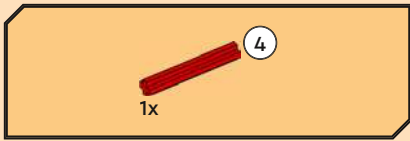

118

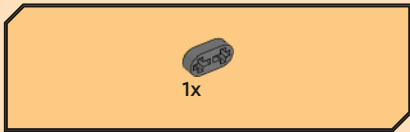

119





120



121

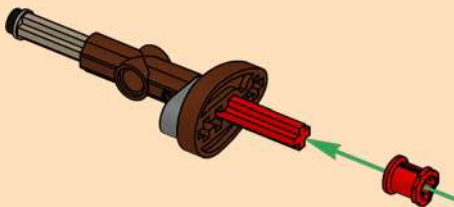



122

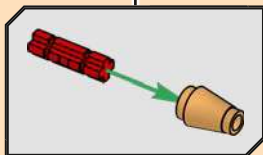

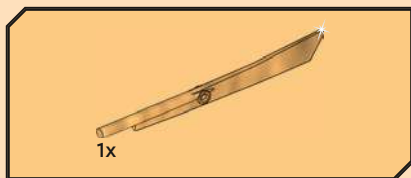

123

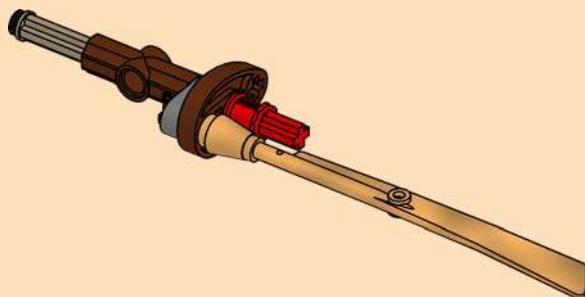

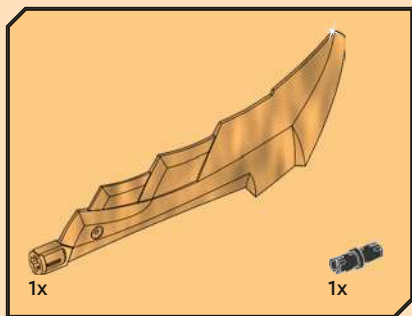

124

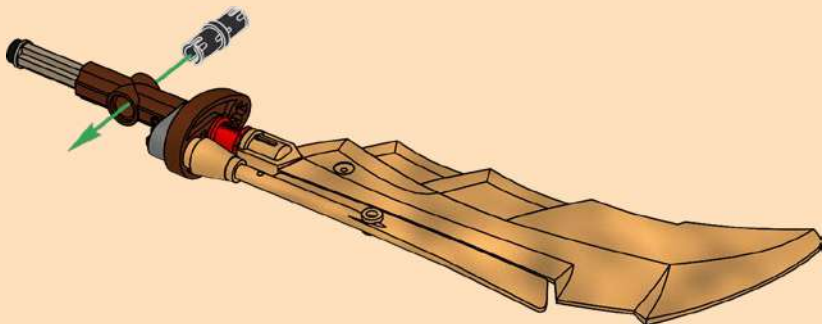

125

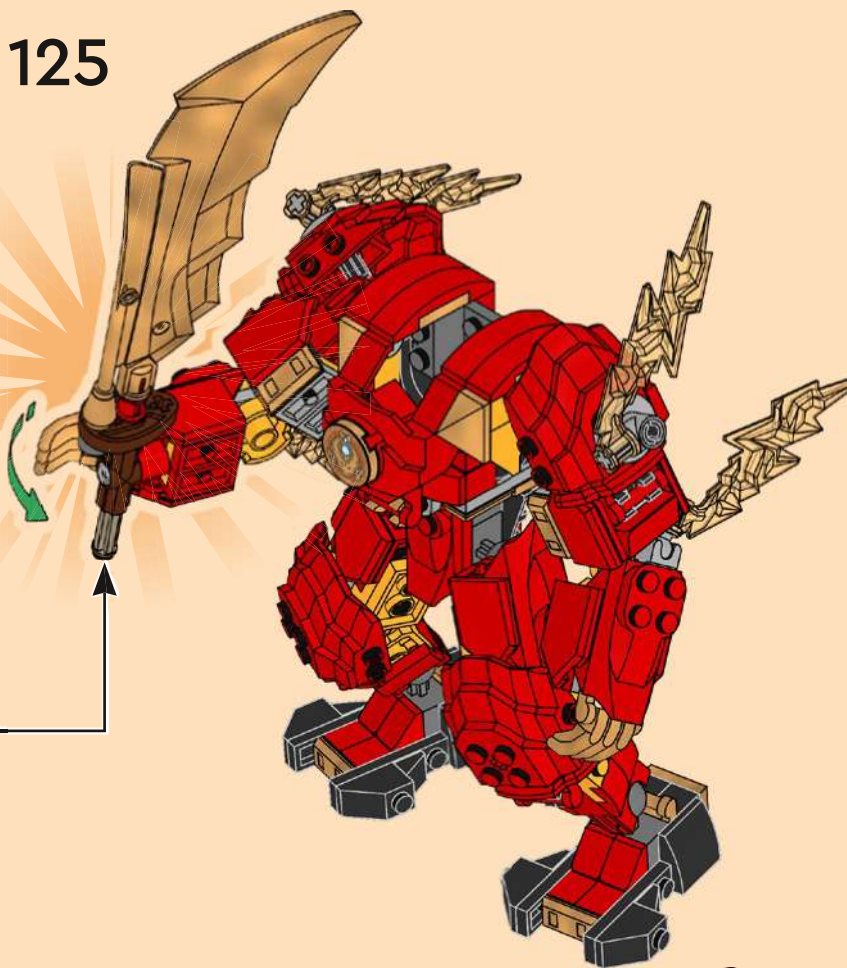

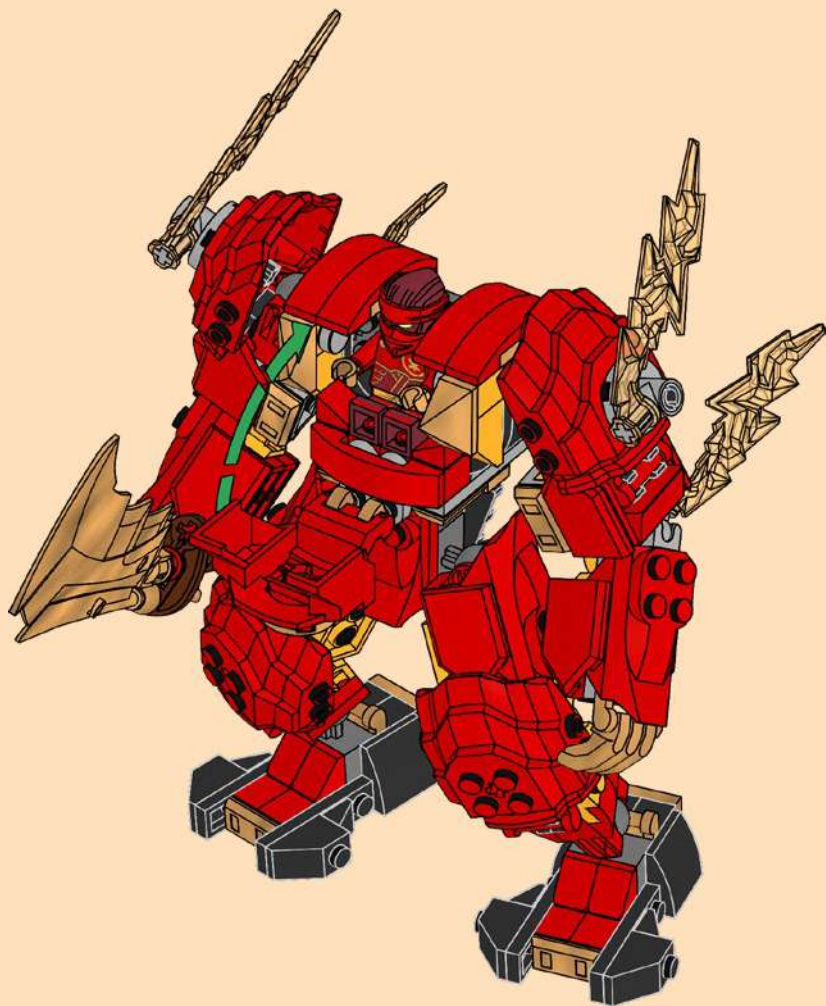

127

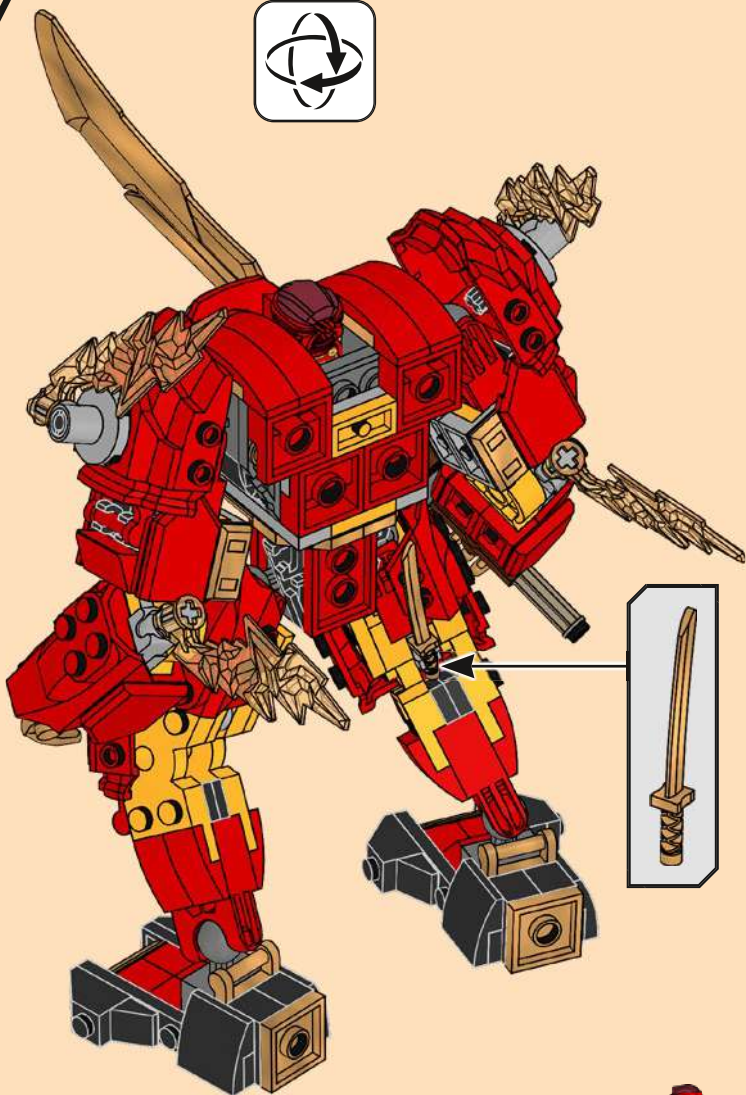





CUSTOMISE YOUR MECH

Customise Your Mech
Personalisier deinen Mech
Personalise ton robot
Personalizza il tuo mech
Personaliza tu meca
Personaliza o Teu Robô
定制你的机甲
Personalizuj swojego mecha

Uprav si svého robota
Uprav si svojho robota
Tedd egyediív robotodat!
Personalizează-ți robotul
Персоналізуйте свого робота
Pielāgo savu robotu
Kohanda oma robotit
Pritaikykite savo robotą

71806



A

71807



71808



B



C





1x
6464361



1x
6472887



1x
6469558



1x
6271820



2x
4504379



4x
6187620



2x
4651524



1x
4142865



2x
4569056



4x
6029946



4x
6053011



10x
6089698



2x
6014616



2x
6442314



4x
6469446



10x
6294045



1x
6469417



2x
302121



1x
6129995



1x
6143425



5x
4633914



6x
6406930



4x
6371695



1x
6371691



4x
6466698



1x
6434427



1x
6464357



8x
4504382



1x
6279875



6x
6347310



4x
4121966



4x
6138173



2x
6267487



3x
6195185



4x
6350725



4x
6053077



2x
4567436



2x
6089119



2x
6448318



2x
6245251



2x
4558170



1x
6416838



4x
4604304



1x
6037746



1x
6170529



1x
6332453



2x
6325190



2x
4274405



4x
366626



1x
6112323



1x
379526



1x
6468880



1x
6031821

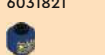

1x
6464352



1x
6468746

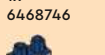

1x
6464359



1x
6464354



8x
6186683



1x
4249891



1x
6214810



2x
6103774



1x
6469005

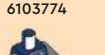

1x
6469272



1x
6472667



2x
4530028



2x
6256610



2x
6323472



1x
6461579



1x
6434440



1x
6270108



5x
6206809



2x
6365678



3x
6102986



1x
6469028



1x
6145255



2x
6124250

4

3,2



1x
6097419



1x
6464343



1x
6468881



1x
6473615



4x
6466697



2x
6292415



14x
6028736



2x
6023157



2x
6097503



6x
6466696



5x
6043639



2x
4211445



2x
6284071



2x
6308012



2x
6443149



5x
6248890



2x
6179186



2x
6123815



6x
6043656



4x
4654580



1x
6319336



8x
6359723



3x
4211395



1x
6452334



1x
6404660



1x
6333110



1x
6122727



1x
6338422



1x
6398662



3x
6039479



2x
6250018



4x
4497253



1x
6065816



1x
4521572



6x
6426622



2x
6075079



1x
6467216



1x
6294344



8x
6207933



2x
6116596



1x
6270131



1x
6417341



4x
4585493



4x
6347982



2x
6388241



2x
6453281



6x
4523159



1x
4529247



1x
6417341



 [LEGO.com/service](https://www.LEGO.com/service)

YOU COULD

WIN



Scan this QR code or go to
LEGO.COM/PRODUCTFEEDBACK
and give us your short feedback
about this LEGO® set for a chance
to win a cool LEGO prize.

Terms and Conditions apply*



EN: YOU COULD WIN. Terms and Conditions apply* **DE: Du könntest GEWINNEN.** Es gelten die Teilnahmebedingungen* **FR: Tu pourrais GAGNER.** Des conditions s'appliquent* **IT: Potresti VINCERE tu.** Termini e condizioni sono applicabili* **ES: Puedes GANAR.** Aplican términos y condiciones* **PT: Poderá GANHAR.** Aplicam-se termos e condições* **ZH: 轻松获奖. 条款和条件适用*** **PL: Szansa na WYGRANĄ.** Obowiązują warunki korzystania* **CS: Máte šanci VYHRÁT.** Platí všeobecné smluvní podmínky* **SK: Máte šancu VYHRAŤ.** Platia všeobecné zmluvné podmienky* **HU: TE IS NYERHETSZ.** Felhasználási feltételek érvényesek* **RO: Ai putea CÂȘTIGA.** Se aplică termenii și condiții* **BG: Можете да СПЕЧЕЛИТЕ.** Има определени правила и условия* **LV: Tu vari LAIMĒT.** Ir spēkā noteikumi un nosacījumi.* **ET: Sul on võimalus VÕITA.** Kehtivad tingimused* **LT: Jūs galite LAIMĖTI.** Taikomos sąlygos*

*[LEGO.com/productfeedback-terms](https://www.lego.com/productfeedback-terms)

LEGO, the LEGO logo and NINJAGO are trademarks of the LEGO Group. ©2024 The LEGO Group.

6497701