



# DREAMZZZ

71475



Q LEGO® Builder



[LEGO.com/sustainable-packaging](https://LEGO.com/sustainable-packaging)



**FR**  
**DONNEZ**  
OU  
**RECYCLEZ**

 OU  OU 

ASSOCIATION    MAGASIN    DÉCHÈTERIE

Adresses sur [quefairedemesdechets.fr](https://quefairedemesdechets.fr)

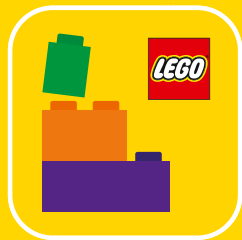

Q LEGO® Builder

# BUILDER



Apple and the Apple logo are trademarks of Apple Inc., registered in the U.S. and other countries and regions. App Store is a service mark of Apple Inc. Google Play and the Google Play logo are trademarks of Google LLC. Tencent and the Tencent logo are trademarks of Tencent Inc.

Q [LEGO.com/devicecheck](https://LEGO.com/devicecheck)

**EN** Ask parents' permission before going online | **DE** Eltern um Erlaubnis bitten, bevor du online gehst | **FR** Demande l'autorisation d'un parent avant d'aller en ligne | **IT** Chiedi il permesso ai tuoi genitori prima di andare online | **ES** Pídeles permiso a tus papás antes de conectarte a Internet | **PT** Pede autorização aos pais antes de acederes online | **ZH** 上网前应先征得父母的同意 | **PL** Poproś rodziców o zgodę, zanim wejdiesz do Internetu | **CS** Než půjdeš na internet, požádej rodiče o svolení | **SK** Skôr než pôjdeš na internet, vypýtaj si povolenie od rodičov | **HU** Kérj szülői engedélyt, mielőtt online csatlakoznál! | **RO** Cere permisiunea părinților înainte de a te conecta online | **BG** Поискайте разрешение от родител, преди да влезете онлайн | **LV** Pirms došanās tiešsaistē palūdz atļauju vecākiem | **ET** Enne Interneti kasutamist küsi vanematelt luba | **LT** Prieš prisijungdami prie interneto, atsiklauskite tėvų











1x



1x

1



2x

2

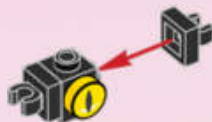

1x

3







4

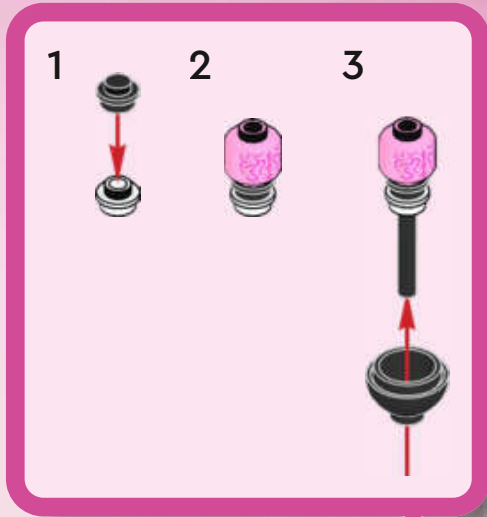



1x

5



2x

6



10



4x



4x

7

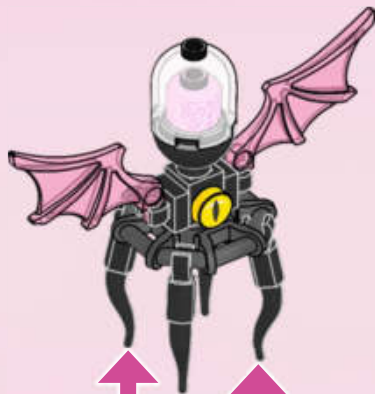

4x







1x



1x

1

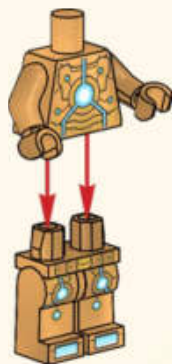



2

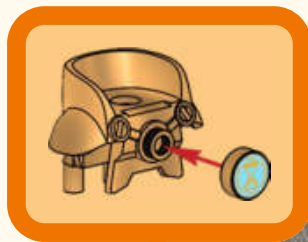



1x



1x

3

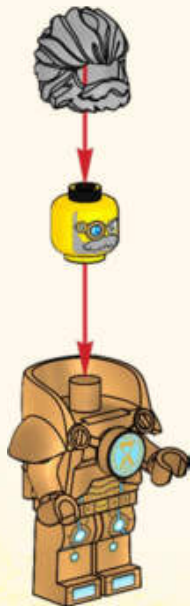

1x



1x

4





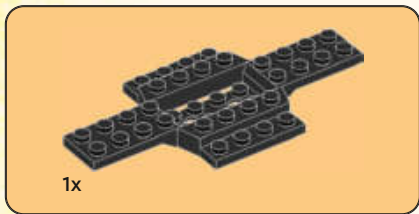

1

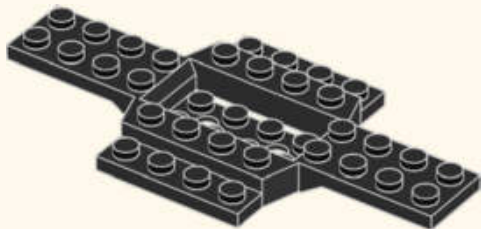



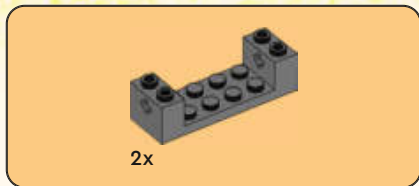

2

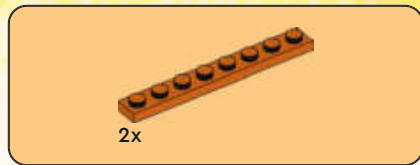
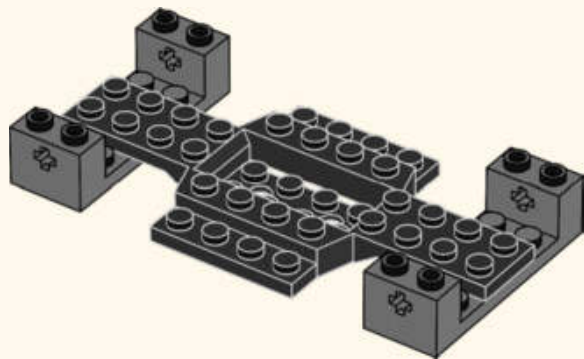

3

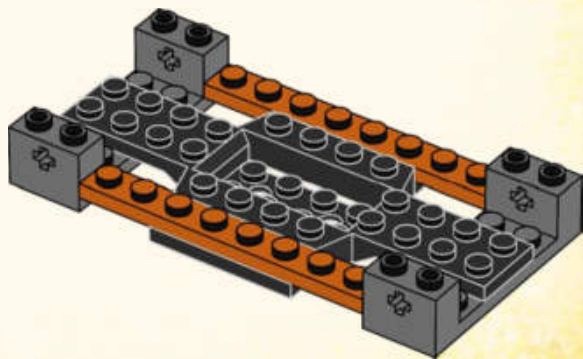



2x

4

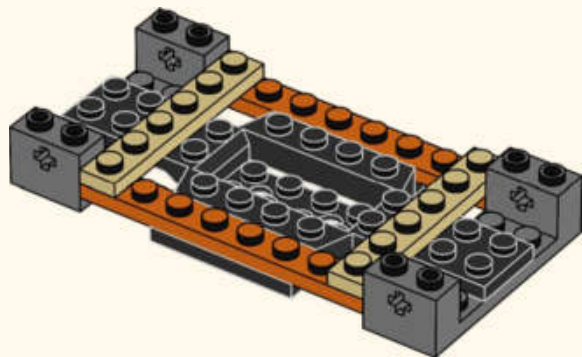

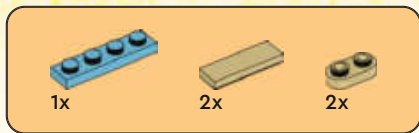

5

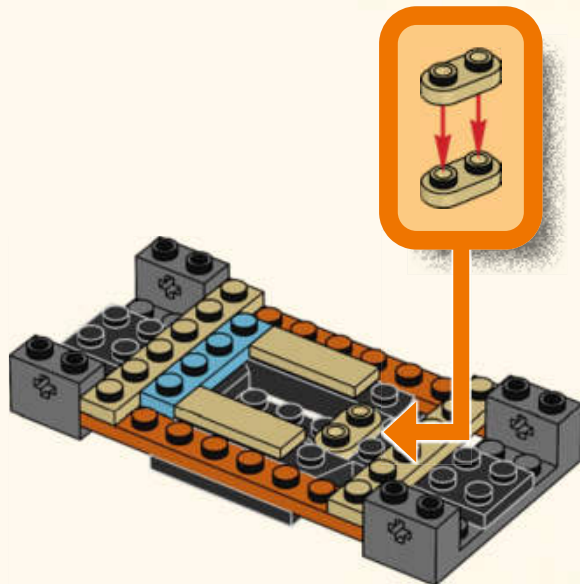



6x



6x

6

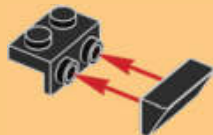

6x

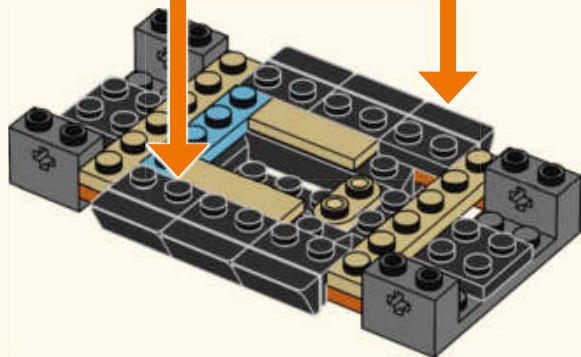

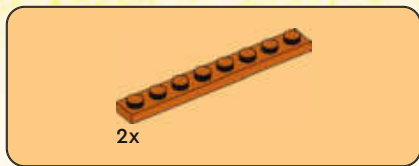

7

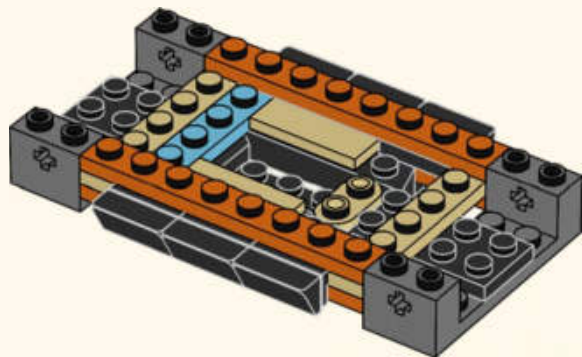

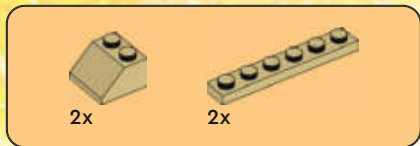

8

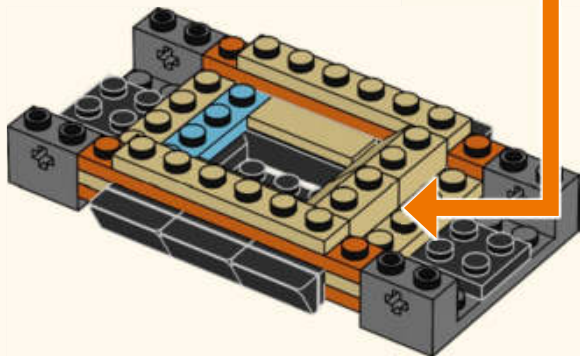
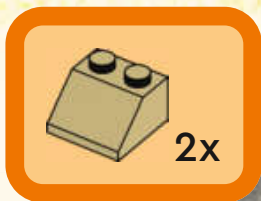

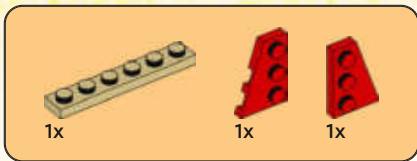

9

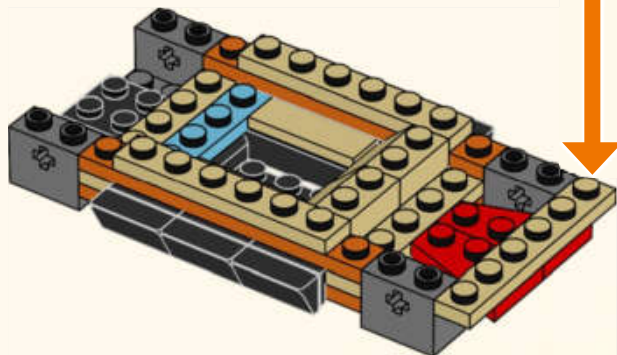
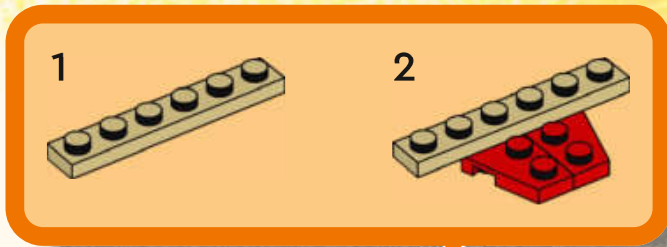



2x

10

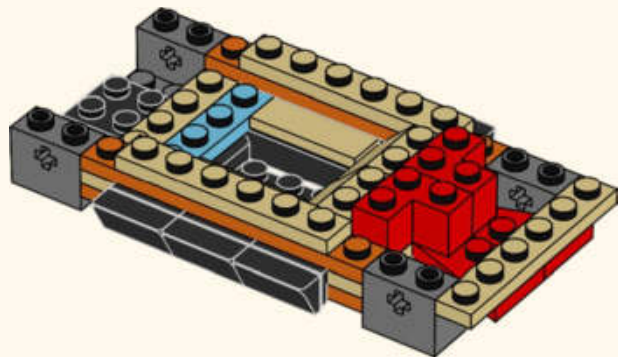





2x

11

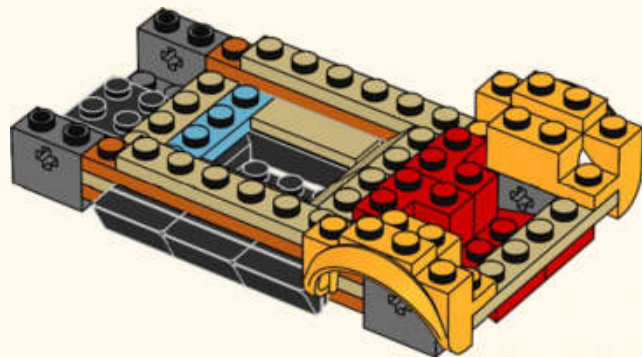

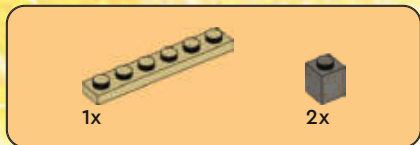

12

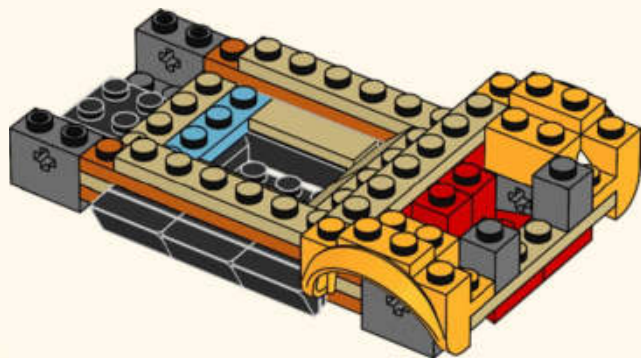

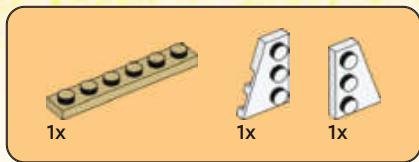

13

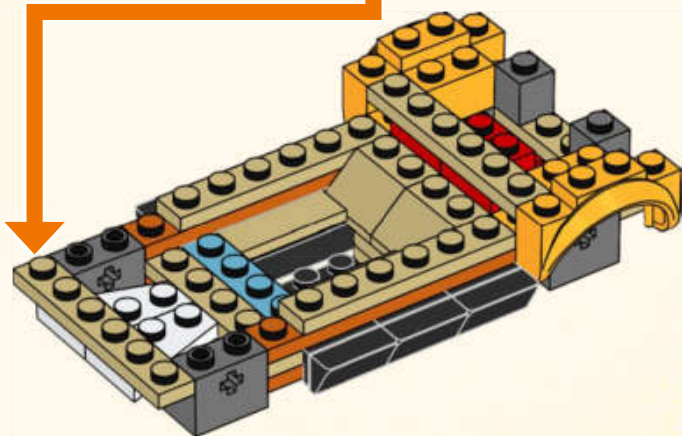
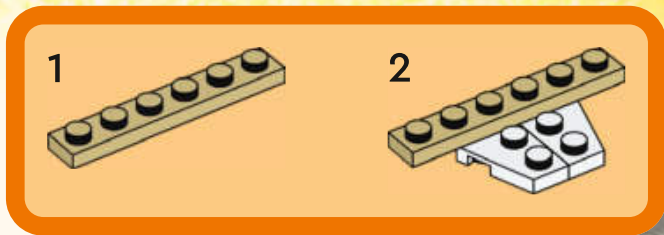



2x



1x

14

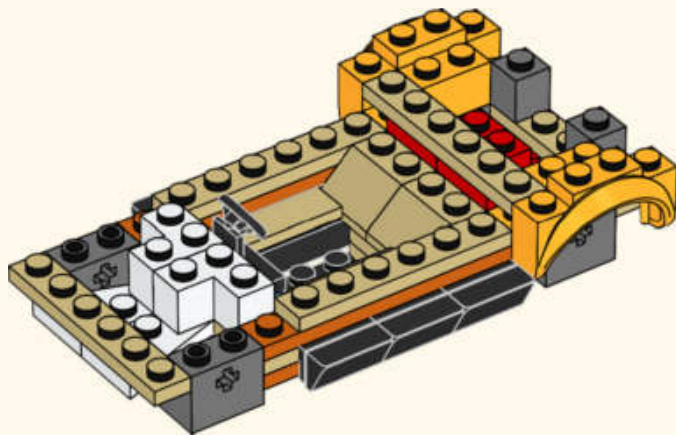



2x

15

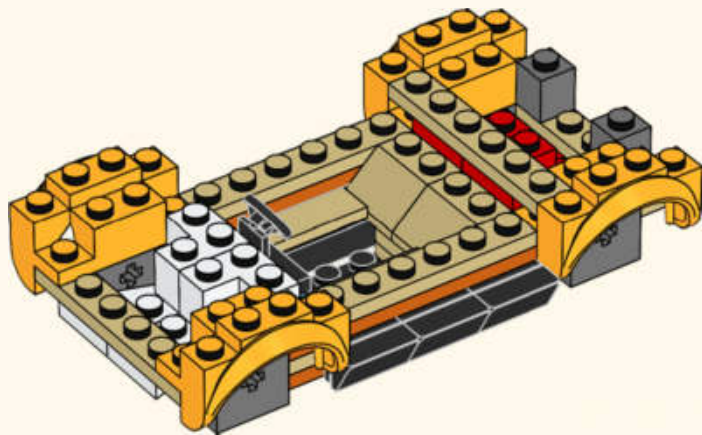



16

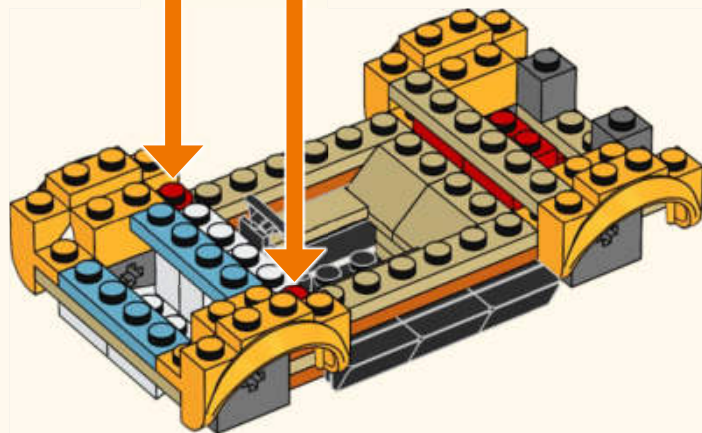



17

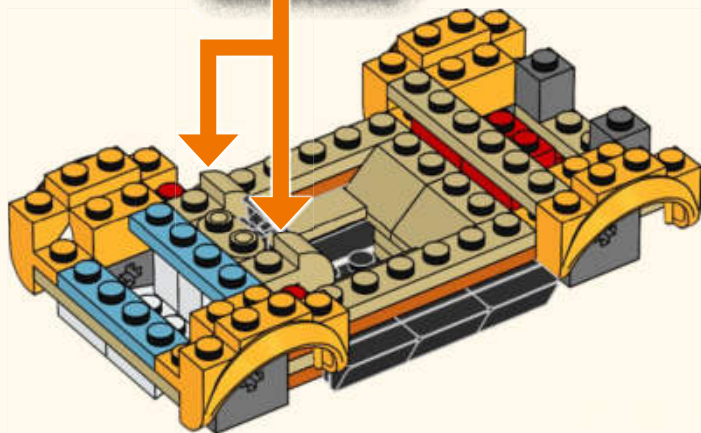
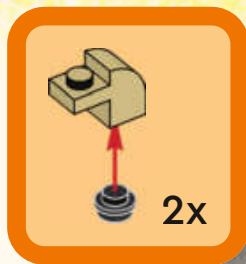

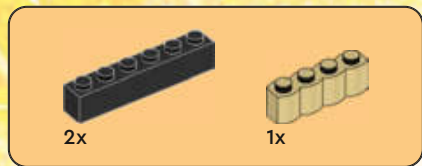

18

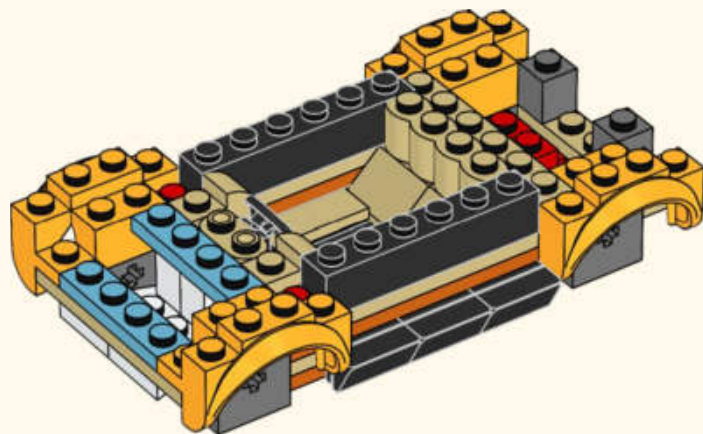





2x

19

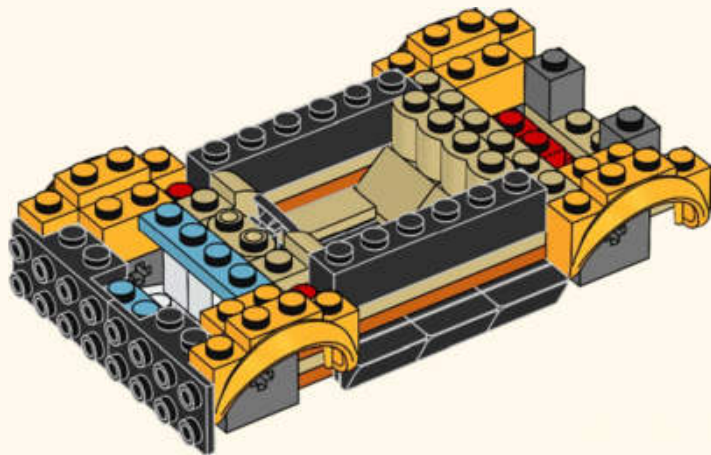



1x



1x



2x



2x

# 20

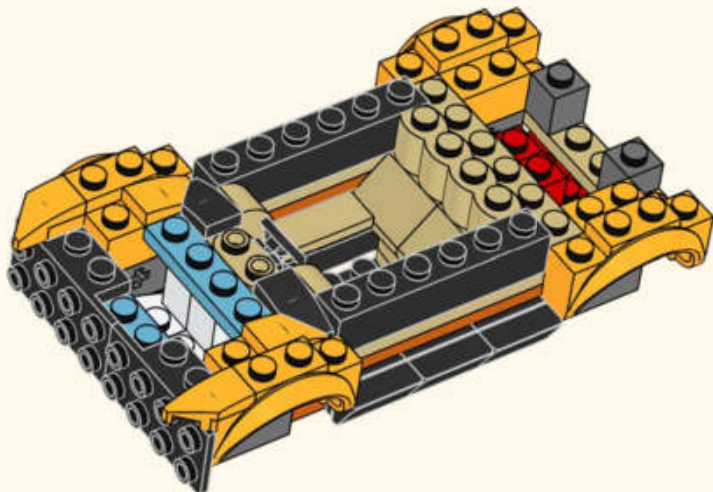





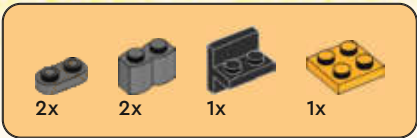

21

1

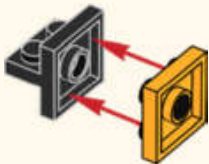

2

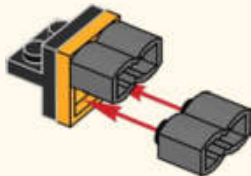

3

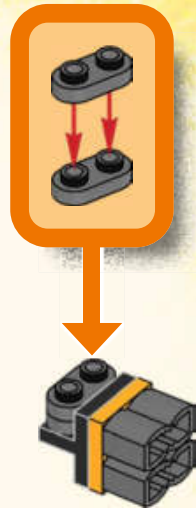

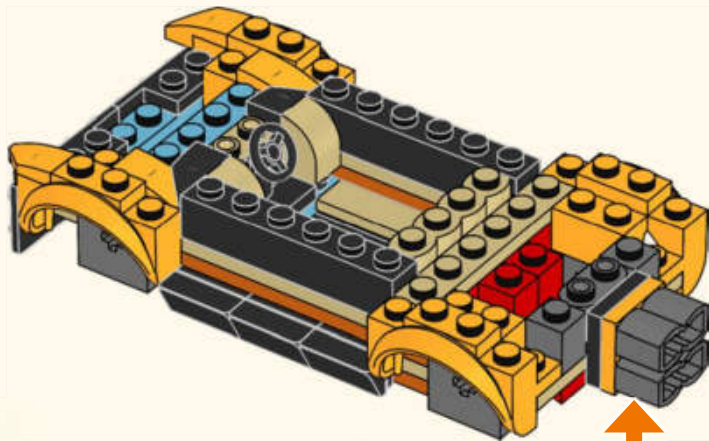

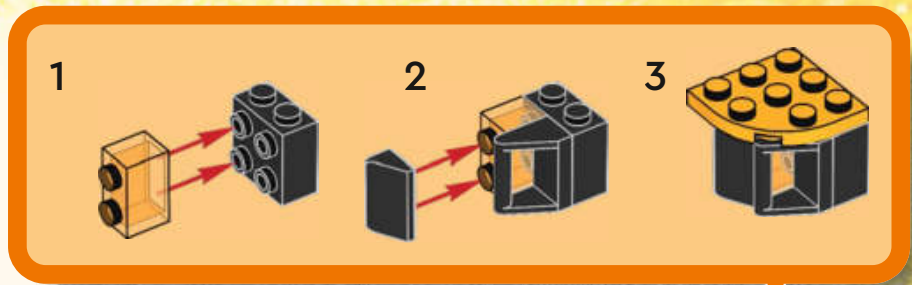

22

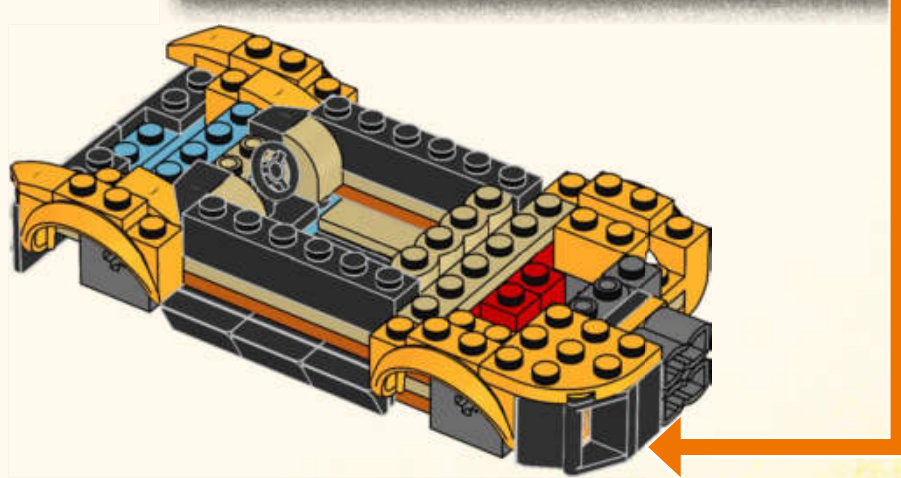



23

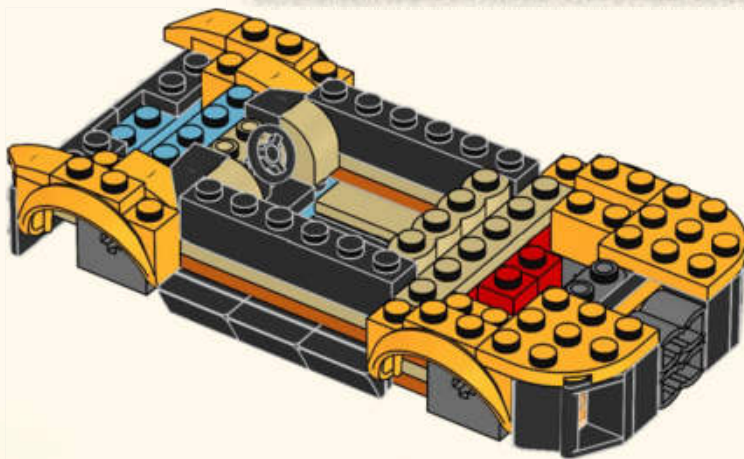
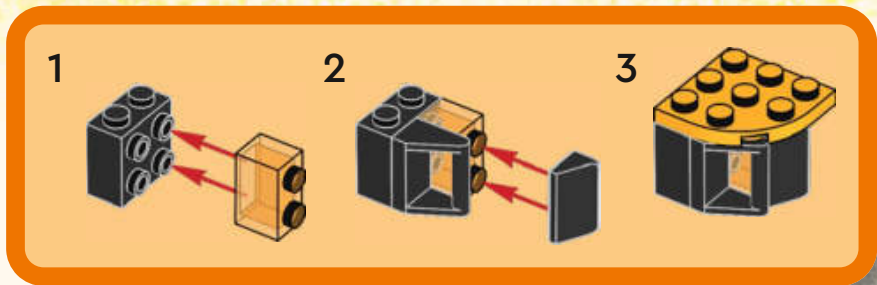





2x

24

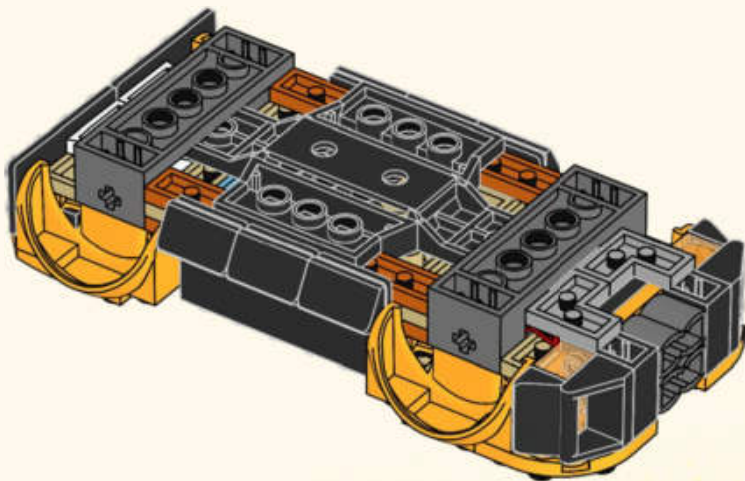



2x

25

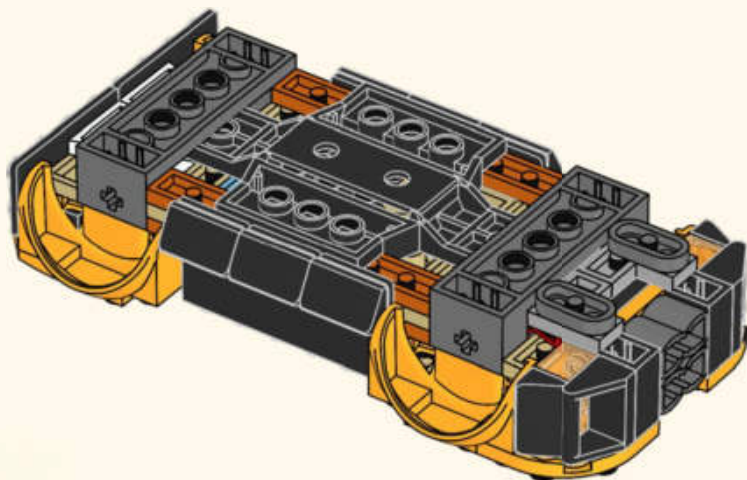



2x

26

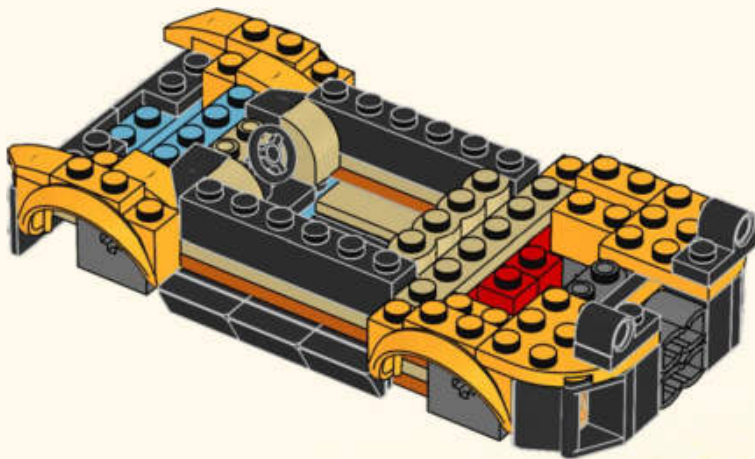



27

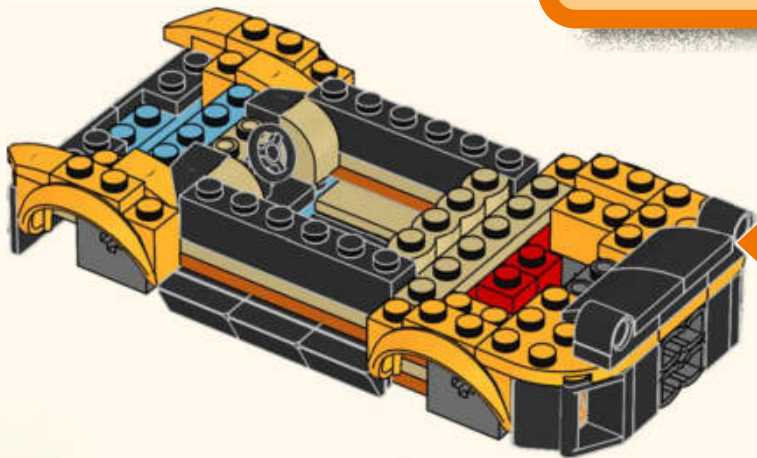
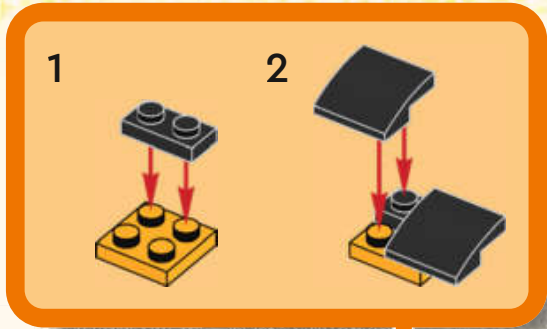



1x



2x

28

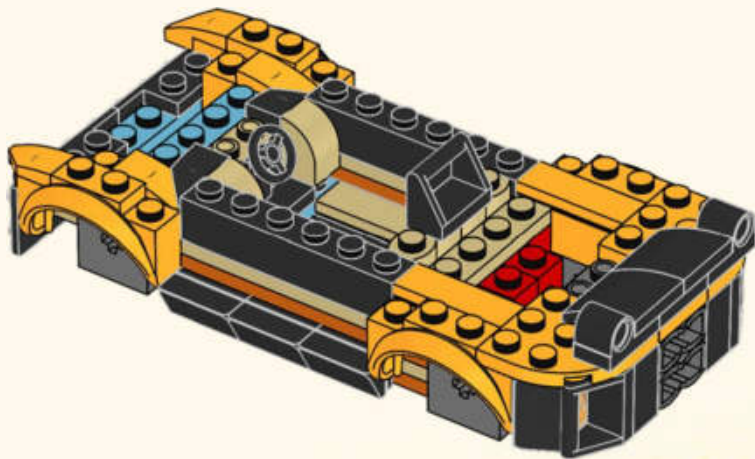



29

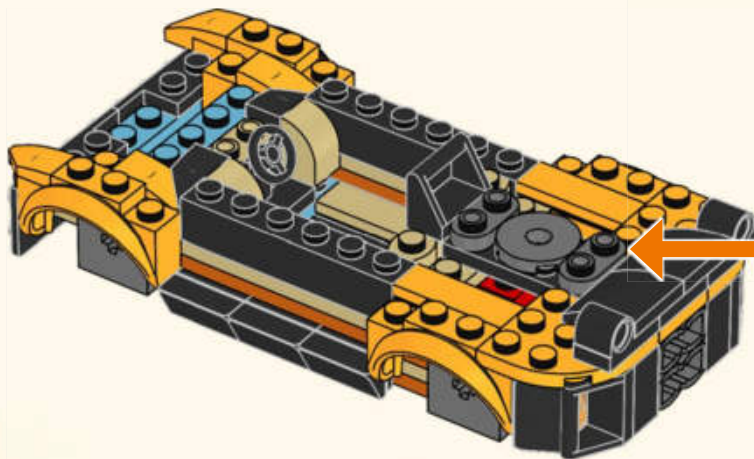
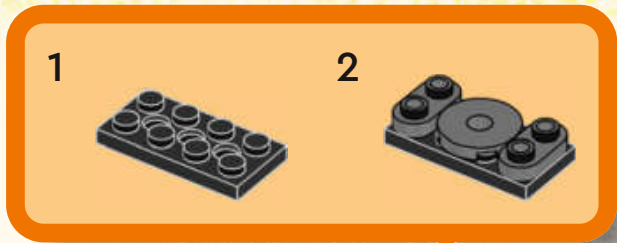



30

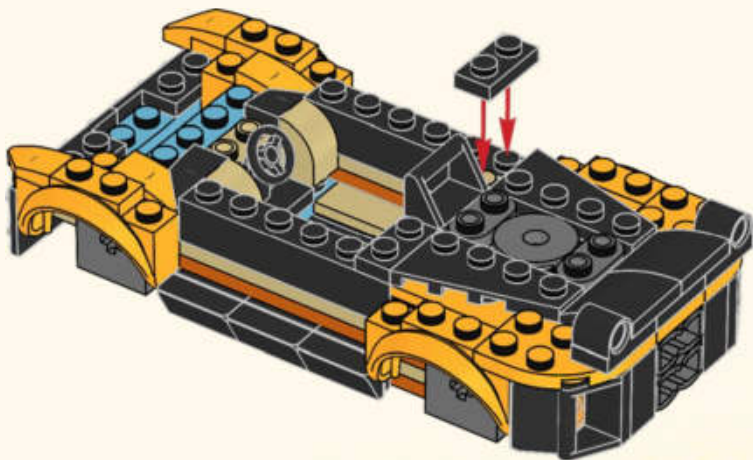

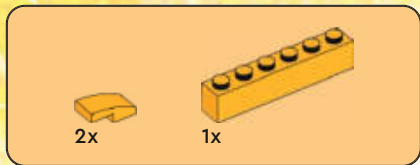

31

1

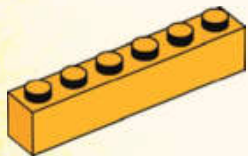

2

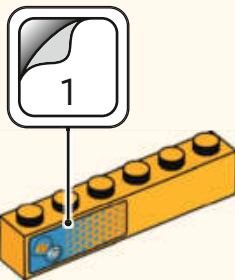

3

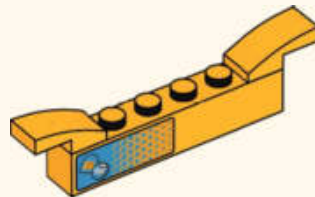



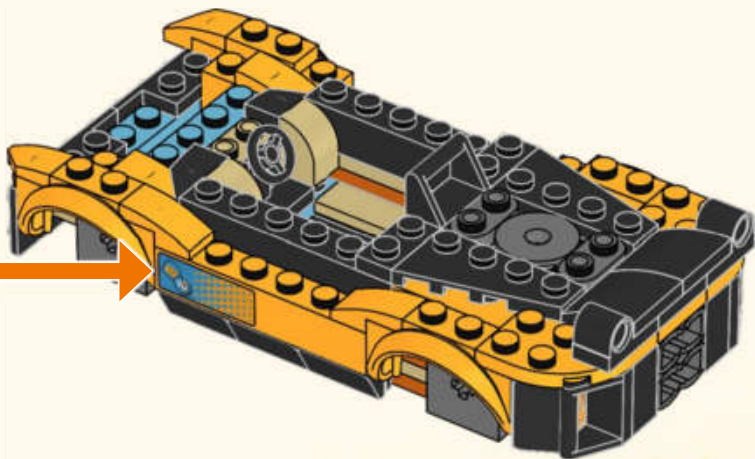

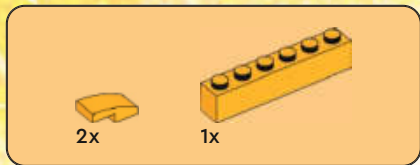

32

1

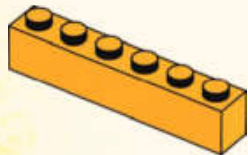

2

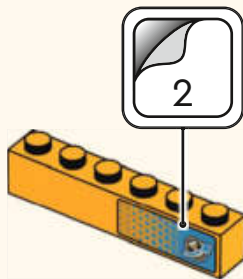

3

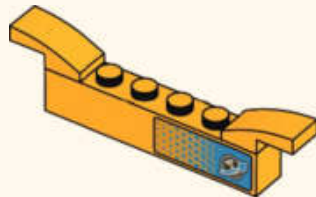

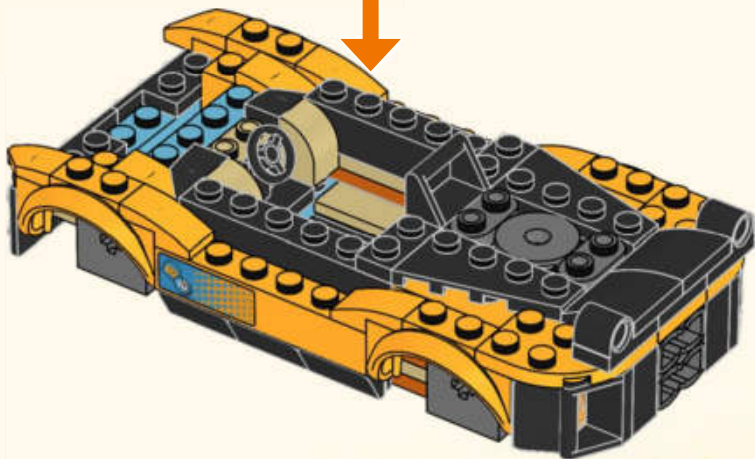



1x



1x

# 33

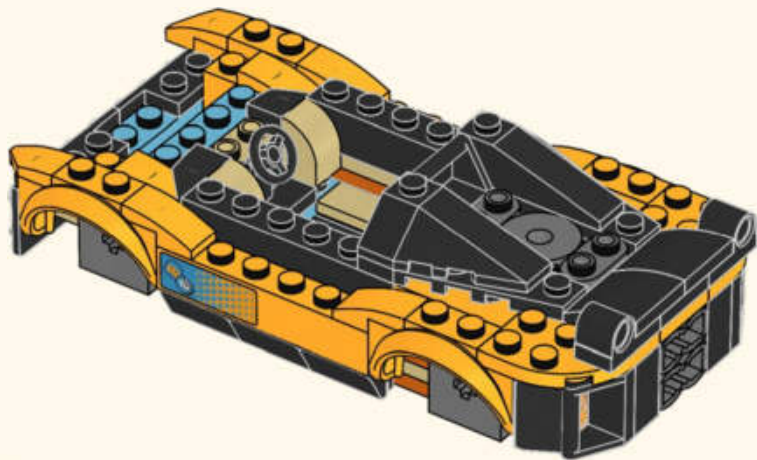



1x

34

1



2

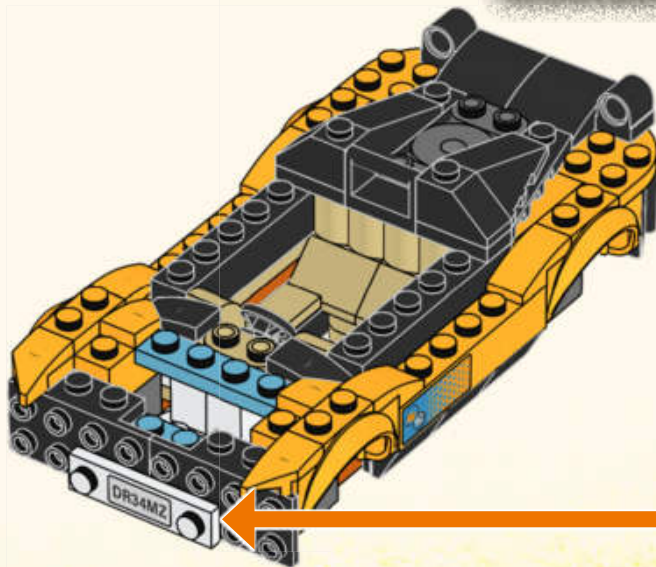
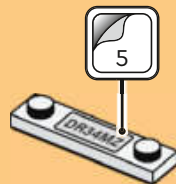

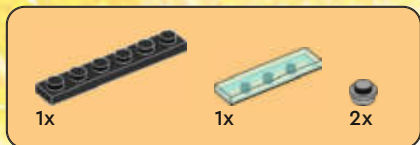

35

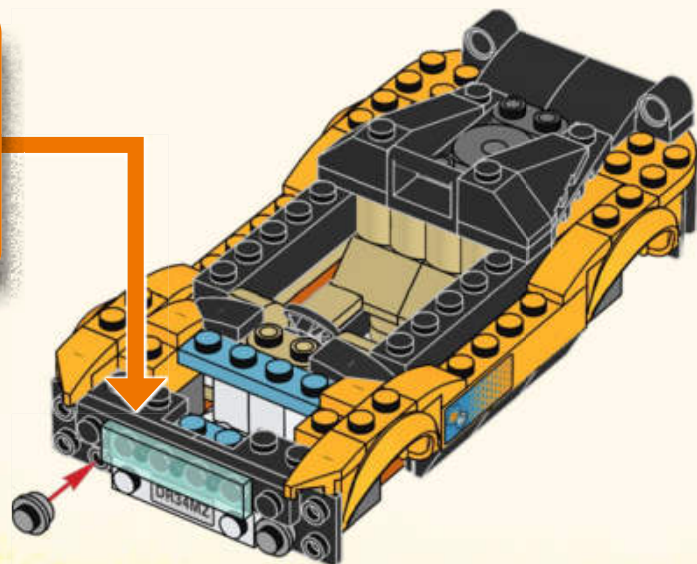
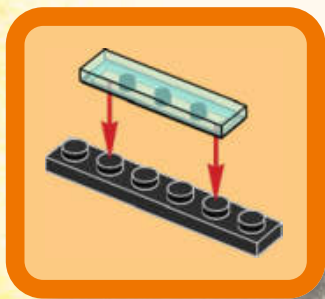



4x



2x

# 36

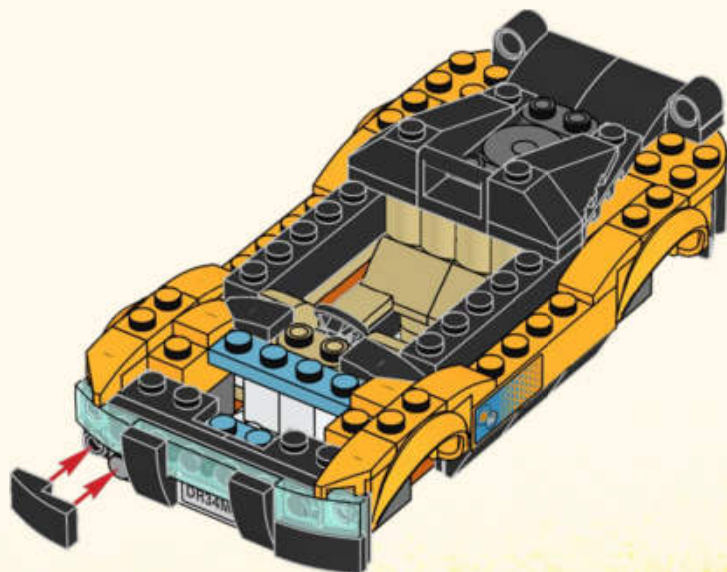



2x



2x

37

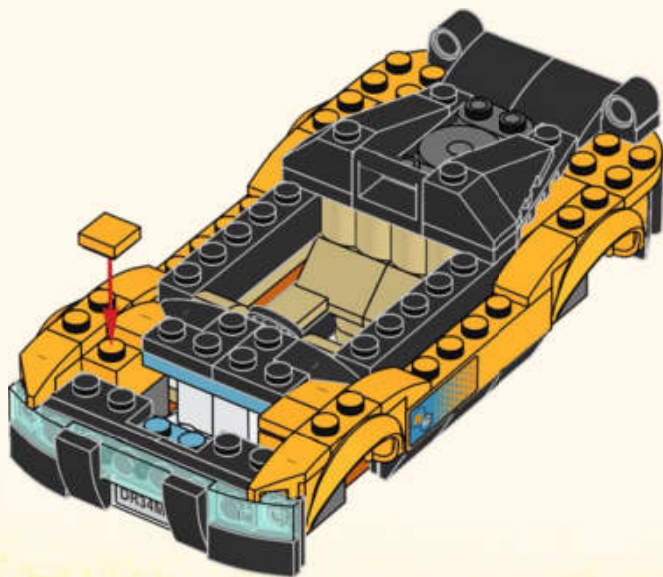





38

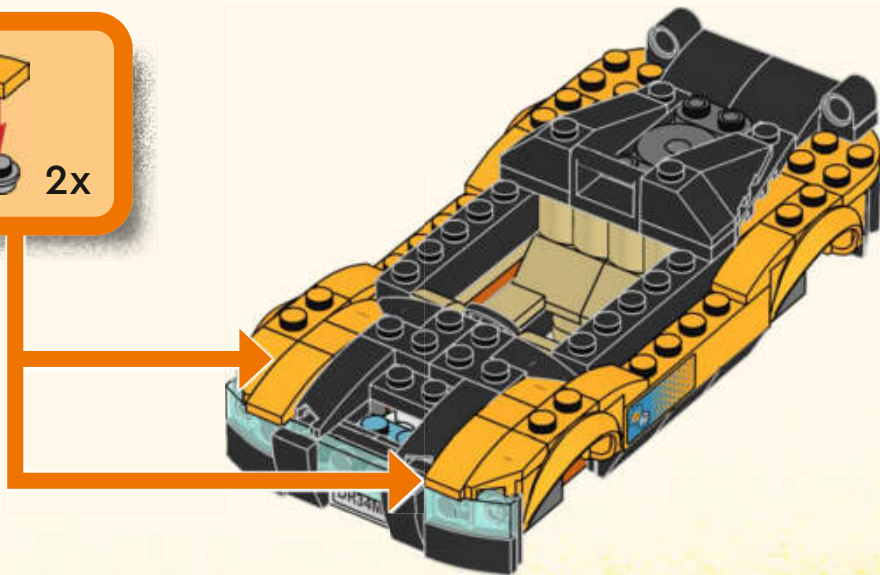
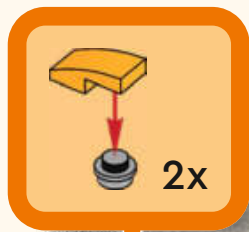



39

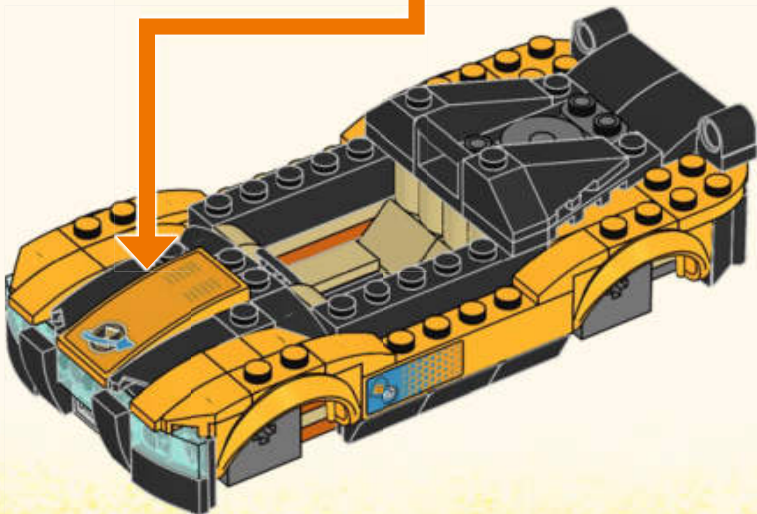
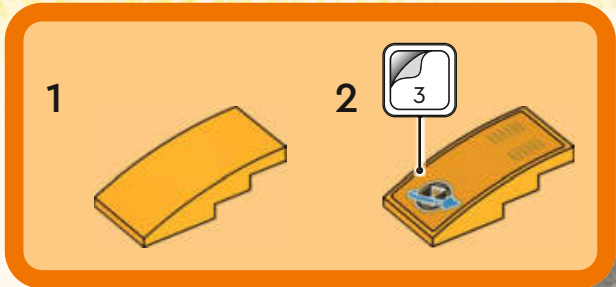



40

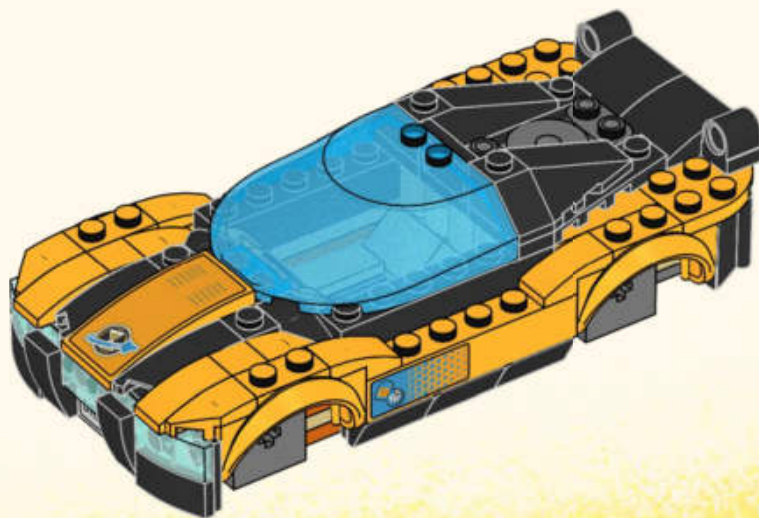



41

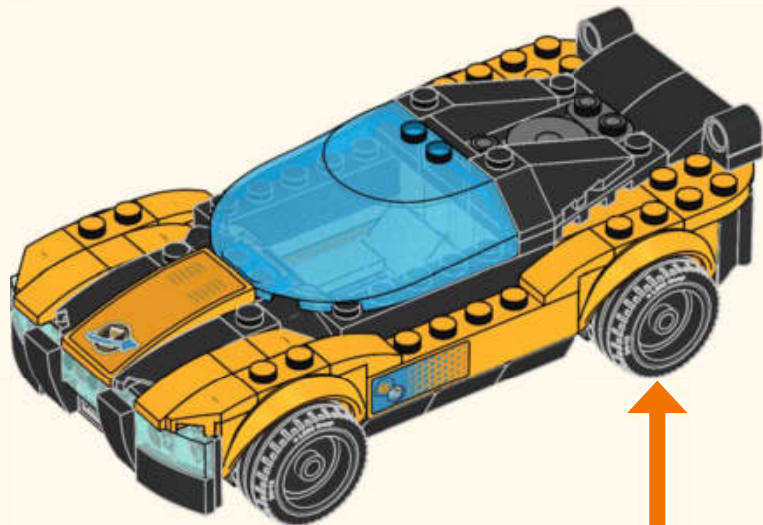
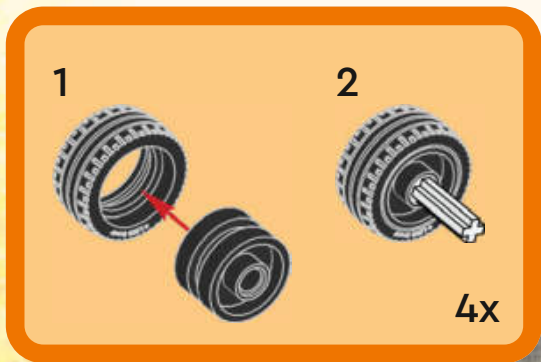



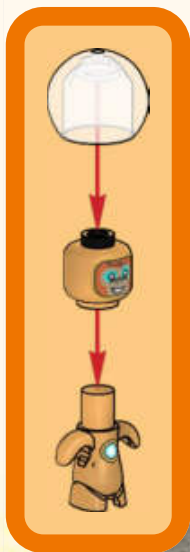

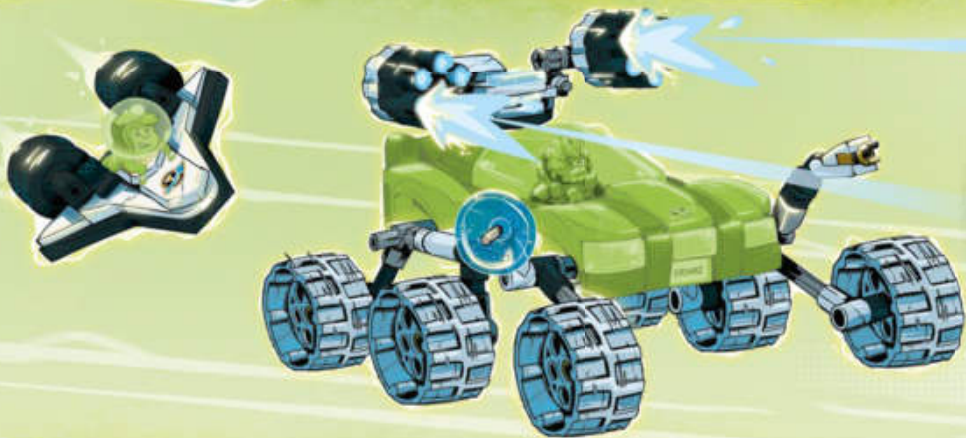

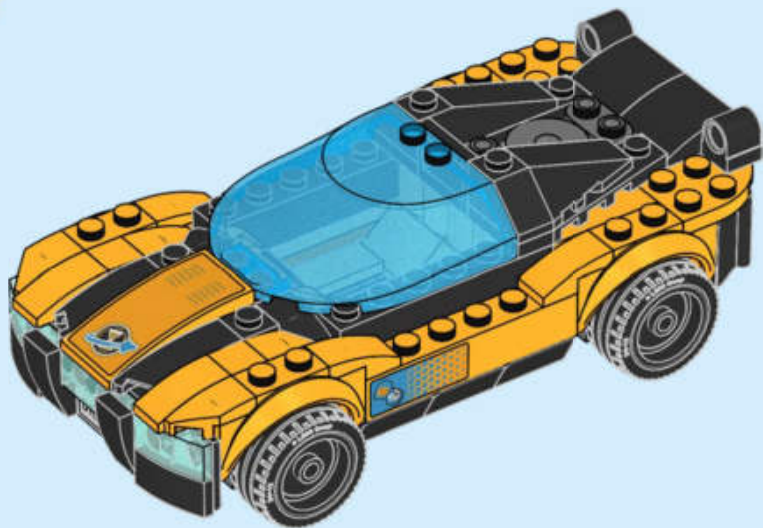



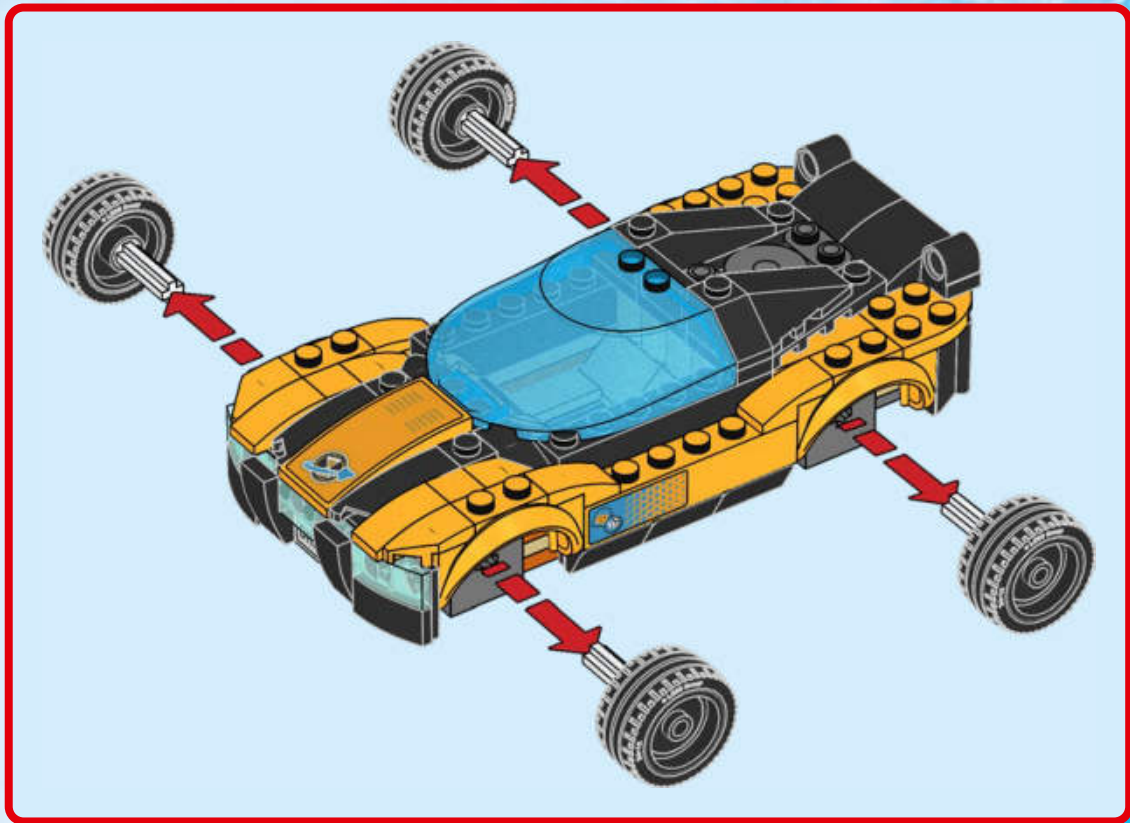

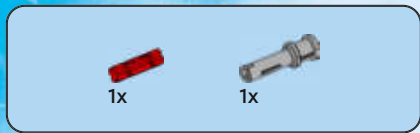

1

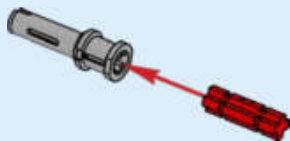

2

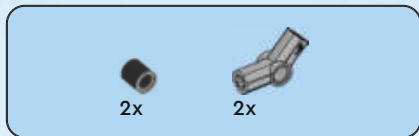

3

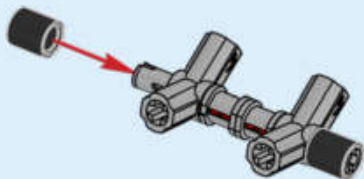



1x



1x

4

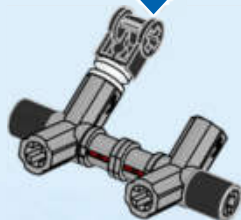
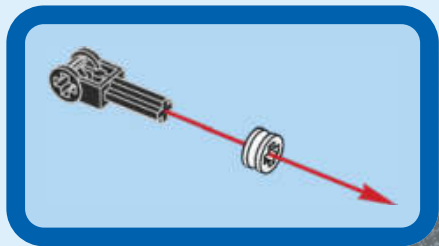

1x

5

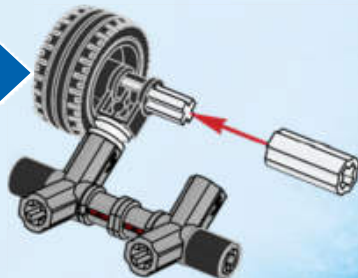



1x



1x

6

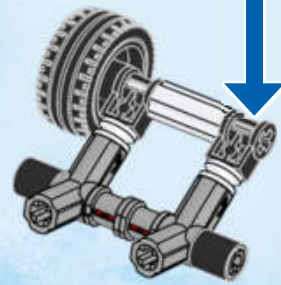
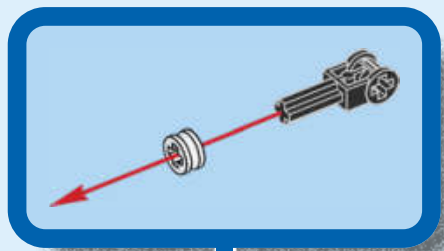

7

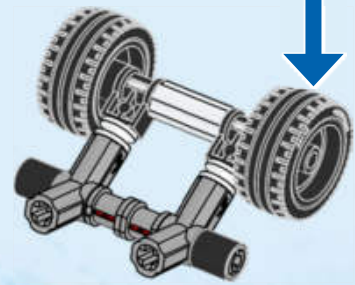

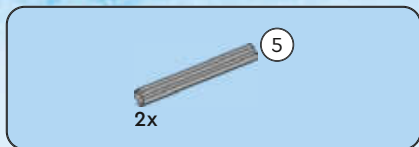

8

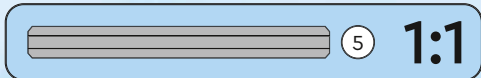
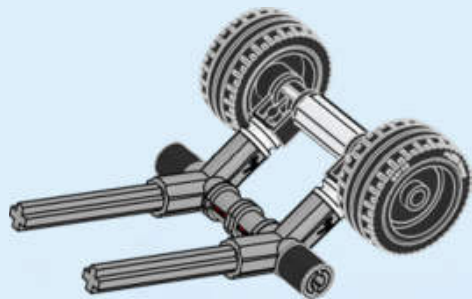

9

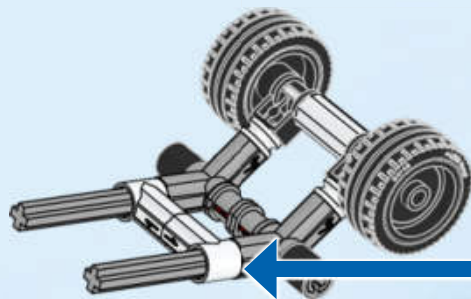
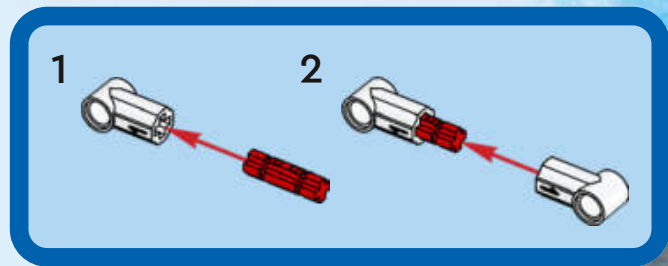



2x



1x



1x

# 10

1



2



3

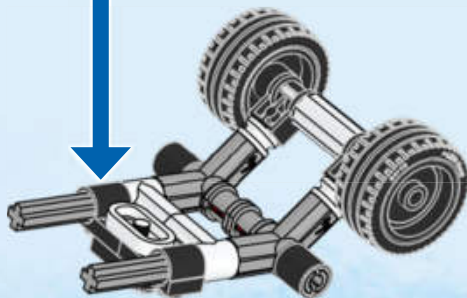



1x



2x

# 11

1

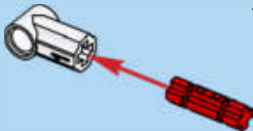

2

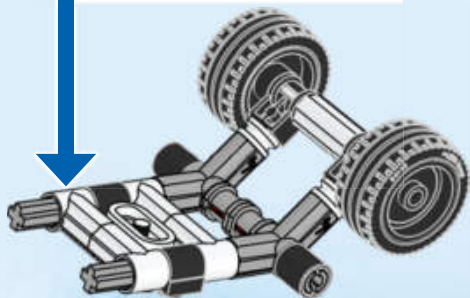
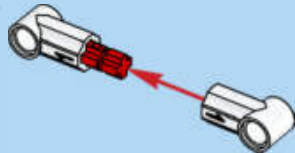

1x

# 12

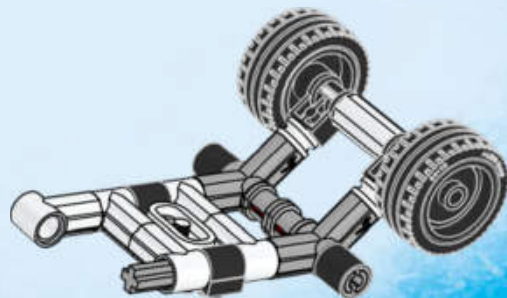



1x

13

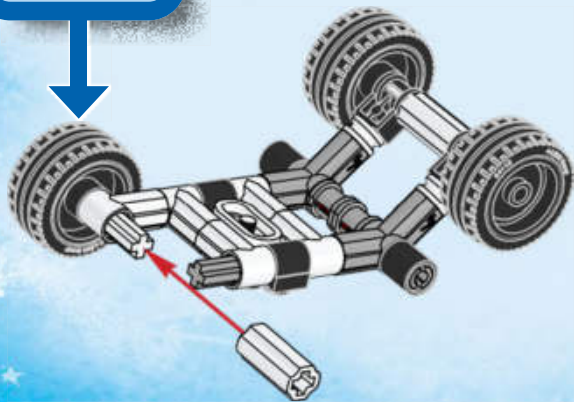

1x

14

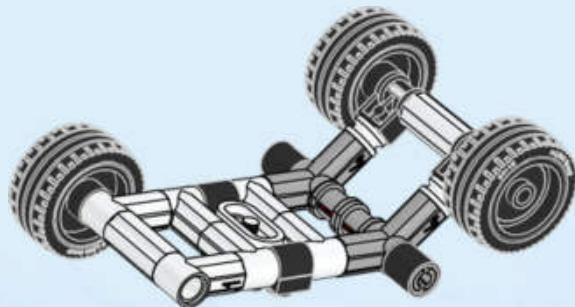



15

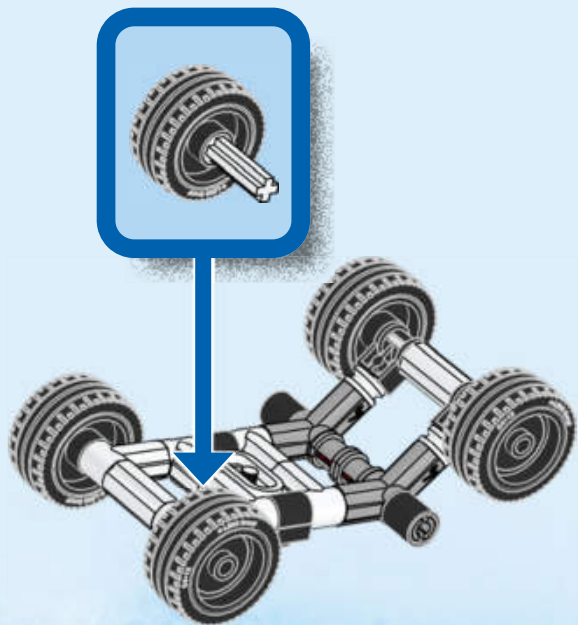

16

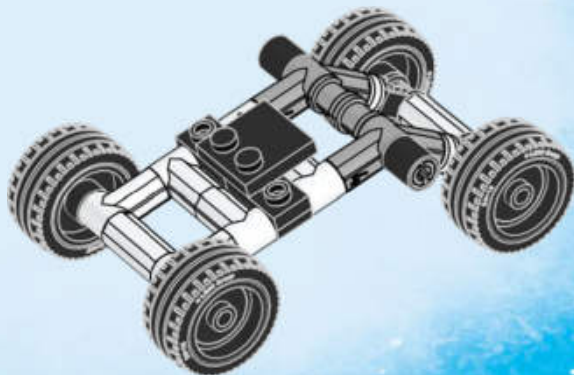

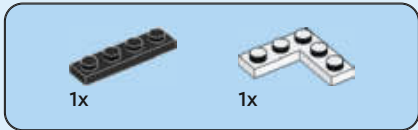
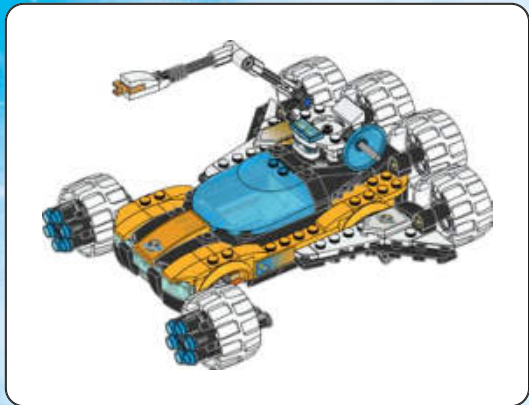

1

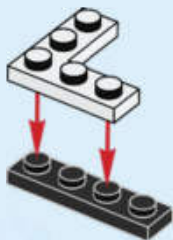



2

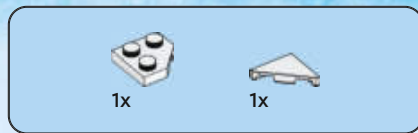

3



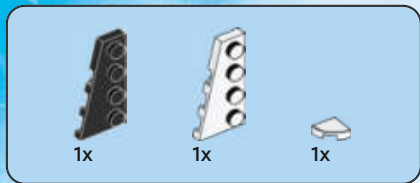

4

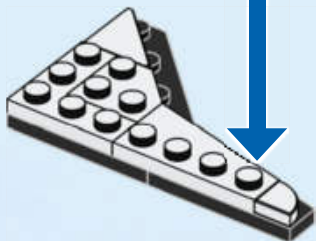
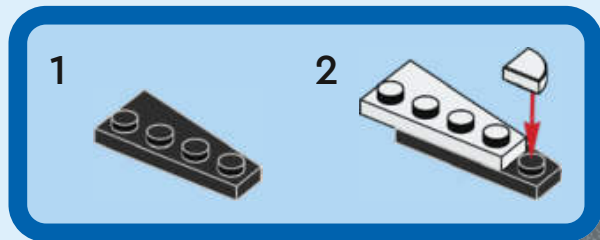



5

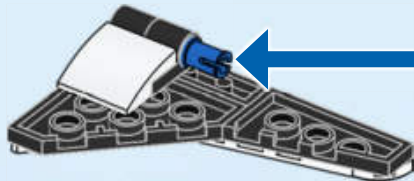
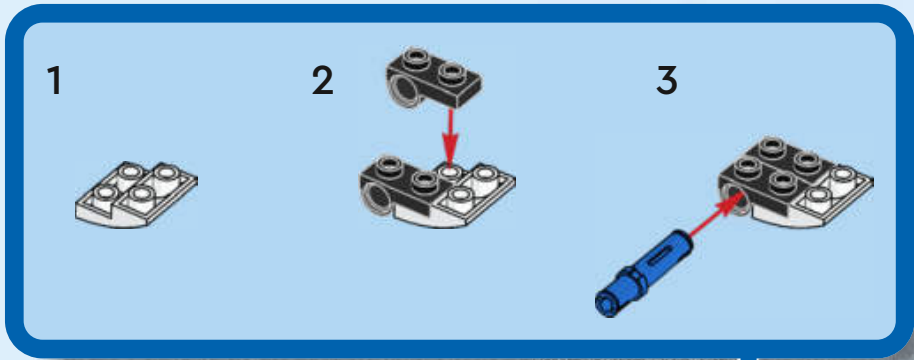

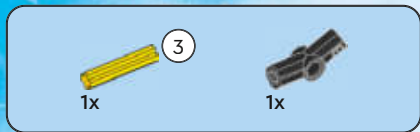

6

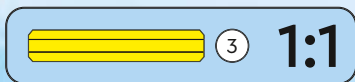
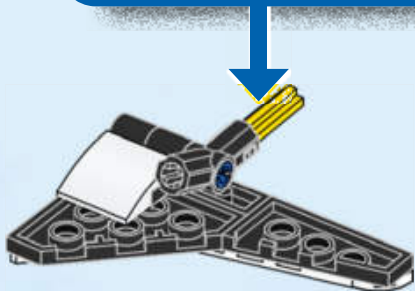
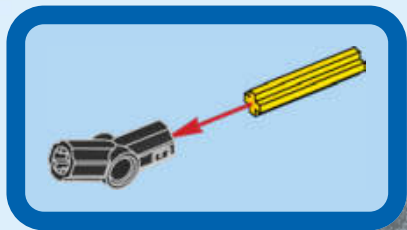

7

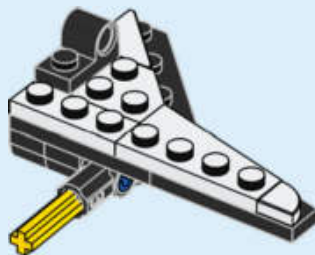



1x



1x

8

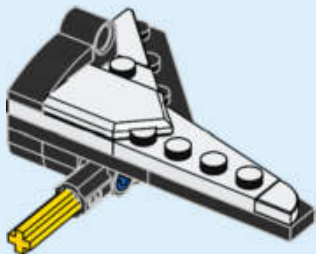

9

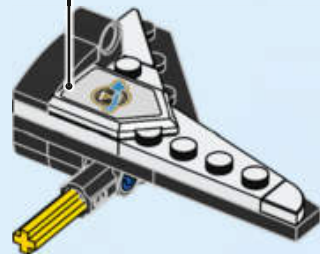

10

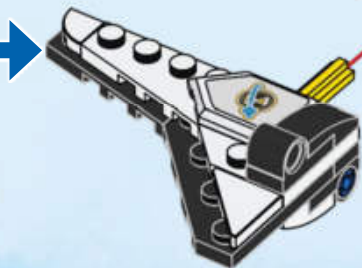
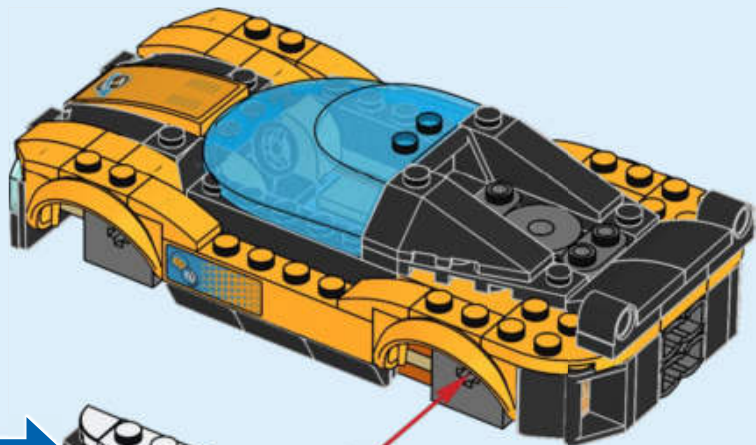



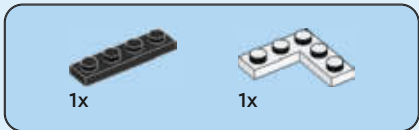

11

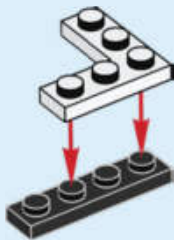

12





1x



1x

# 13



1x



1x



1x

# 14

1

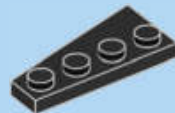

2

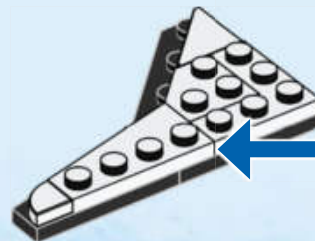
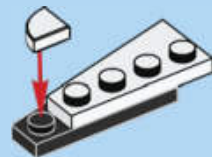



15

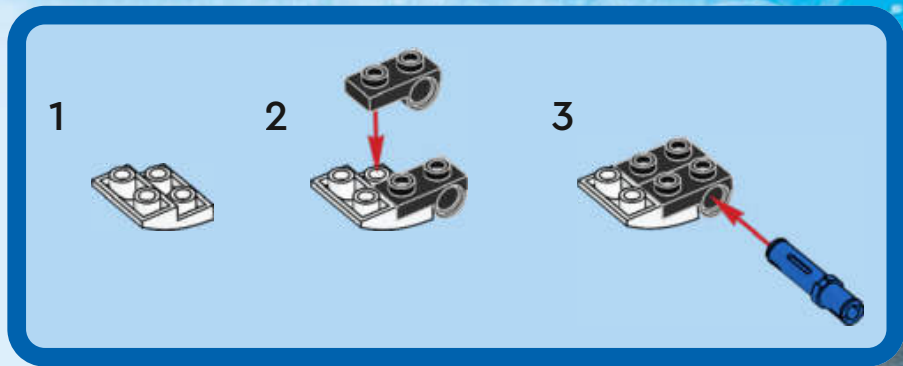



16

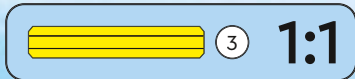
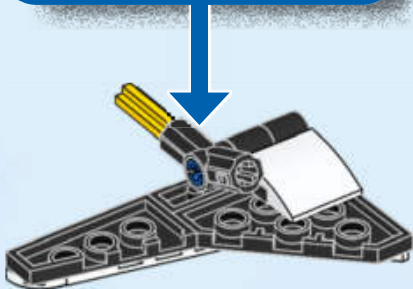
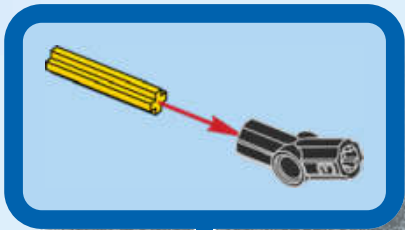

17

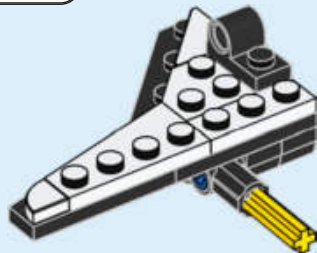



1x



1x

18

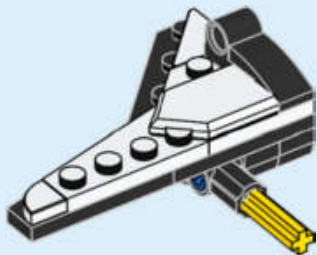

19

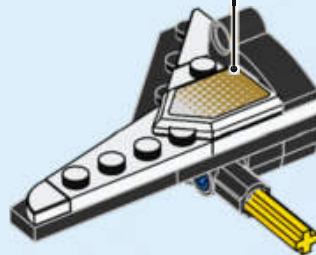

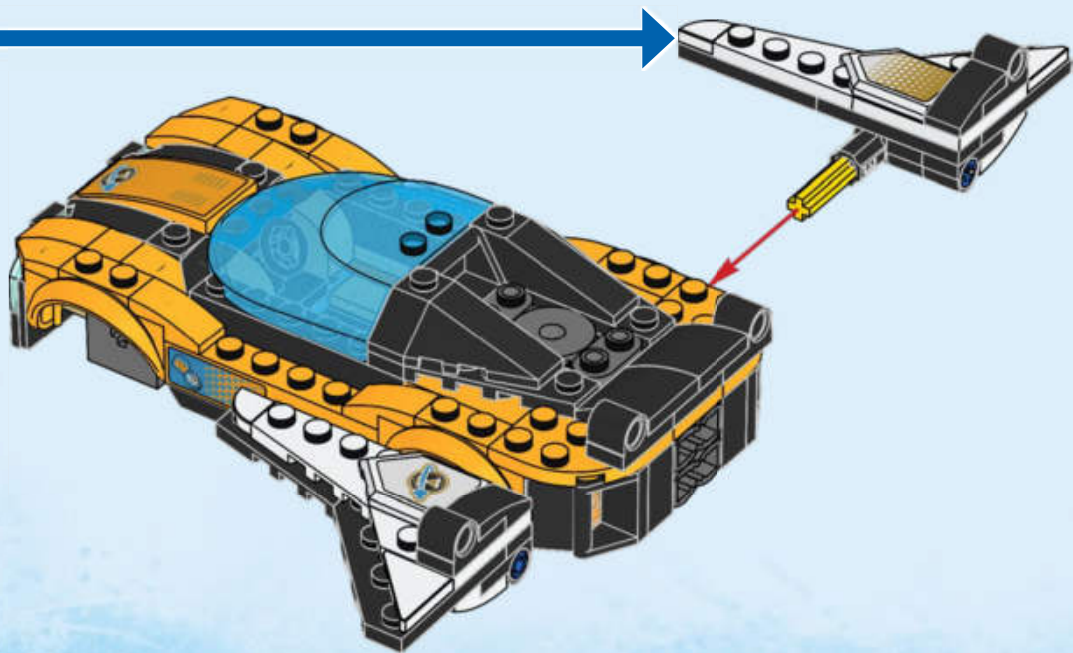

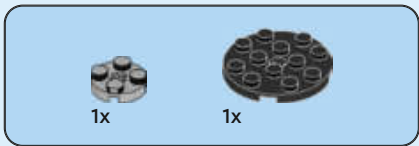

21

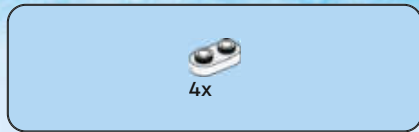
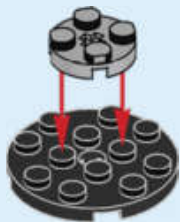

22



23





4x

24

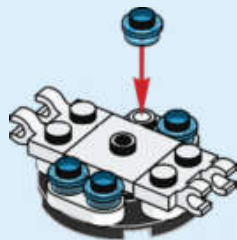

1x

25







1x



1x

# 26



# 27





1x

28

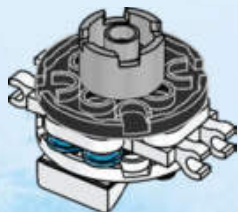

1x



1x



1x

29

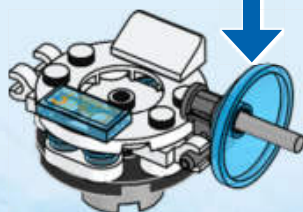
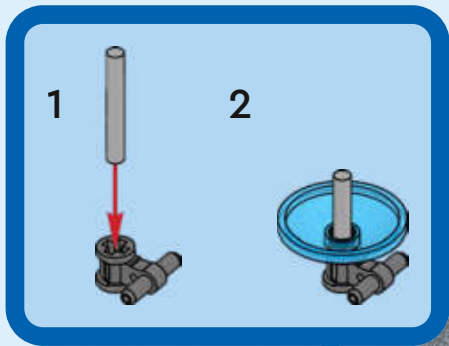



1x



1x

30

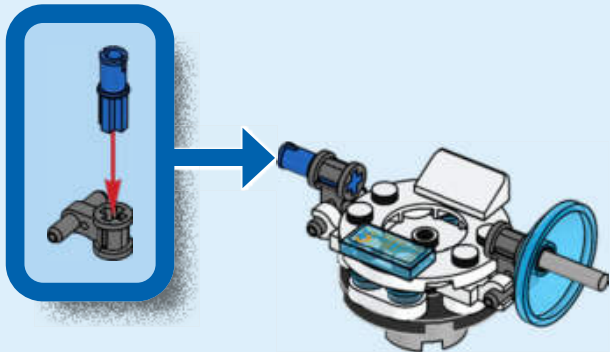

1x

31

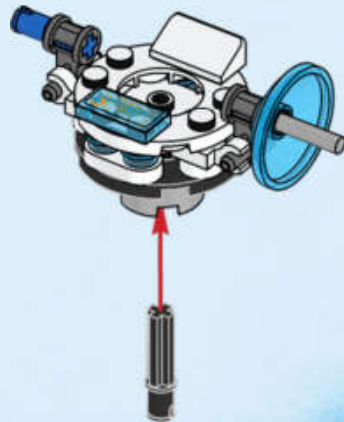

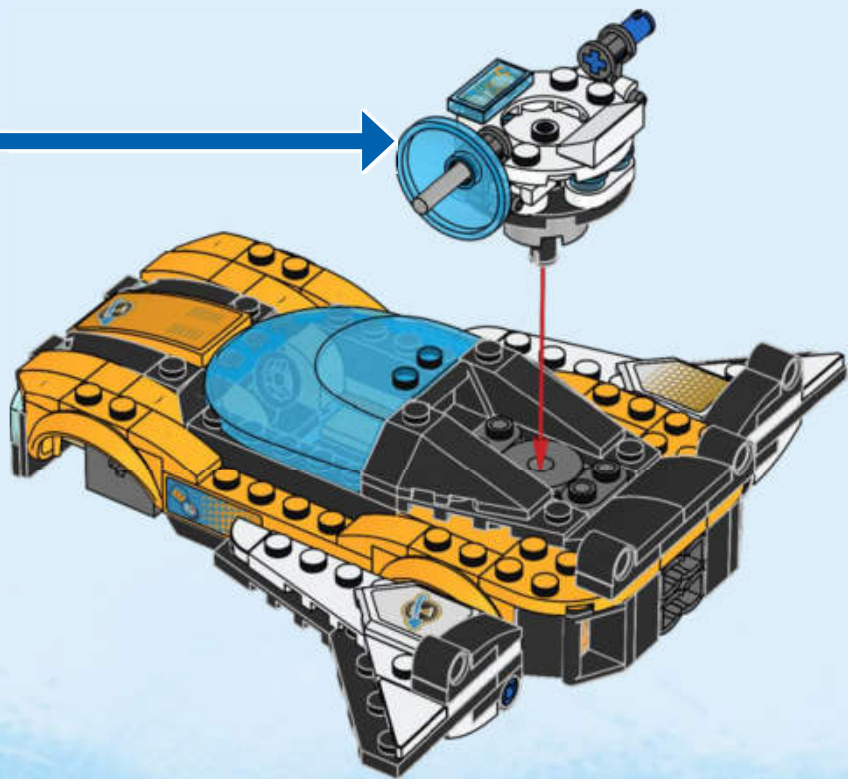



33

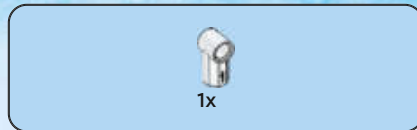
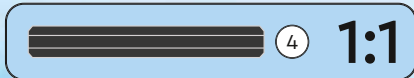

34

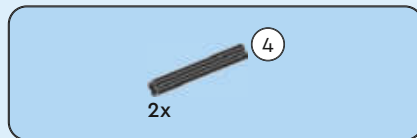

35





1x



1x

# 36

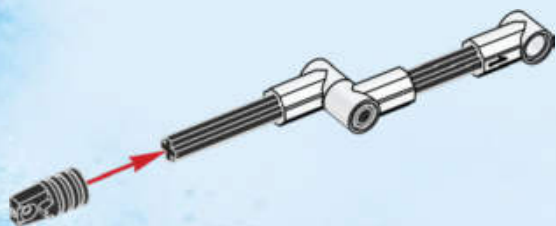

1x



1x



1x

# 37

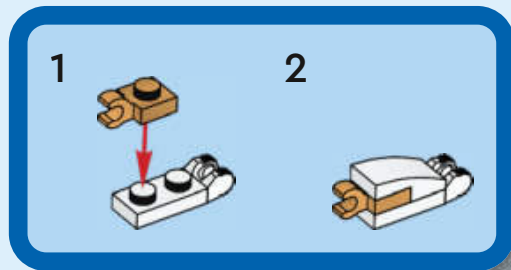

1

2

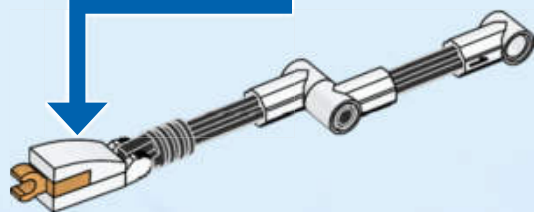

38

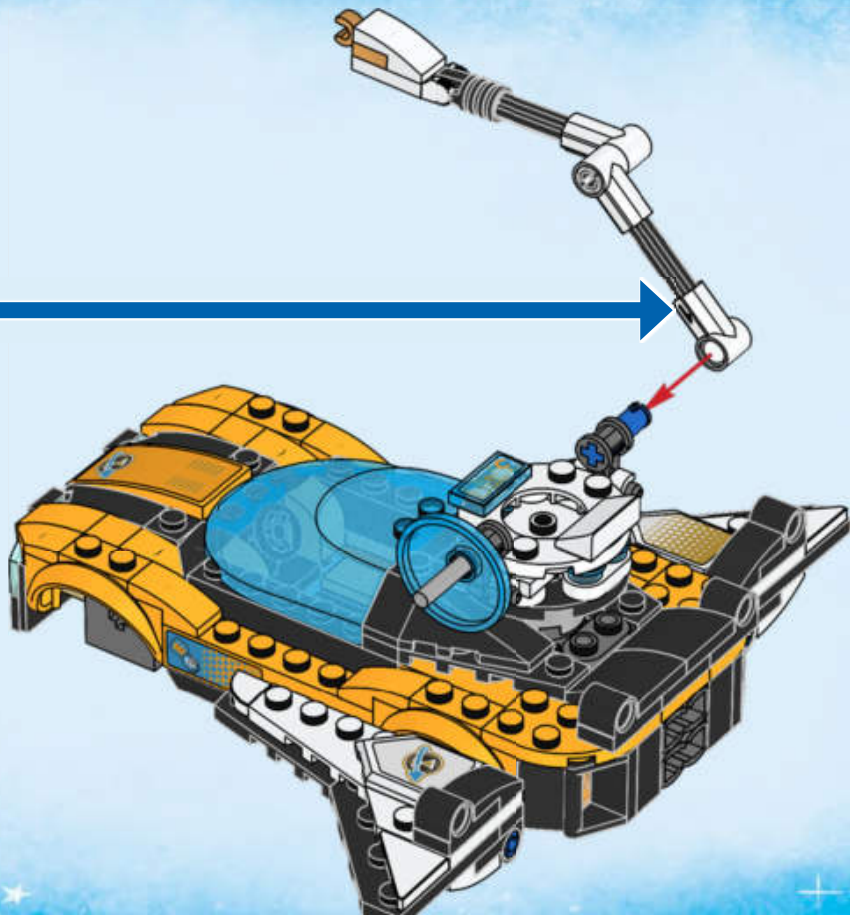



4x



4x



4x



4x



4x



4x

39

1

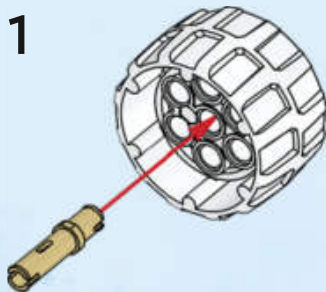

2

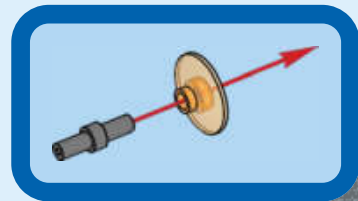
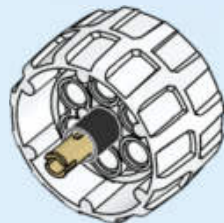

3

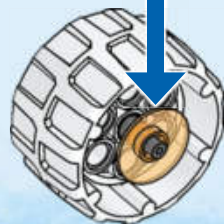

4x



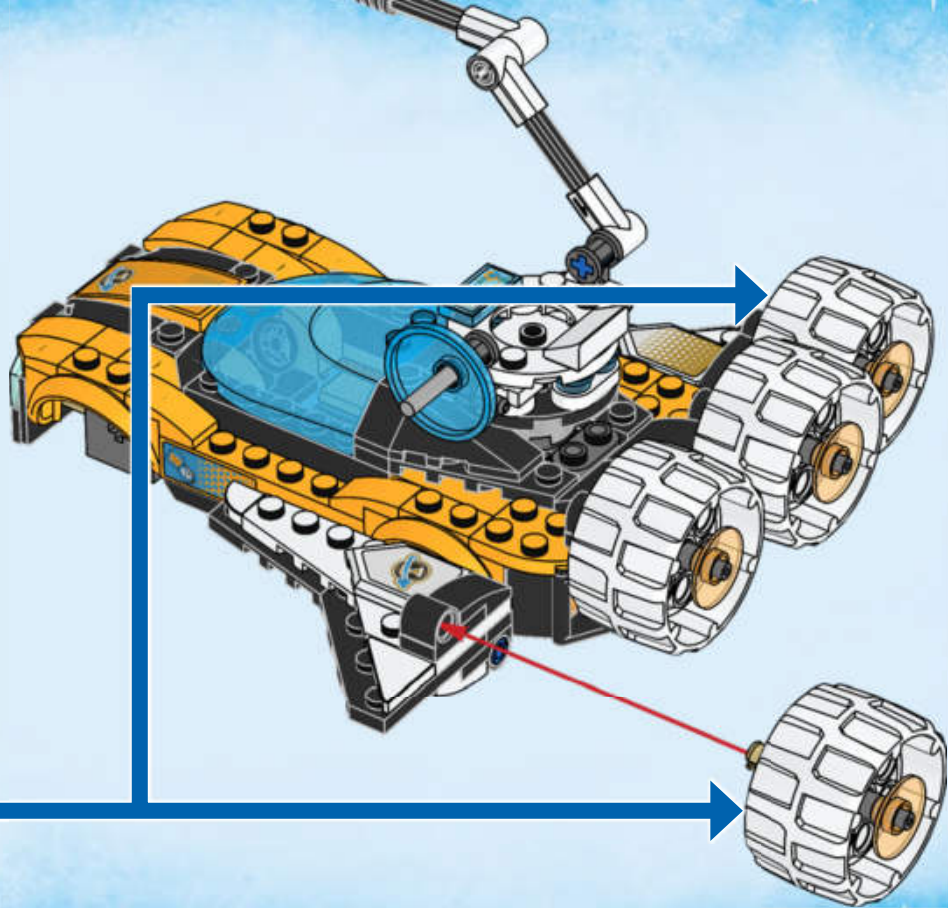



2x



1x



1x

40

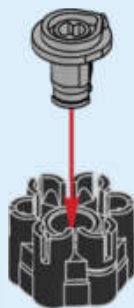



2x

41



1x

42

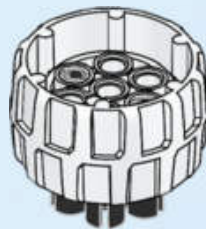

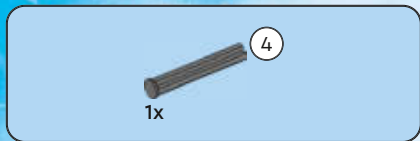

43

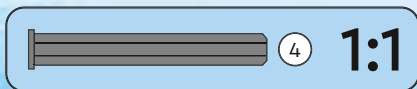
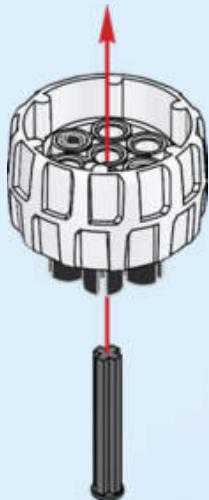

44

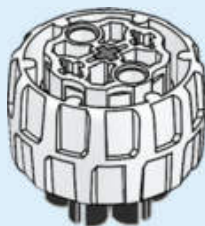



45

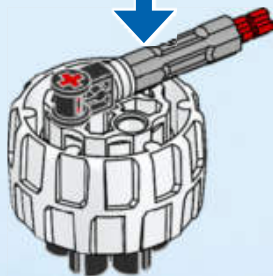
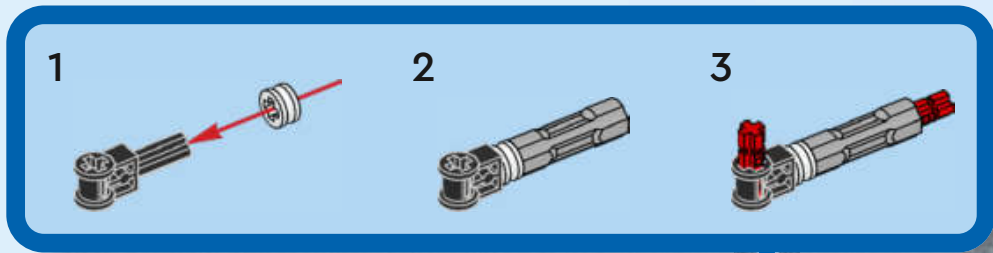

2x

46

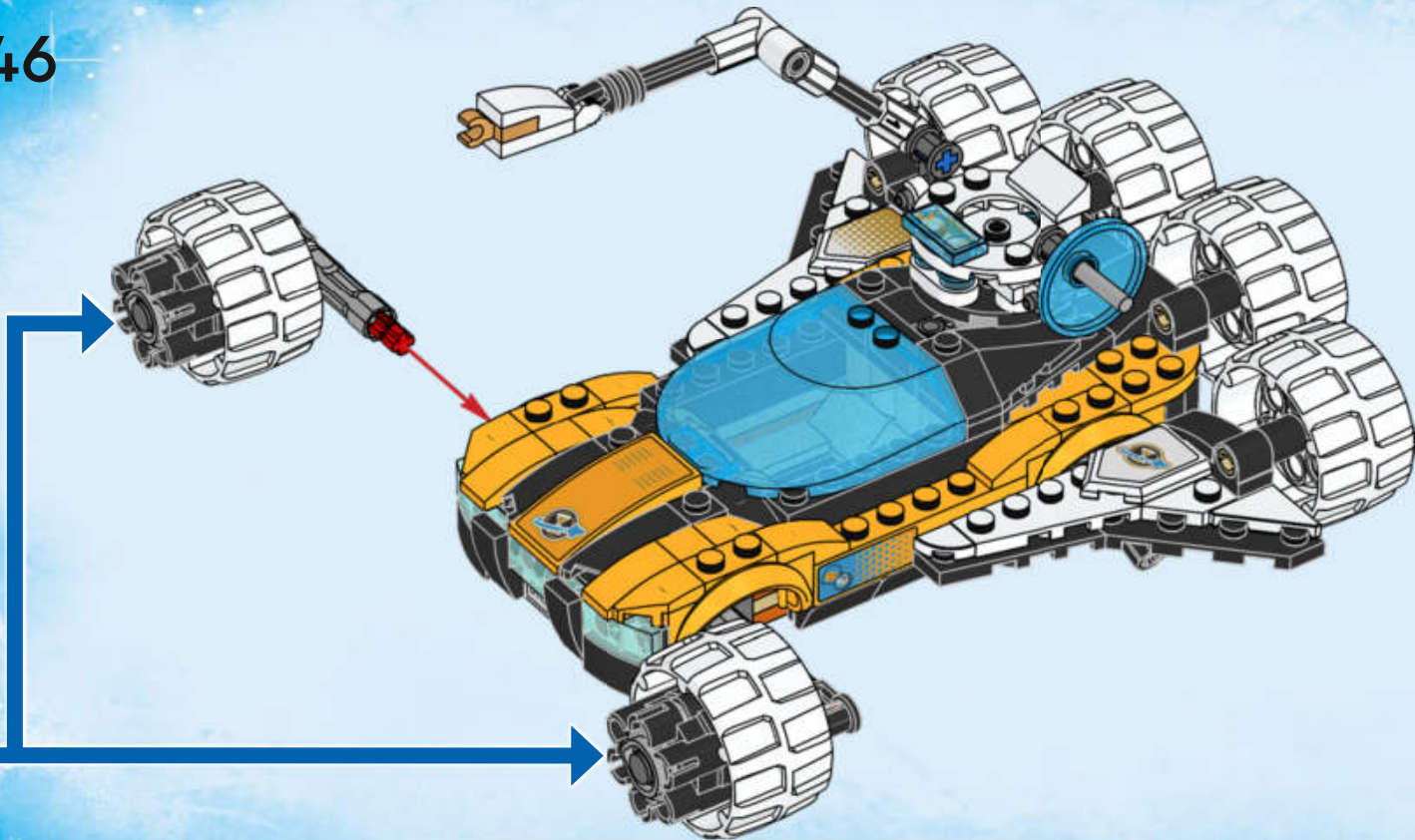

  
18x

47

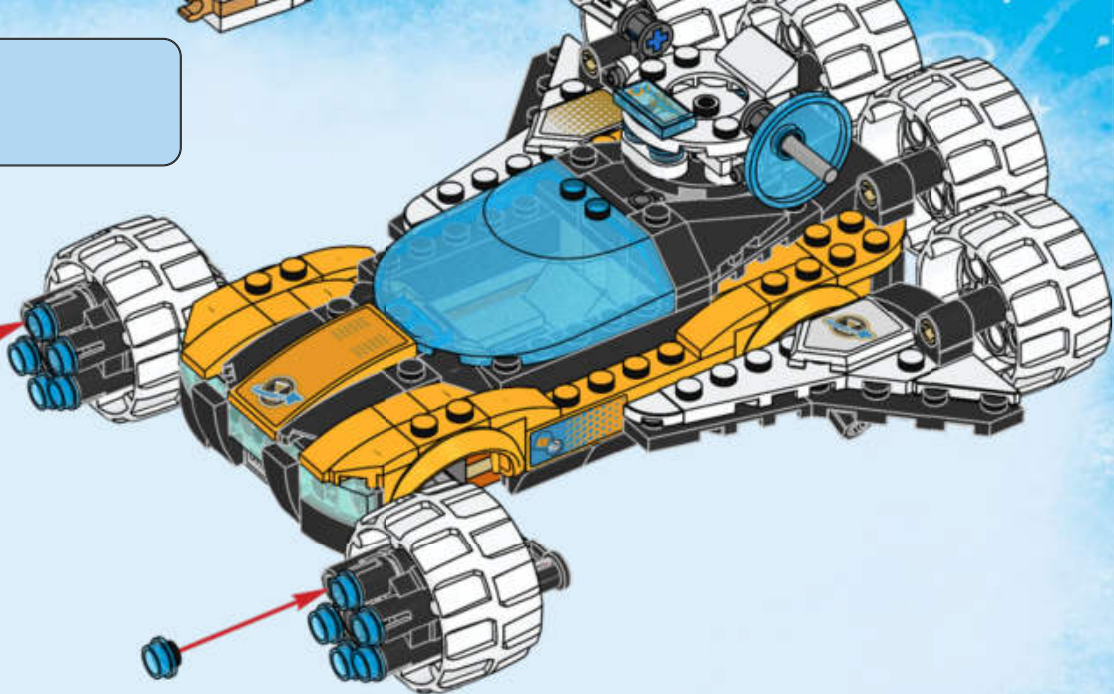

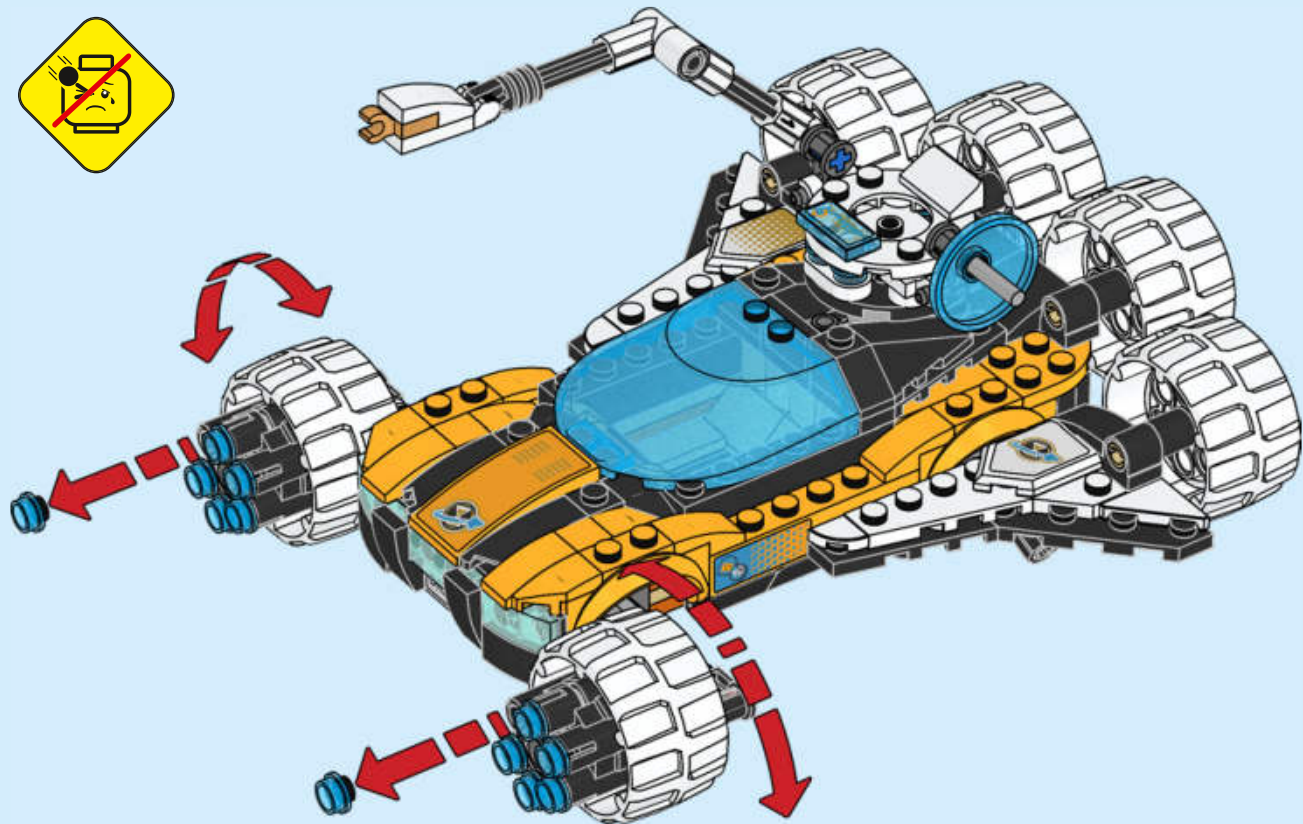





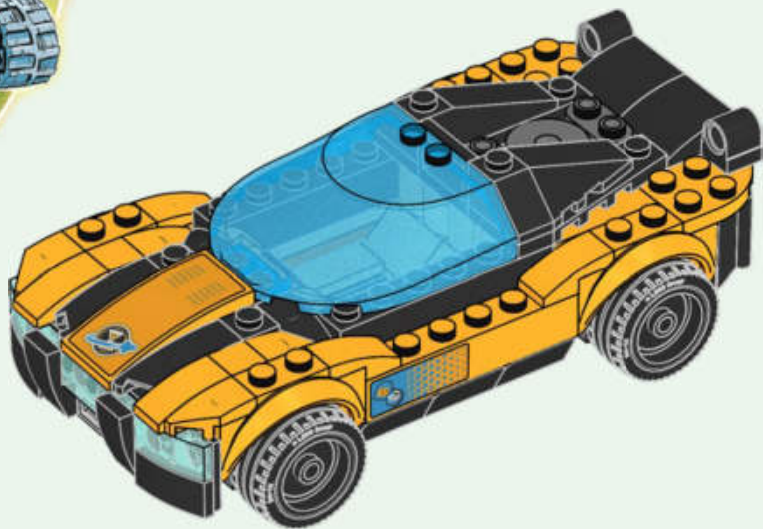

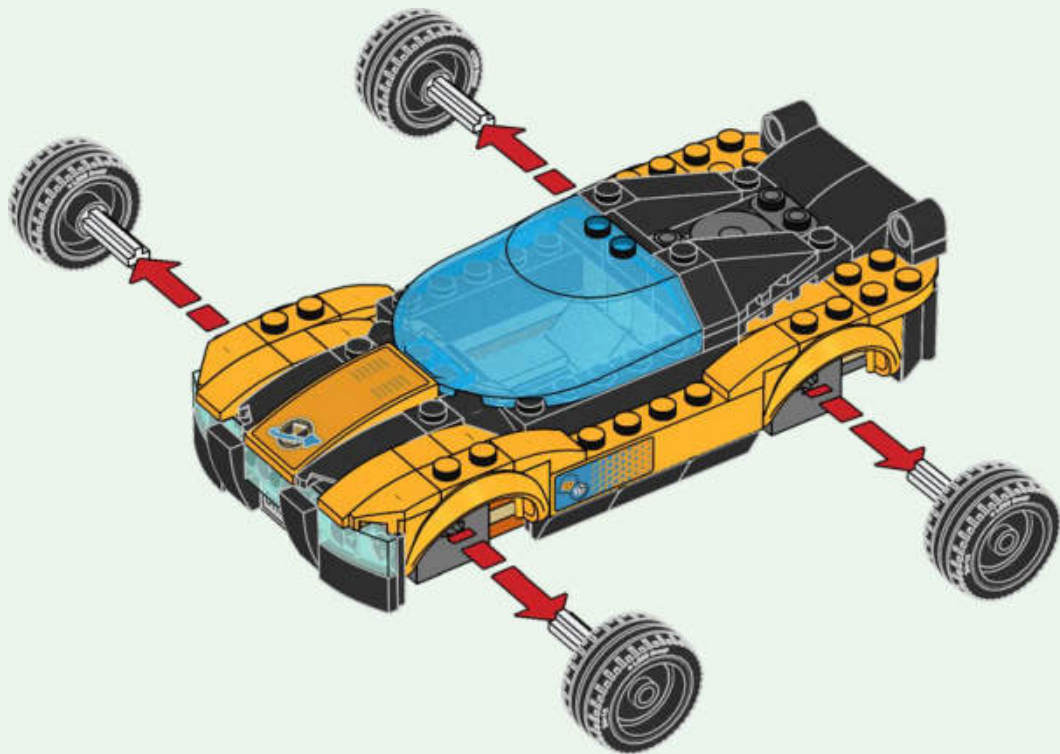

1



2





1

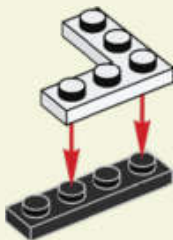

2





1x



1x

3



1x

4



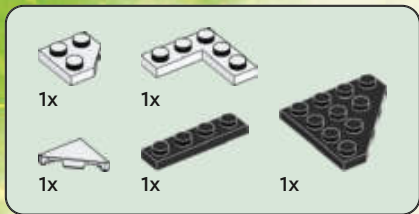

5

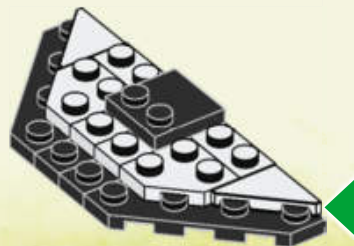
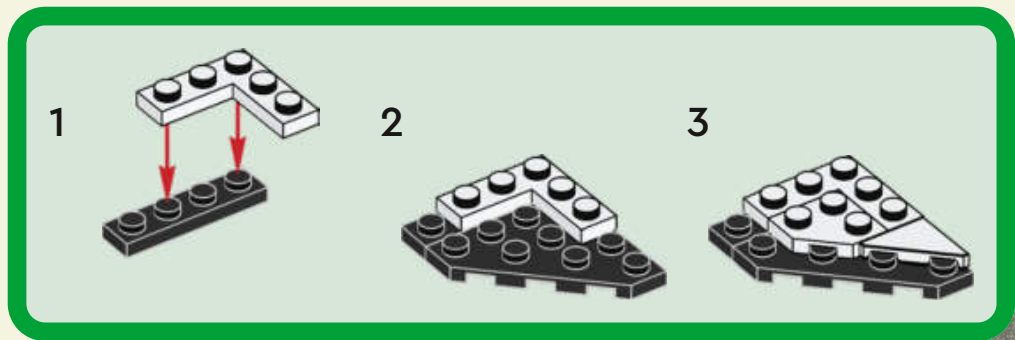



6

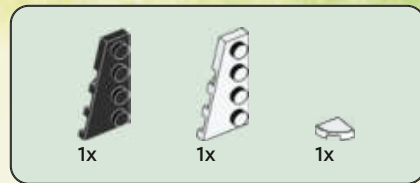
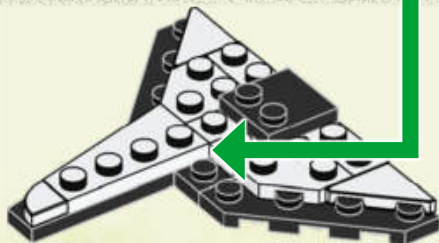
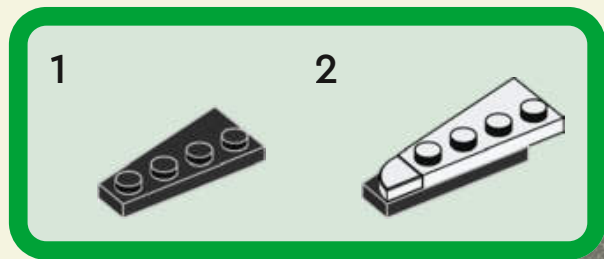

7

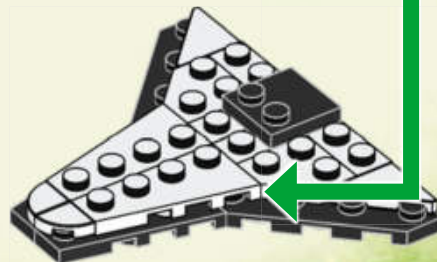
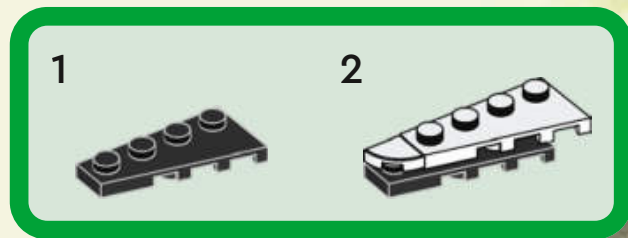



2x

8



2x



1x



1x

9

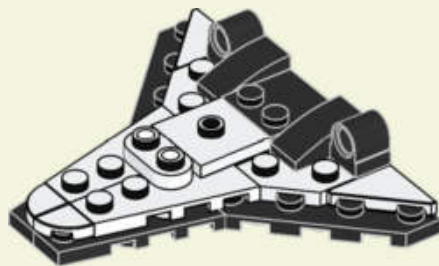





2x

10



11

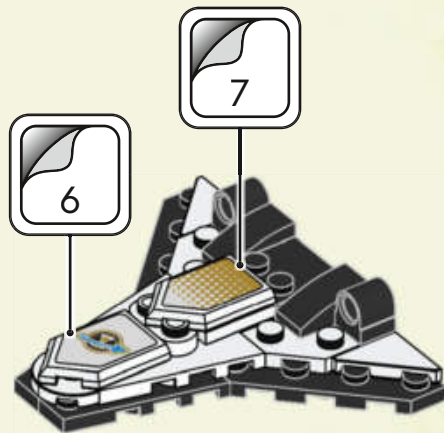



6x



3x

# 12

1



2



3x

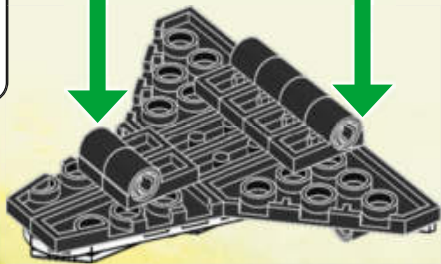

2x

# 13





2x



2x



4x



2x



4x



4x

14

1



2



3



4

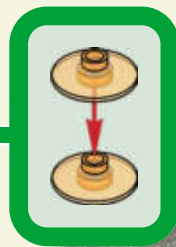

5

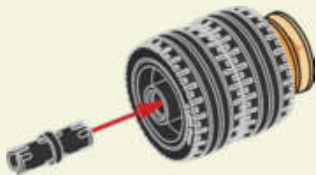

2x

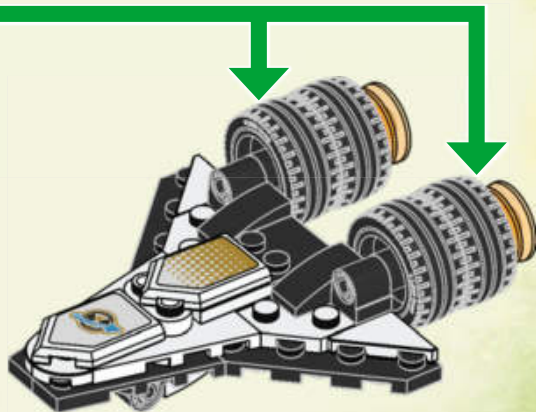

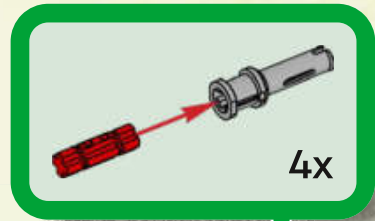
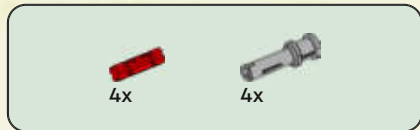

1

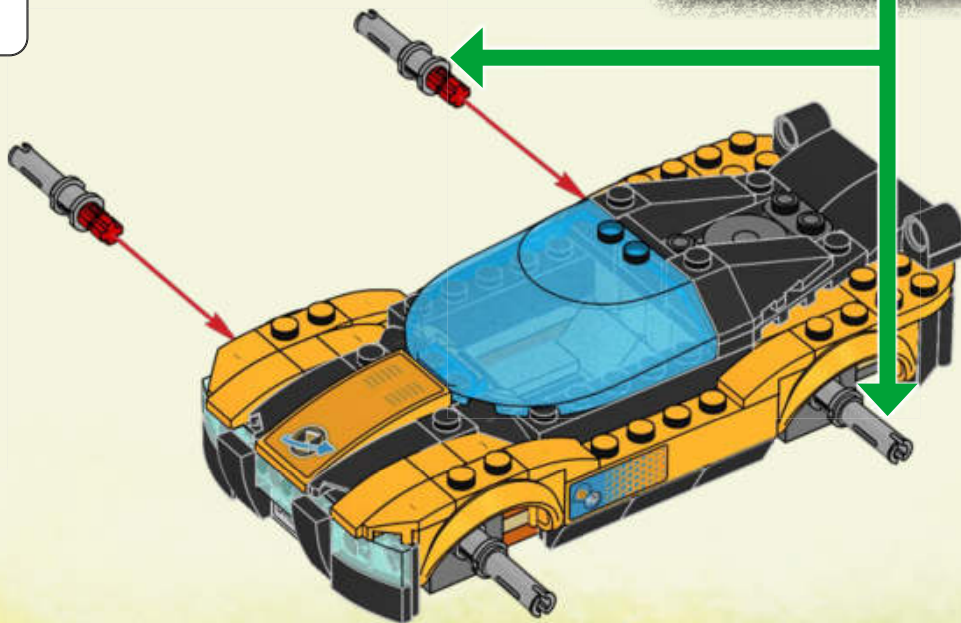

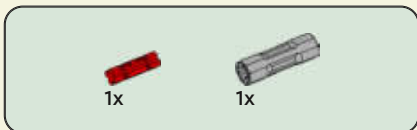

2

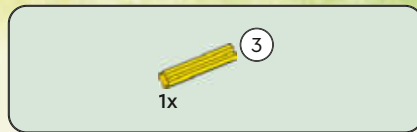
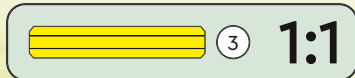
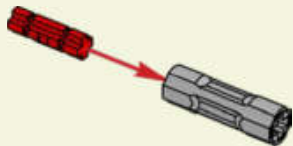

3



4



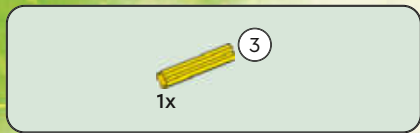

5

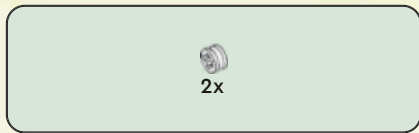
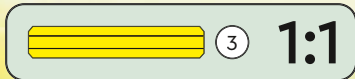
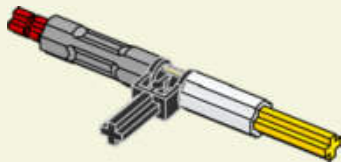

6

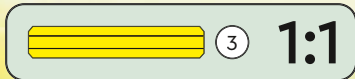
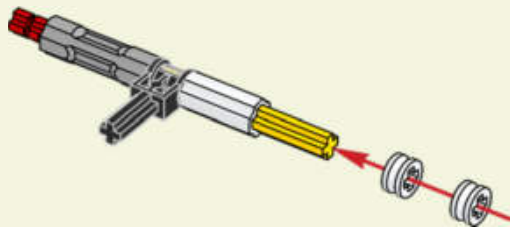





7

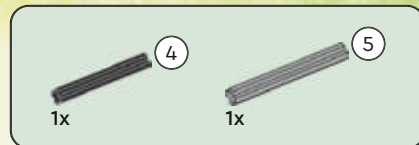
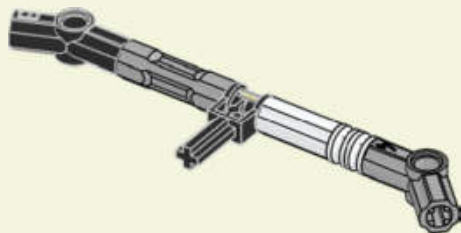

8

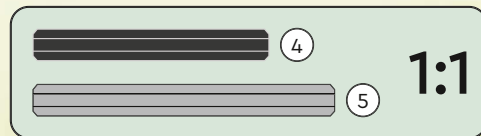
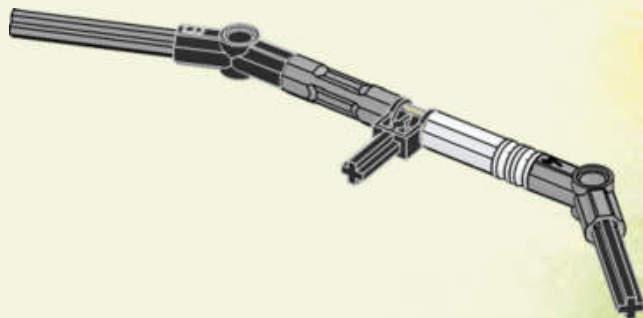



3x

9

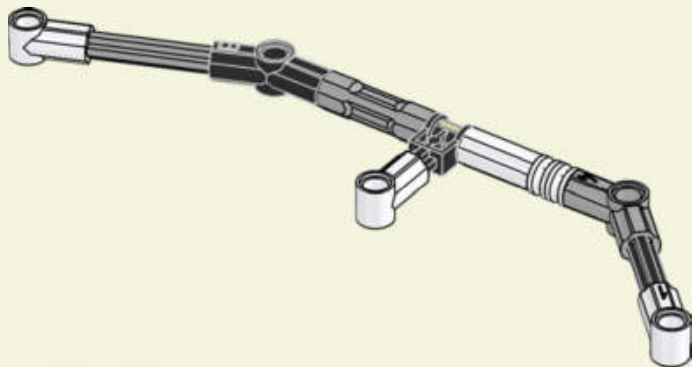

2x

10

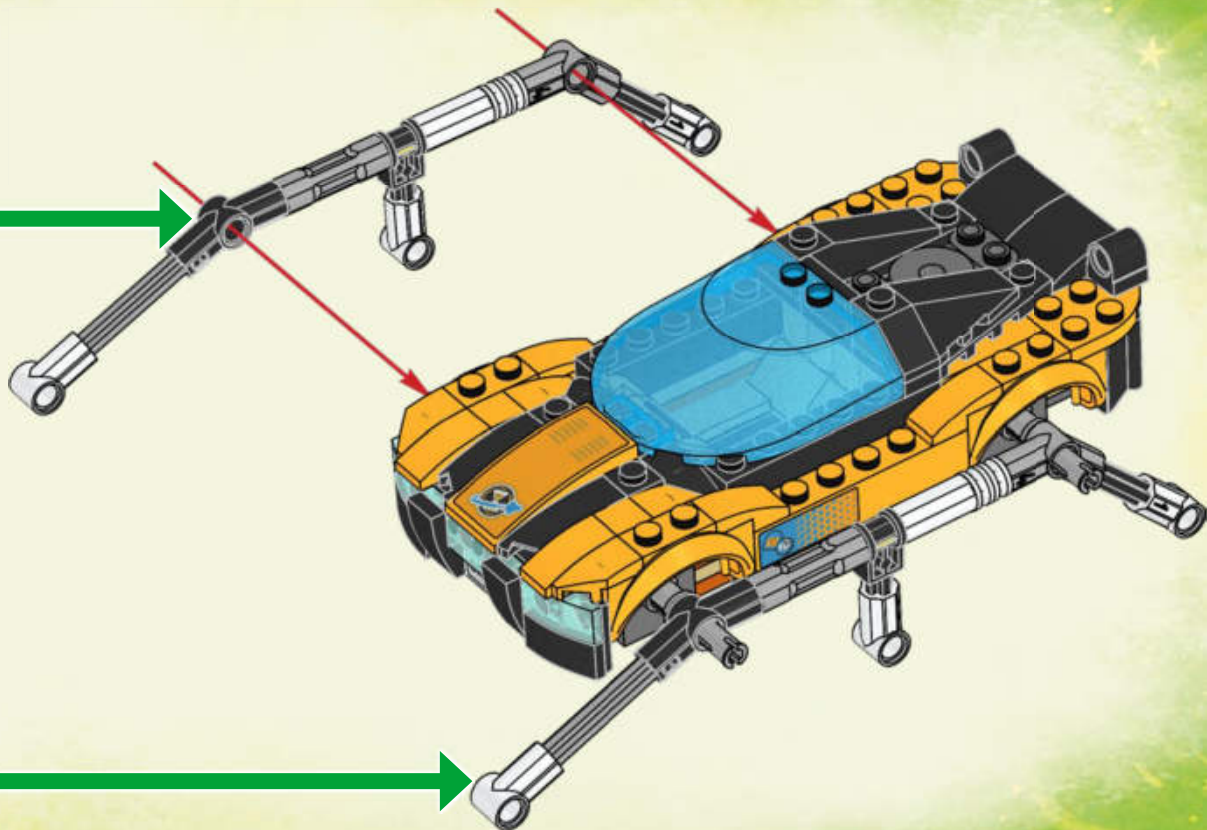



11

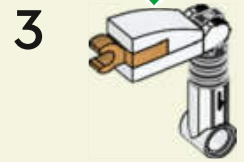
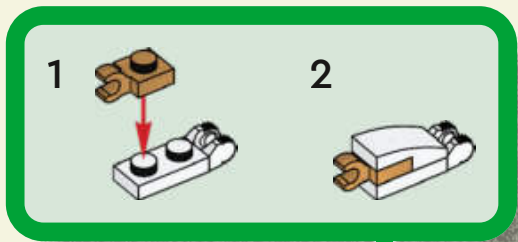
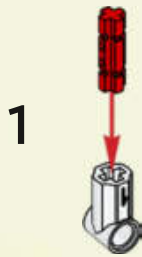

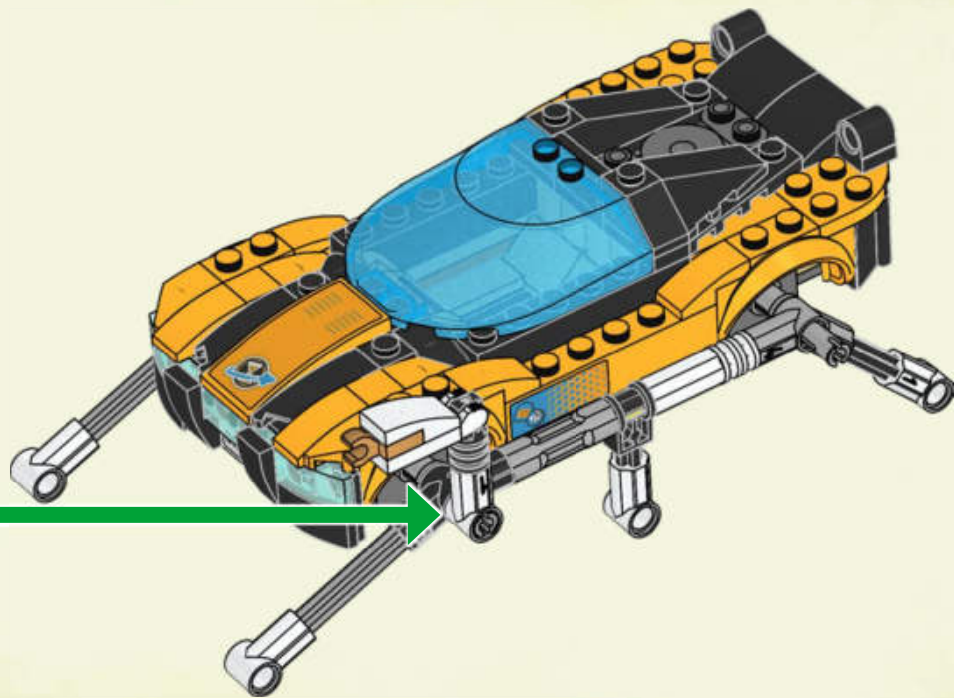



1x



1x



2x



1x

# 12

1



2



3



4



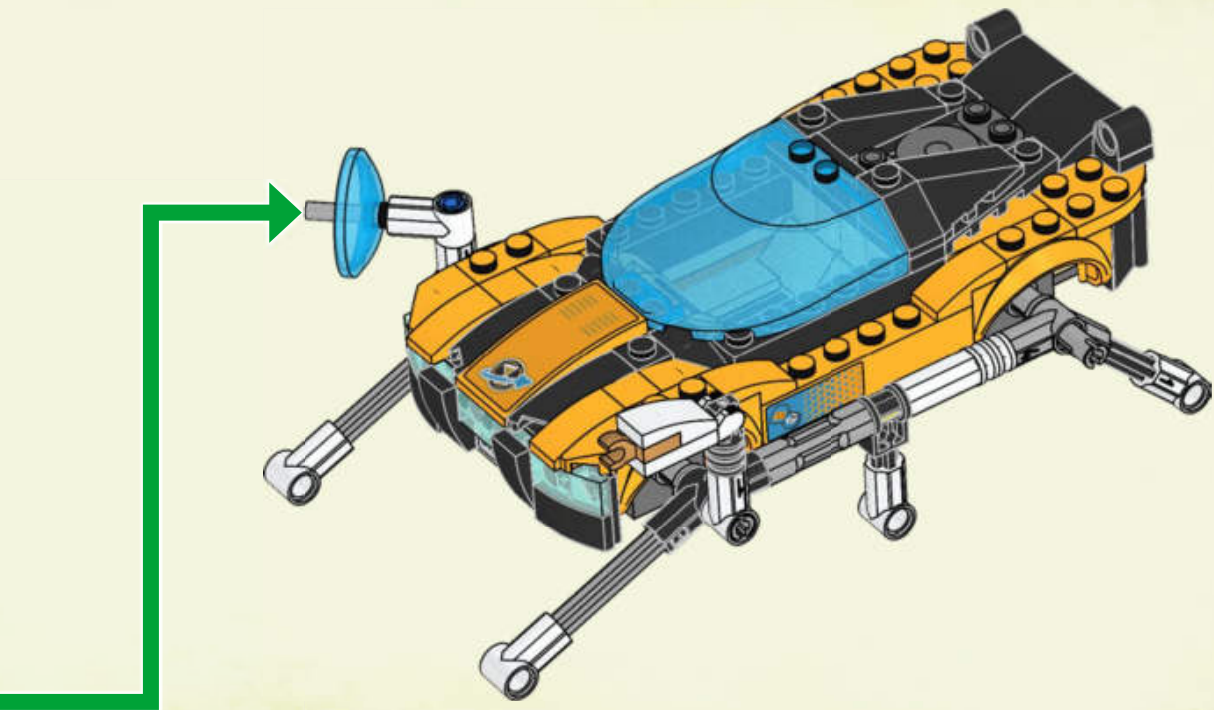



13

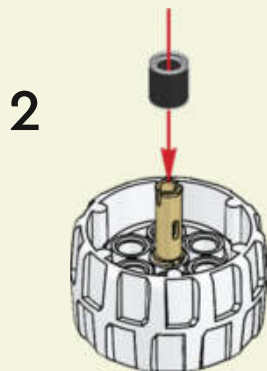
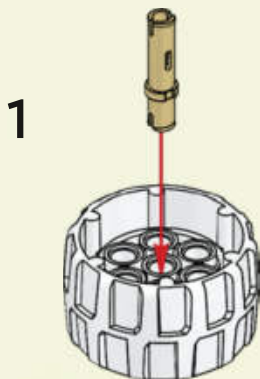

6x



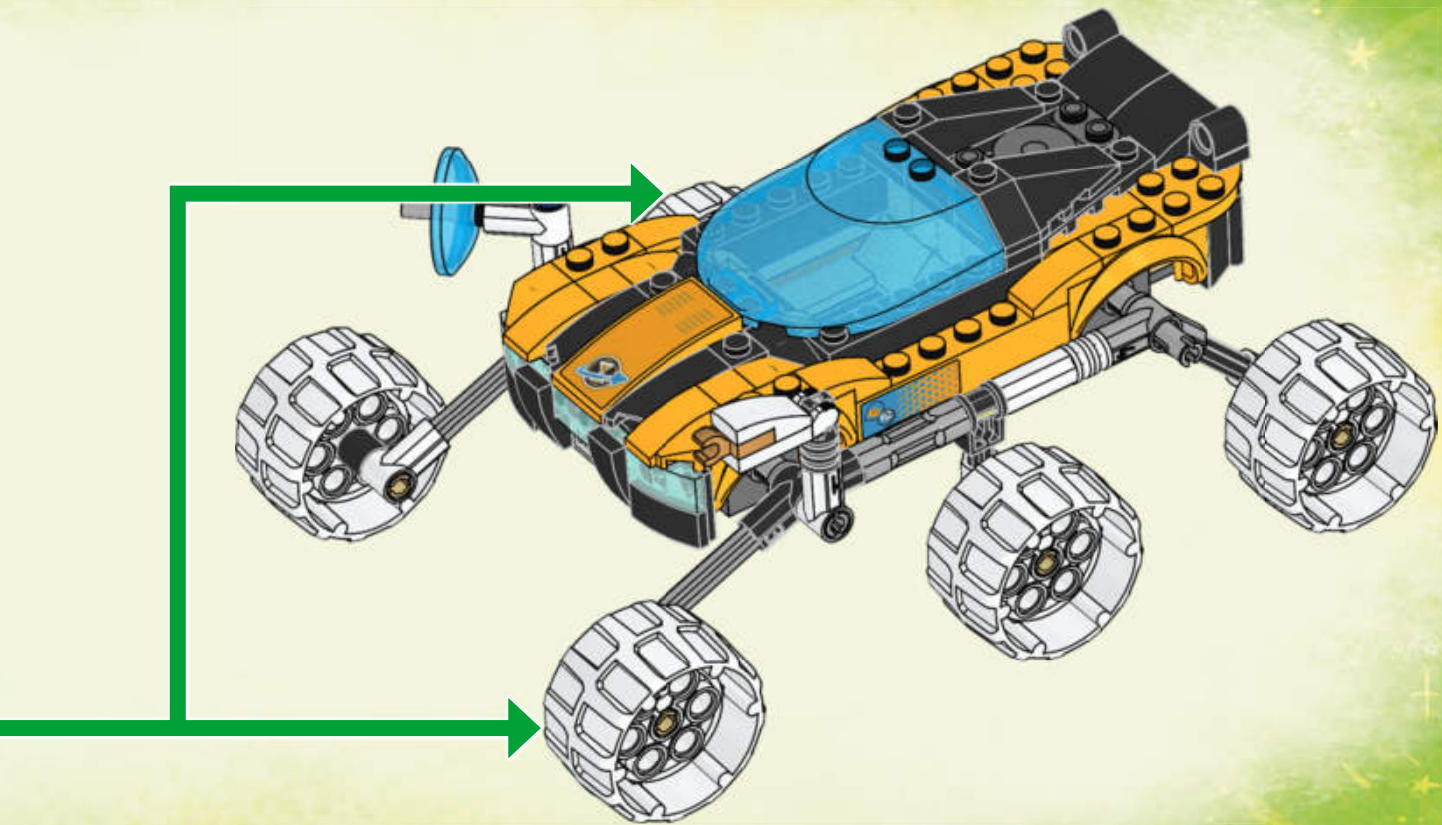

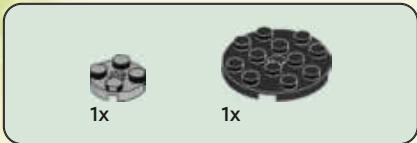

14





4x

15



1x



2x

16





4x

17

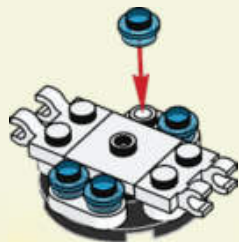

1x

18





1x



1x

19



20





1x

21

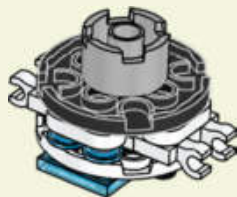



2x

22



1x

23

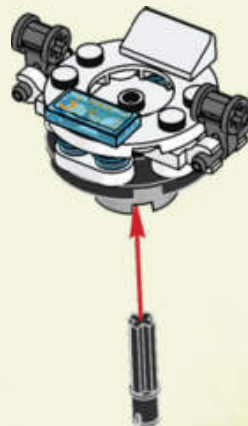



2x



4

1:1



1x



1x

24





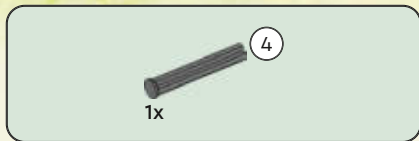

25



26





1x



1x

27

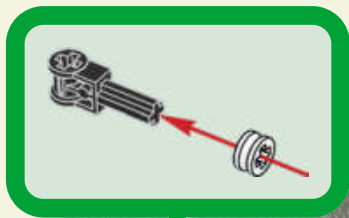

2x

28

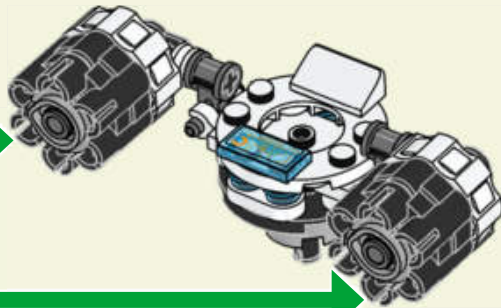

29

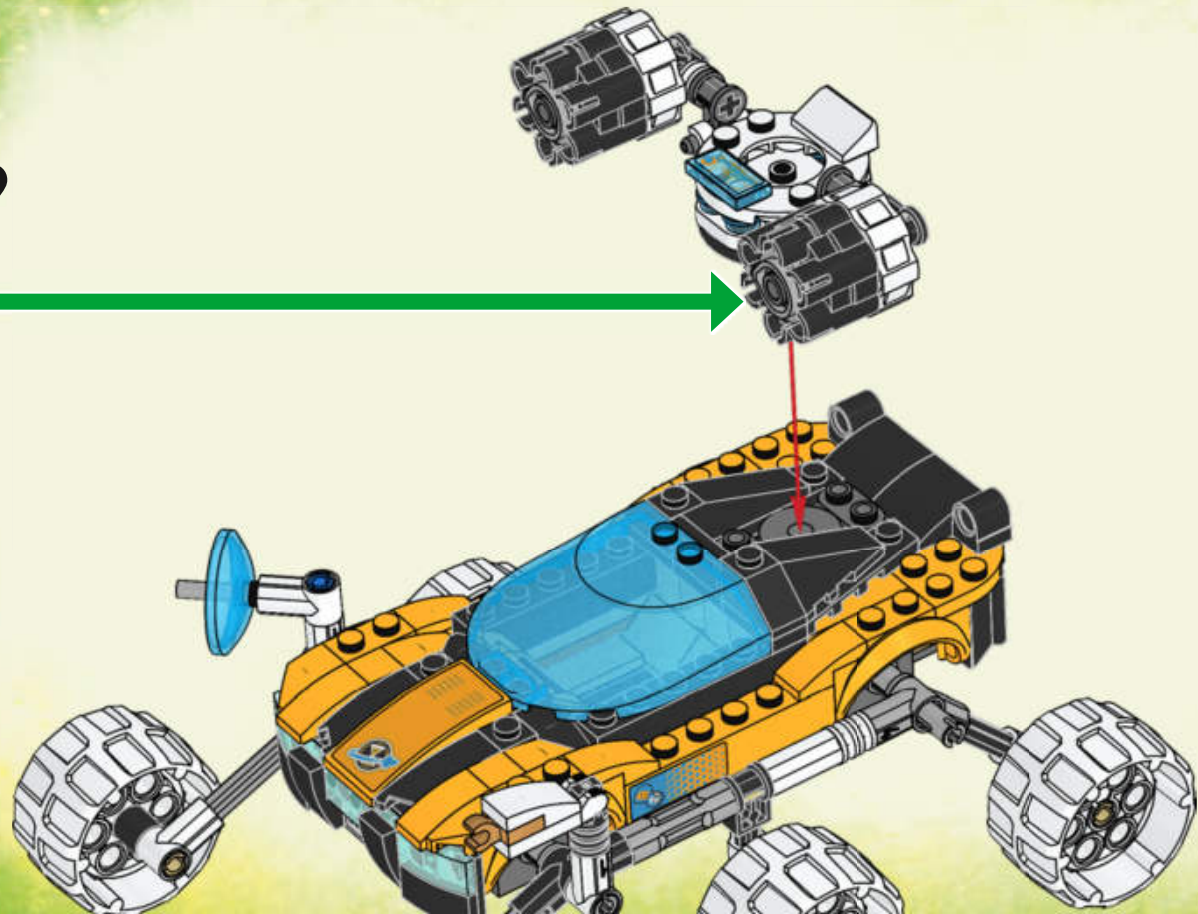

18x

30

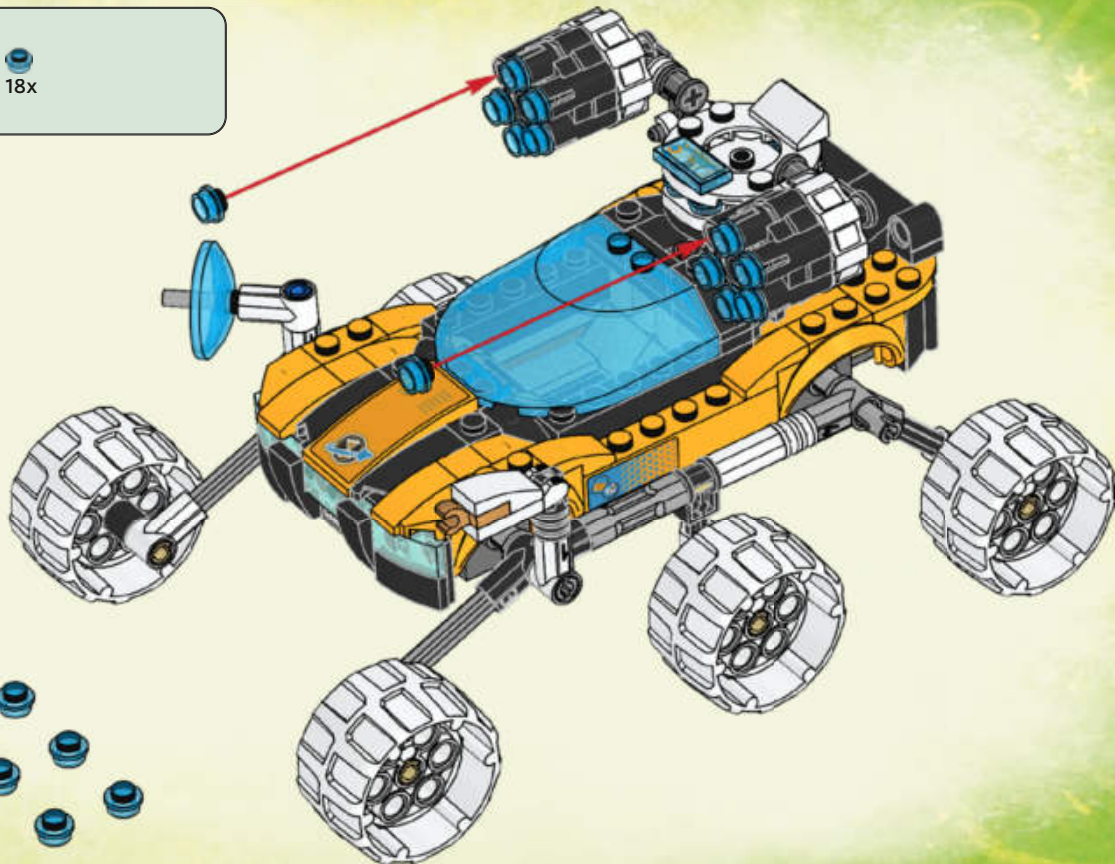

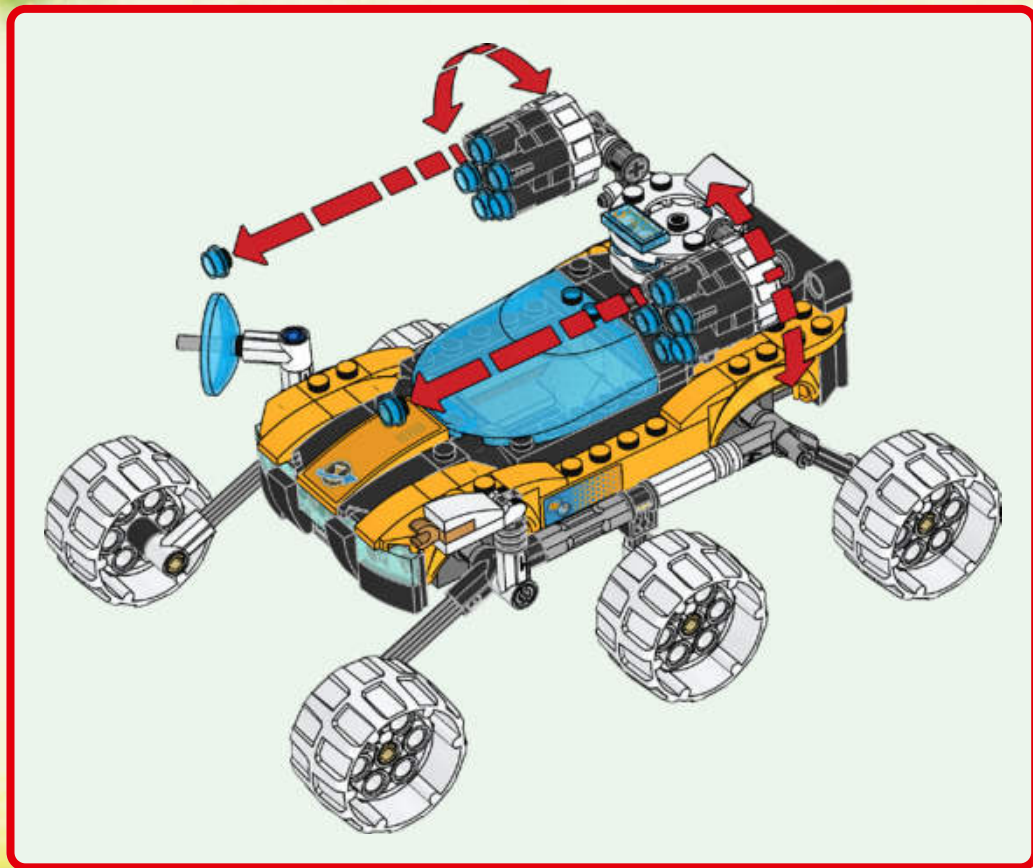



**LEGO**

# DREAMZZZ



**71471**



**71472**



**71475**



**71476**



**71477**



Watch series online  
Schau dir die Serie online an  
Regarde la série en ligne  
Guarda la serie online  
Mira la serie en Internet  
Assistir à série online  
在线观看  
Oglądaj serial w internecie  
Sleduj seriál online  
Pozri si seriál online  
Nézd a sorozatot online  
Vizionează serialul online  
Глядите сериала онлайн  
Skaties seriālu tiešsaistē  
Vaata sarja veebist  
Žiūrėk serialą internetu



**LEGO**



**DREAMZZZ**



**WATCH  
SERIES  
ONLINE**



**7** [LEGO.com/DREAMZZZ](https://LEGO.com/DREAMZZZ)





1x  
4515350



1x  
370926



1x  
6040297



1x  
6179660



2x  
300926



1x  
366626



1x  
6170384



1x  
6266626



1x  
6286876



1x  
6274739



2x  
6435020



1x  
6252049



22x  
6240214



1x  
6251289



2x  
6207783



4x  
6245310



2x  
6466832



2x  
6289747



2x  
6289745



6x  
6099728



2x  
6003033



2x  
6099725



2x  
6099725



2x  
6022078



1x  
6421207



4x  
6421680



2x  
6065504



2x  
6186542



4x  
4211525



1x  
6430880



1x  
4211475



1x  
4211526



2x  
6361703



1x  
6093527



2x  
6262905



2x  
64211353



4x  
6321747



2x  
6273212



2x  
4211639



1x  
6469669



2x  
4211098



2x  
6265669



6x  
6221607



4x  
6350724



1x  
6055313



2x  
4211095



2x  
6083620



2x  
6454959



1x  
4586410



1x  
6284379



1x  
6473075



1x  
6473071



1x  
6473071



1x  
6469665



1x  
6469666



4



1x  
6469667



1x  
6469668



1x  
6046398



1x  
6197967



3x  
6070757



1x  
6443370



1x  
6337410



1x  
6471291



4x  
6467485

[LEGO.com/service](https://www.LEGO.com/service)



**YOU COULD**  
**WIN**



Scan this QR code or go to  
**LEGO.COM/PRODUCTFEEDBACK** and give  
us your short feedback about this LEGO® set  
for a chance to win a cool LEGO prize.

Terms and Conditions apply\*

**EN: YOU COULD WIN.** Terms and Conditions apply\* **DE: Du könntest GEWINNEN.** Es gelten die Teilnahmebedingungen\* **FR: Tu pourrais GAGNER.** Des conditions s'appliquent\* **IT: Potresti VINCERE tu.** Termini e condizioni sono applicabili\* **ES: Puedes GANAR.** Aplican términos y condiciones\* **PT: Poderá GANHAR.** Aplicam-se termos e condições\* **ZH: 轻松获奖. 条款和条件适用\*** **PL: Szansa na WYGRANĄ.** Obowiązują warunki korzystania\* **CS: Máte šanci VYHRÁT.** Platí všeobecné smluvní podmínky\* **SK: Máte šancu VYHRAŤ.** Platia všeobecné zmluvné podmienky\* **HU: TE IS NYERHETSZ.** Felhasználási feltételek érvényesek\* **RO: Ai putea CÂȘTIGA.** Se aplică termeni și condiții\* **BG: Можете да СПЕЧЕЛИТЕ.** Има определени правила и условия\* **LV: Tu vari LAIMĒT.** Ir spēkā noteikumi un nosacījumi.\* **ET: Sul on võimalus VÕITA.** Kehtivad tingimused\* **LT: Jūs galite LAIMĖTI.** Taikomos sąlygos\*

\*[LEGO.com/productfeedback/terms](https://www.lego.com/productfeedback/terms)

LEGO, the LEGO logo and DREAMZzz are trademarks of the LEGO Group. ©2024 The LEGO Group.

6494355