



MINECRAFT

21254



Q LEGO® Builder



LEGO.com/sustainable-packaging



FR
DONNEZ
OU
RECYCLEZ



OU



OU



ASSOCIATION

MAGASIN

DÉCHÈTERIE

Adresses sur quefairedemesdechets.fr

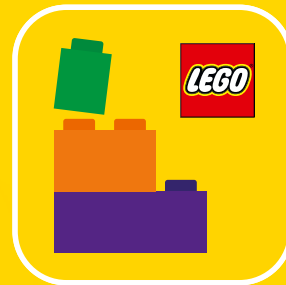

BUILDER



Apple and the Apple logo are trademarks of Apple Inc., registered in the U.S. and other countries and regions. App Store is a service mark of Apple Inc. Google Play and the Google Play logo are trademarks of Google LLC. Tencent and the Tencent logo are trademarks of Tencent Inc.

[LEGO.com/devicecheck](https://www.lego.com/devicecheck)

EN Ask parents' permission before going online | **DE** Eltern um Erlaubnis bitten, bevor du online gehst | **FR** Demande l'autorisation d'un parent avant d'aller en ligne | **IT** Chiedi il permesso ai tuoi genitori prima di andare online | **ES** Pídeles permiso a tus papás antes de conectarte a Internet | **PT** Pede autorização aos pais antes de acederes online | **ZH** 上网前应先征得父母的同意 | **PL** Poproś rodziców o zgodę, zanim wejdiesz do Internetu | **CS** Než půjdeš na internet, požádej rodiče o svolení | **SK** Skôr než pôjdeš na internet, vypýtaj si povolenie od rodičov | **HU** Kérj szülői engedélyt, mielőtt online csatlakoznál! | **RO** Cere permisiunea părinților înainte de a te conecta online | **BG** Поискайте разрешение от родител, преди да влезете онлайн | **LV** Pirms došanās tiešsaistē palūdz atļauju vecākiem | **ET** Enne Interneti kasutamist küsi vanematelt luba | **LT** Prieš prisijungdami prie interneto, atsklauskite tėvų

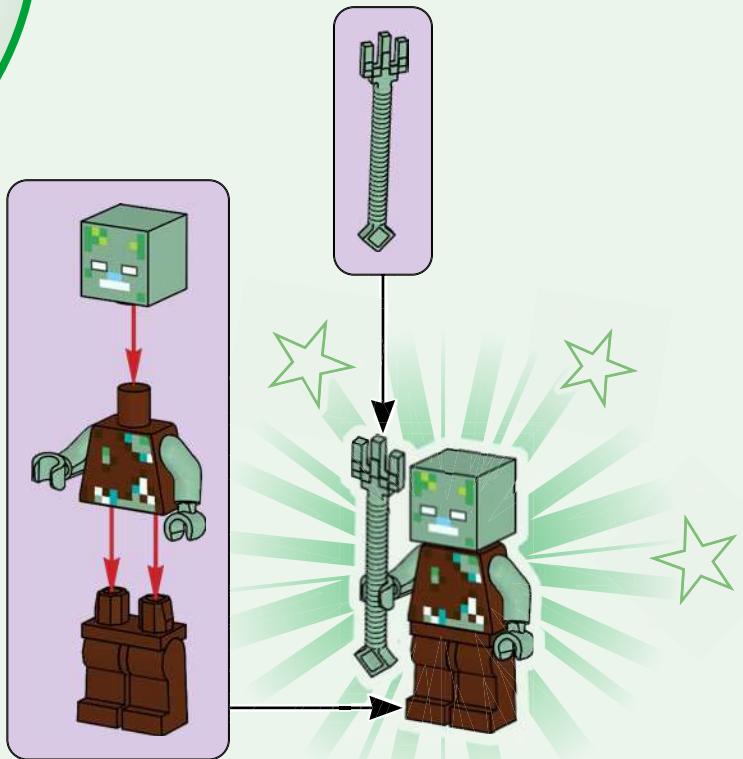

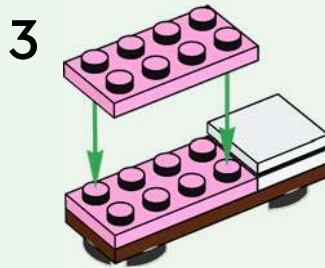
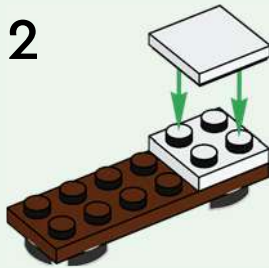
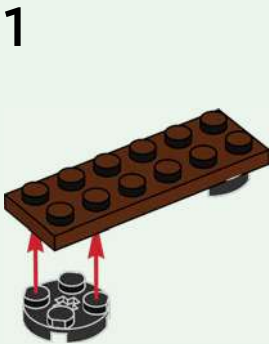
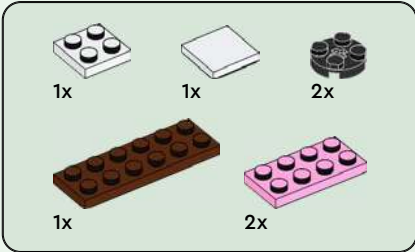

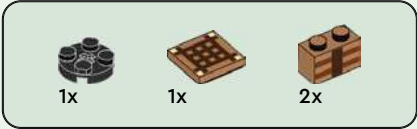

1



2

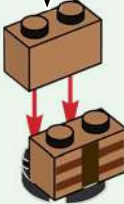
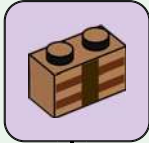

3



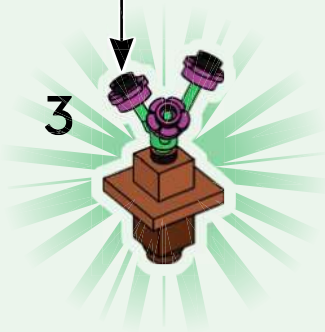
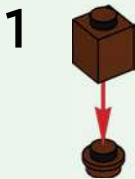
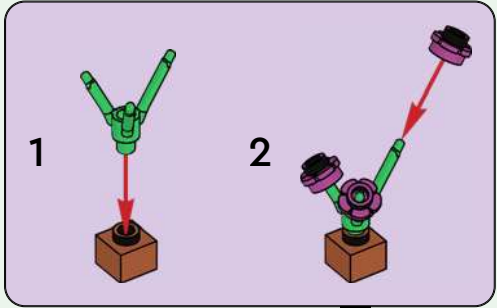
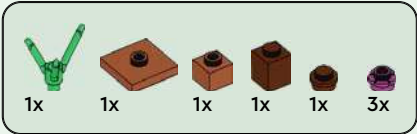

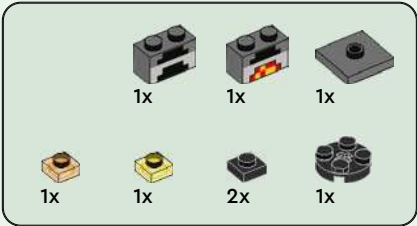

1



2

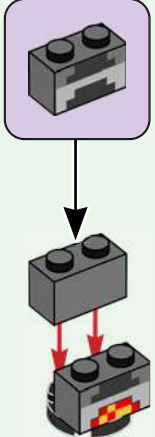

3



4

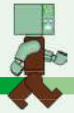
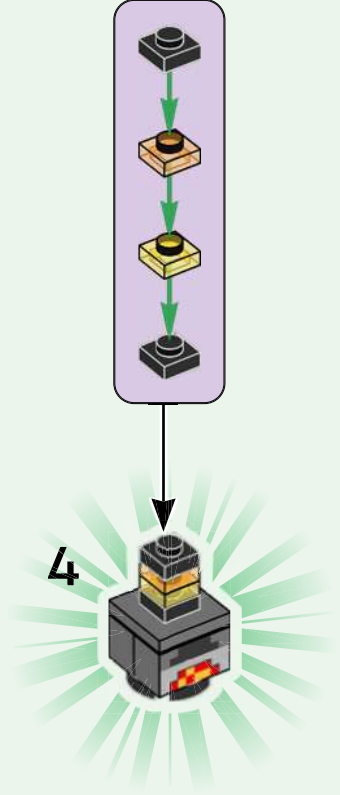

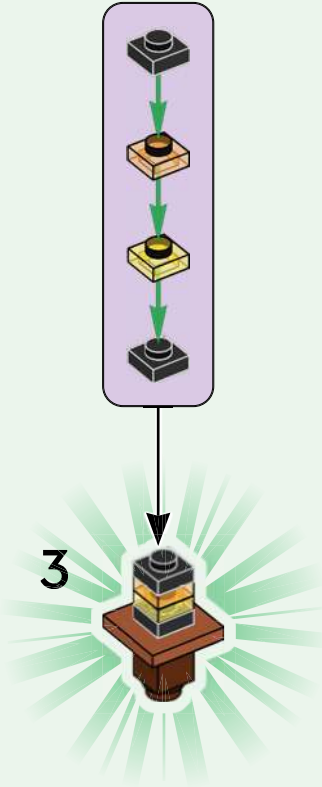
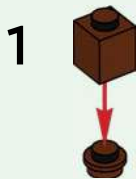

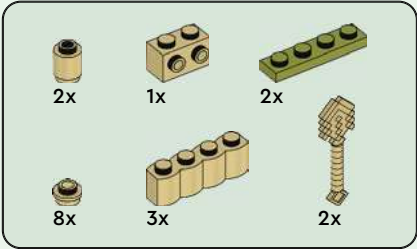

1

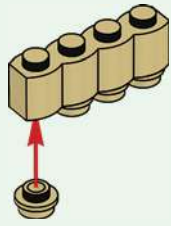

2

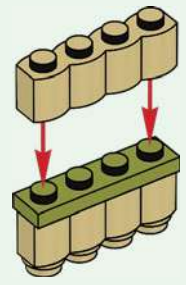

3

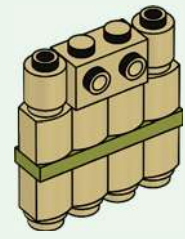

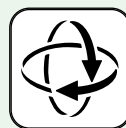
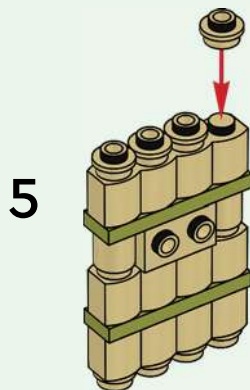
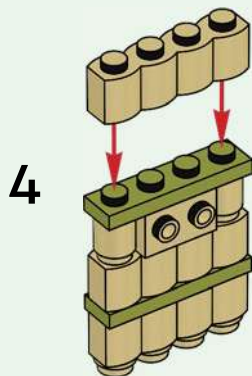

6



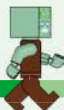
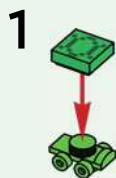

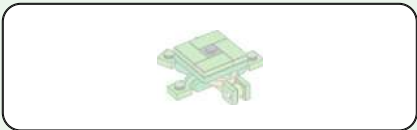

1



2

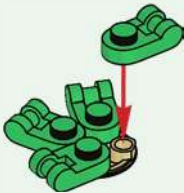

3

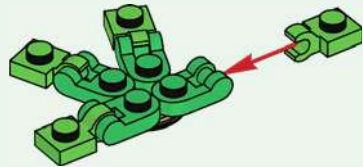

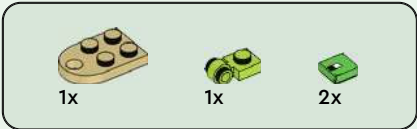

4

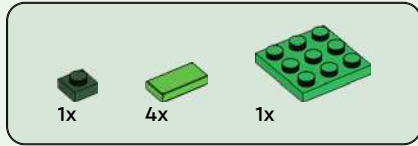
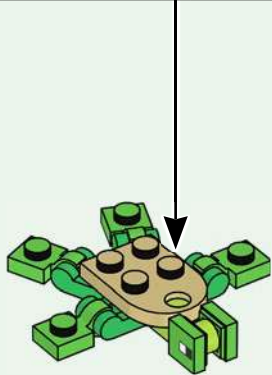
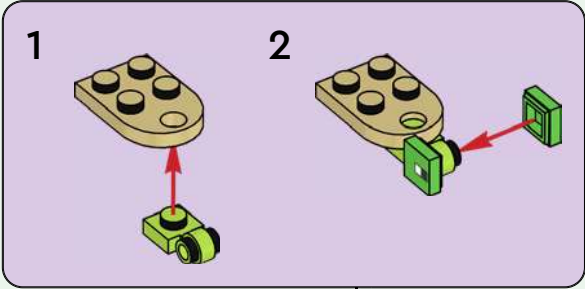

5

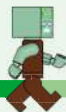
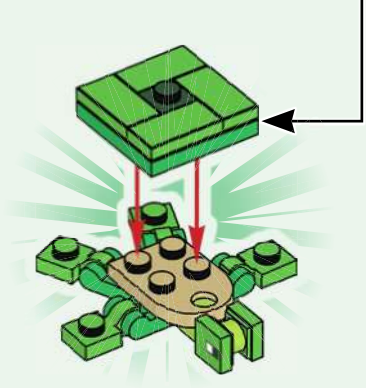
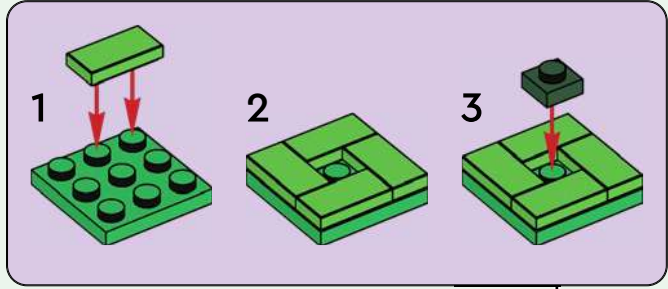

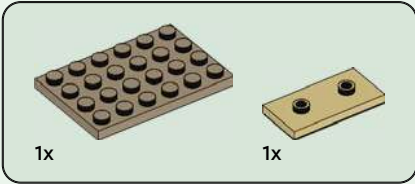
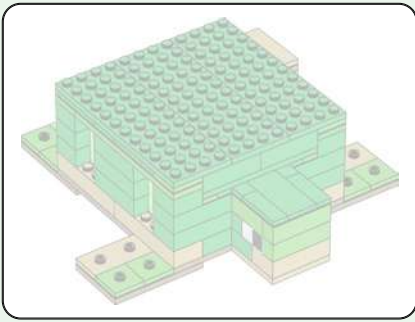

1

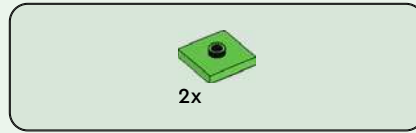
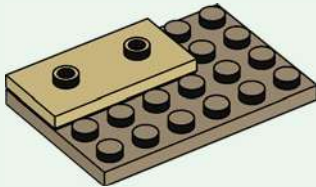

2

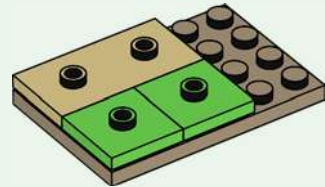

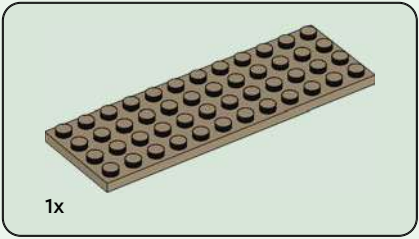

3

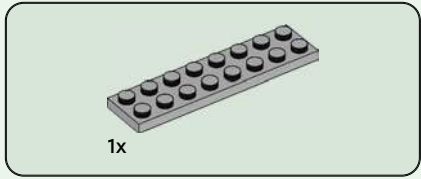
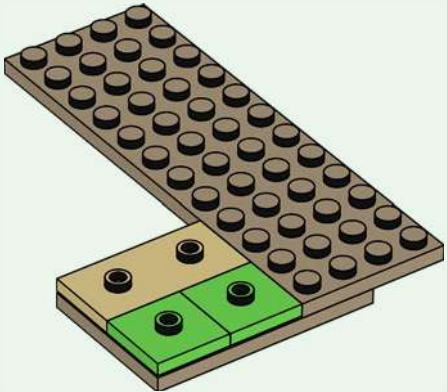

4

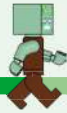
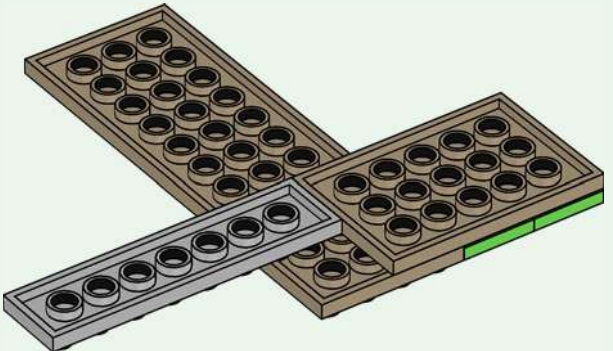

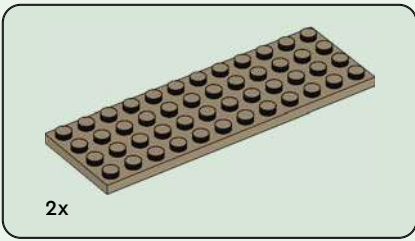

5

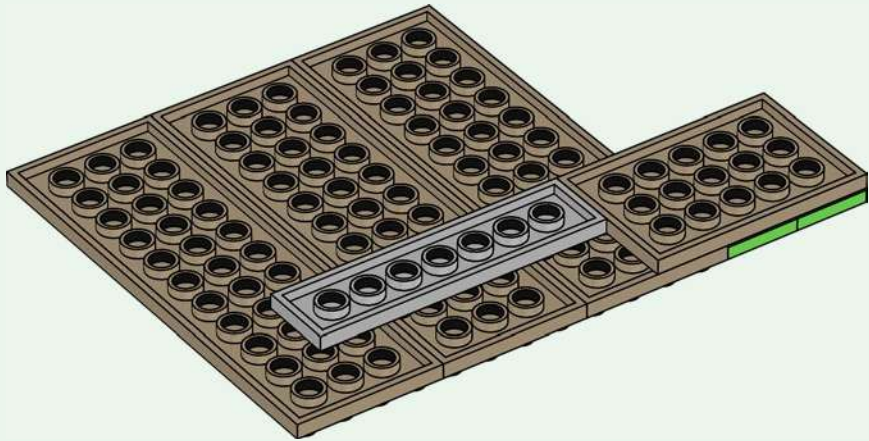

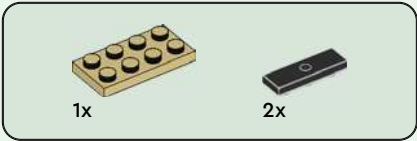

6

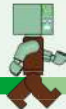
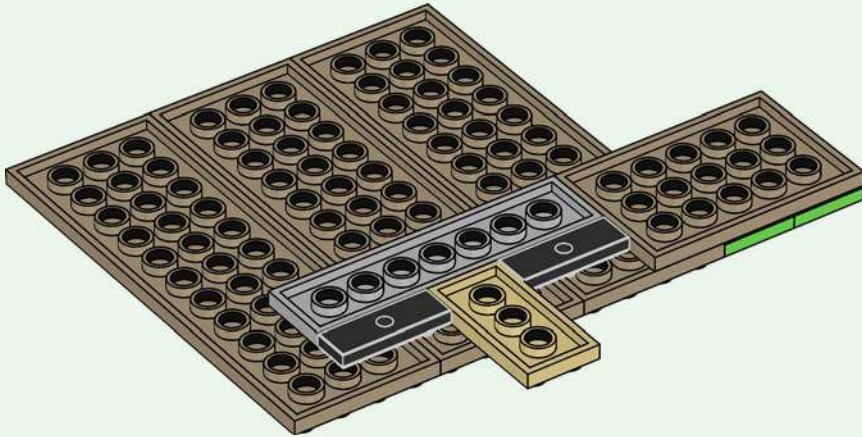

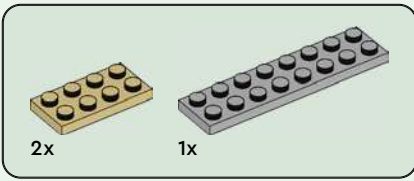

7

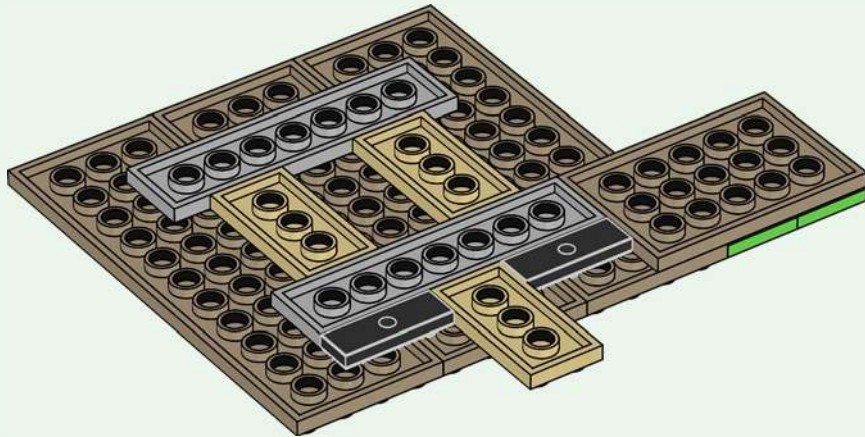

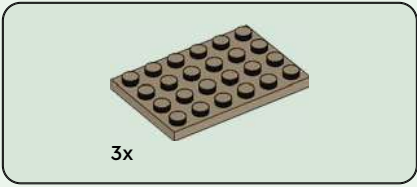

8

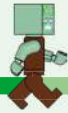
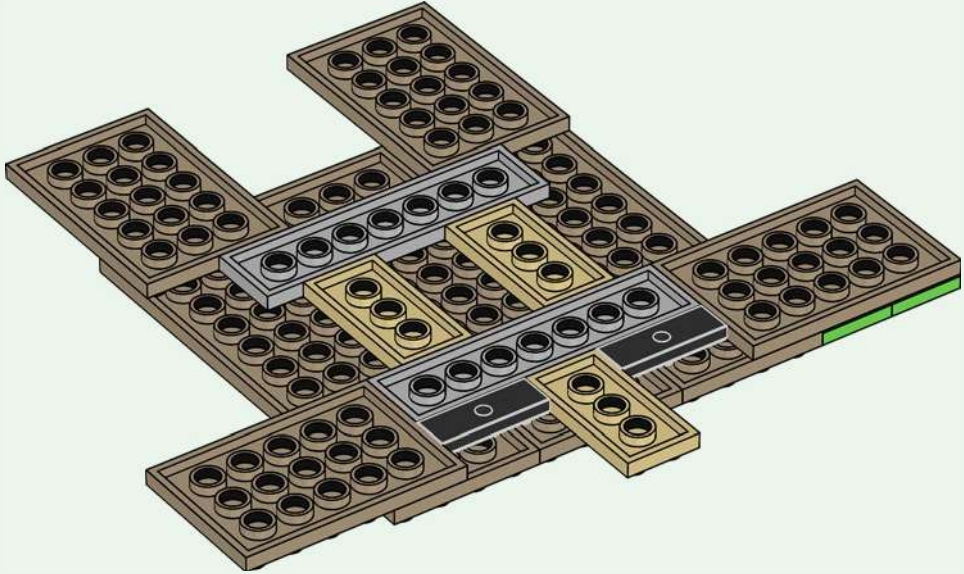

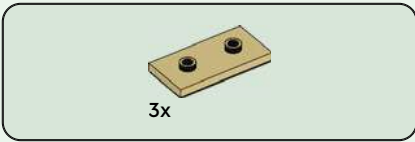

9

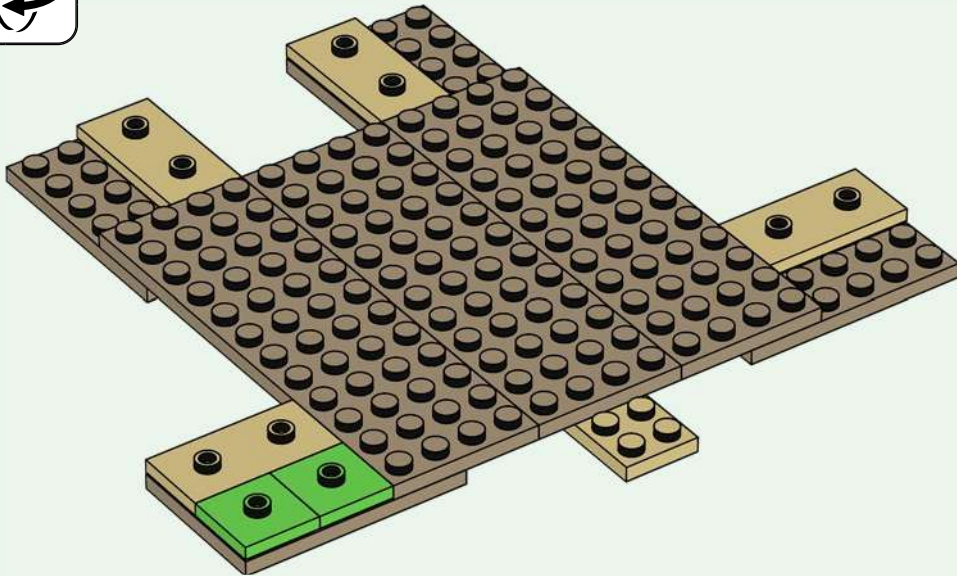



6x

10

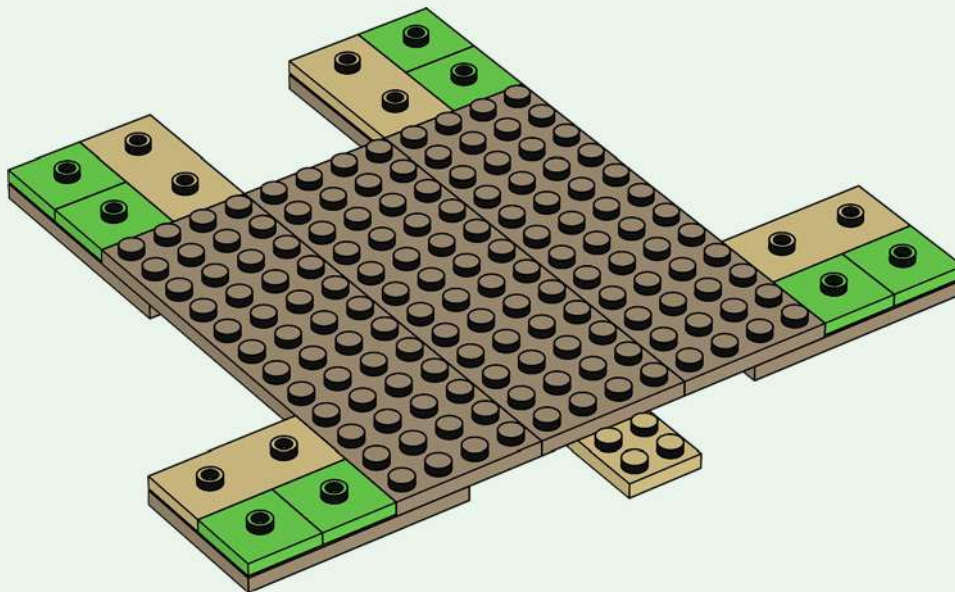

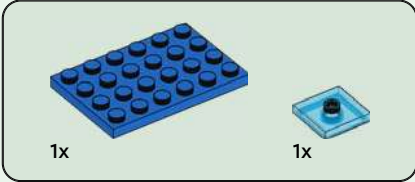
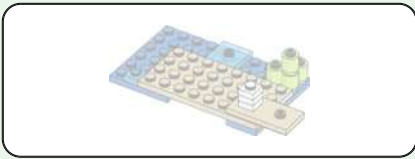

11

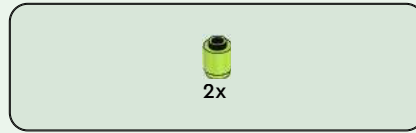
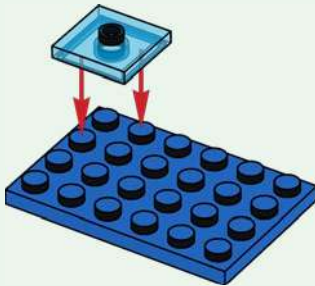

12





13

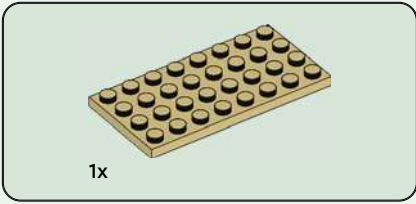
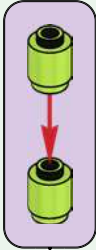

14

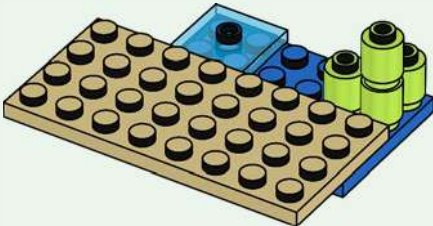

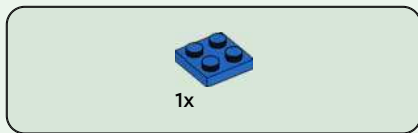

15

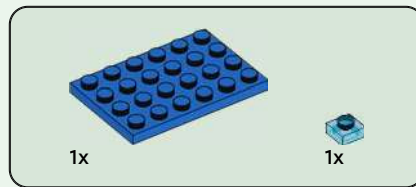
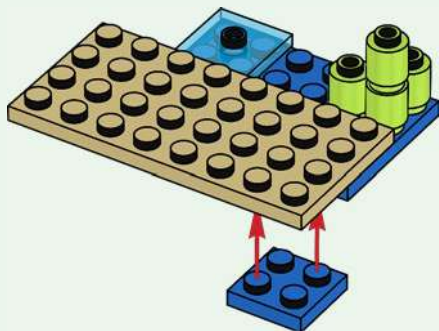

16

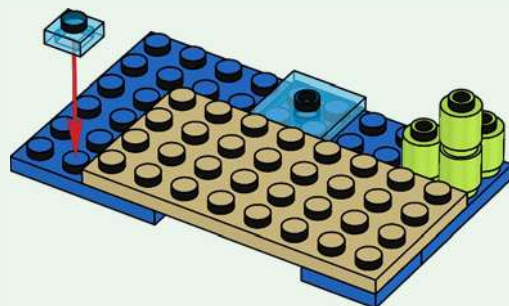

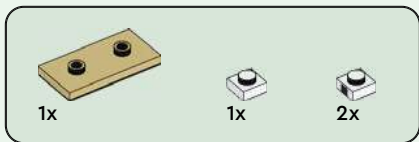

17

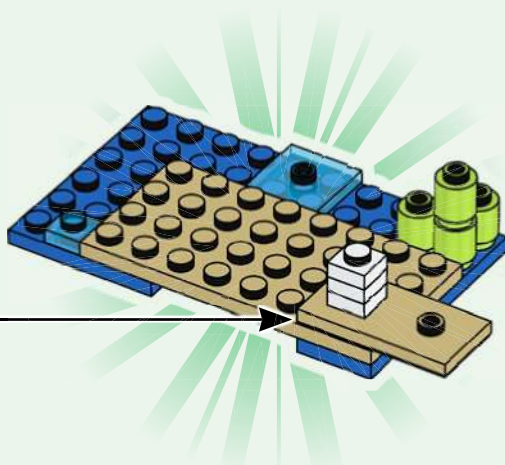
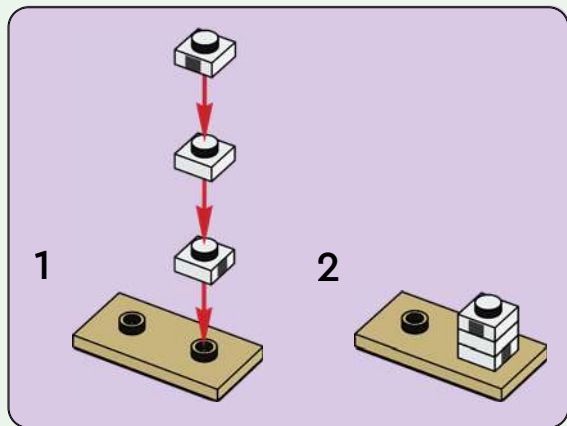

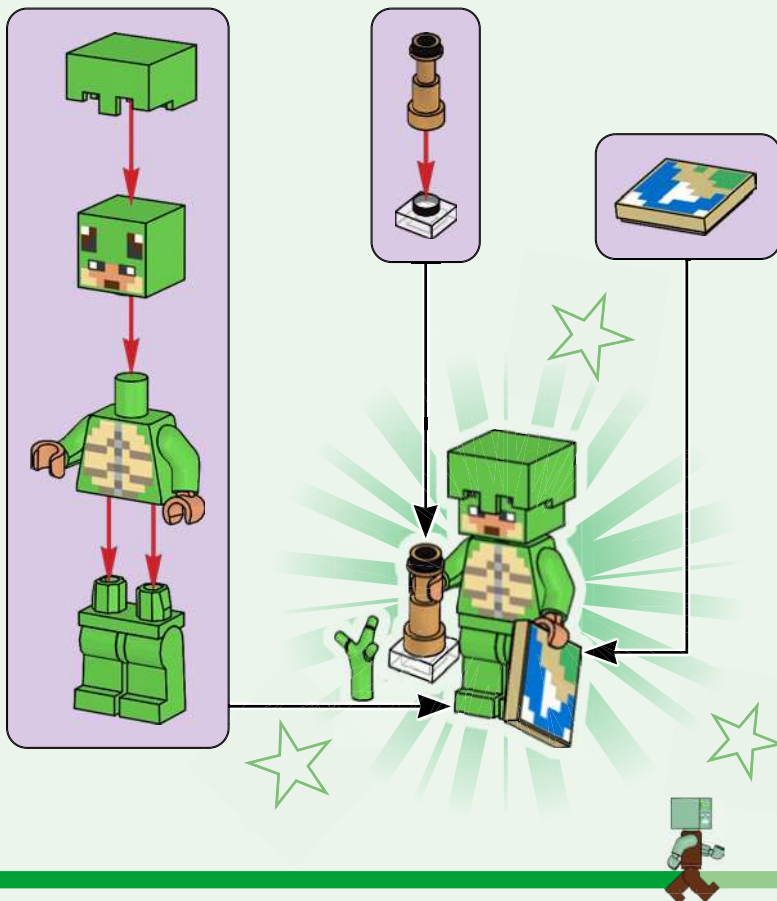
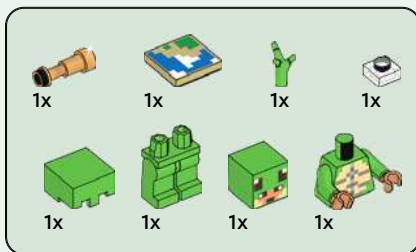

20

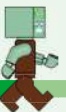
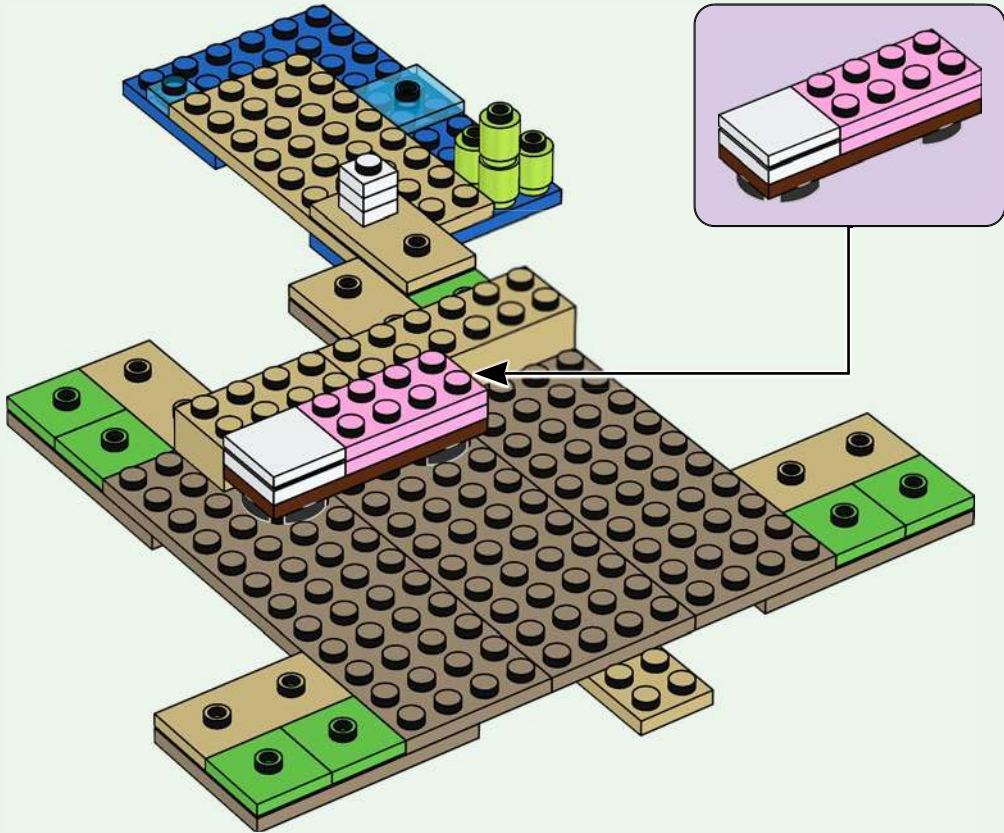

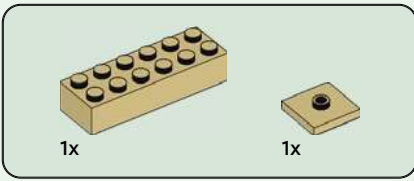

21

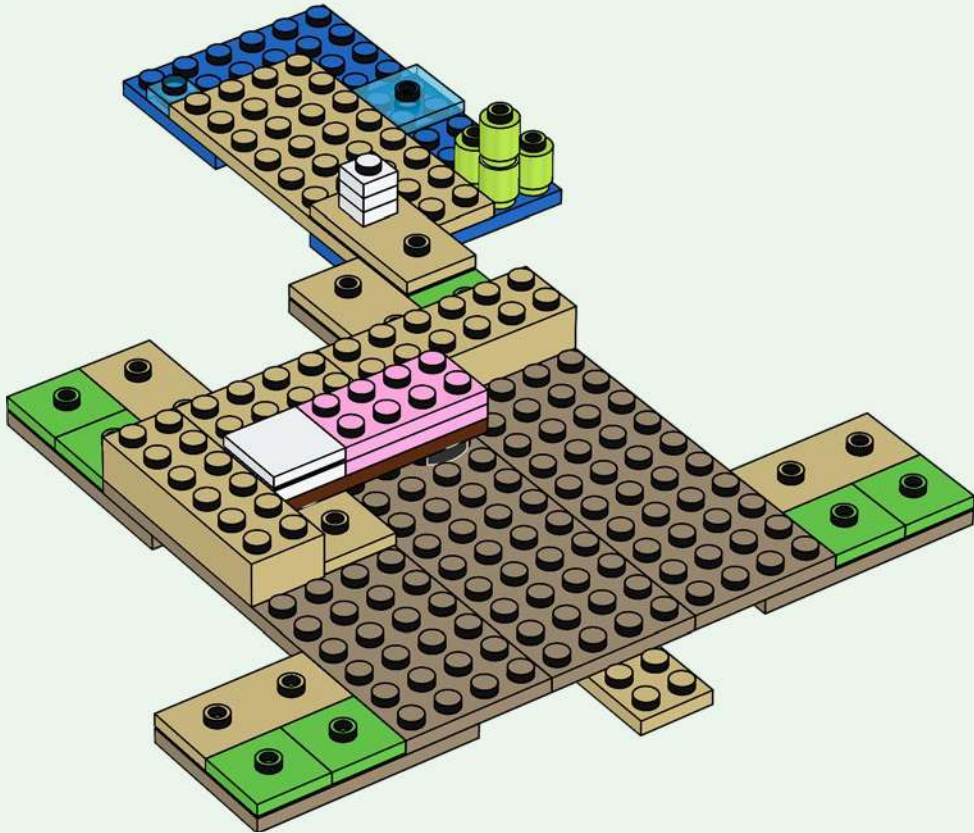

22

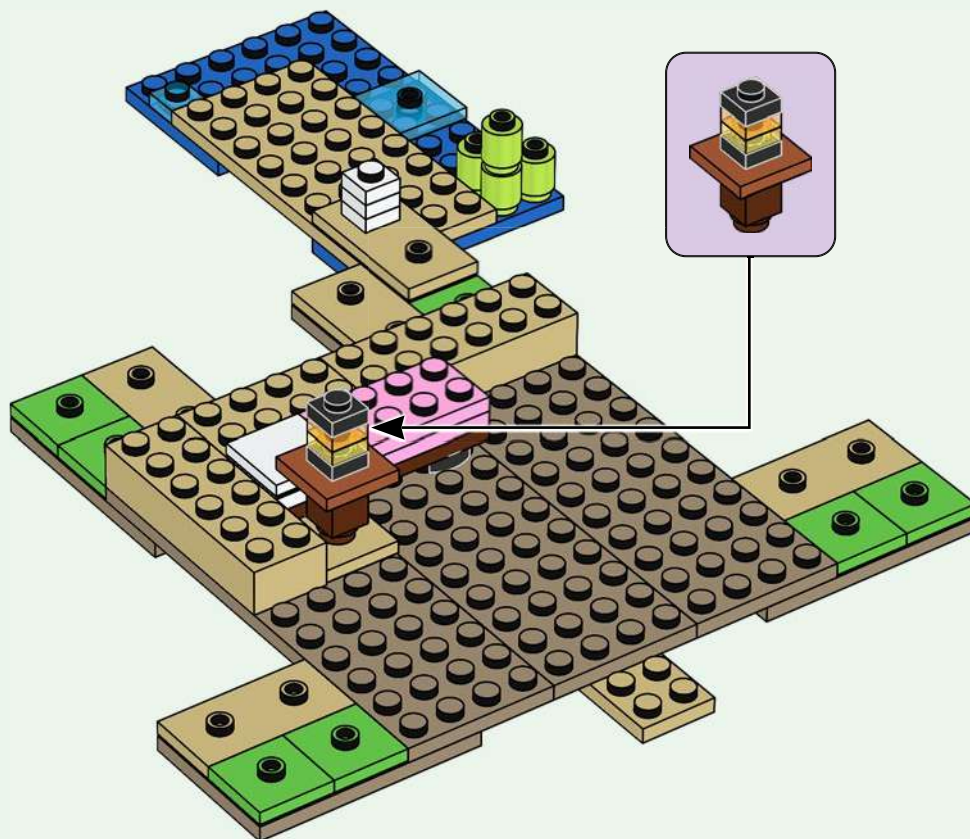

24

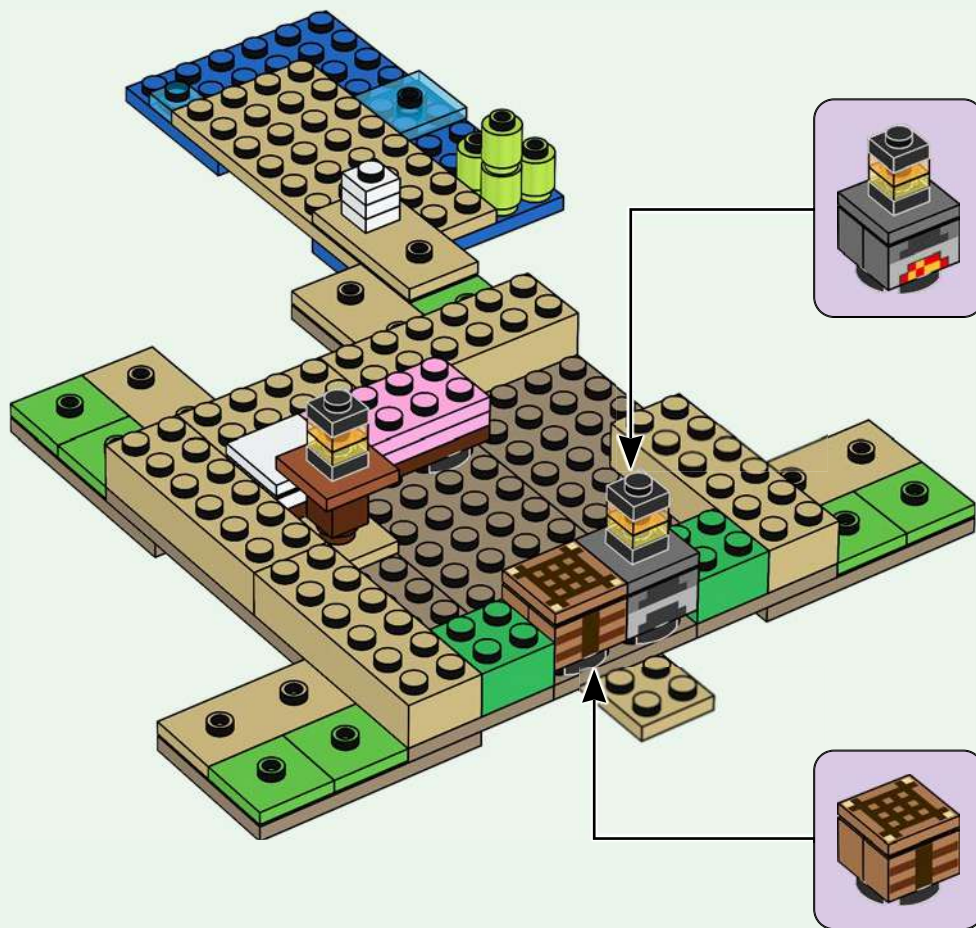

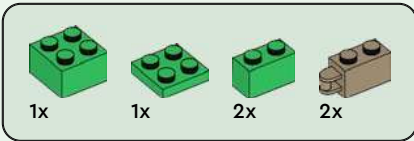

25

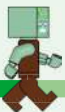
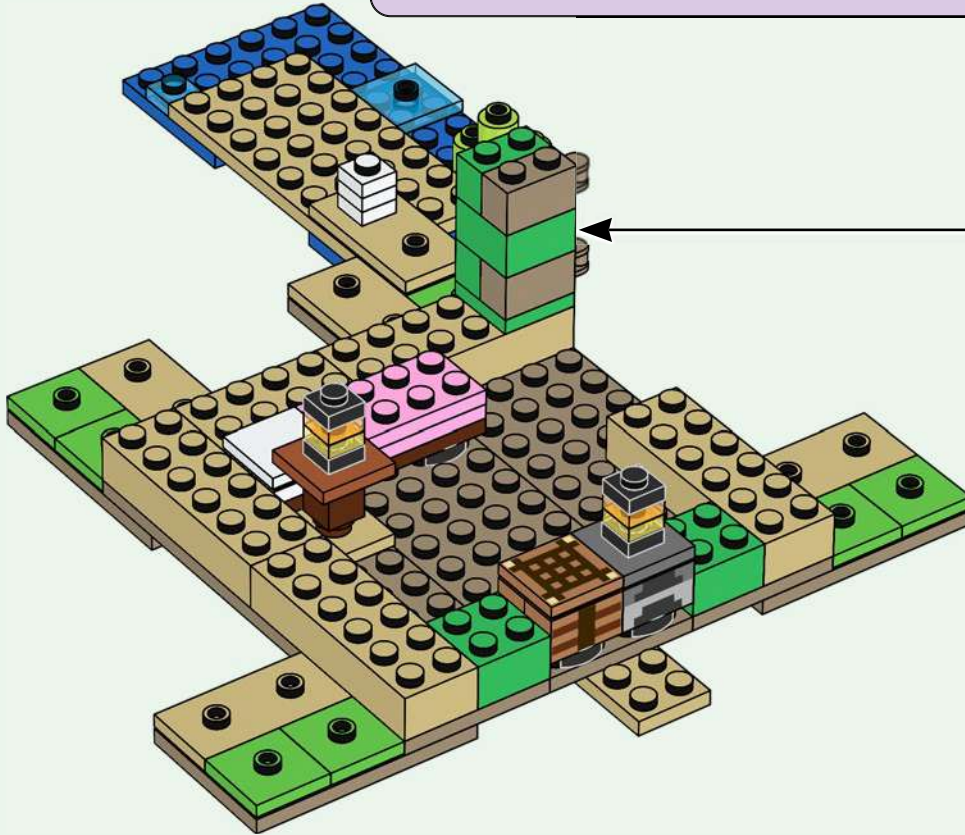
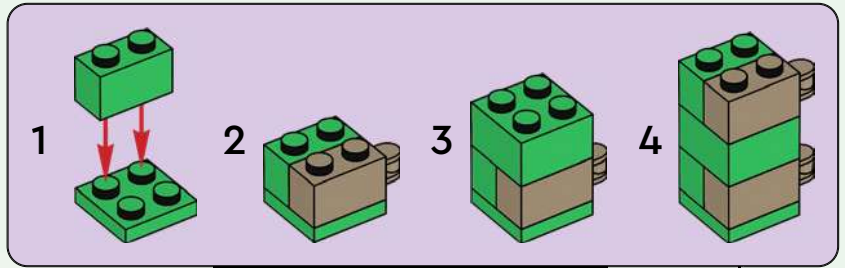



4x

26





6x

27

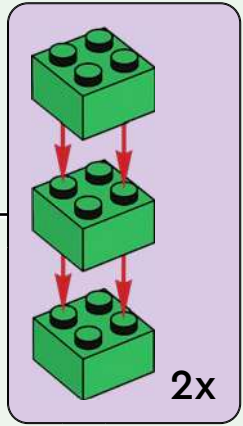
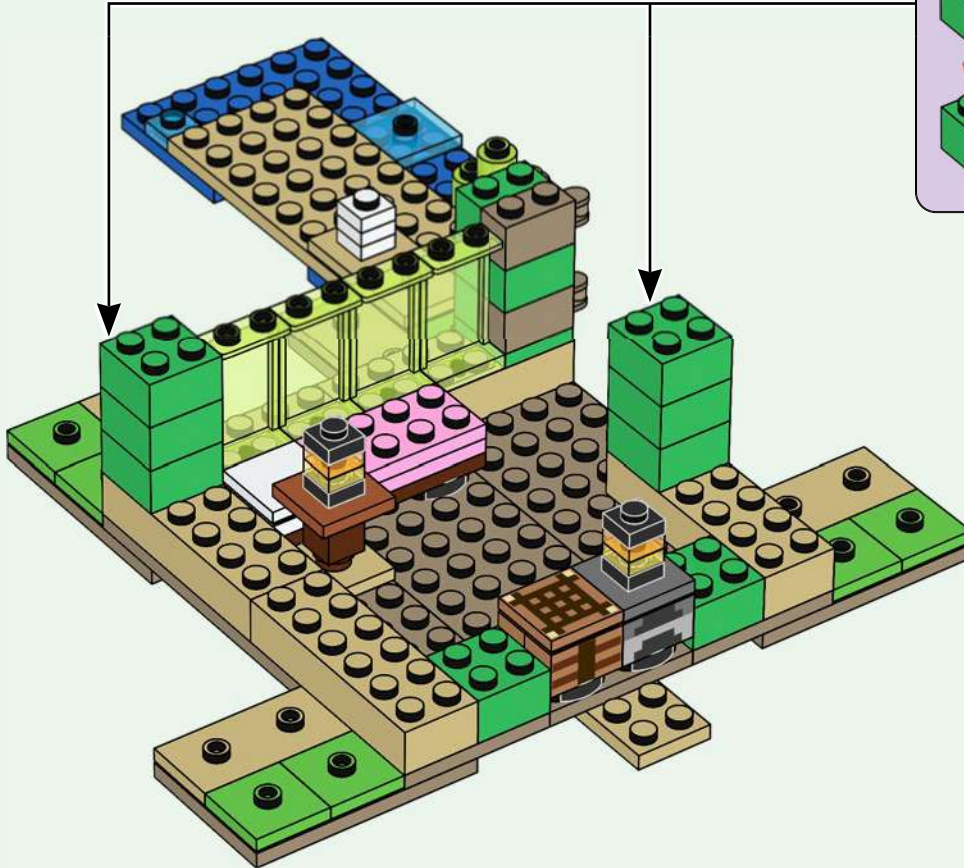

2x

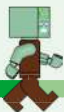



1x

28

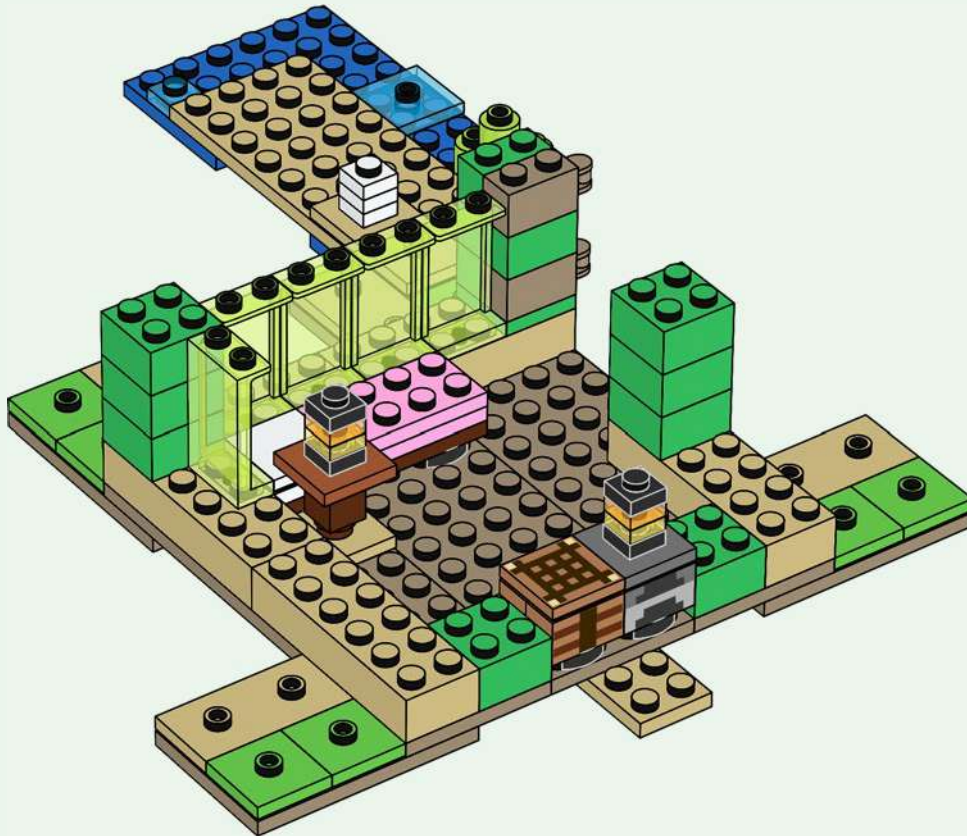



3x

29

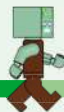
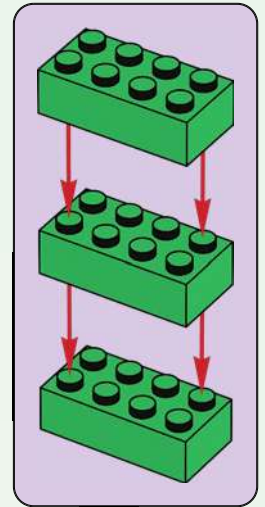
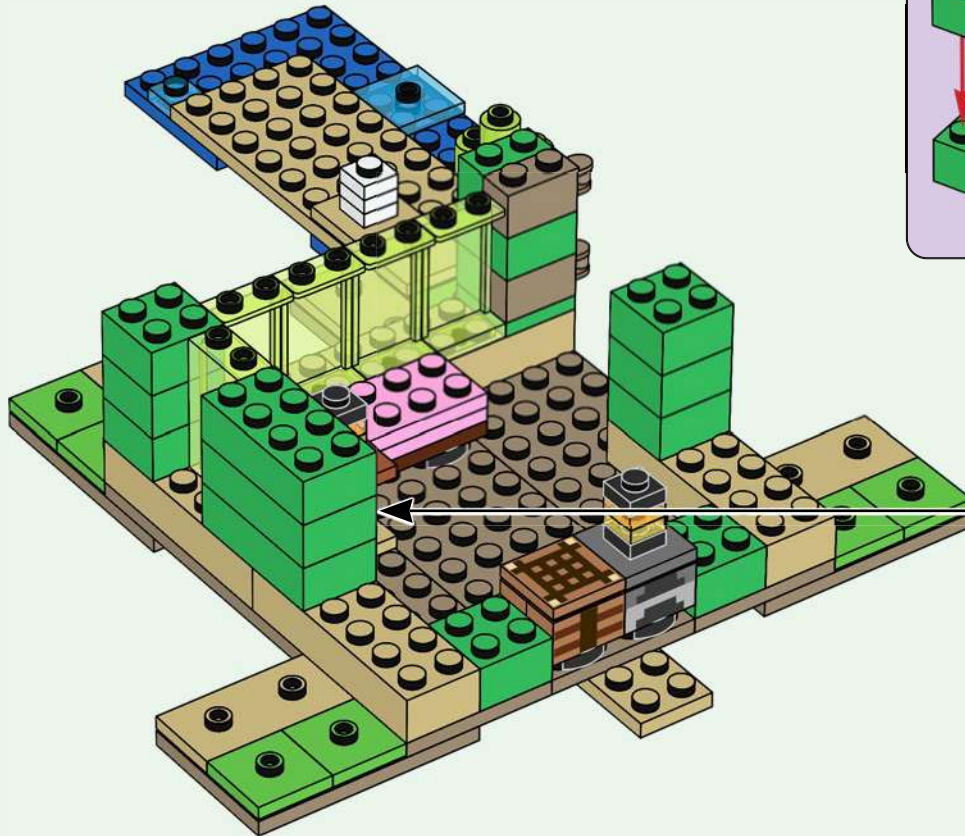

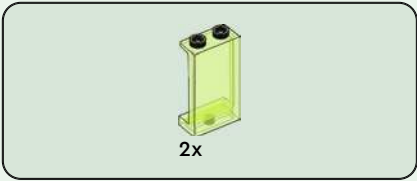

30

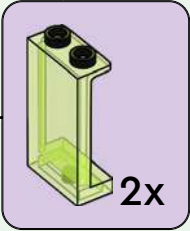
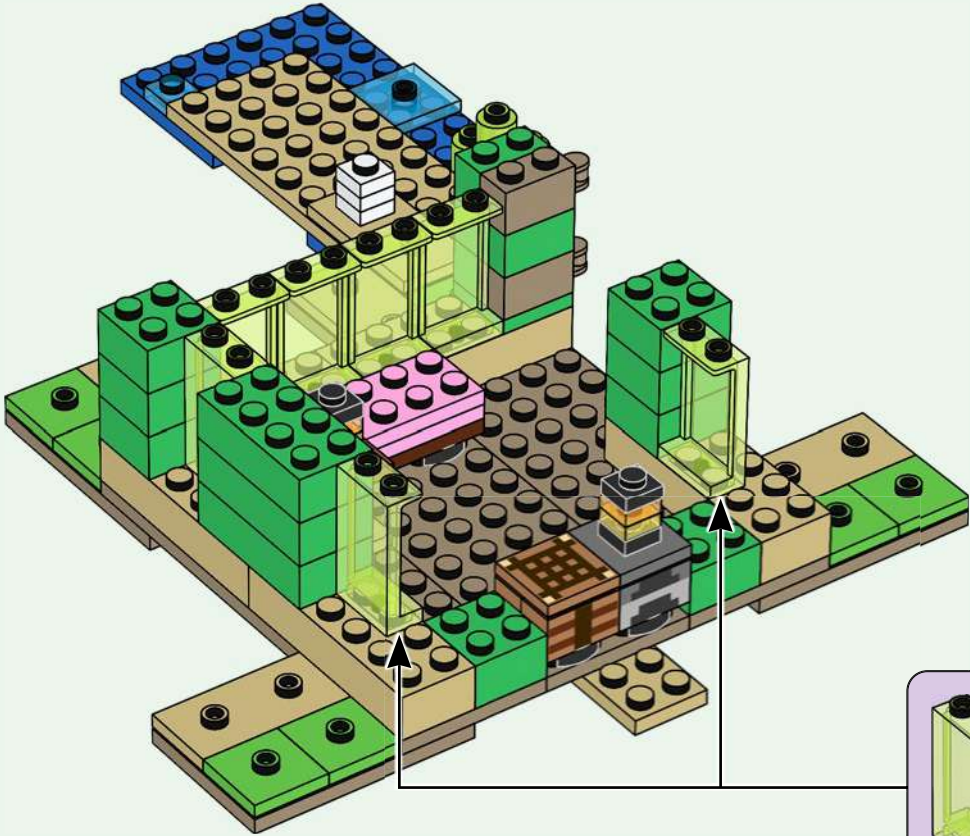

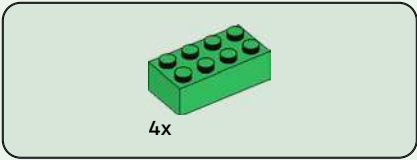

31

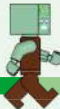
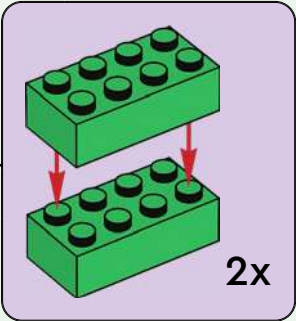
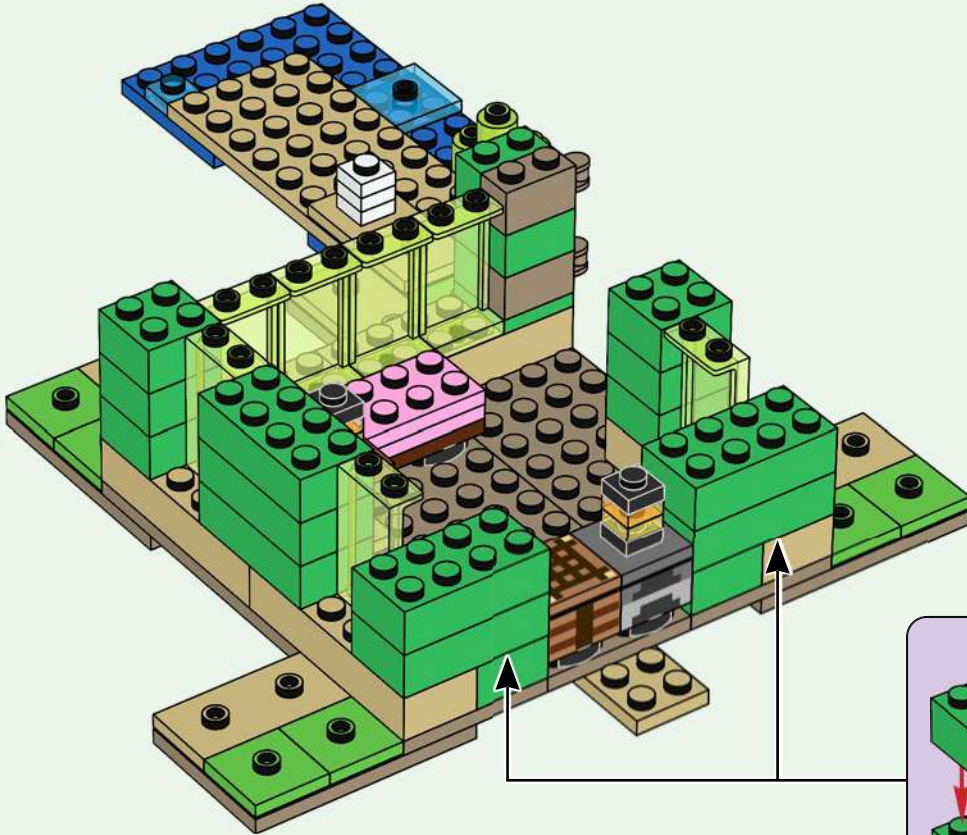

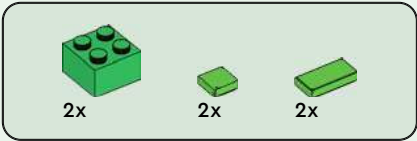

32

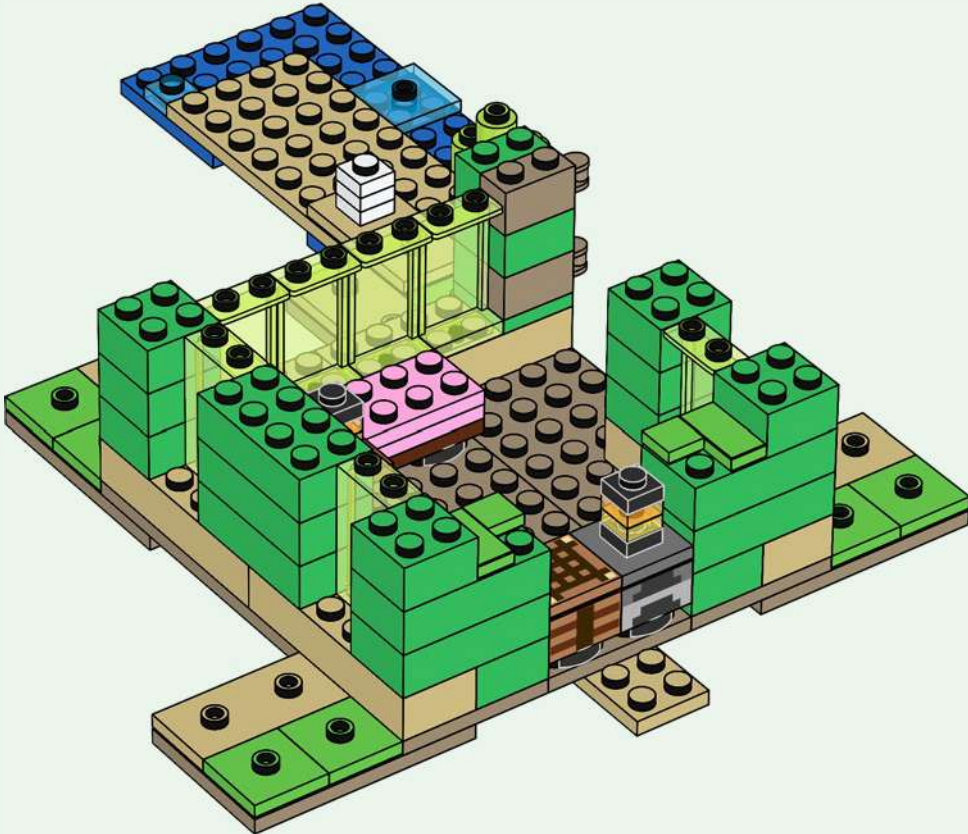

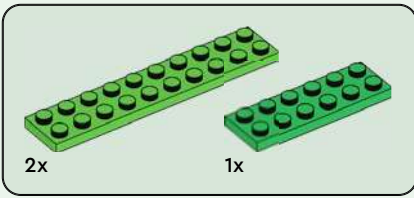

33

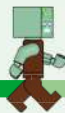
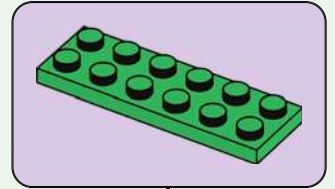
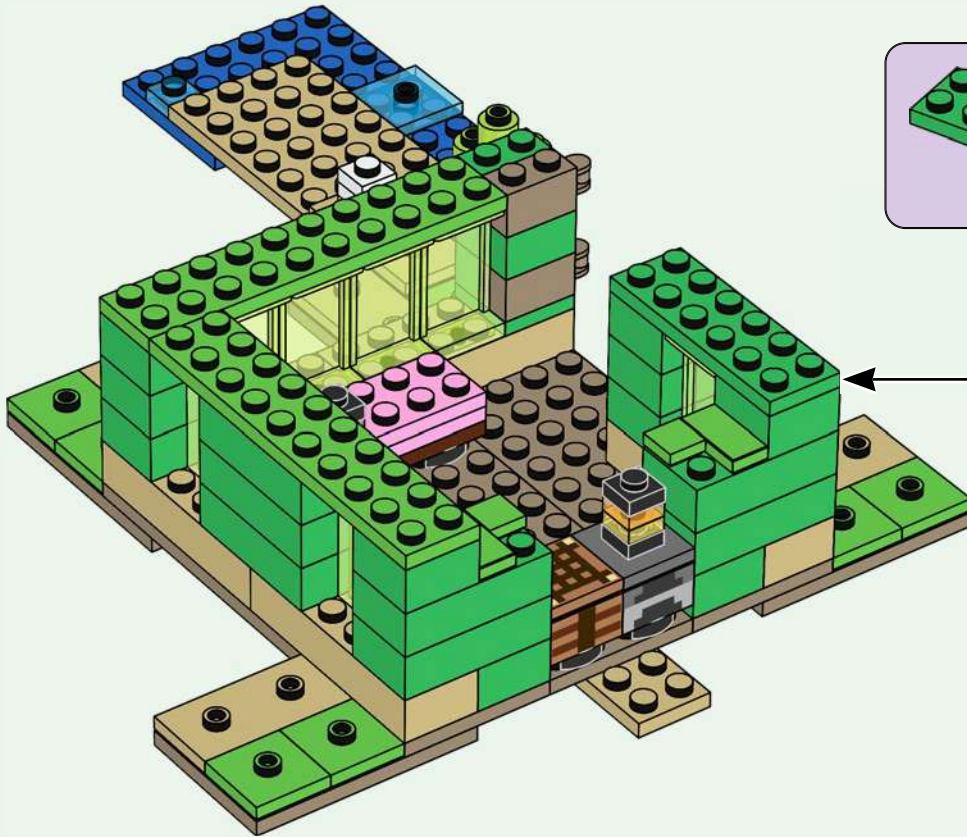

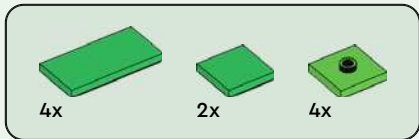

34

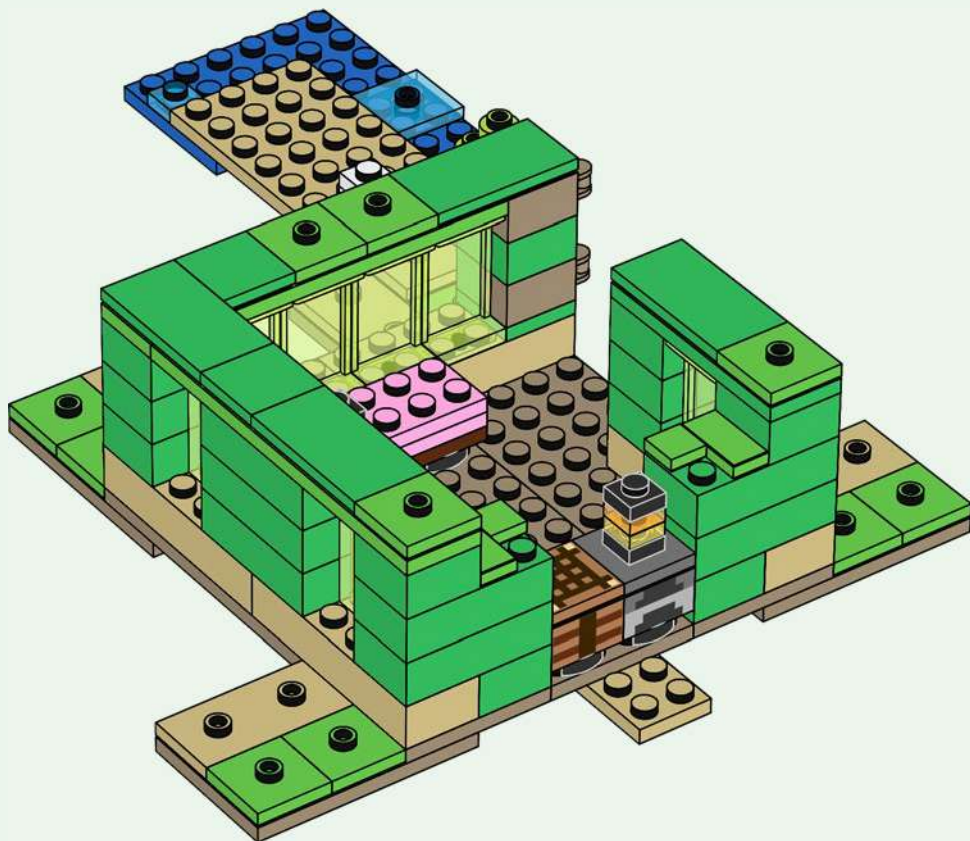

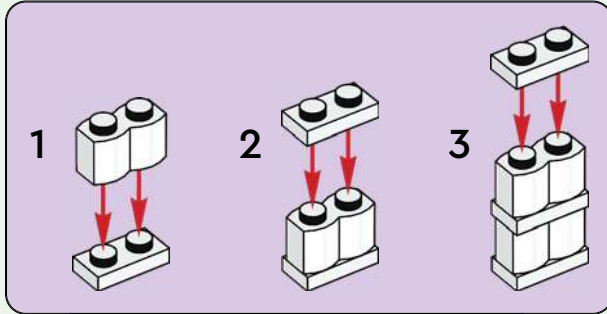
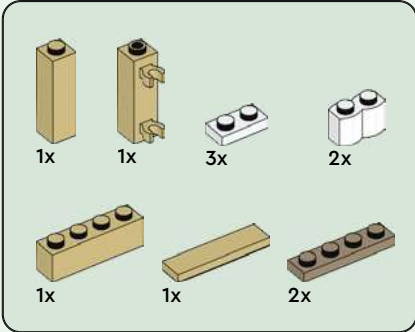

35

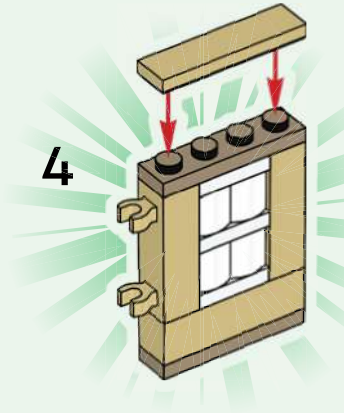
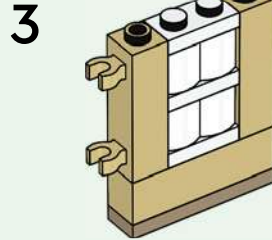
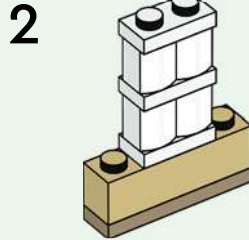
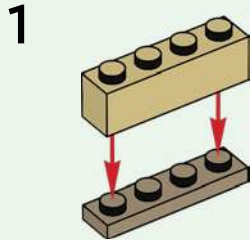

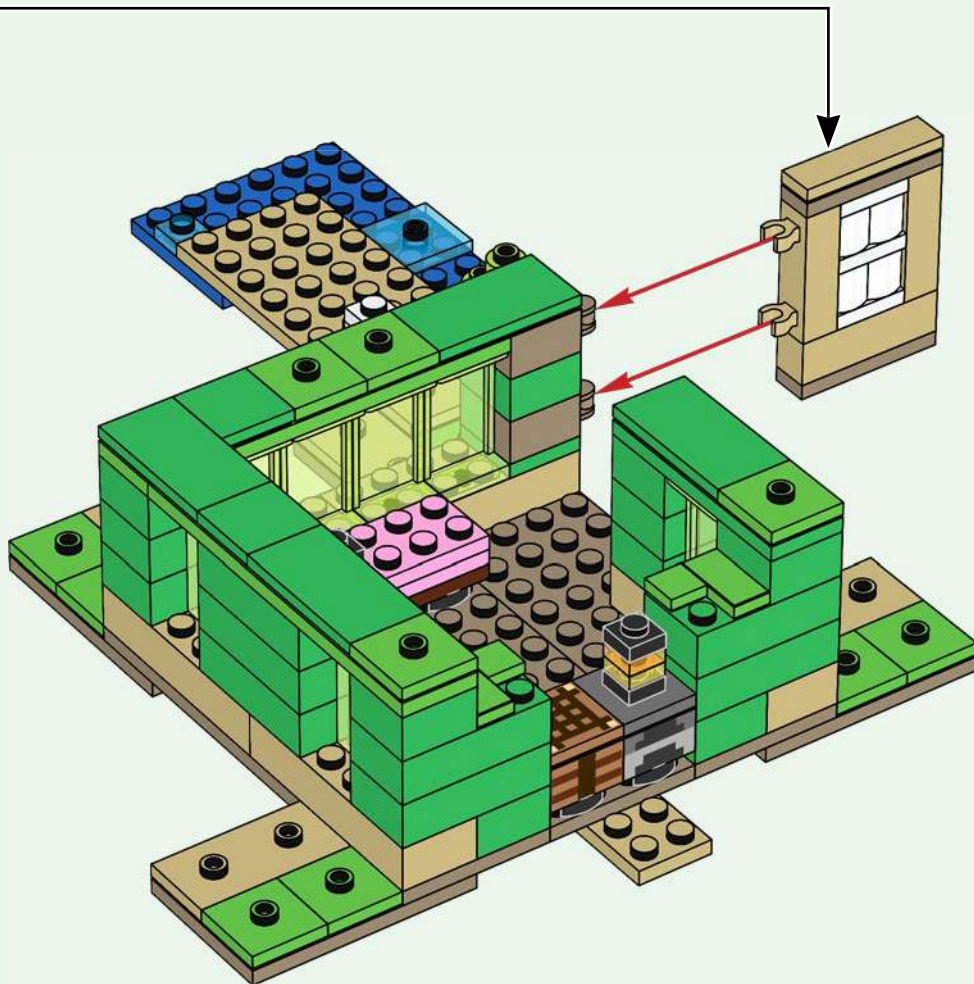

36

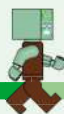
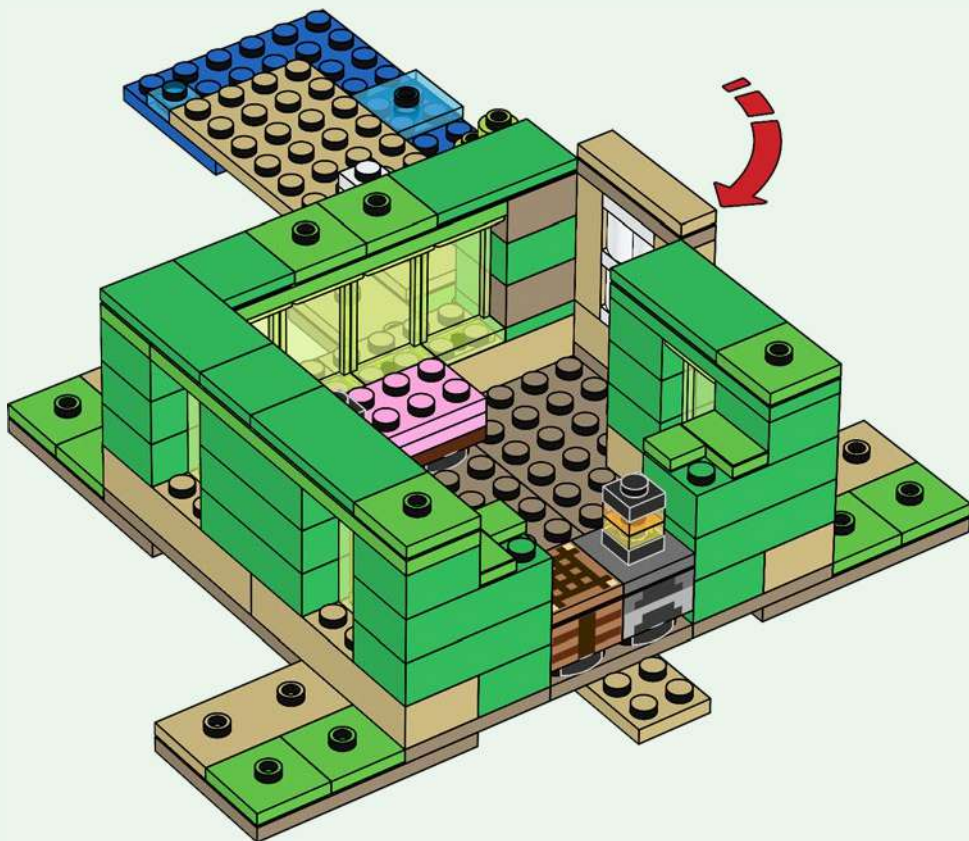

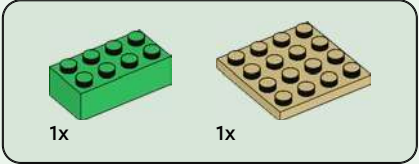
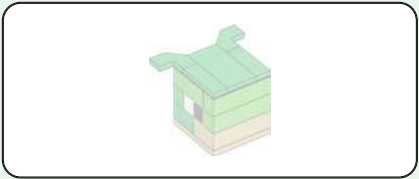

1x

1x

37

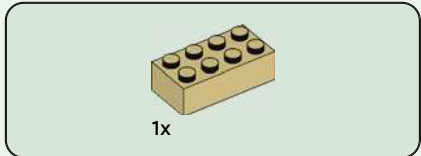
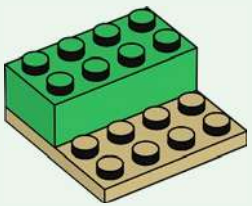

1x

38

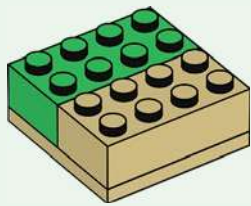



2x

39

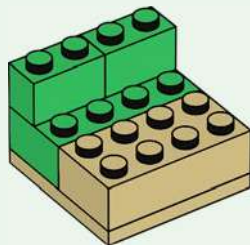

1x



1x

40

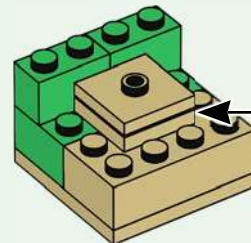
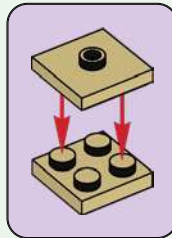

2x



2x

41

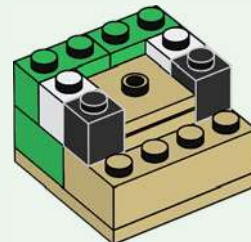

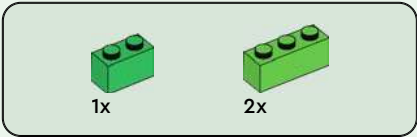

42

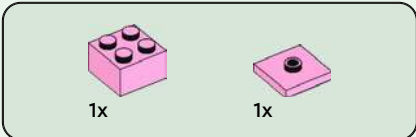
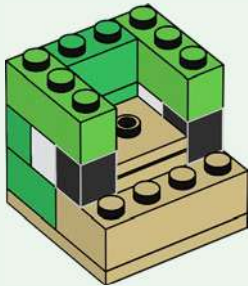

43

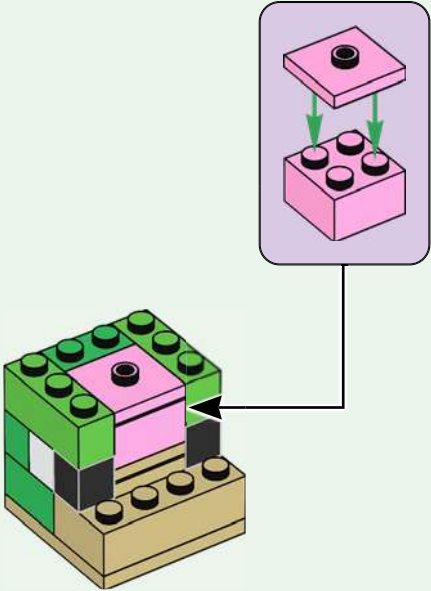

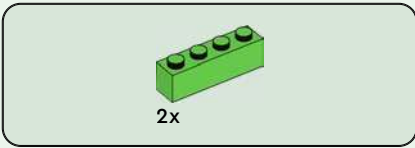

44

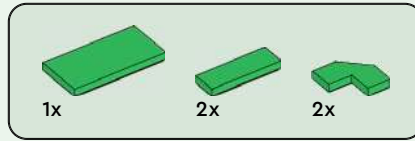
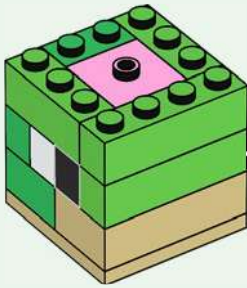
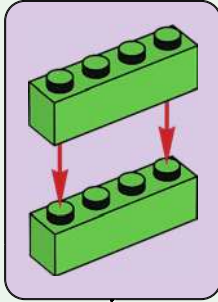

45

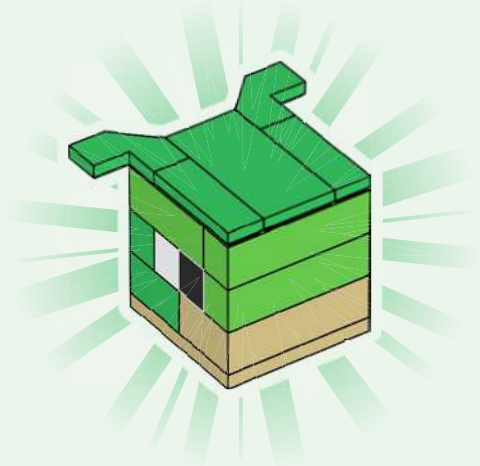

46

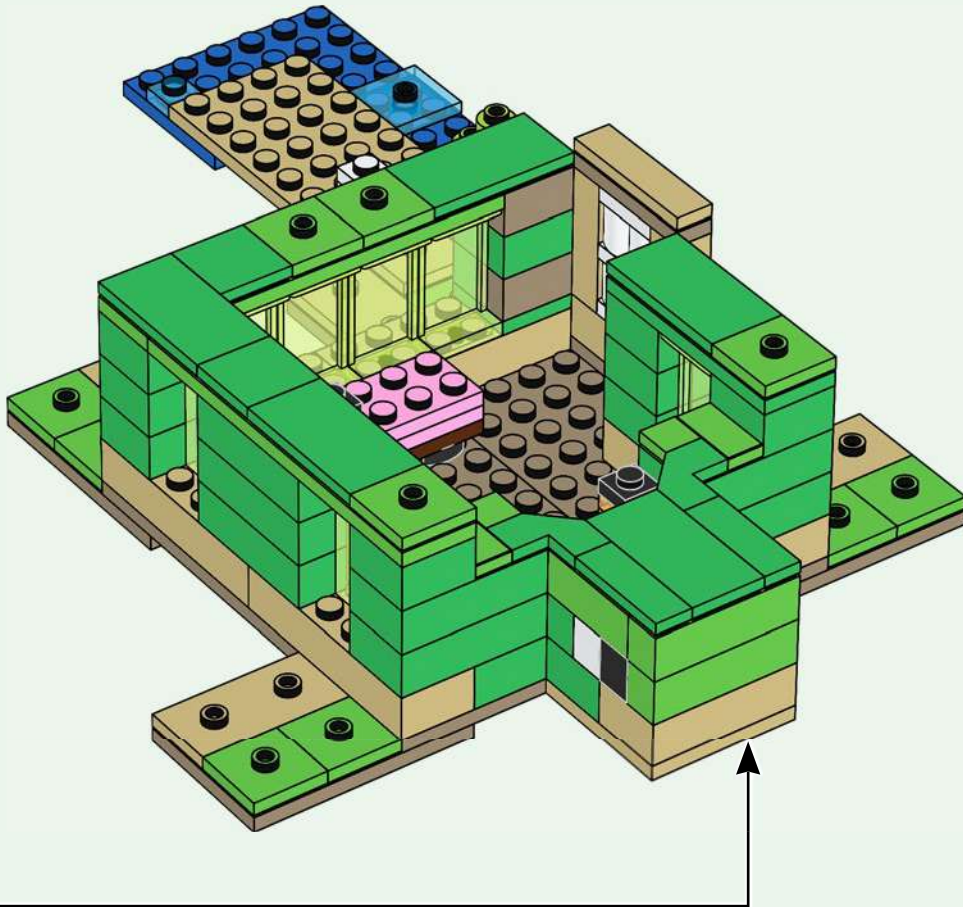

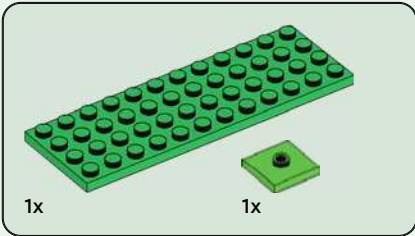
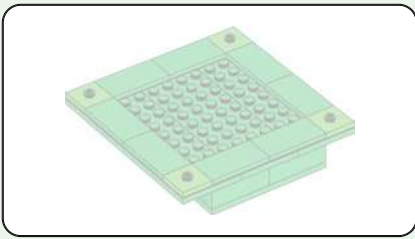

47

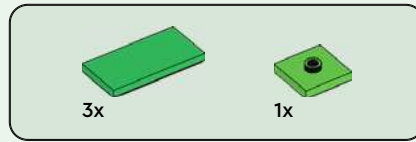
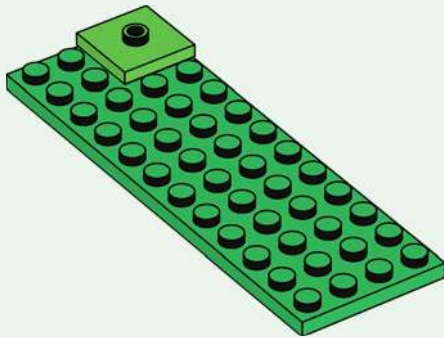

48

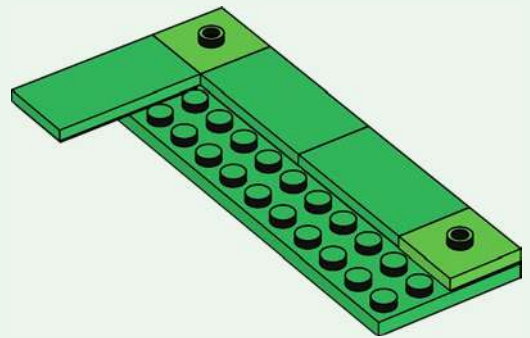

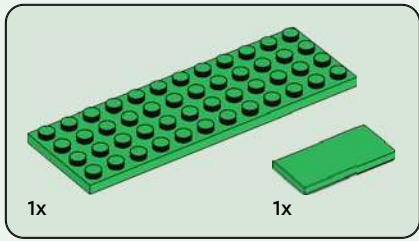

49

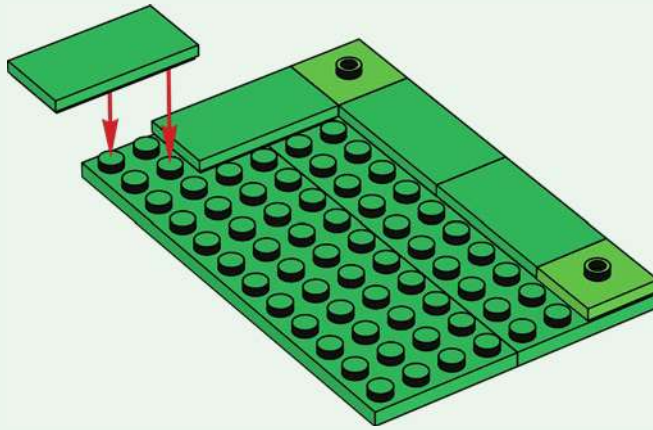

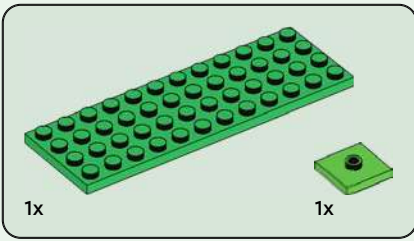

50

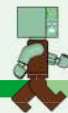
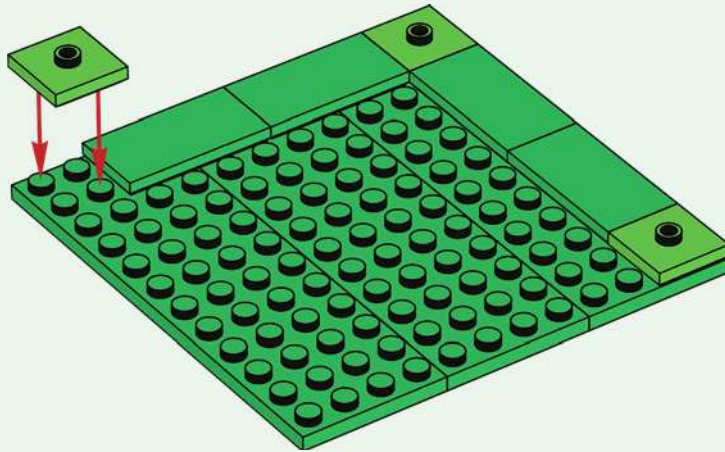

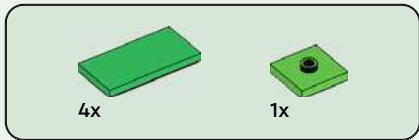

51

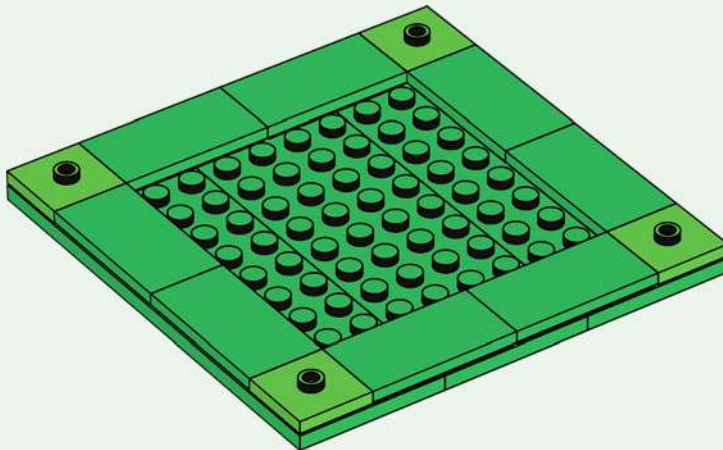

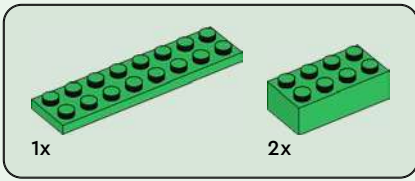

52

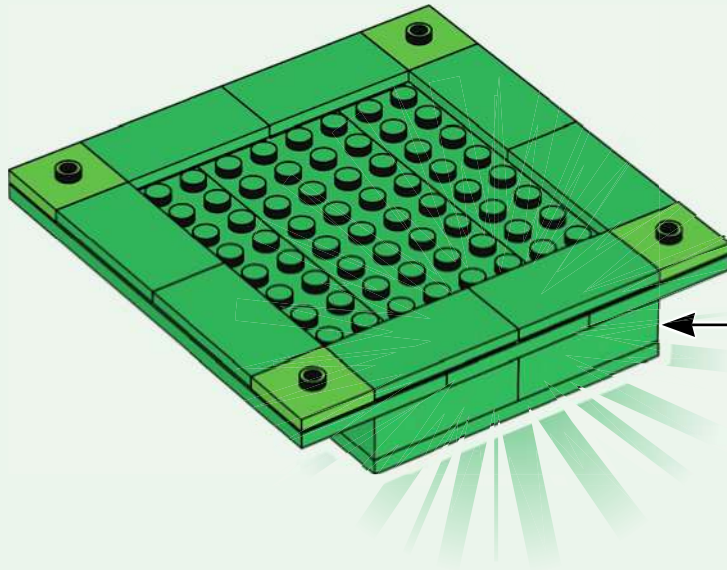
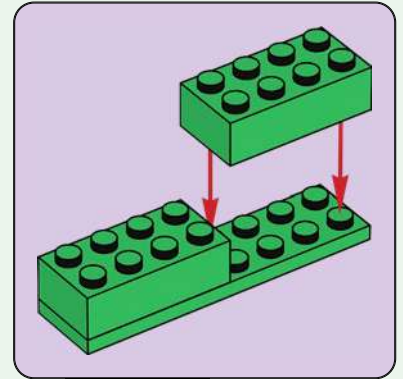

53

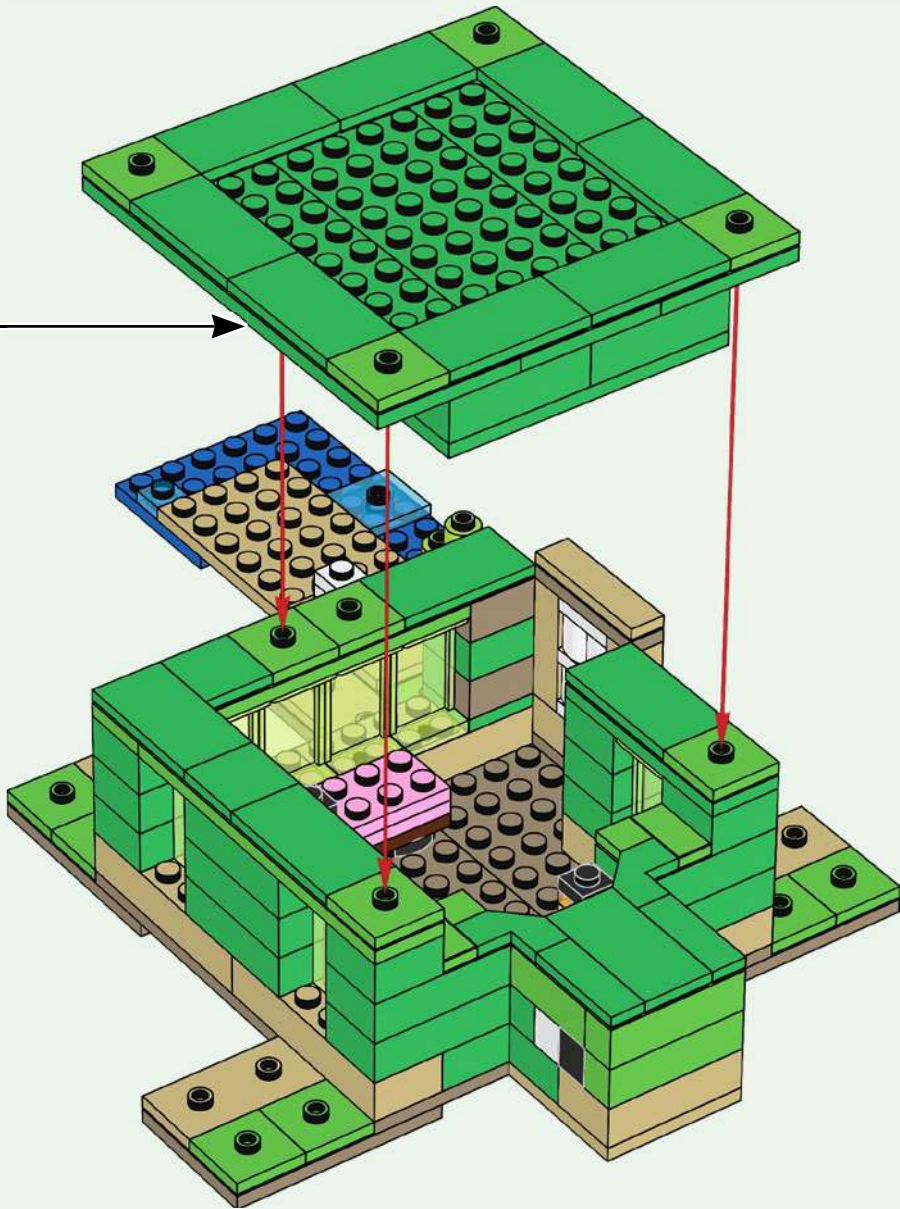





MINECRAFT

21256



21257



21251



21255



21252



21253



21254



MINECRAFT

Combine sets to expand your play!
Kombiniere Sets für noch mehr Spielspaß!
Combine les niveaux pour étendre ton expérience de jeu !
Combina i set per espandere il tuo gioco!
¡Combina sets para jugar mucho más!
Combina sets para expandir os teus momentos de diversão!
组合系列套装, 增强玩乐体验!
łącz zestawy i baw się jeszcze lepiej!

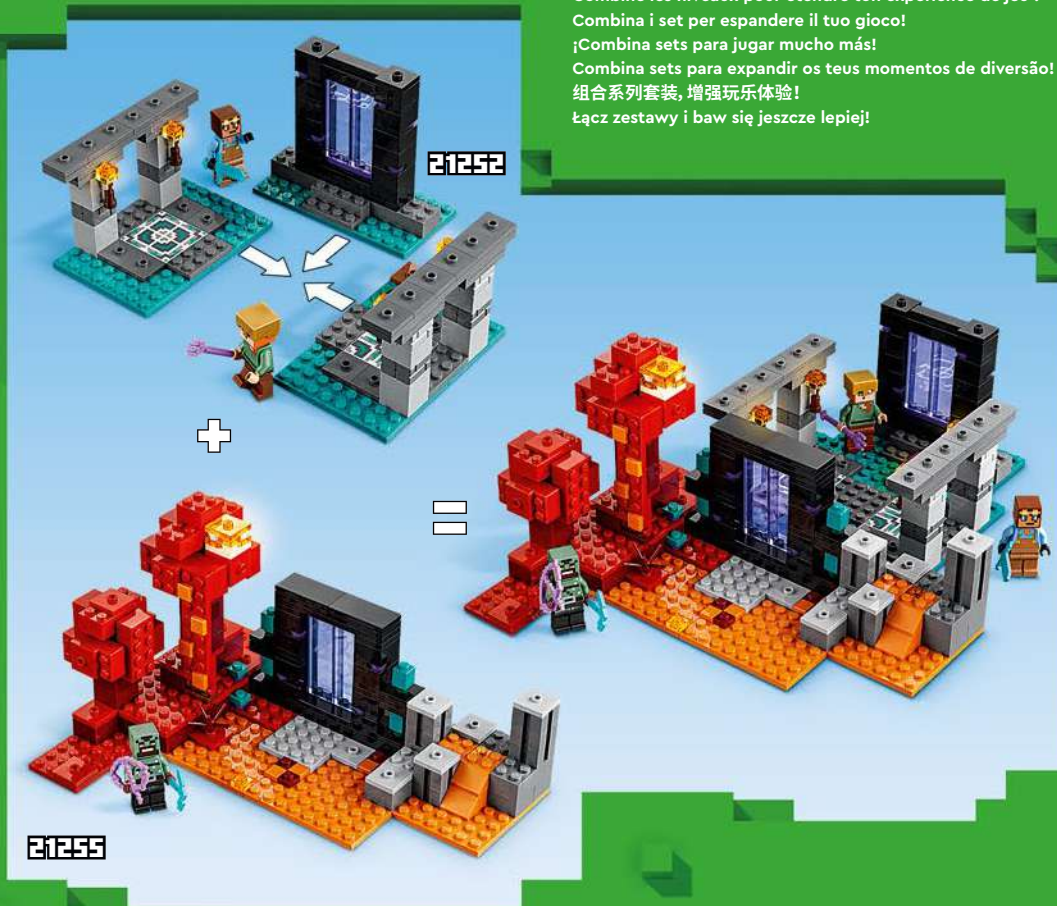

Kombinujte stavebnice a rozšiřujte svou hru!
Kombinujte stavebnice a rozšiřujte herné možnosti!
A készletek egyesítésével bővítsd a játékot!

Combină seturi pentru a-ți extinde joaca!
Комбинируйте комплекты за по-интригуваща игра!
Arvieno kompleksus, lai pilnveidotu savas rotaļas!

Kombineeri komplekte, et mängu laiendada!
Derinkite rinkinius ir išplėskite žaidimą!

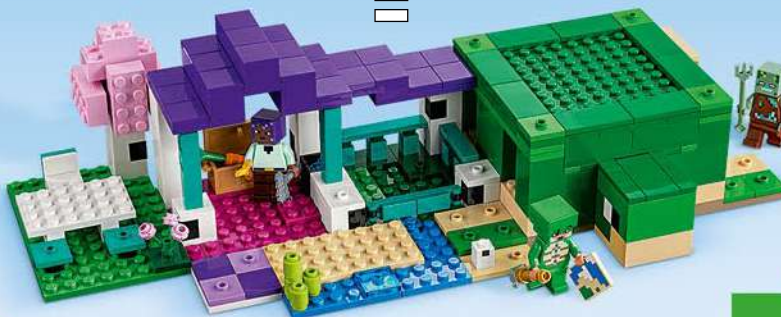
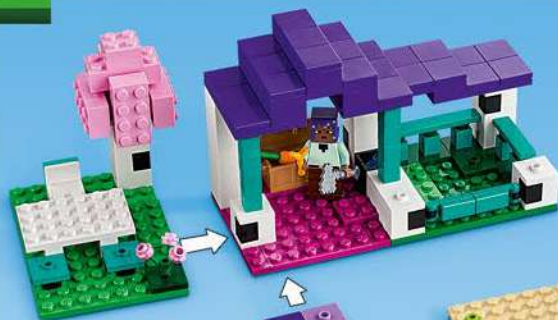



Rebuild
the
world™





Rebuild
the
world™



2x
6202501

1x
302401

2x
300501

2x
6059185

3x
302301

1x
306801



1x
302201

2x
4117070

8x
6443061

2x
6468818

1x
6057517

1x
6320357

1x
4278422

1x
6024495

2x
4565387

1x
4114084

1x
6385114

1x
6170776

3x
6468819

1x
4113916

1x
4550324

5x
6294227

2x
4114319

3x
4114309

1x
4243824

4x
4181134

1x
4509897

1x
302223

2x
303223

4x
302426

2x
300526

4x
403226

2x
6272184

4x
6253140

1x
6269971

5x
4107736

11x
300328

2x
4107762

1x
302228

2x
6385275

2x
6023083

3x
6468474



1x
6253139

13x
4566179

10x
4106356

1x
379528

1x
303428

3x
4279059

1x
6434871

2x
6253176

2x
6172375

4x
6347296

1x
6368255

6x
6195258

1x
6336574

16x
6389695

2x
6343280

1x
6470514

1x
6468470

2x
6310856

2x
6462430

3x
6468821

1x
6382577

2x
6315197

1x
6252041

1x
6252044

1x
6382531

2x
6252045

4x
4212454

1x
6281999

3x
6209682

2x
6310836

2x
4626904

4x
6167894

3x
6114515

1x
6347366

1x
6335312

2x
6252040

2x
4216581

2x
4211242

1x
4221886

1x
6336857

1x
4211247

2x
4211406

1x
6216862

1x
6216860

1x
6126083

1x
6055169

1x
6251842

1x
4550359

2x
6204535

1x
4538126

7x
6468820

2x
6097024

1x
6097003

2x
6186030



 [LEGO.com/service](https://www.LEGO.com/service)

YOU COULD **WIN**



Scan this QR code or go to **LEGO.COM/PRODUCTFEEDBACK** and give us your short feedback about this LEGO® set for a chance to win a cool LEGO prize.

Terms and Conditions apply*

EN: YOU COULD WIN. Terms and Conditions apply* **DE: Du könntest GEWINNEN.** Es gelten die Teilnahmebedingungen* **FR: Tu pourrais GAGNER.** Des conditions s'appliquent* **IT: Potresti VINCERE tu.** Termini e condizioni sono applicabili* **ES: Puedes GANAR.** Aplican términos y condiciones* **PT: Poderá GANHAR.** Aplicam-se termos e condições* **ZH: 轻松获奖. 条款和条件适用*** **PL: Szansa na WYGRANĄ.** Obowiązują warunki korzystania* **CS: Máte šanci VYHRÁT.** Platí všeobecné smluvní podmínky* **SK: Máte šancu VYHRAŤ.** Platia všeobecné zmluvné podmienky* **HU: TE IS NYERHETSZ.** Felhasználási feltételek érvényesek* **RO: Ai putea CÂȘTIGA.** Se aplică termeni și condiții* **BG: Можете да СПЕЧЕЛИТЕ.** Има определени правила и условия* **LV: Tu vari LAIMĒT.** Ir spēkā noteikumi un nosacījumi.* **ET: Sul on võimalus VÕITA.** Kehtivad tingimused* **LT: Jūs galite LAIMĖTI.** Taikomos sąlygos*

*[LEGO.com/productfeedback-terms](https://www.lego.com/productfeedback-terms)

LEGO and the LEGO logo are trademarks of the LEGO Group. ©2024 The LEGO Group.

© 2024 Mojang AB. All Rights Reserved. Minecraft, the Minecraft logo, the Mojang Studios logo and the Creeper logo are trademarks of the Microsoft group of companies.

6495801