



NINJAGO

71784





LEGO.com/sustainable-packaging

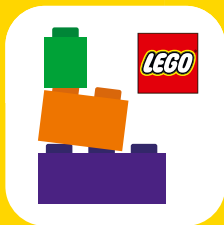

BUILDER



Apple and the Apple logo are trademarks of Apple Inc., registered in the U.S. and other countries and regions. App Store is a service mark of Apple Inc. Google Play and the Google Play logo are trademarks of Google LLC. Tencent and the Tencent logo are trademarks of Tencent Inc.

 LEGO.com/devicecheck

EN Ask parents' permission before going online | **DE** Eltern um Erlaubnis bitten, bevor du online gehst | **FR** Demande l'autorisation d'un parent avant d'aller en ligne | **IT** Chiedi il permesso ai tuoi genitori prima di andare online | **ES** Pídeles permiso a tus papás antes de conectarte a Internet | **PT** Pede autorização aos pais antes de acederes online | **JA** オンラインになる前に ほご者の方のきよかをもらおう | **ZH** 上网前应先征得父母的同意 | **KO** 온라인 접속 전에 보호자 동의를 필요합니다 | **RU** Спроси разрешения у родителей, прежде чем заходить в интернет | **PL** Poproś rodziców o zgodę, zanim wejdiesz do Internetu | **CS** Než půjdeš na internet, požádej rodiče o svolení | **SK** Skôr než pôjdeš na internet, vypýtaj si povolenie od rodičov | **HU** Kérj szülői engedélyt, mielőtt online csatlakoznál! | **RO** Cere permisiunea părinților înainte de a te conecta online | **BG** Поискайте разрешение от родител, преди да влезете онлайн | **LV** Pirms došanās tiešsaistē palūdz atļauju vecākiem | **ET** Enne Interneti kasutamist küsi vanematelt luba | **LT** Prieš prisijungdami prie interneto, atsiklauskite tėvų



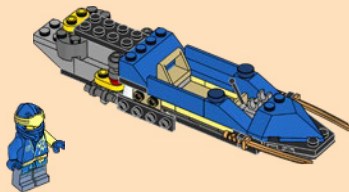
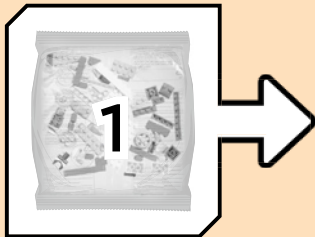

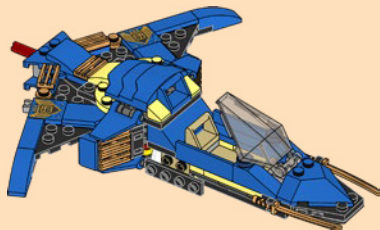
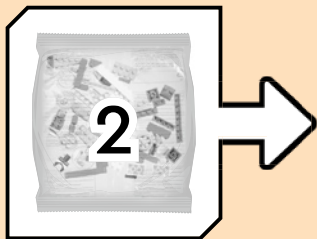

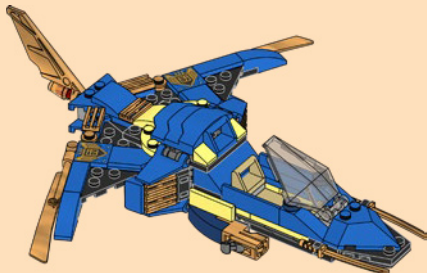

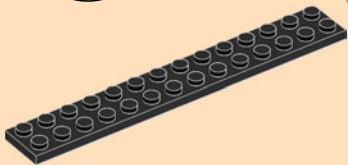

1x



1

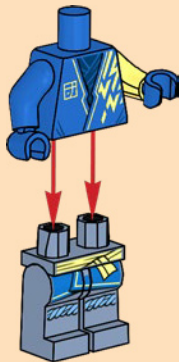

2

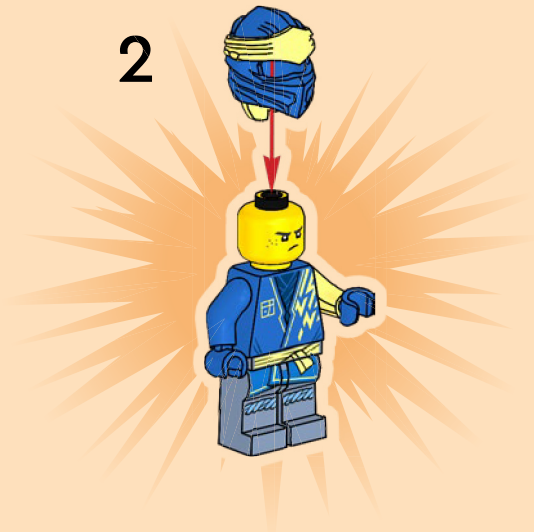

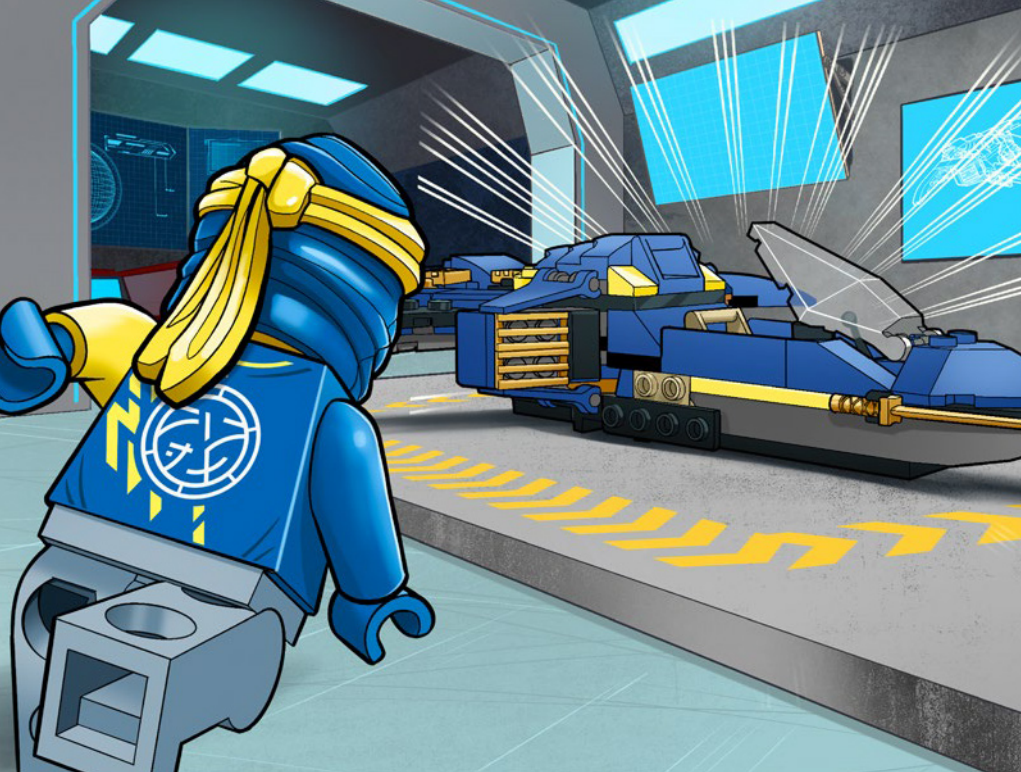



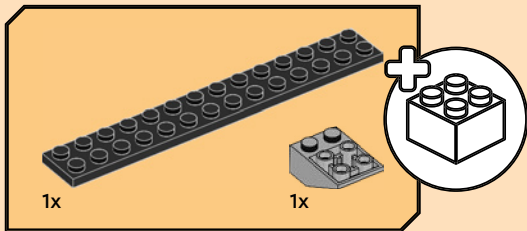

1

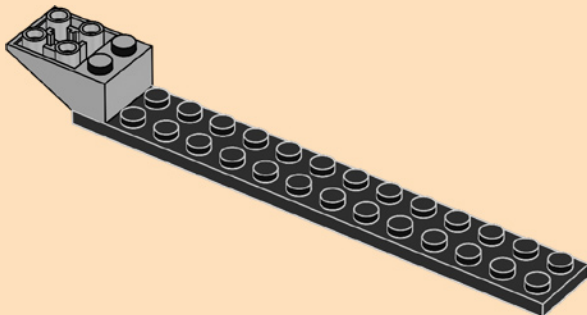

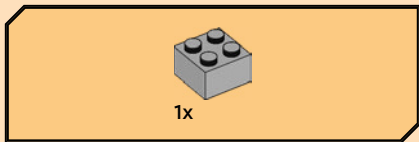

2

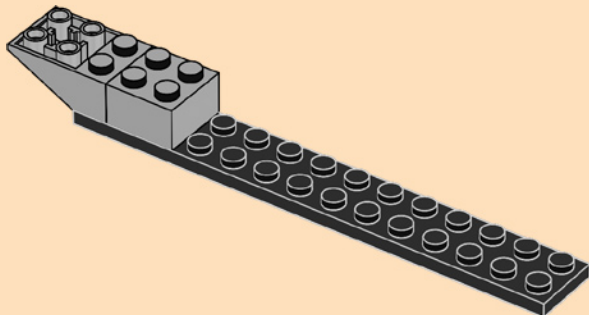

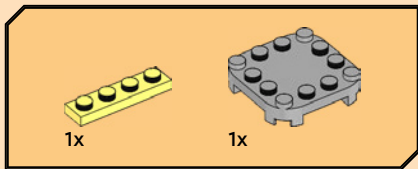

3

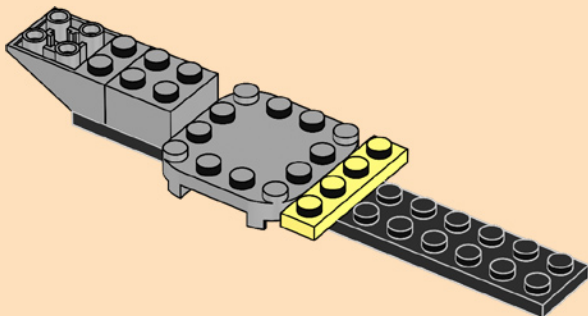

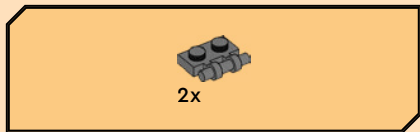

4

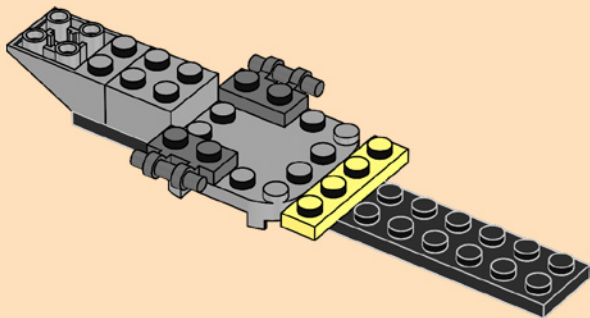

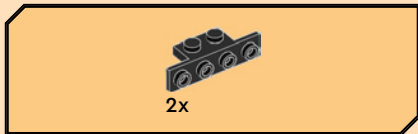

5

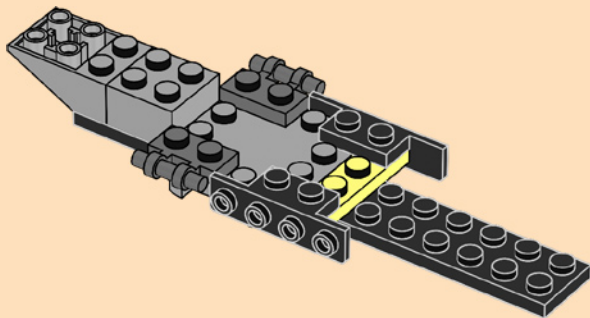



6

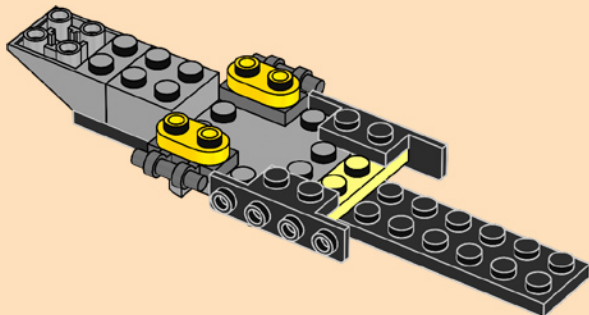



7

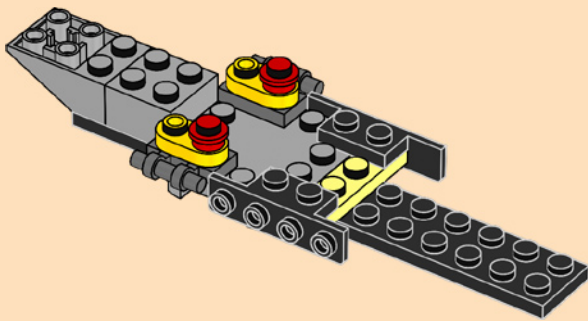



8

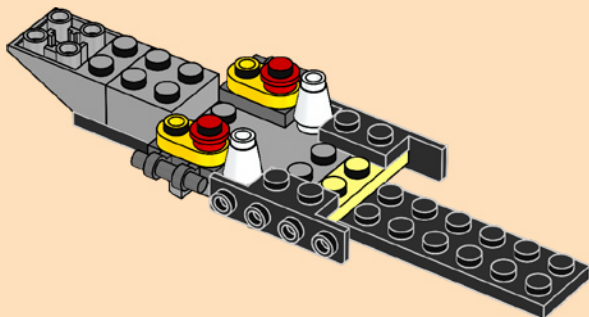

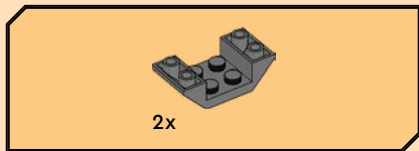

9

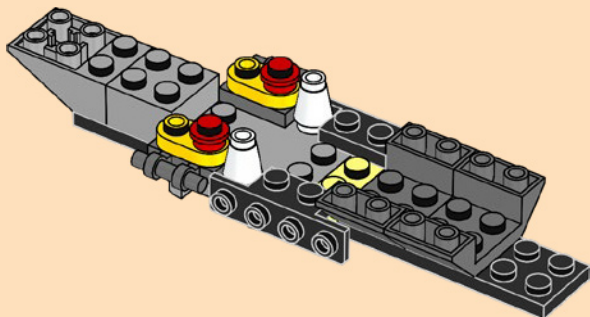

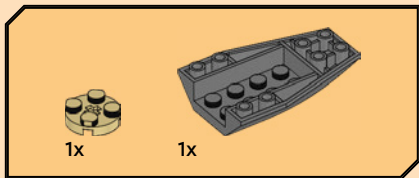

10

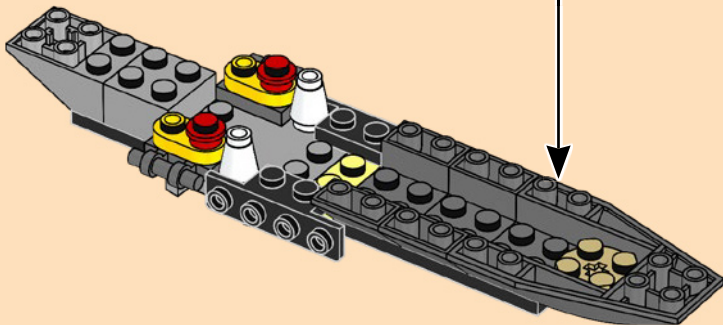
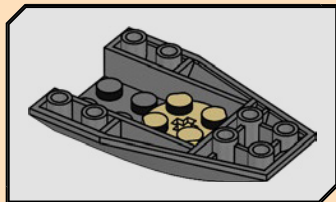

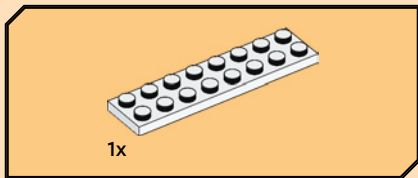

11

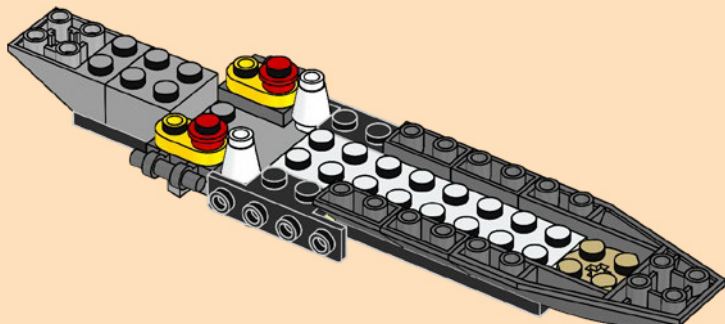



2x

12

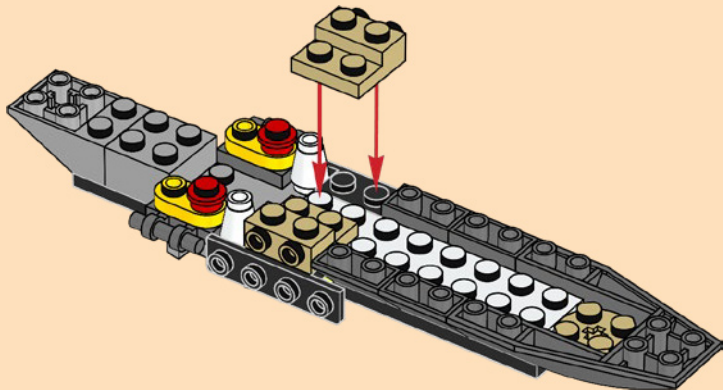

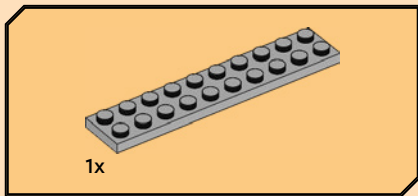

13

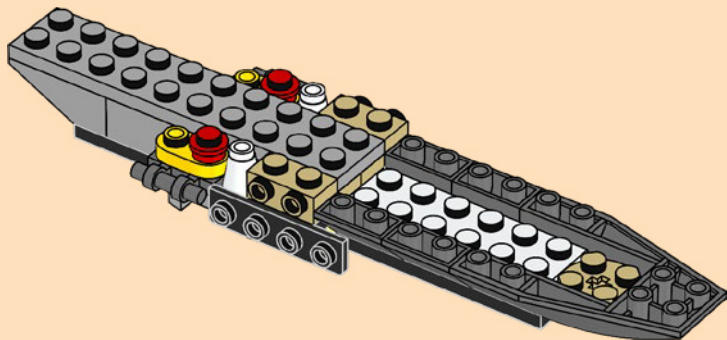

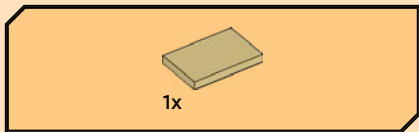

14

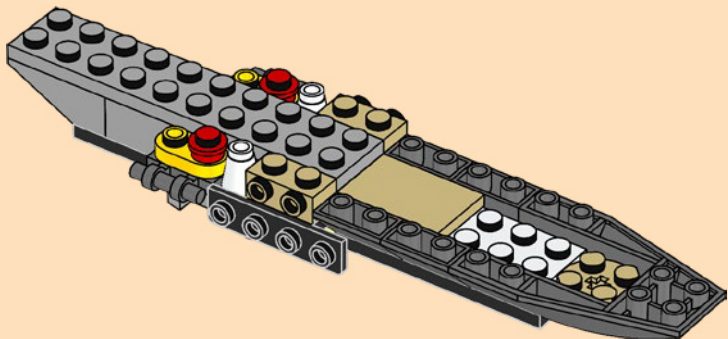

24

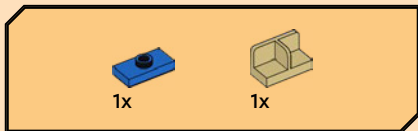

15

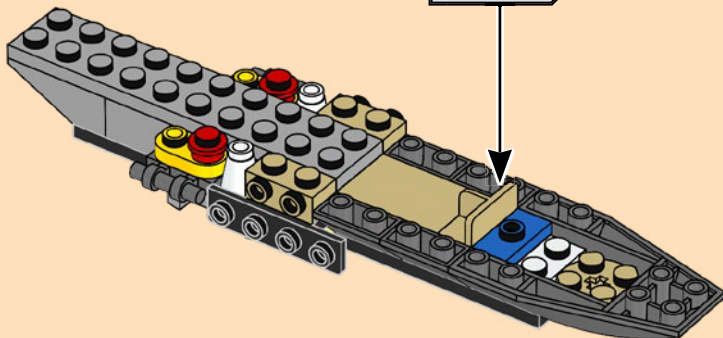
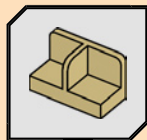

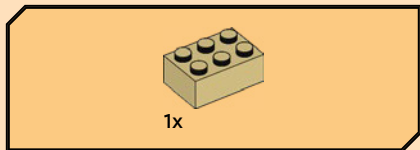

16

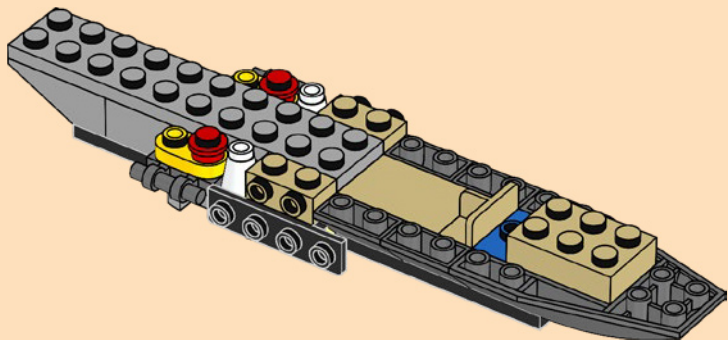

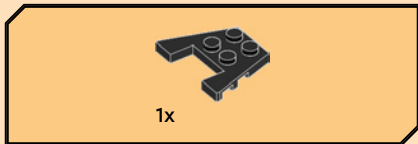

17

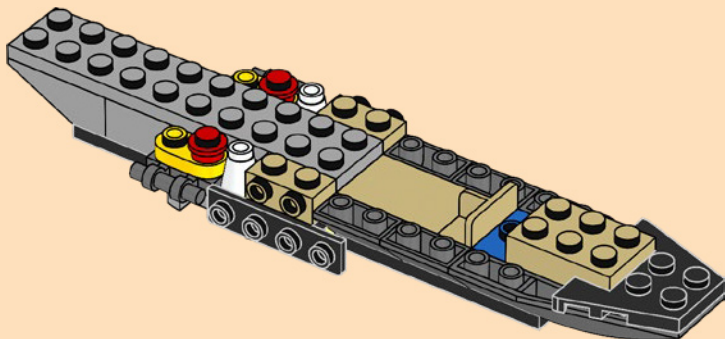



2x

18

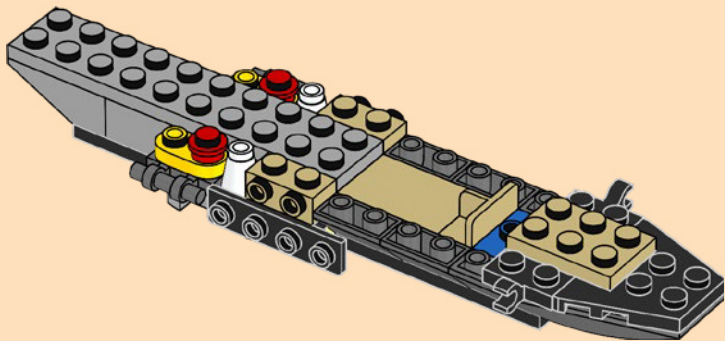

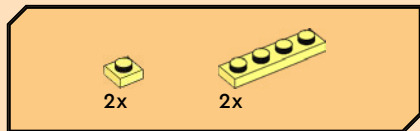

19

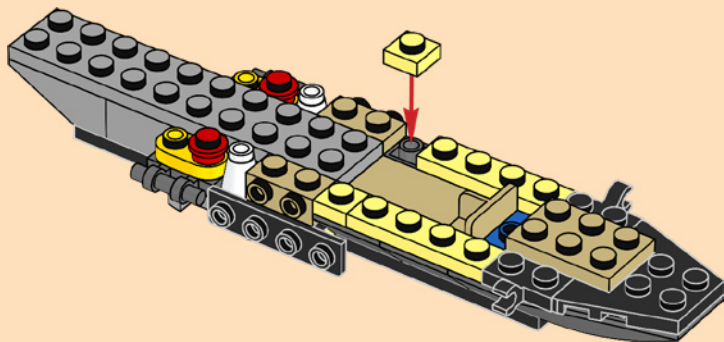



2x

20

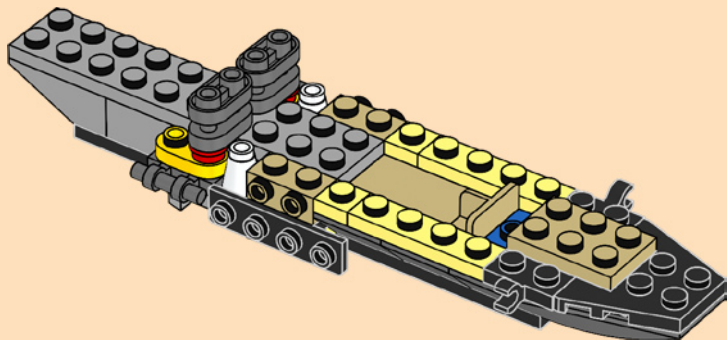

30

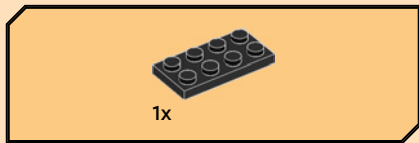

21

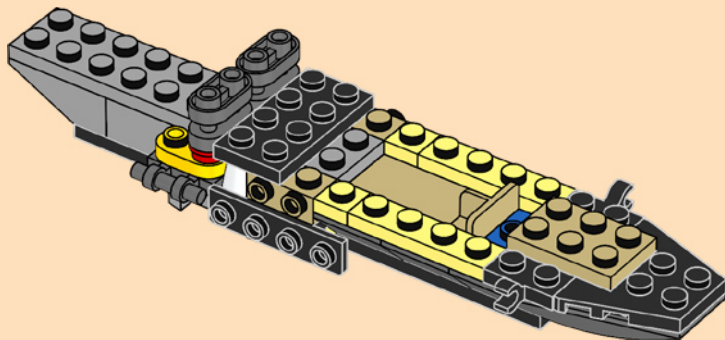

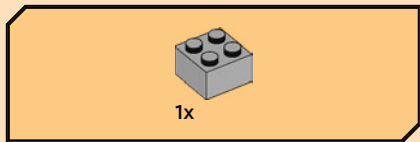

22

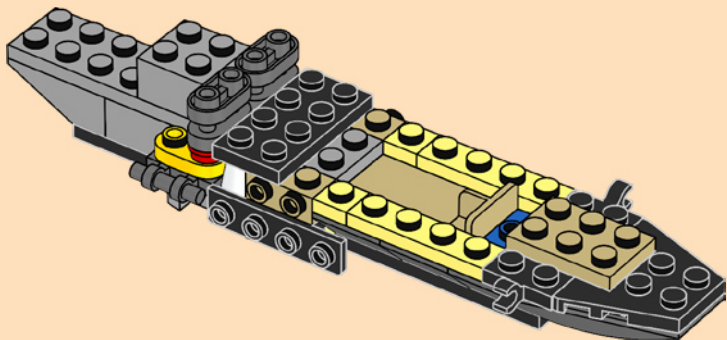



2x

23

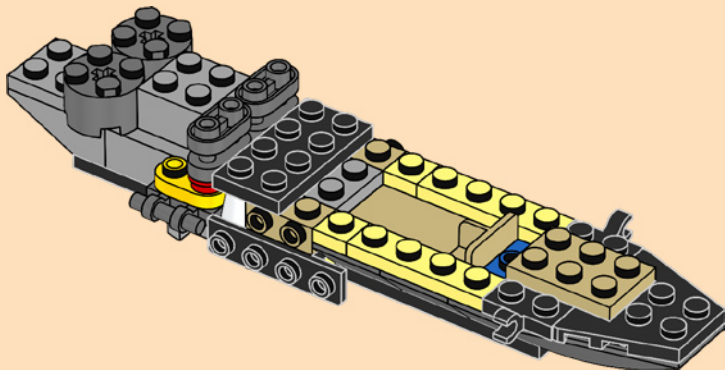



1x

24

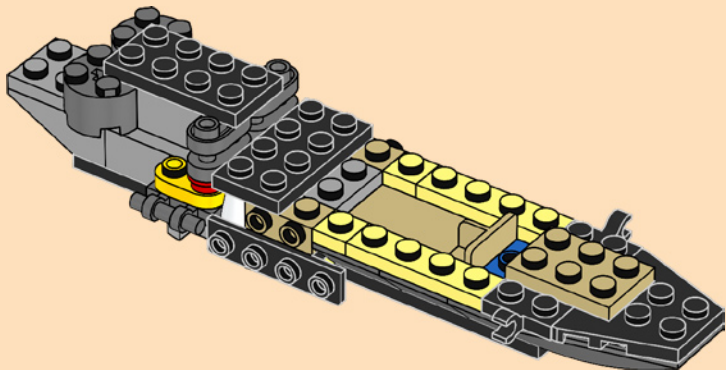

34



25

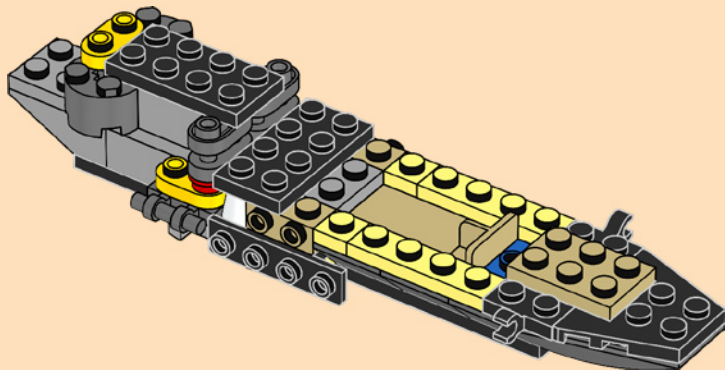

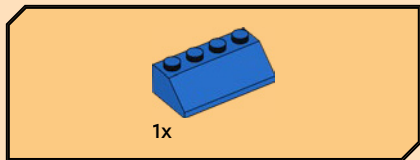

26

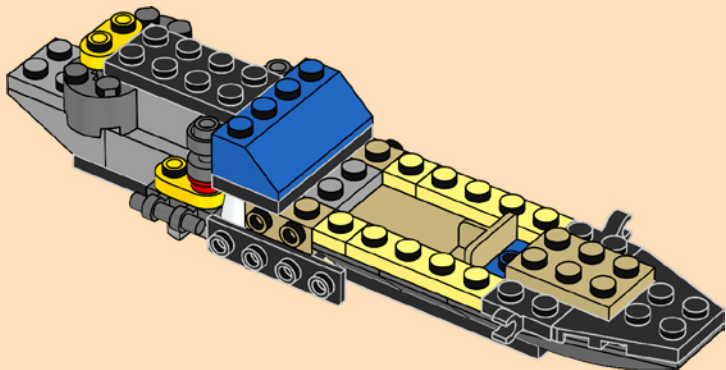



1x

27

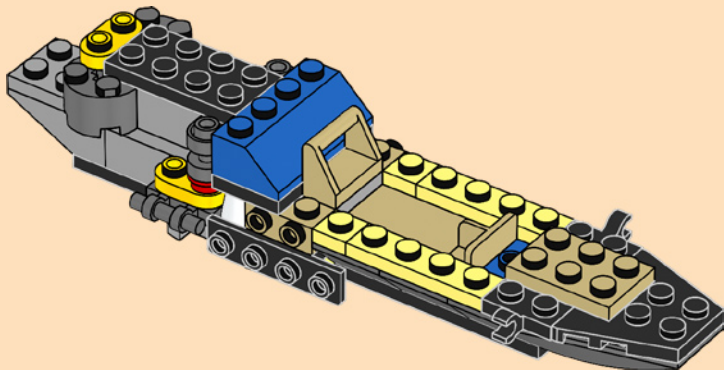

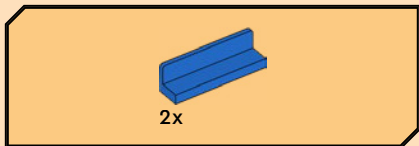

28

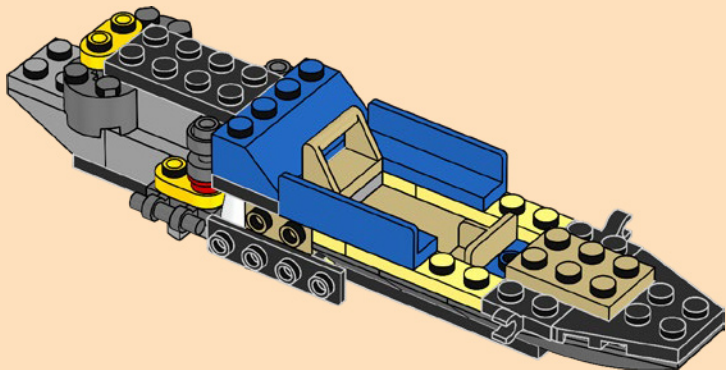

38

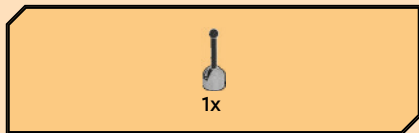

29

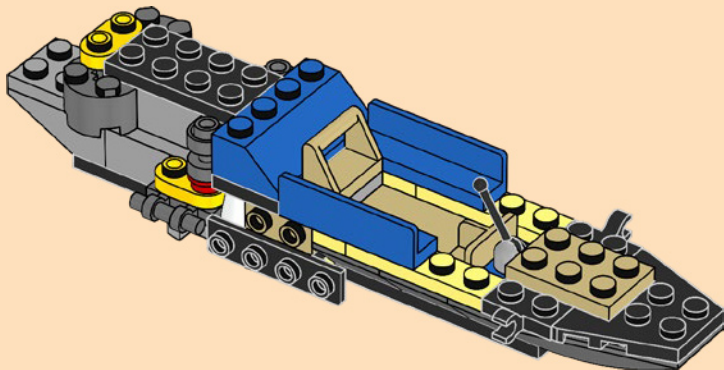



2x

30

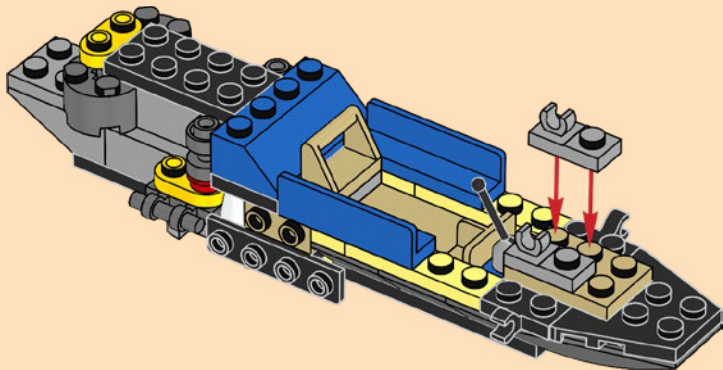

40

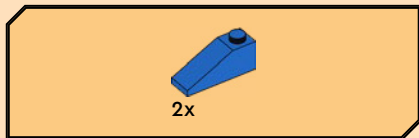

31

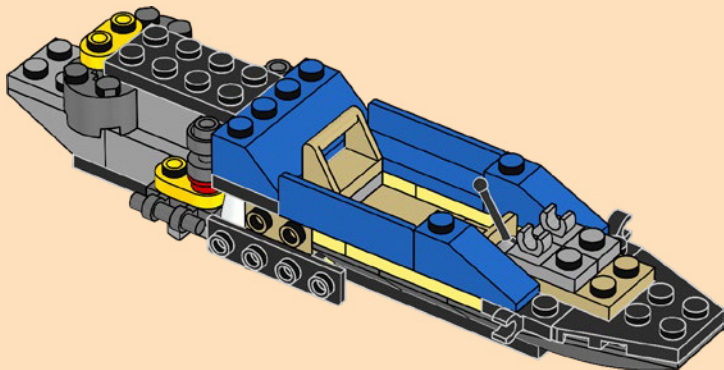



2x

32

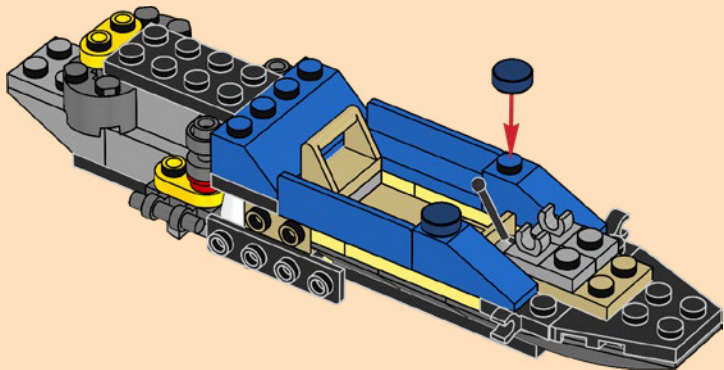

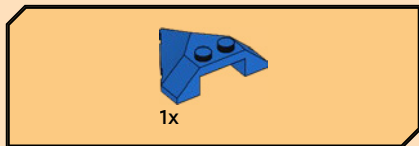

33

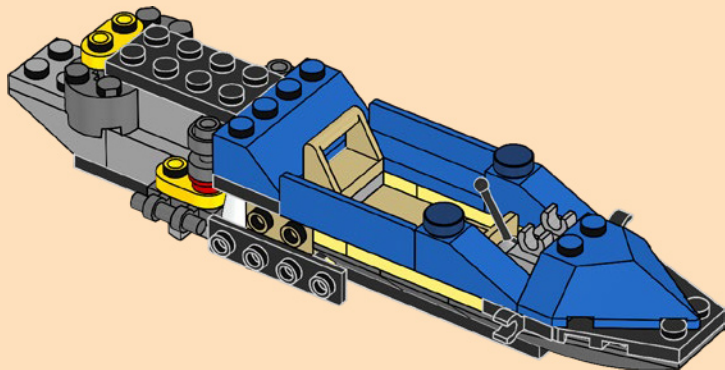



34

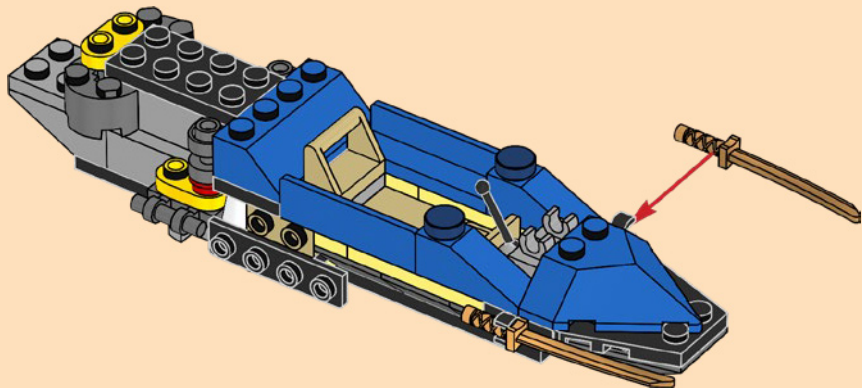



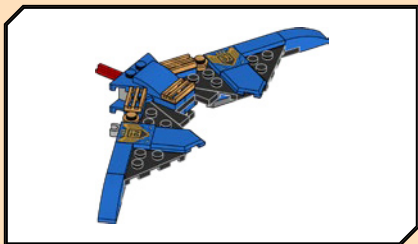

1x



1x

35

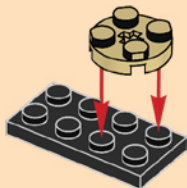

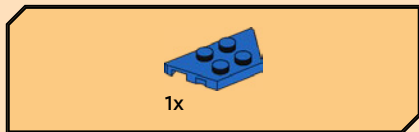

36





1x

37

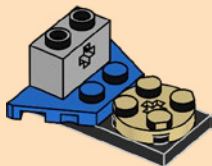

48

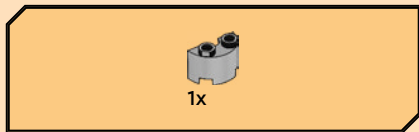

38

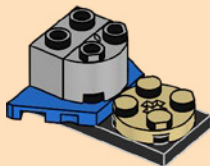

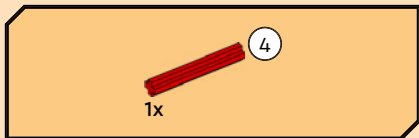

39

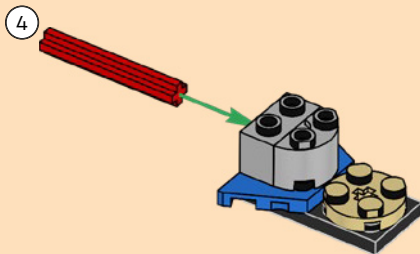

50

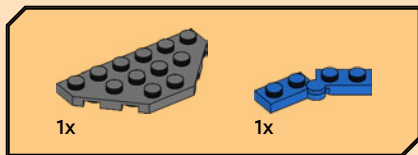
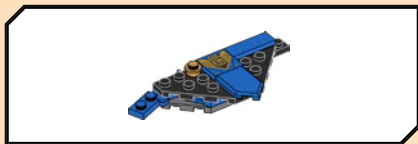

40

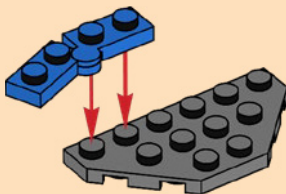



1x



1x

41

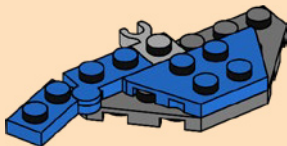

52

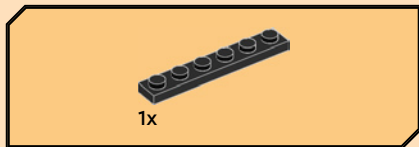

42

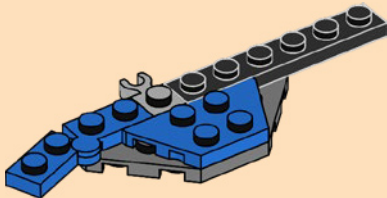

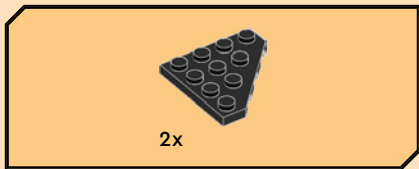

43

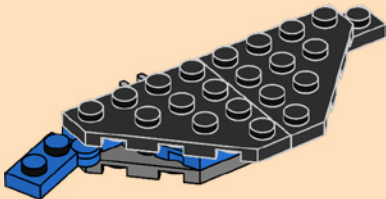

54



1x

44



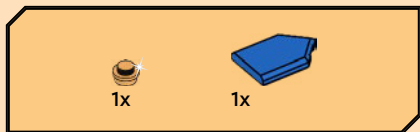

45

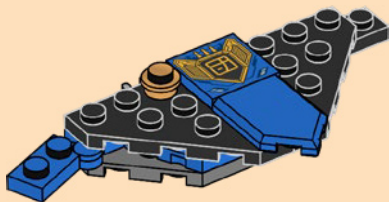

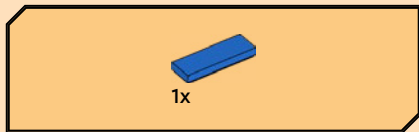

46

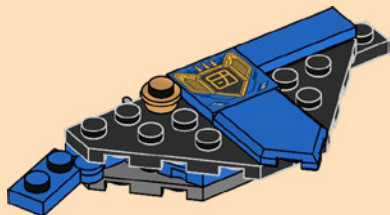

47

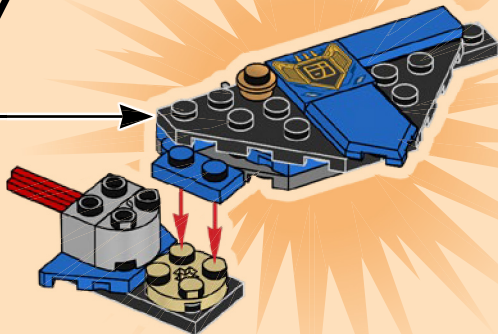

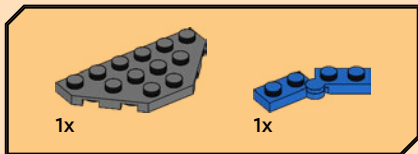

48



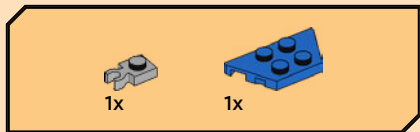

49

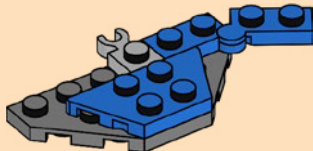

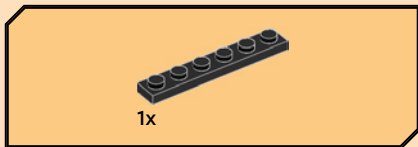

50

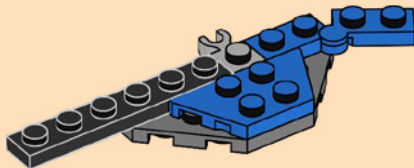

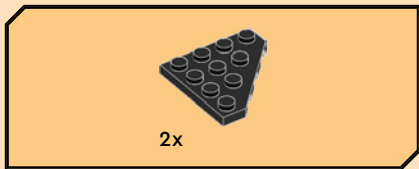

51

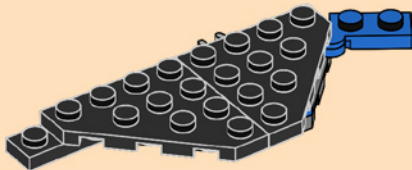

62



1x

52

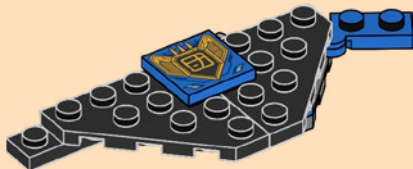

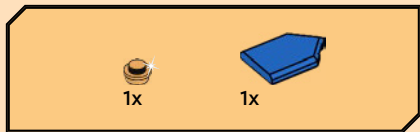

53

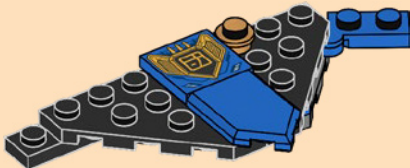

64

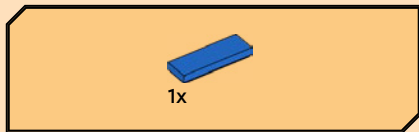

54

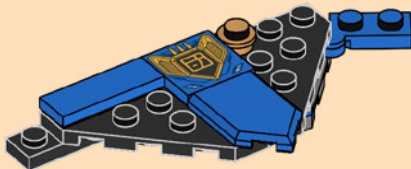

55



66

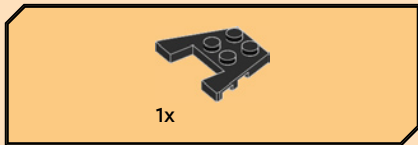

56

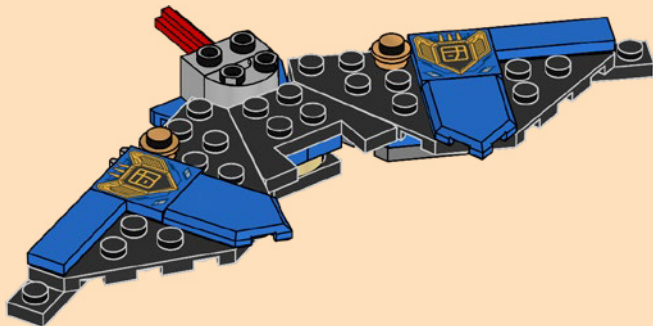

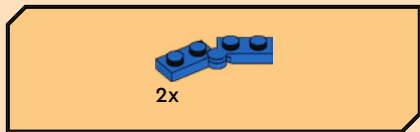

57

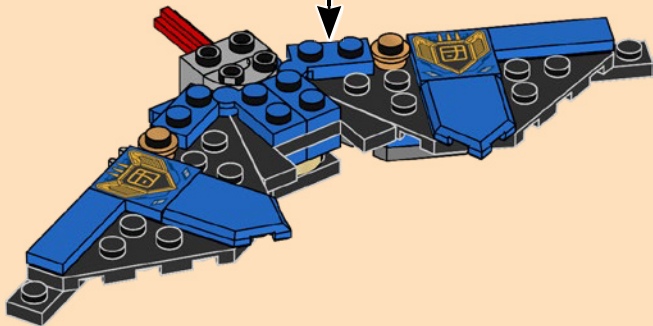
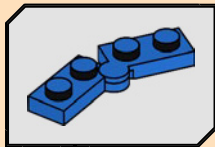

68

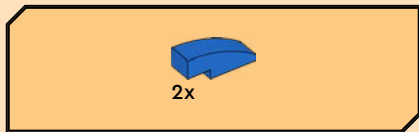

58

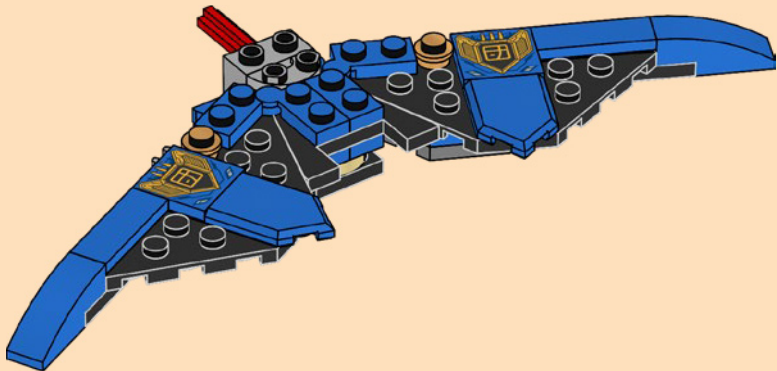



1x

59

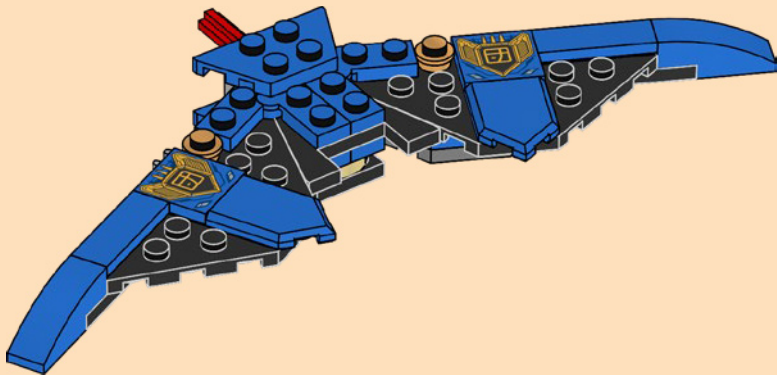

70

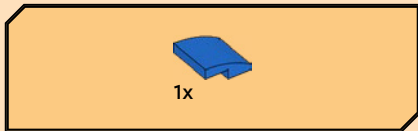

60

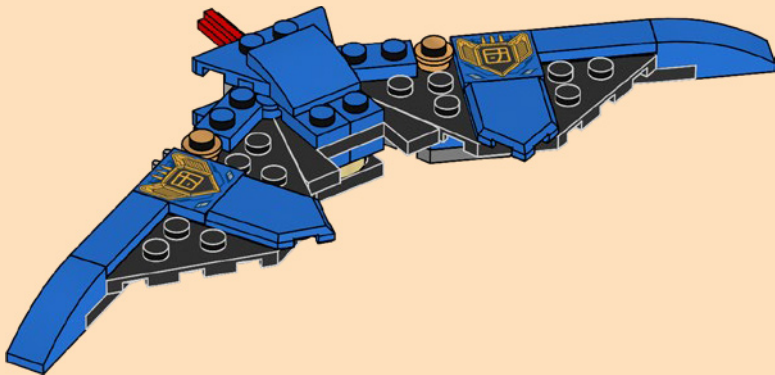

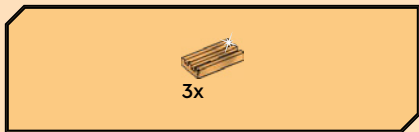

61

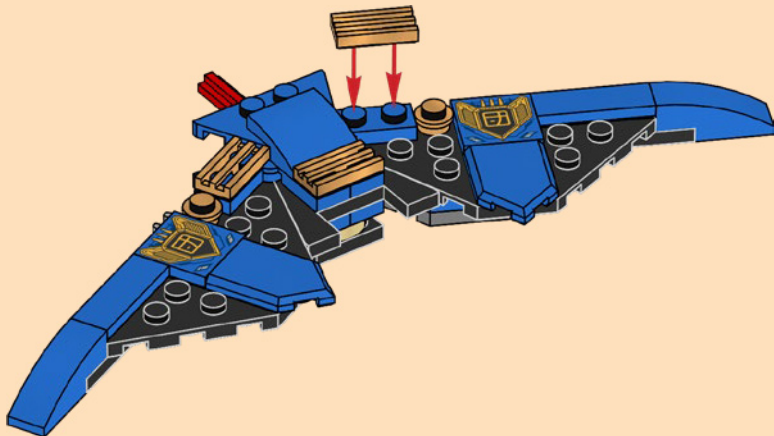

72

62

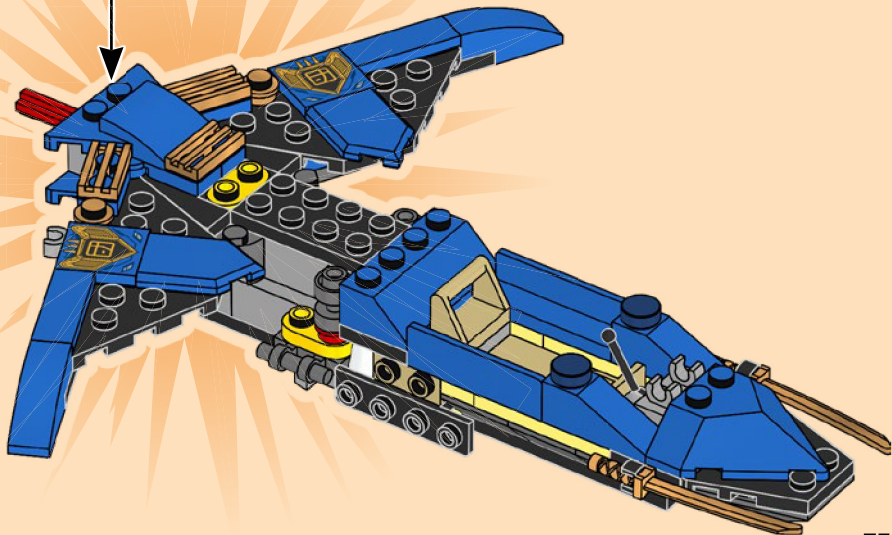

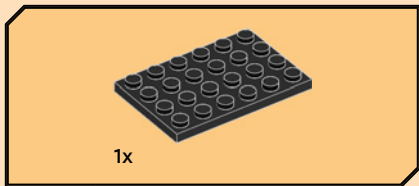

63

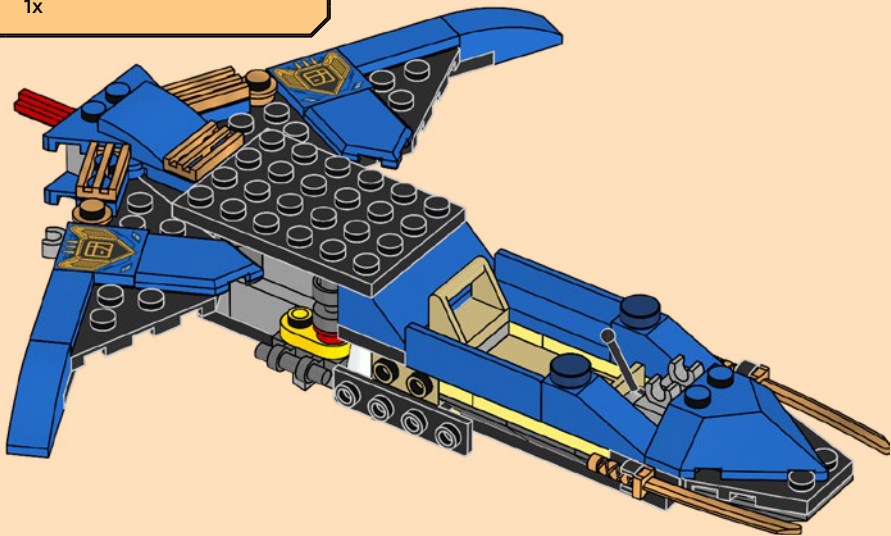



2x



2x

64

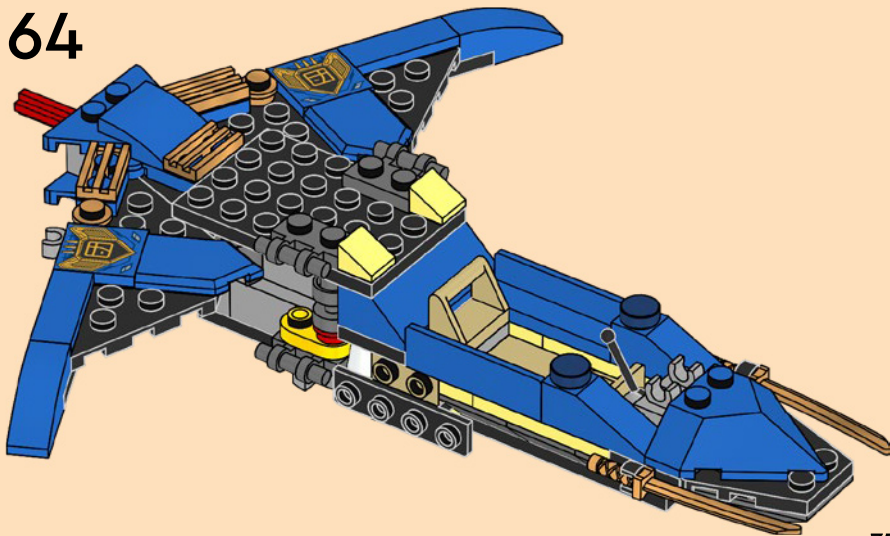

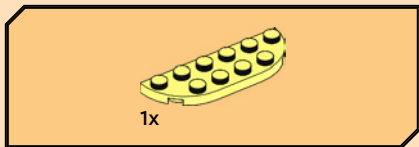

65

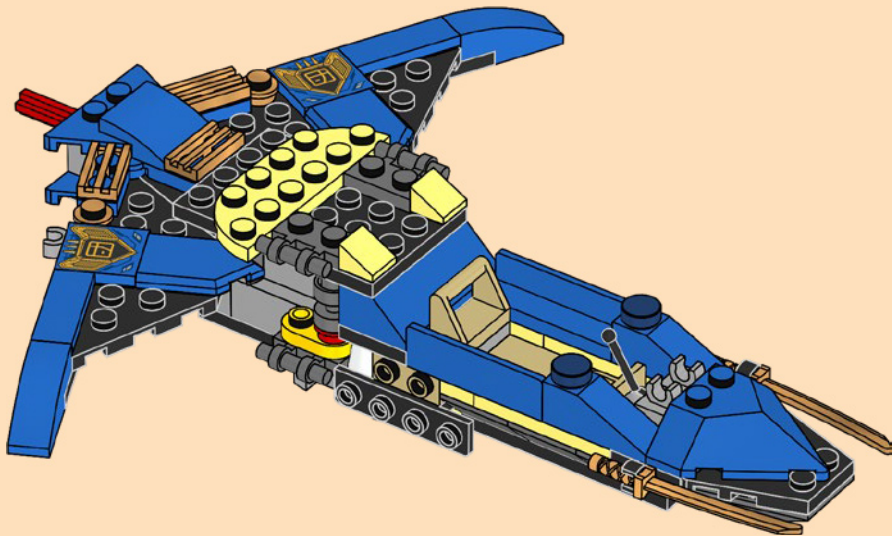

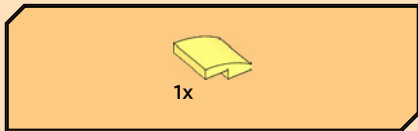

66

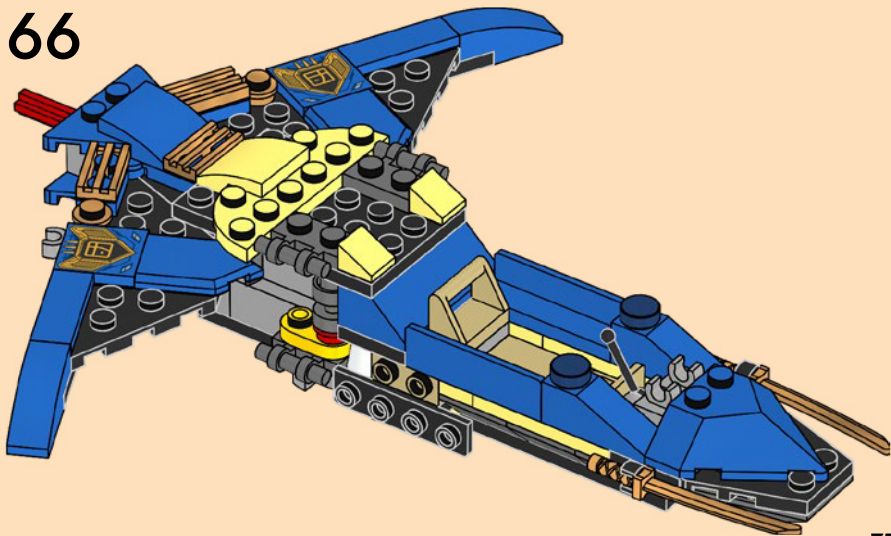

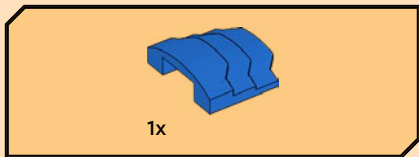

67

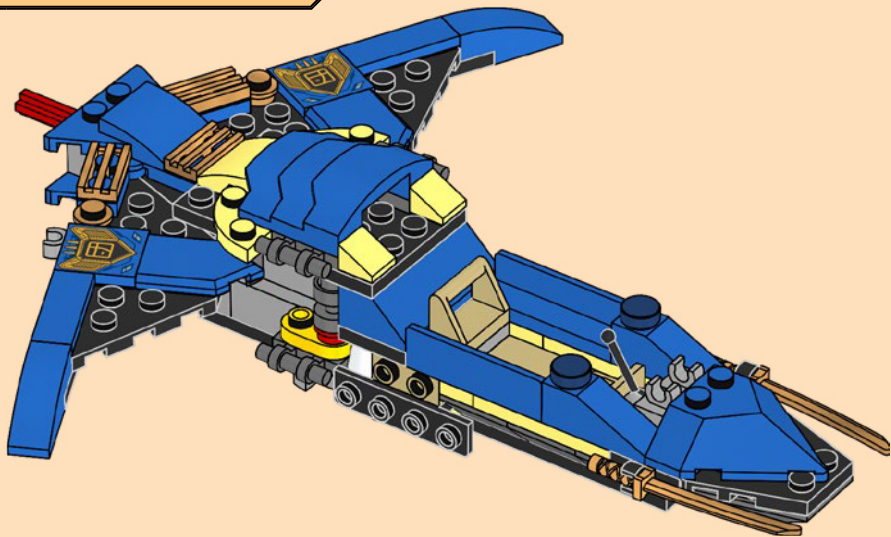

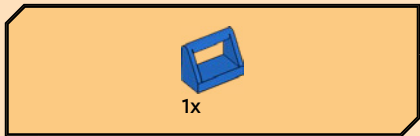

68

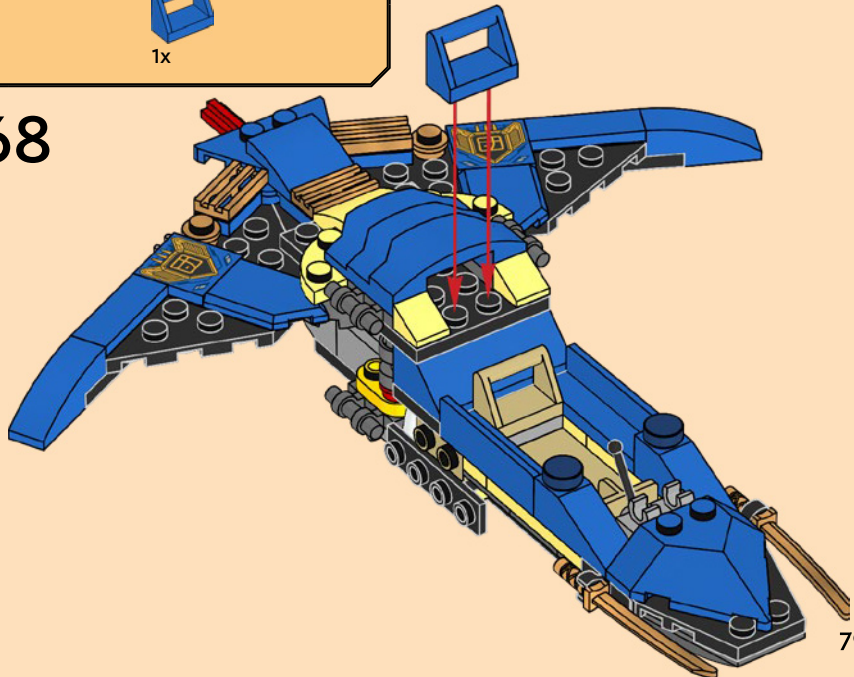

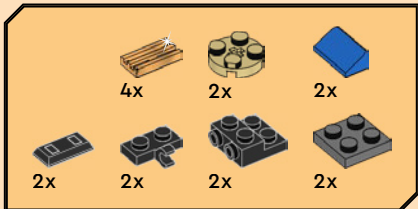

69

1



2



3

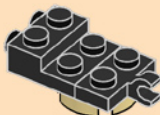

4



5



6

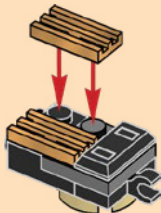

7

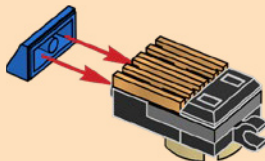

2x

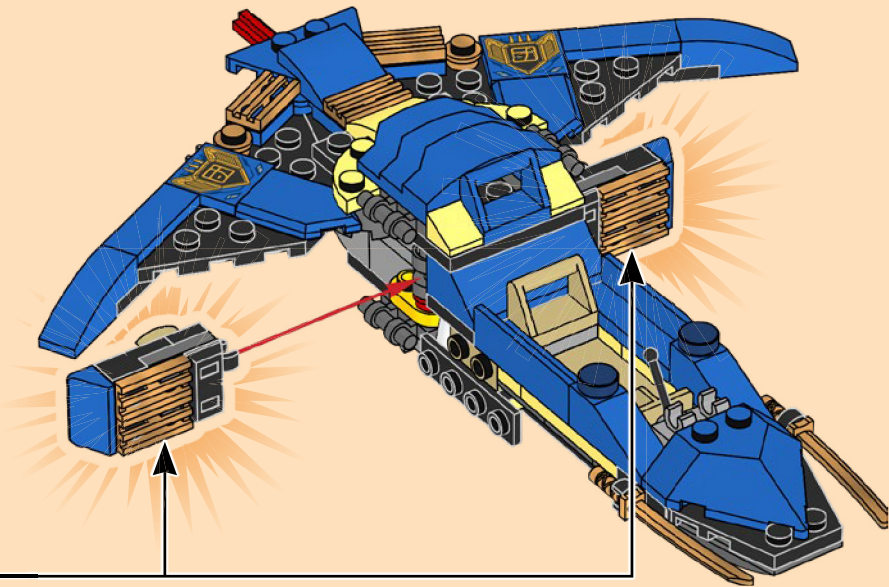

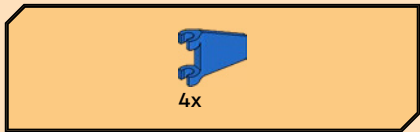

70

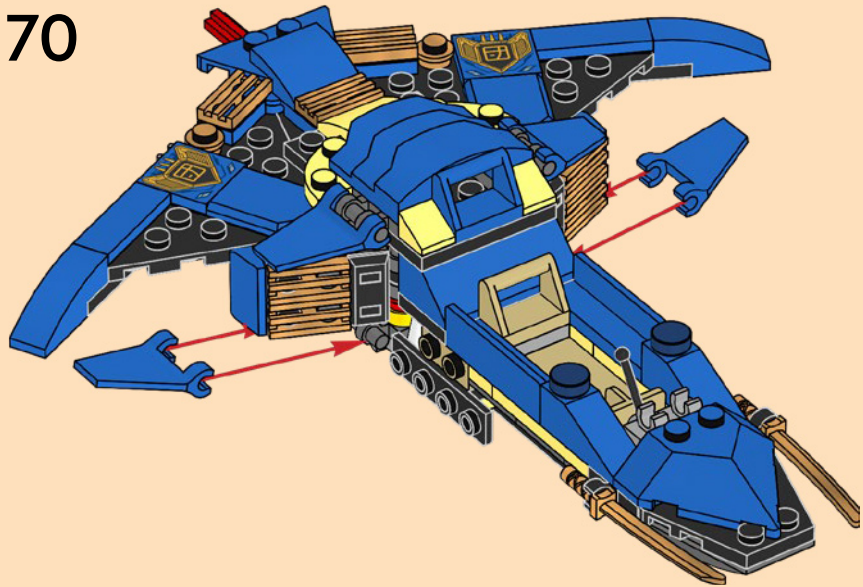

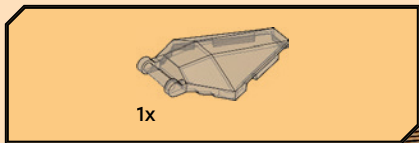

71

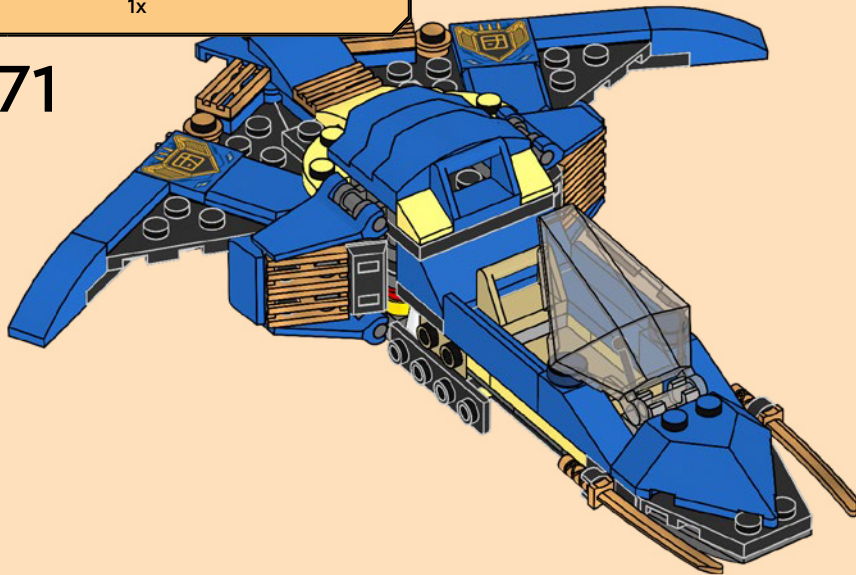

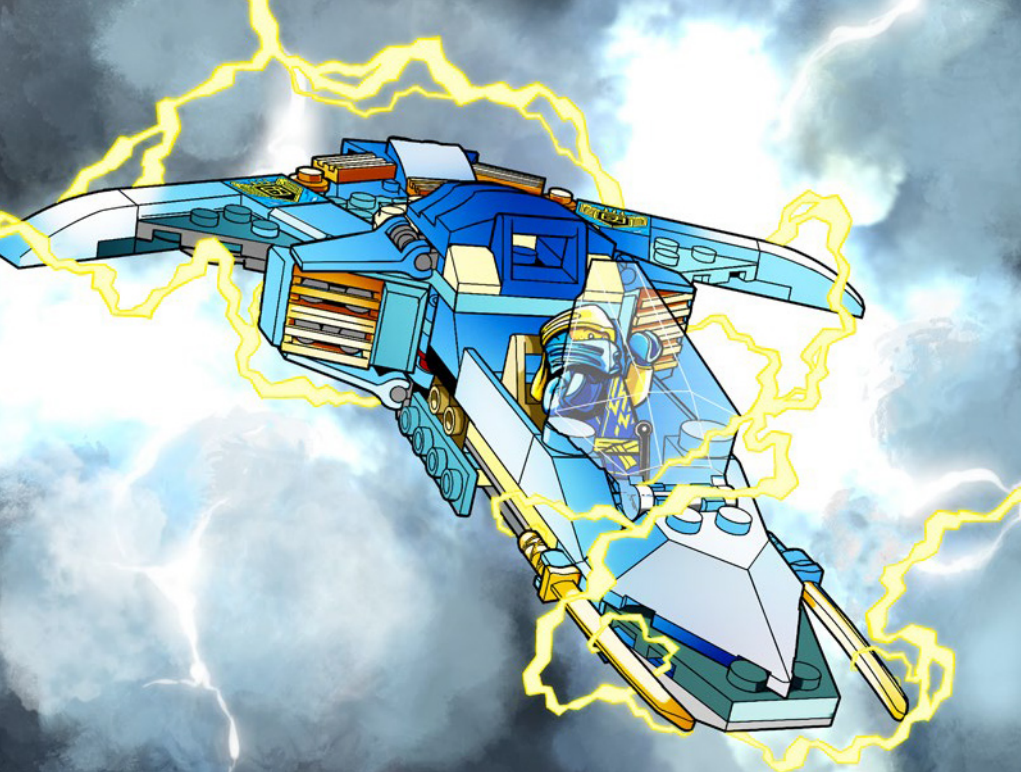





72

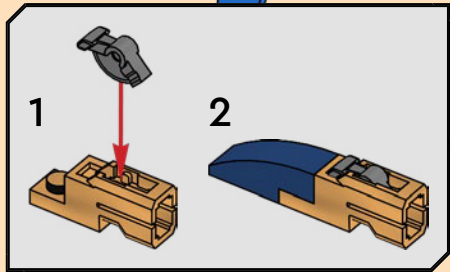
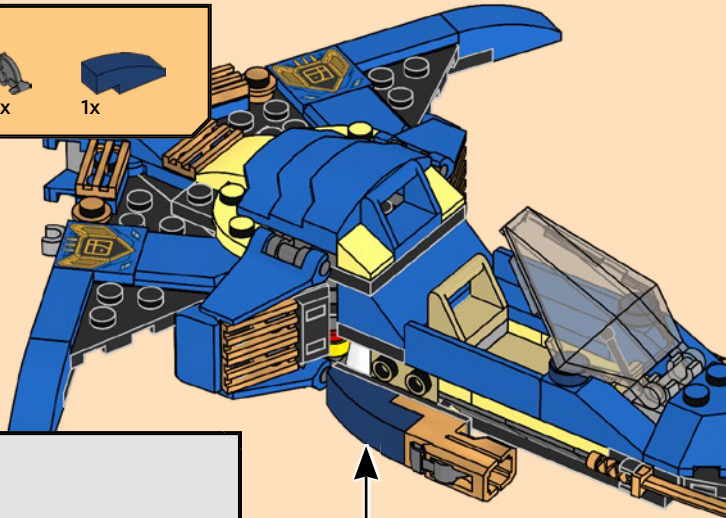

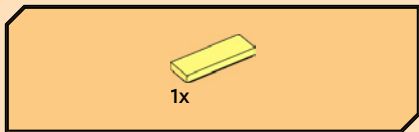

73

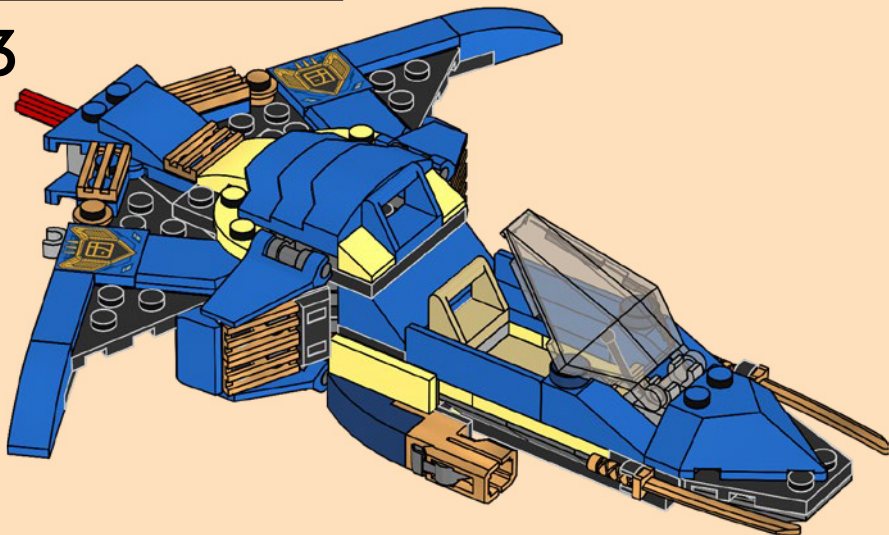



74

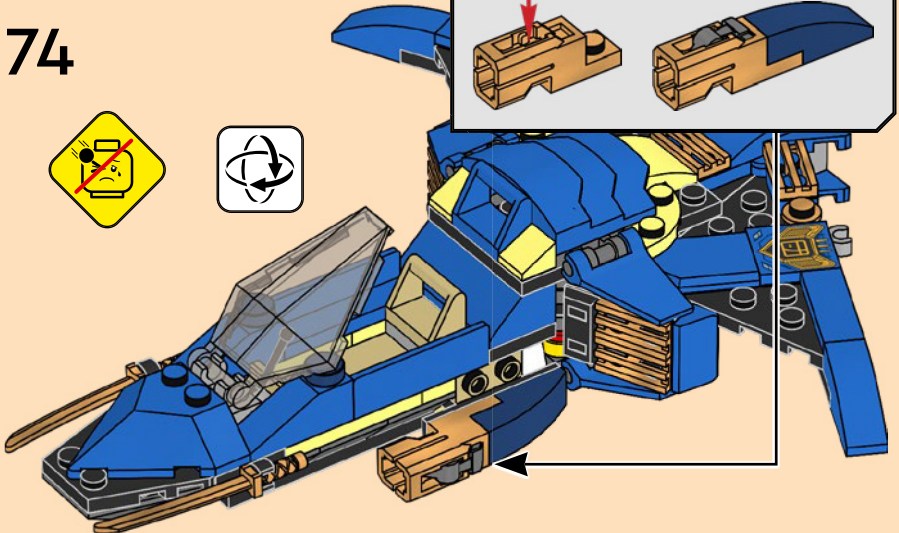
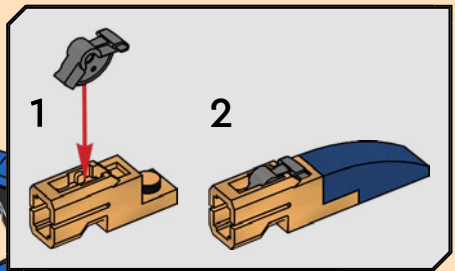

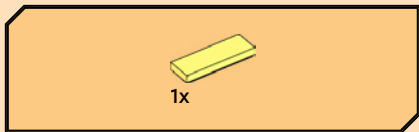

75

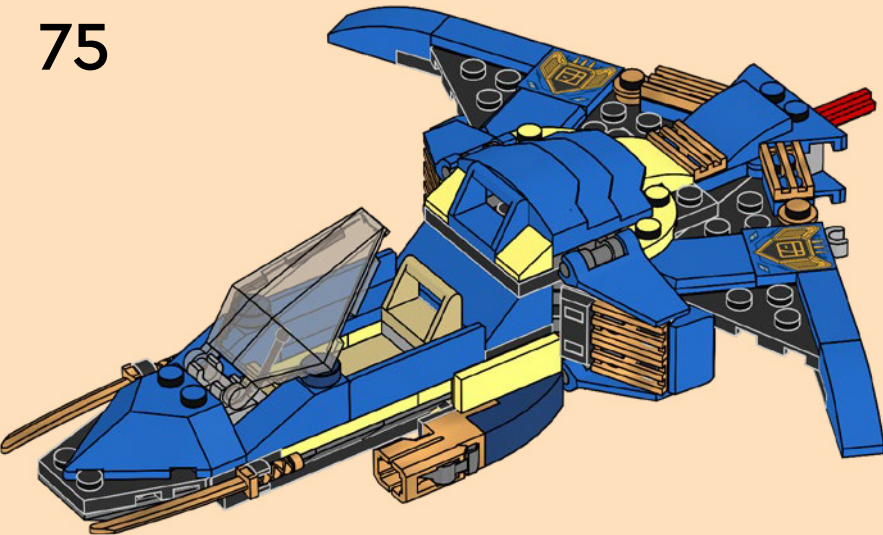

90

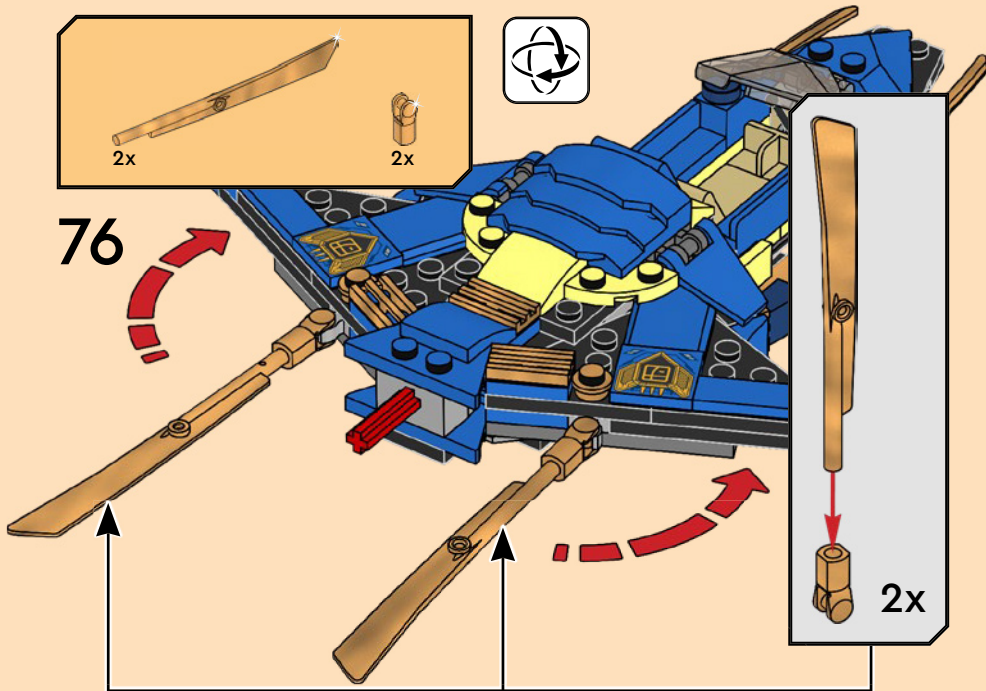

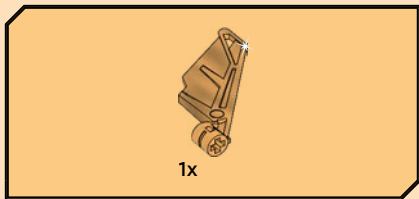

77

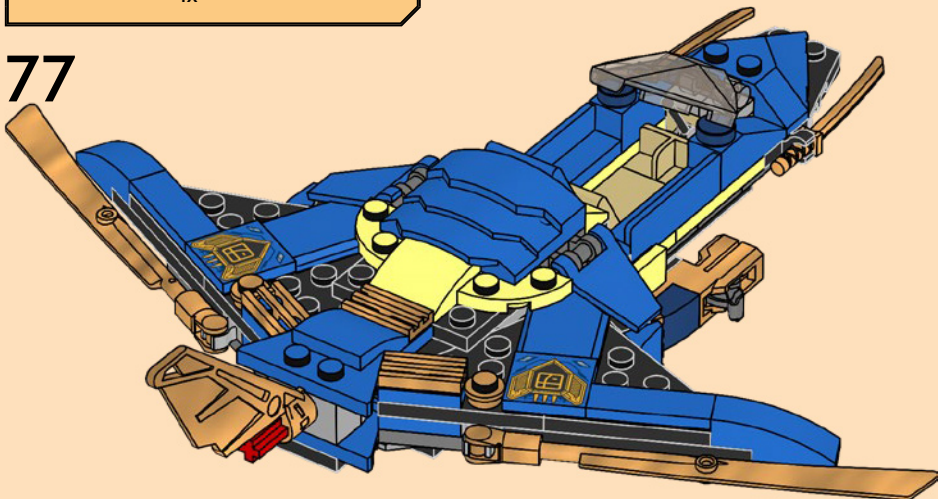



1x

78

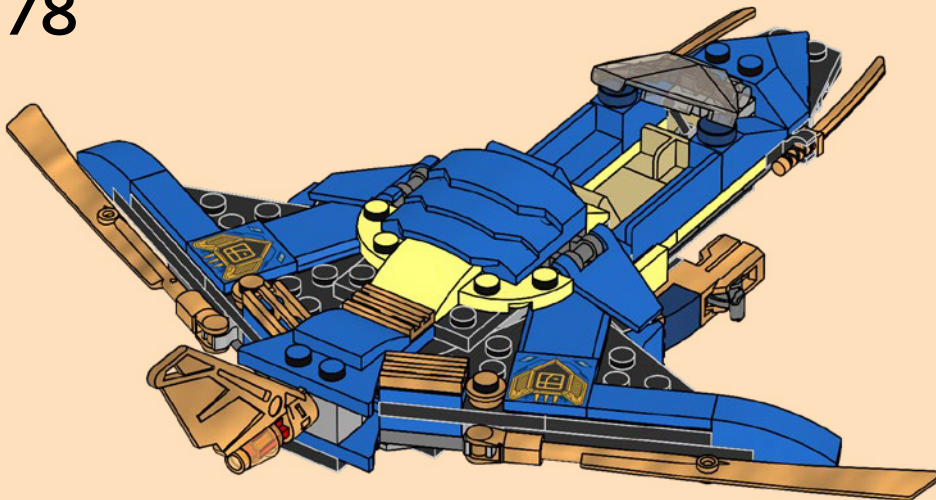



79

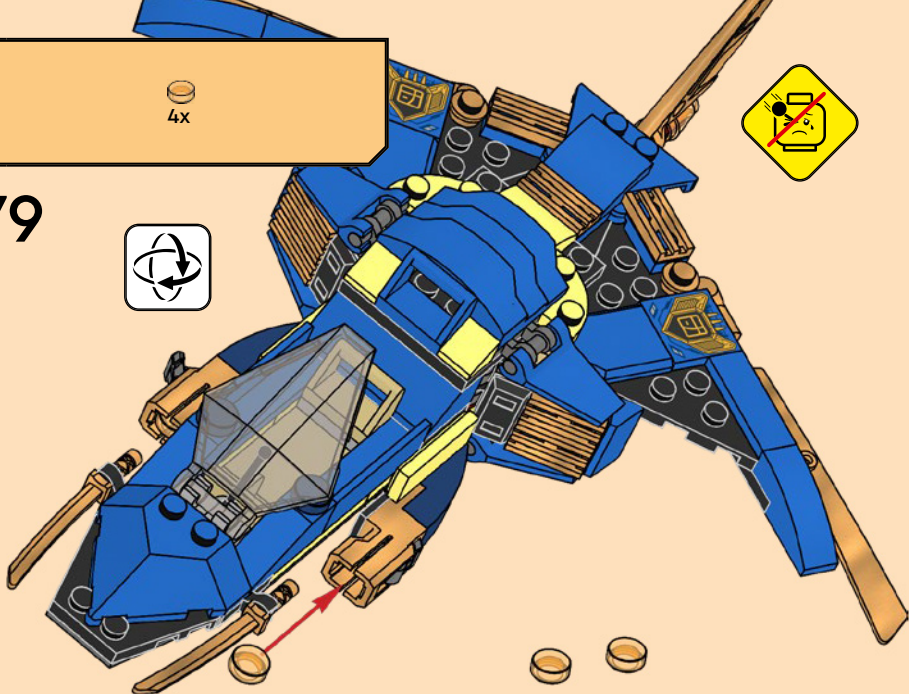



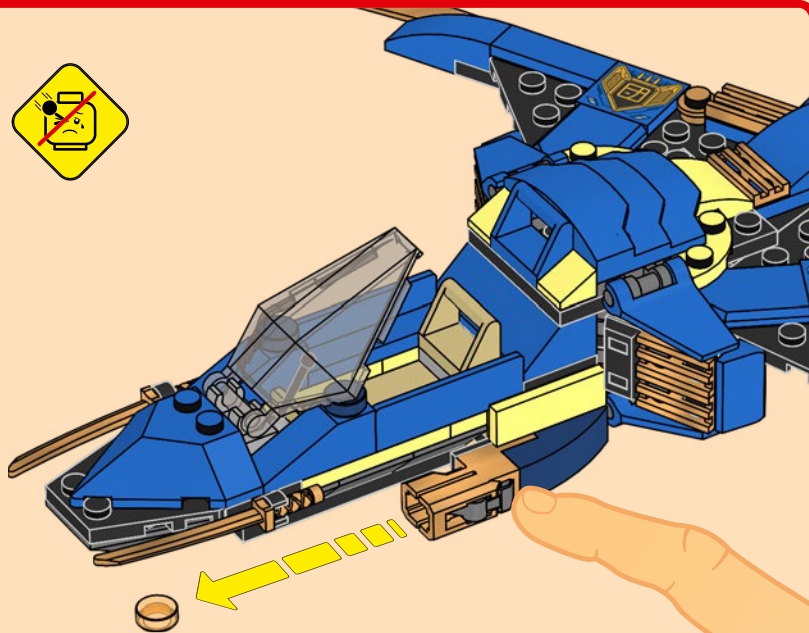

EXPLORE MORE!



Explore more / Mehr entdecken / En savoir plus / Esplora di più /
Explora más / Explora mais / 探索更多 / Узнайте больше /
Zobacz więcej / Objev více / Objav viac / Tudj meg többet! /
Descoperă mai multe / Разгледайте още / Uzzini vairāk /
Uuri lähemalt / Atrask daugiau



Flag illustrations: stockdevil - stock.adobe.com

Flag illustrations / Abgebildete Flaggen / Illustrations de drapeaux / Illustrazioni delle bandiere /
Ilustraciones de banderas / Ilustrações de bandeiras / 旗帜插图 / Иллюстрации флагов /
Ilustracje — flagi / Obrazy vlajek / Obrázky vlajek / Zászló illusztrációk / Ilustrații cu steaguri /
Иллюстрации на знамена / Karogu atteli / Lippude pildid / Vėliavų iliustracijos

Blue-Ocean-AG.com/LEGONinjagoMagazine



4x
4140562



1x
6021208



1x
6153157



2x
6132769



1x
4159739



1x
6175367



2x
614121



1x
6129995

98

4



1x
6371747



2x
4651236



1x
243223



1x
6092582



4x
6424609



1x
6116786



2x
6421055



1x
6371741



2x
428623



2x
4587840



2x
4543998



2x
6245248



4x
4609454



2x
6146957



1x
6424606



4x
6416505



1x
4107437

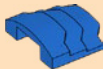

1x
6421594



1x
6172233



4x
6274747



1x
6341749



2x
6284584



2x
4540280



2x
6360675



2x
6390673



2x
4249139



4x
4210660



2x
4211094



2x
4211076



2x
4210984



1x
4636417



1x
4221775



1x
6311384



2x
6296894



2x
6326078



1x
6206249



2x
4211387



1x
6435930

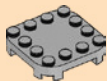

1x
6294703

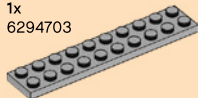

1x
4211462



2x
4518400

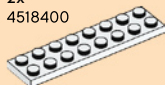

1x
303401



2x
366626

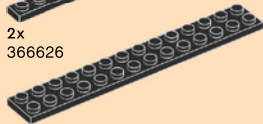

1x
6001494



1x
303226



4x
6313116



2x
6156991



2x
6052126



2x
6168620



4x
4160025



2x
6170529



3x
302026



1x
6377827



2x
6058014



1x
6296487



2x
6195265



3x
6248756



1x
6147709



2x
6296498



1x
6191858



3x
6248971



2x
6296657



2x
4523159



2x
6345949



2x
6116596



2x
6270131



1x
6213766



7x
4490599



[LEGO.com/service](https://www.LEGO.com/service)

YOU COULD

WIN



Scan this QR code or go to
LEGO.COM/PRODUCTFEEDBACK and give us
your short feedback about this LEGO® set
for a chance to win a cool LEGO prize.

Terms and Conditions apply*

DE: Du könntest GEWINNEN. Es gelten die Teilnahmebedingungen* **FR: Tu pourrais GAGNER.** Des conditions s'appliquent* **IT: Potresti VINCERE tu.** Termini e condizioni sono applicabili* **ES: Puedes GANAR.** Aplican términos y condiciones* **PT: Poderá GANHAR.** Aplicam-se termos e condições* **JA: プレゼント付き! 利用規約が適用されます*** **ZH: 轻松获奖. 条款和条件适用*** **KO: 상품의 주인이 되어보세요. 소정의 약관이 적용됩니다*** **RU: Вы можете ВЫИГРАТЬ.** Действуют положения и условия* **PL: Szansa na WYGRANĄ.** Obowiązują warunki korzystania* **CS: Máte šanci VYHRÁT.** Platí všeobecné smluvní podmínky* **SK: Máte šancu VYHRÁŤ.** Platia všeobecné zmluvné podmienky* **HU: TE IS NYERHETSZ.** Felhasználási feltételek érvényesek* **RO: Ai putea CÂȘTIGA.** Se aplică termenii și condiții* **BG: Можете да СПЕЧЕЛИТЕ.** Има определени правила и условия* **LV: Tu vari LAIMĒT.** Ir spēkā noteikumi un nosacījumi.* **ET: Sul on võimalus VÕITA.** Kehtivad tingimused* **LT: Jūs galite LAIMĖTI.** Taikomos sąlygos*

*[LEGO.com/productfeedback-terms](https://www.lego.com/productfeedback-terms)