

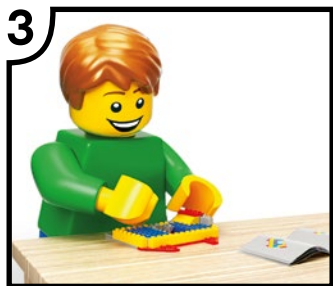

# CLASSIC

11013







- 1** Scan the code on the front cover  
Scanne den Code auf der Titelseite  
Scanne le code sur la page de couverture  
Scanner le code sur la page couverture  
Scansiona il codice sulla copertina  
Escanea el código de la portada  
Faz scan do código na frente da capa  
Olvasd be a borítón látható kódot!  
Noskenë kodu uz priekšējā vāka  
扫描封面上的二维码



- 2** Get Instructions PLUS  
Hol dir Instructions PLUS  
Obtiens les instructions PLUS  
Obtenir les Instructions PLUS  
Scarica Instructions PLUS  
Descubre Instructions PLUS  
Obtém Instruções PLUS  
Szerezd be az Instructions PLUS kiegészítőt!  
Sanjem "Instructions PLUS"  
获取更多说明

**LEGO.com/apps**

Check for compatibility  
Kompatibilität prüfen  
Vérifier la compatibilité  
Controlla la compatibilità  
Comprueba tu compatibilidad

Verificar a compatibilidade  
Ellenőrizd a kompatibilitást  
Pārbaudīt saderību  
检查兼容性

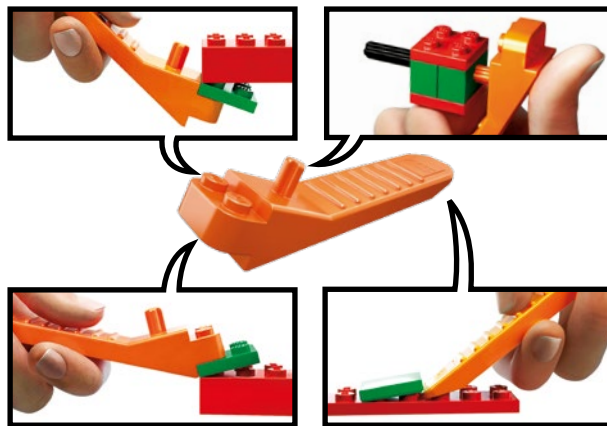

[LEGO.com/brickseparator](https://LEGO.com/brickseparator)



Page  
**6**



Page  
**21**



Page  
**41**



Page  
**11**



Page  
**29**



Page  
**52**

Page  
Seite  
Pagina  
Página  
Oldalszám  
Lpp.  
页码

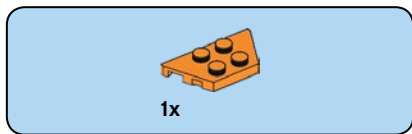
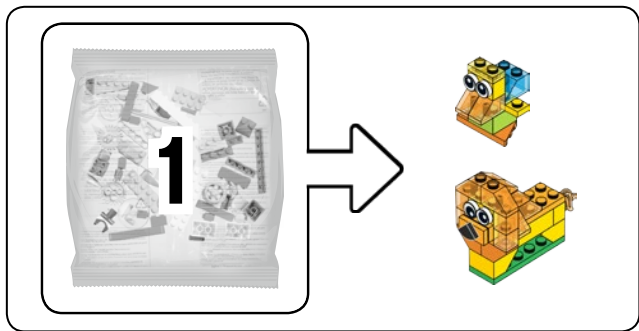

1

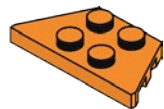

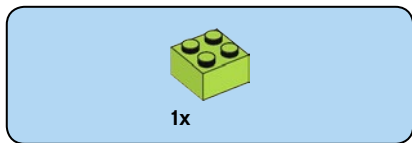

**2**

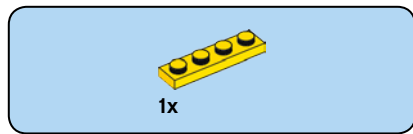
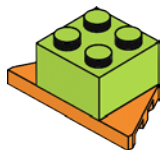

**3**

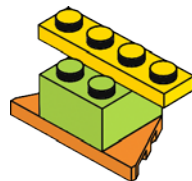

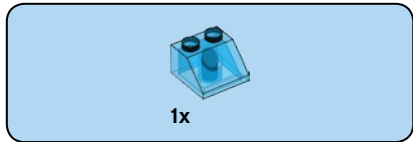

4

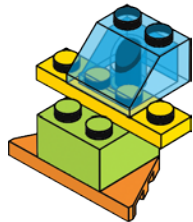





5

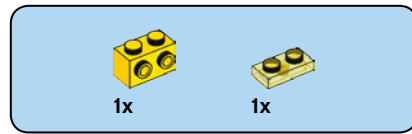
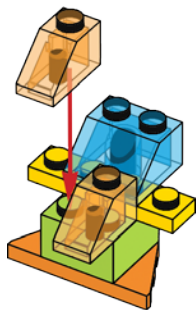

6

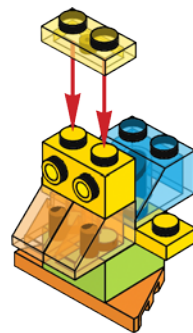



2x

7



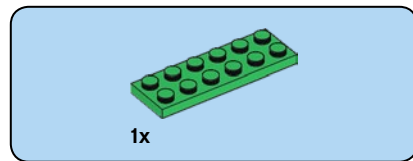

1

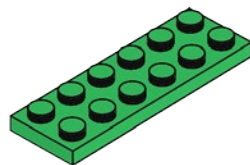



2x

2

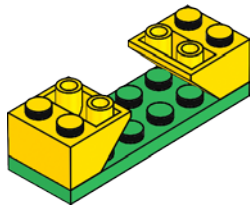

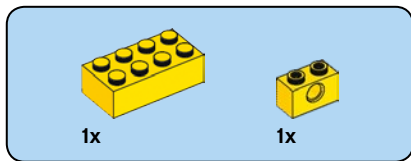

3

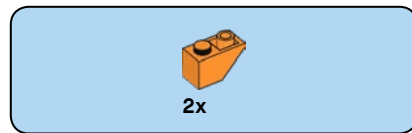
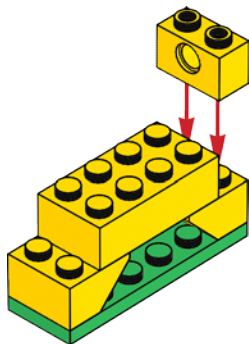

4

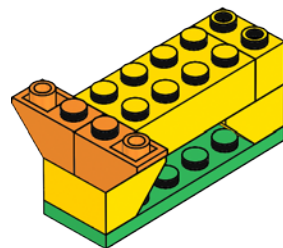

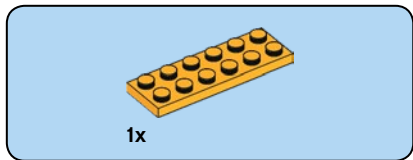

5

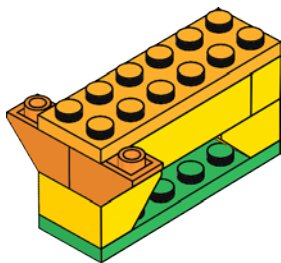



1x

6

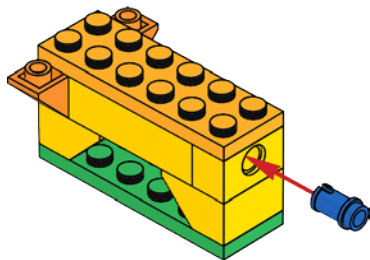

1x



1x

7

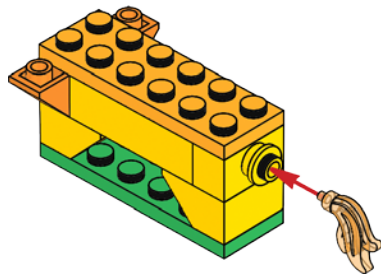



2x



2x

8

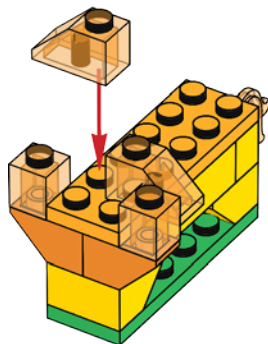





9

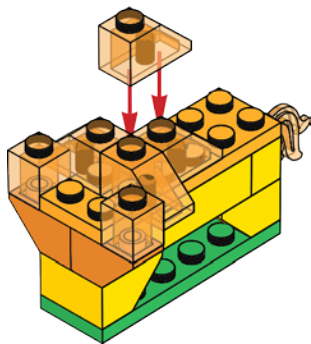

10

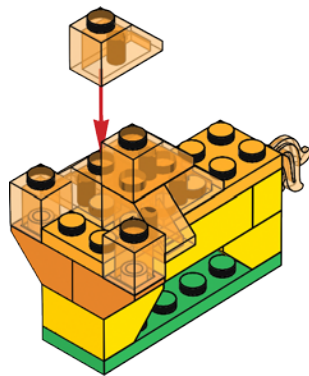

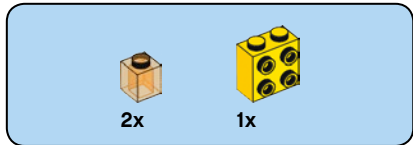

11

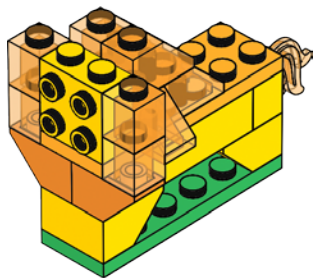



12

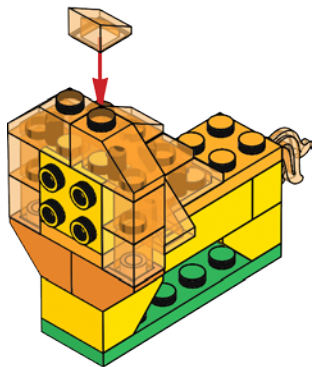

13

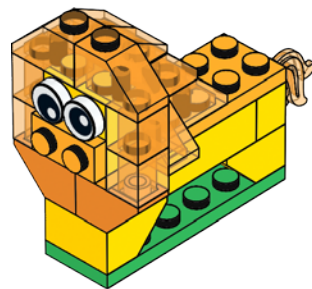



1x



1x

14

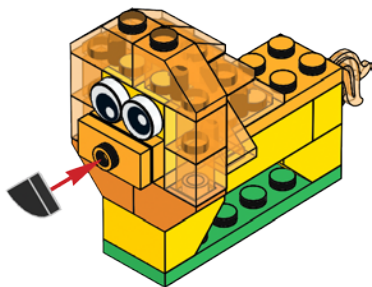

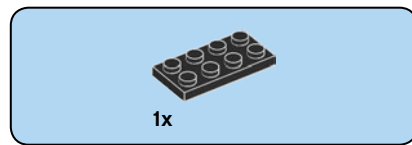
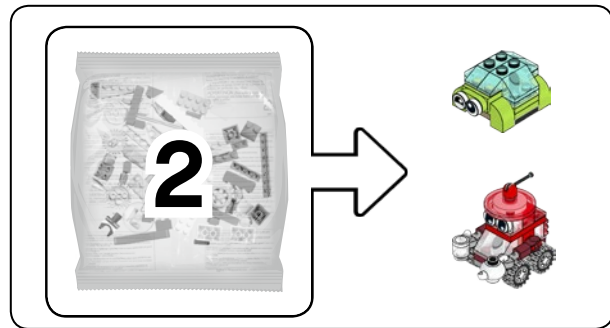

1

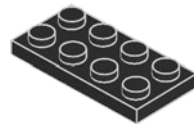



1x

**2**

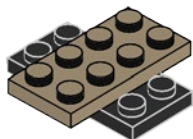



2x

3

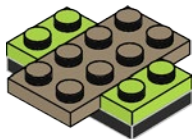

1x

4

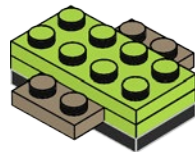



4x

5

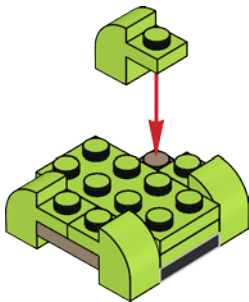



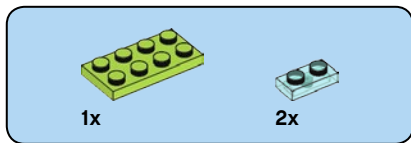

6

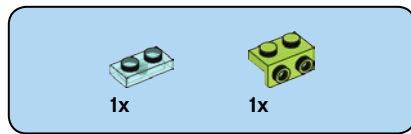
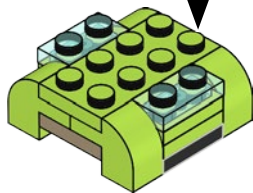
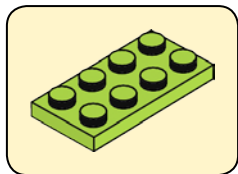

7

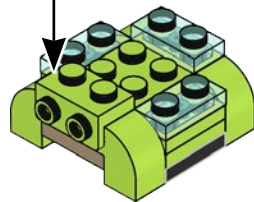
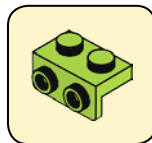



2x

8

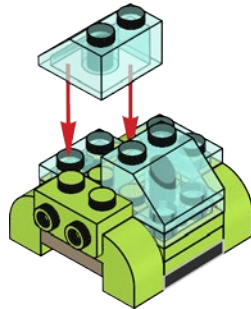



4x

9

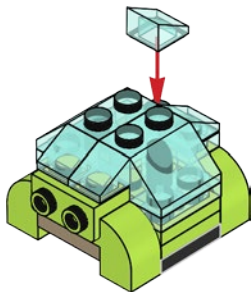

1x

10

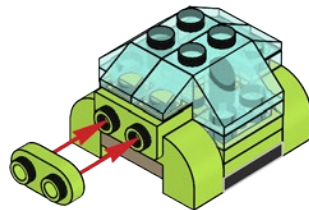



1x



1x

11





1x

1

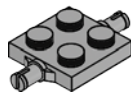



1x

2





1x

3

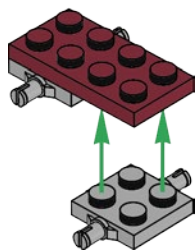

2x

4

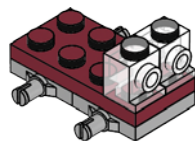



1x

5







2x

6

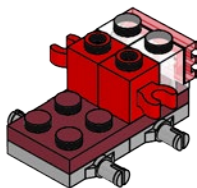

1x

7





1x

8





2x

9

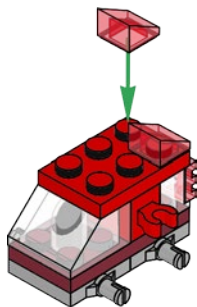

2x



1x

10





1x



2x

11



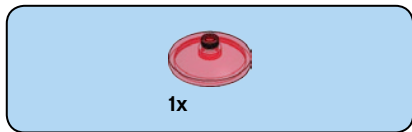

12

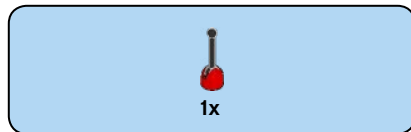

13





4x



4x

# 14

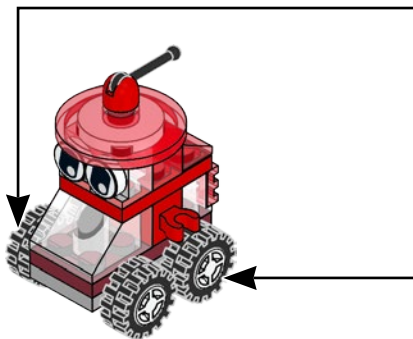
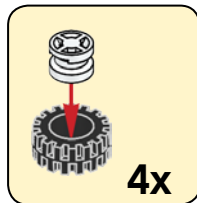



1x



1x



1x

# 15

1

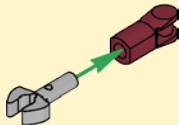

2

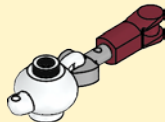



1x



1x



1x

# 16

1

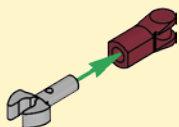

2

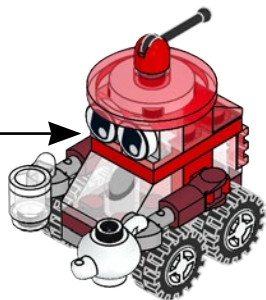



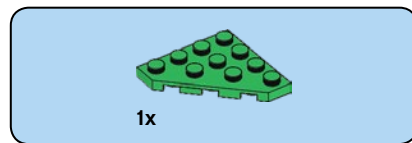
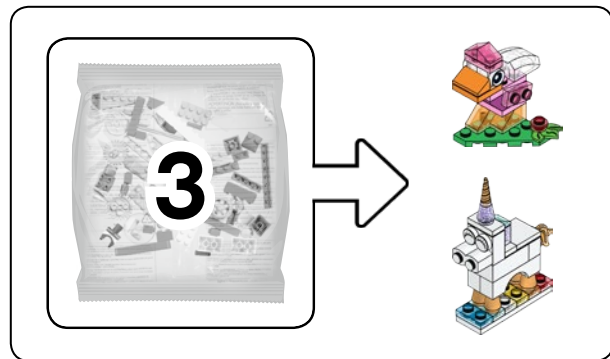

1

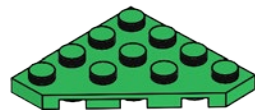



1x



1x

2

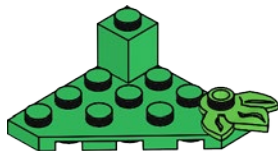

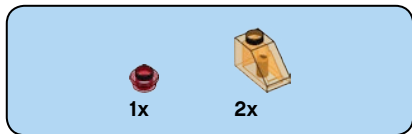

3

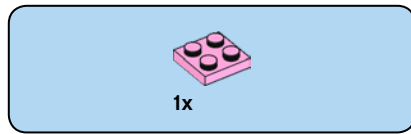
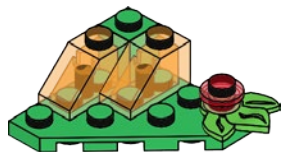

4

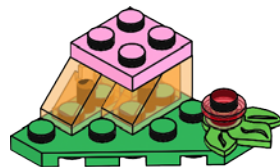



2x

5

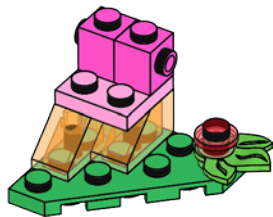

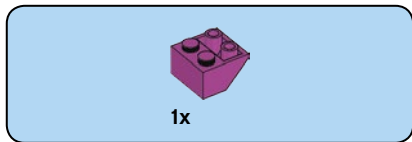

6

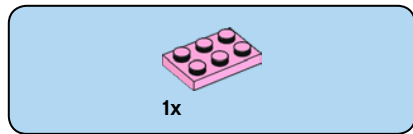
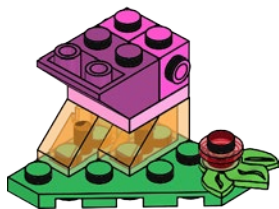

7

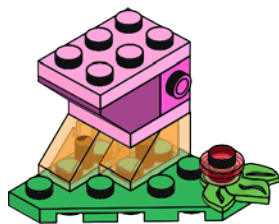



2x

8

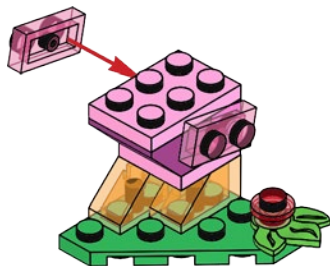



1x

9





1x

10

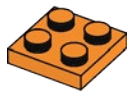





2x

11

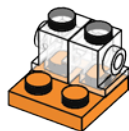

1x



1x

12

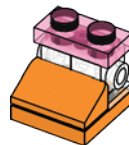



2x

13

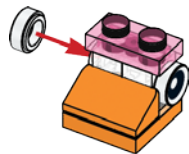

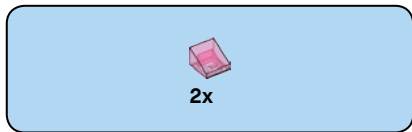

14



15

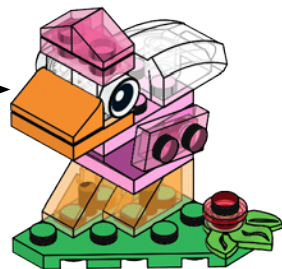

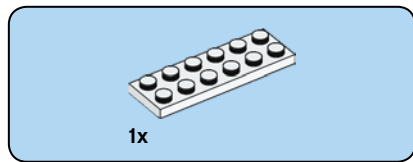

1

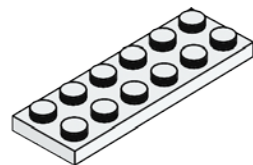

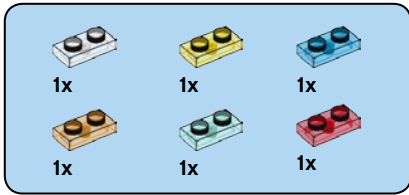

2

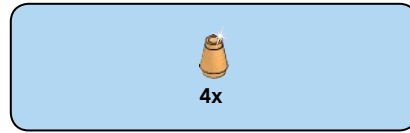
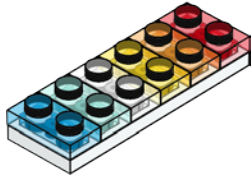

3

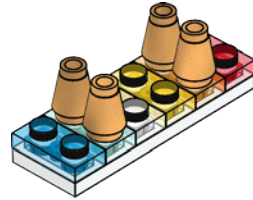



2x

4

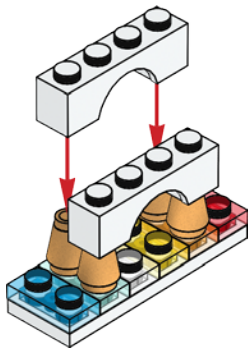

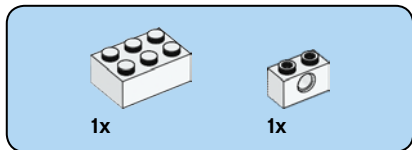

5

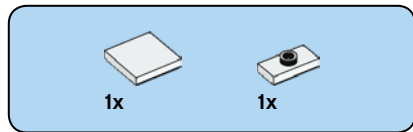
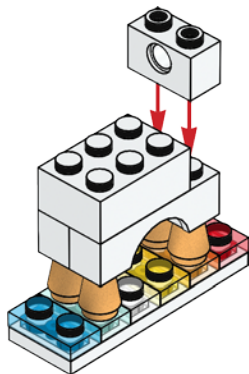

6

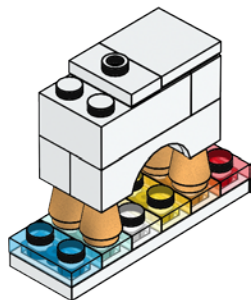



1x

7

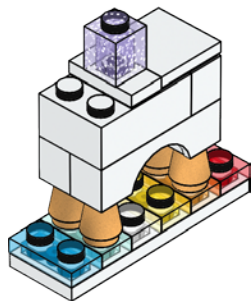





1x



1x

8

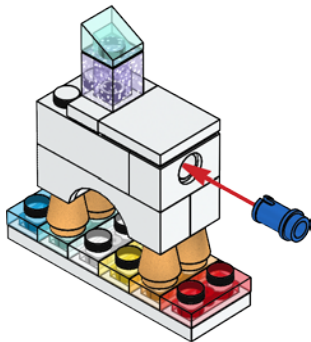

1x



1x

9

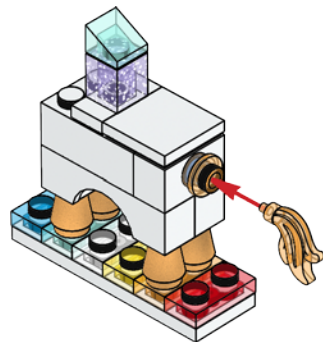

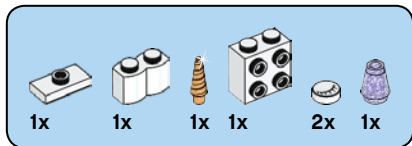

10

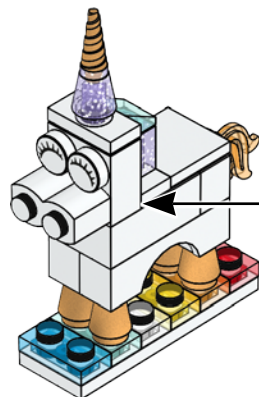
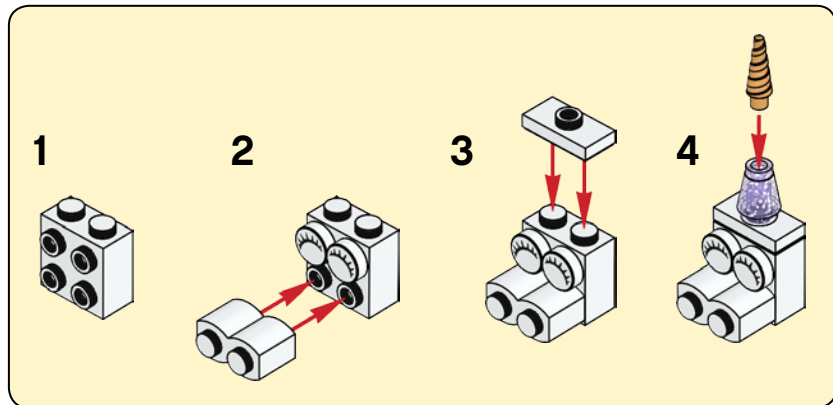



# CLASSIC



What fun things can you build?  
Welche lustigen Sachen kannst du bauen?  
Quels objets amusants peux-tu construire ?  
Quali cose divertenti sai costruire?  
¿Qué cosas divertidas puedes construir?  
Que coisas divertidas consegues construir?  
Milyen mókás dolgokat tudsz megépíteni?  
Kādas interesantas lietas tu uzbūvēsi?  
你能拼搭出什么有趣的模型呢？





# CLASSIC



10698



10696



10713



11014



11010



10700



10714



10701

 [LEGO.com/classic](https://www.lego.com/classic)

