



Architecture

21042

Statue of Liberty

New York, USA



Booklet available in English on
Heft in deutscher Sprache erhältlich auf
Livret disponible en français sur
Libretto disponibile in italiano su
Folleto disponible en español en
Folheto disponível em português em
A füzet magyarul ezen a honlapon olvasható:
Buklets latviešu valodā pieejams vietnē
如需中文版手册, 请访问



[LEGO.com/architecture/booklet](https://www.lego.com/architecture/booklet)

Liberty

The Statue of Liberty was a gift of friendship from the people of France to the United States, and has since become a universal symbol of freedom and democracy throughout the world. Dedicated on the 28th of October 1886, she was often the first thing people saw as they sailed into New York's harbor to start a new life in America.

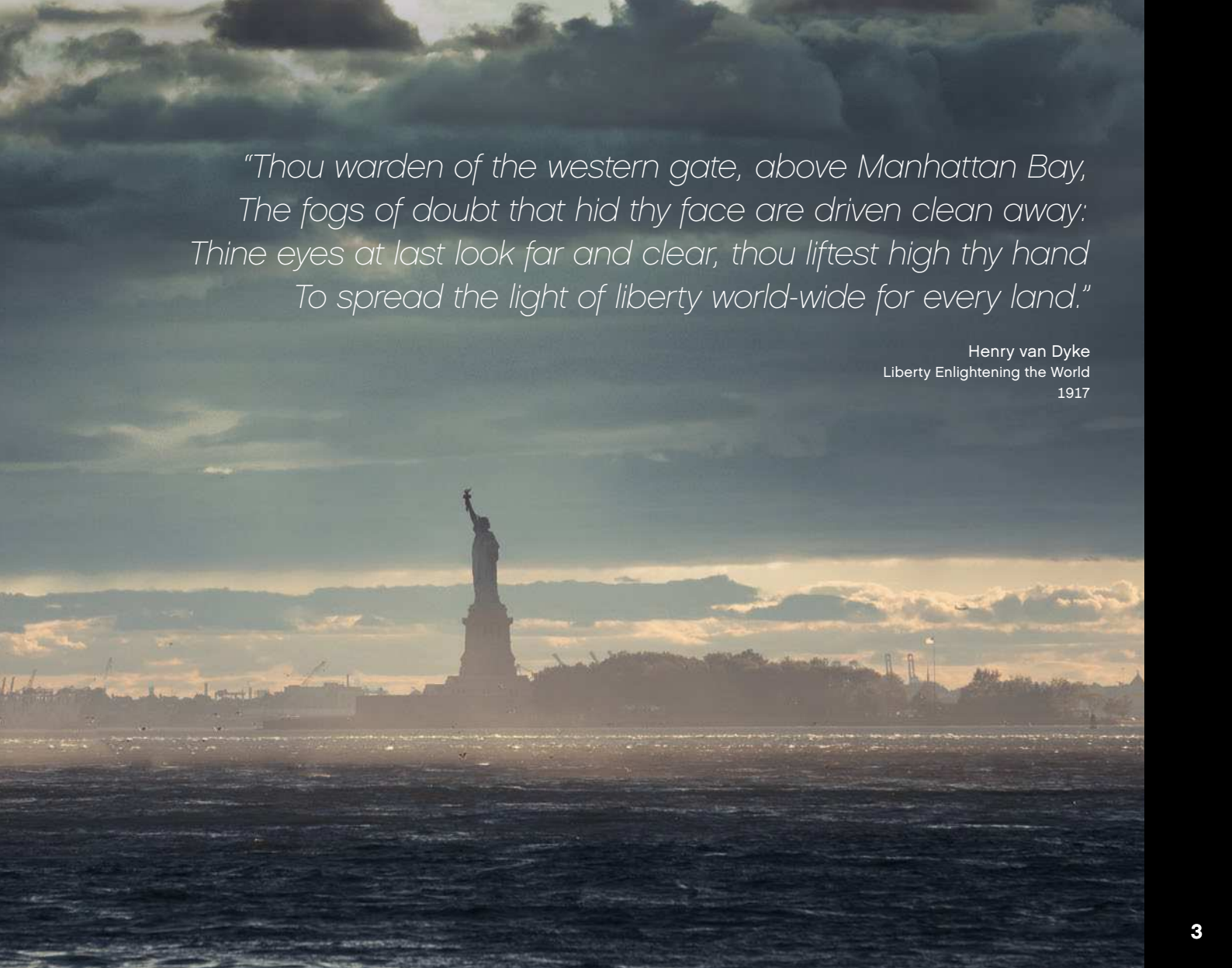

A photograph of the Statue of Liberty on Liberty Island, New York, silhouetted against a dramatic sunset sky. The sun is low on the horizon, creating a golden glow and long shadows. The water in the foreground is dark with some whitecaps. The sky is filled with large, dark clouds, some of which are illuminated from below by the setting sun.

*"Thou warden of the western gate, above Manhattan Bay,
The fogs of doubt that hid thy face are driven clean away:
Thine eyes at last look far and clear, thou liftest high thy hand
To spread the light of liberty world-wide for every land."*

Henry van Dyke
Liberty Enlightening the World
1917

The Gift

Édouard de Labouaye was a prominent French political thinker and a strong supporter of President Abraham Lincoln during the American Civil War. In 1865, he proposed creating a monument that would be gifted to the United States by the people of France in celebration of the recent Union victory in the Civil War and the abolition of slavery.

Ten years later, with the help of the sculptor Frédéric-Auguste Bartholdi, Labouaye turned his proposal into reality and founded the Franco-American Union to raise funds for the project. It was hoped that the French people would finance the proposed Statue, now entitled “Liberty Enlightening the World,” while the American people would pay for its pedestal.

On one of his trips to the U.S. to help raise funds, the sculptor Bartholdi realized that New York was the gateway to America and spotted the perfect location for the Statue to stand.



Bedloe's Island was visible to every ship entering or leaving the city's harbor and Bartholdi envisioned his statue rising out of the star-shaped Fort Wood that already stood on the island.

The project soon caught the imagination of many on both sides of the Atlantic, and when the French had raised 400,000 francs the construction of the Statue finally began.

*"...a stream of light shall pierce the darkness
...until Liberty enlightens the world"*

President Grover Cleveland
Dedication speech for the Statue of Liberty
October 28, 1886







From Dream to Reality

In 1876, French craftsmen began forging the individual elements of the Statue. While the outer design and materials were given, the real challenge lay in the Statue's internal construction.

Bartholdi turned to the French architect and structural engineer, Gustave Eiffel, and he proposed creating a 92 ft. (28 m) skeletal central pylon upon which asymmetrical girders could be attached. Flat metal bars were then bolted to the girders to hold the copper skin of the Statue in place. Eiffel would go on to use the same pylon construction method in his famous Eiffel Tower, which was completed in 1889.

The entire Statue was completed in Paris between 1881 and 1884. It arrived amid great fanfare in New York aboard the French Navy ship *Isère* on the 17th of June 1885. Once the pedestal was completed in 1886, the 151 ft. (46 m) tall statue was quickly assembled. The last section to be completed was the Statue of Liberty's face, which remained covered until the official dedication on the 28th of October 1886. Rain and foggy weather did not stop over one million New Yorkers from turning out to cheer the unveiling of the new Statue.

*"Keep, ancient lands, your storied pomp!" cries she
With silent lips. "Give me your tired, your poor,
Your huddled masses yearning to breathe free,
The wretched refuse of your teeming shore.
Send these, the homeless, tempest-tost to me,
I lift my lamp beside the golden door!"*

Emma Lazarus
The New Colossus
1883

A Universal Icon

The Statue of Liberty was intended to be seen as a universal symbol of enlightenment and freedom. The robed female figure itself represents Libertas, the Roman goddess of freedom, and although you cannot see her feet clearly she stands among a broken shackle and chains, with her right foot raised, depicting her moving away from oppression and slavery. The seven spikes on the crown represent the seven oceans and the seven continents of the world, reinforcing the universal concept of liberty.

Over time, the Statue would also emerge as a welcoming symbol of hope to different generations of immigrants to the U.S. Between 1886 and 1924, almost 14 million immigrants

entered the United States through New York. The Statue of Liberty was often the first thing they saw as they arrived by ship in their new homeland.

The American National Park Service took over responsibility for the island in 1937, and set about transforming the area around the Statue into a park. Bedloe's Island was renamed Liberty Island in 1957 to commemorate the completion of this work. The Statue was designated a UNESCO World Heritage Site in 1984 and continues to attract around 4 million visitors each year.







Facts & Figures

Style	Neoclassical Sculpture
Materials	Statue: Copper & Iron Pedestal: Stone
Height	Statue: 151 ft. (46 m) Including Pedestal: 305 ft. (93 m)
Weight	224.9 short tons (204 metric tons)
Dedicated	October 28, 1886

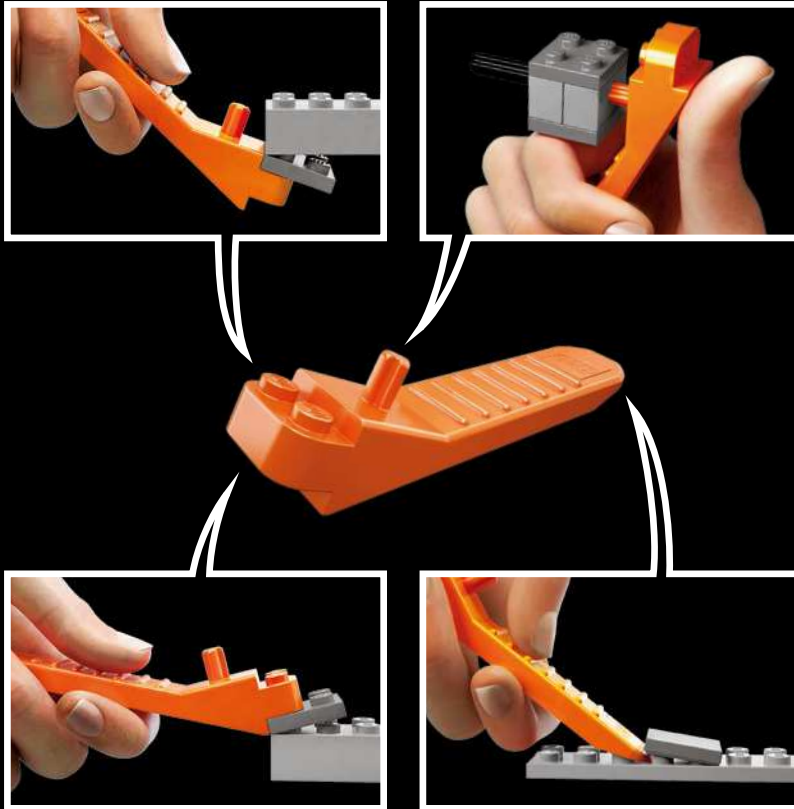

LEGO.com/brickseparator

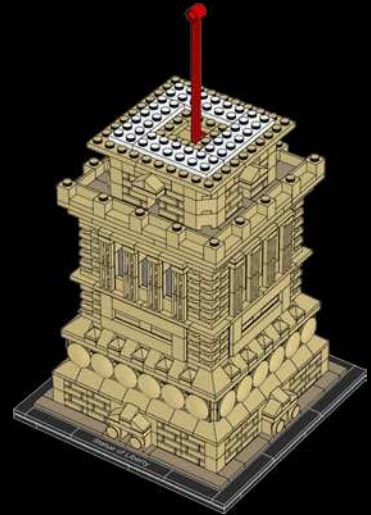
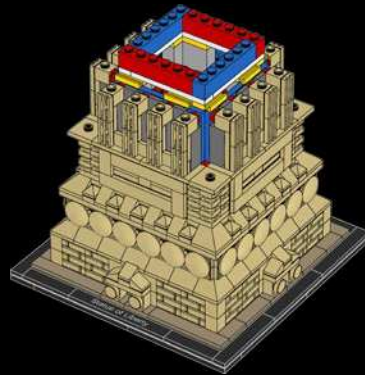
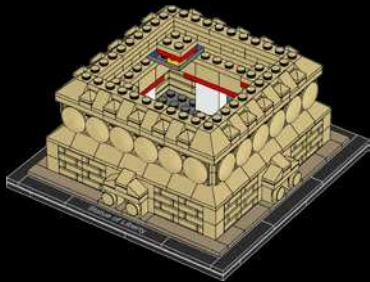
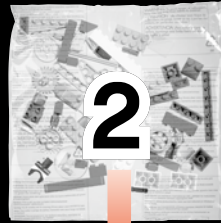



4

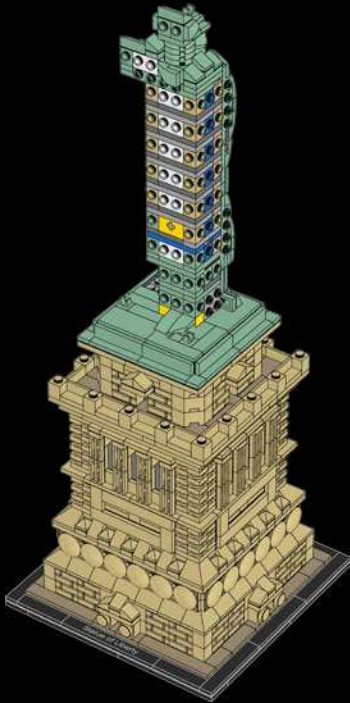

5

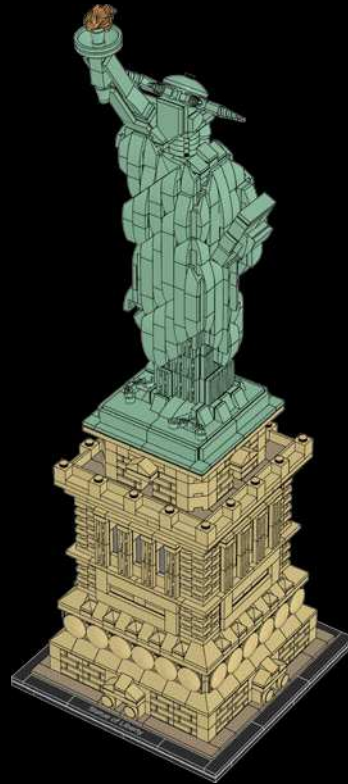

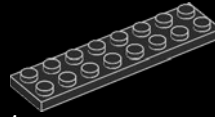
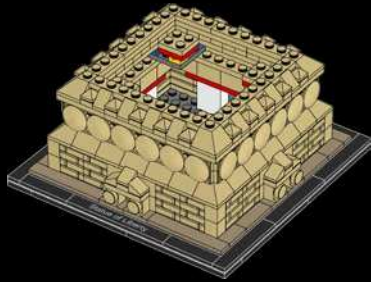

1x

1

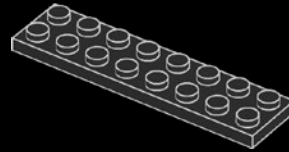

1x



1x

2

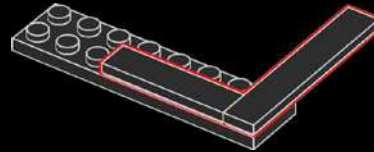

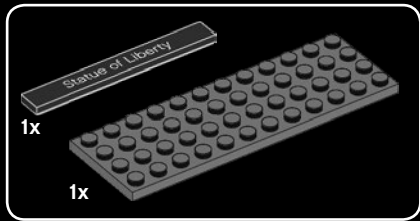

3

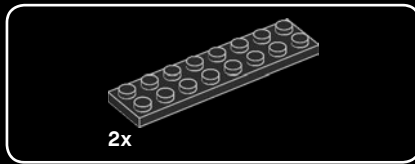
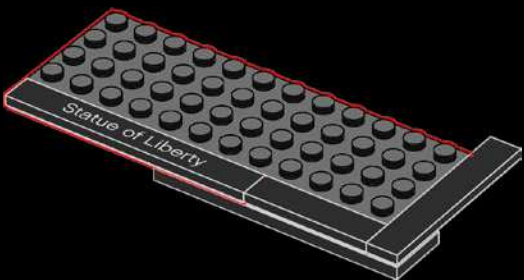

4

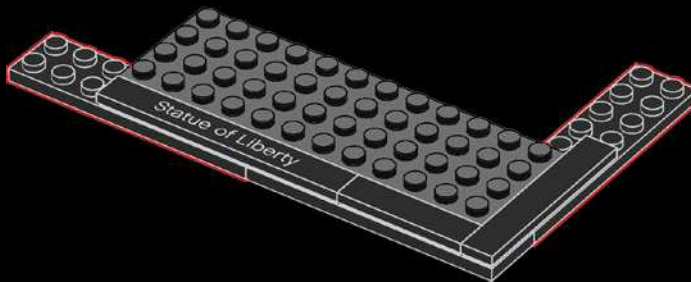

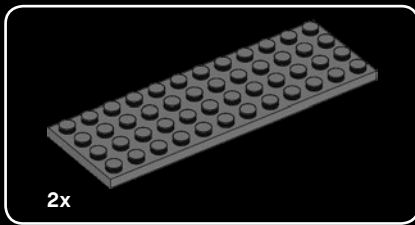

5

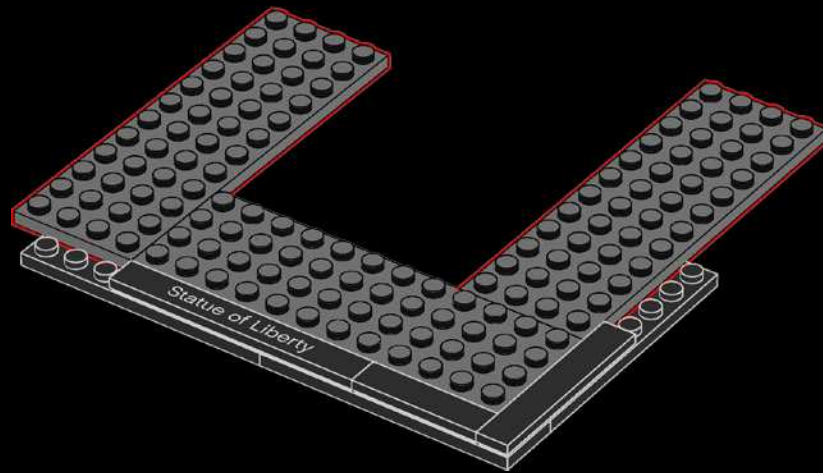

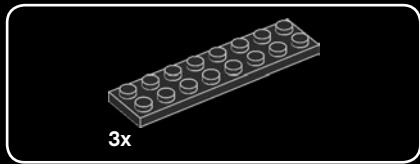

6

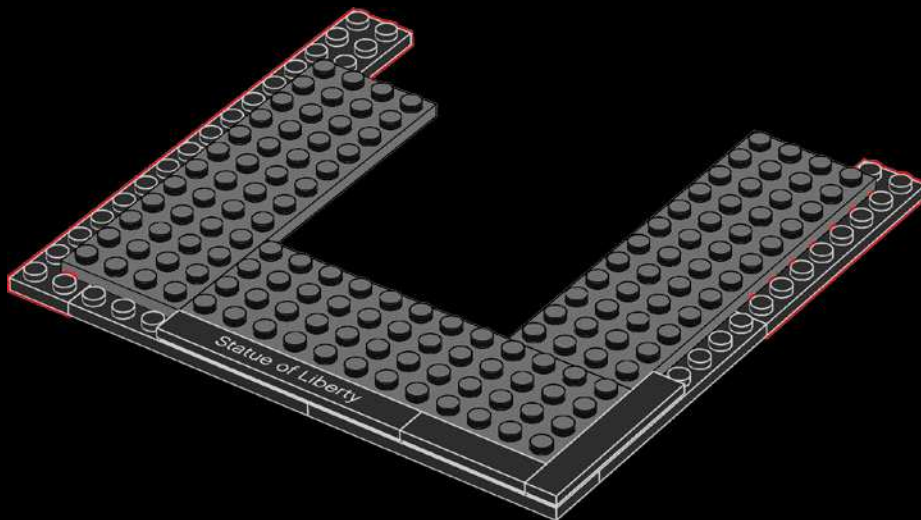

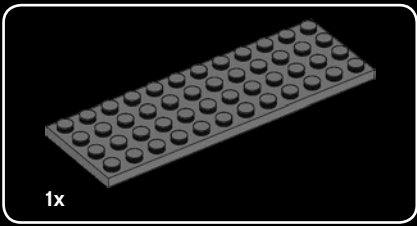

7

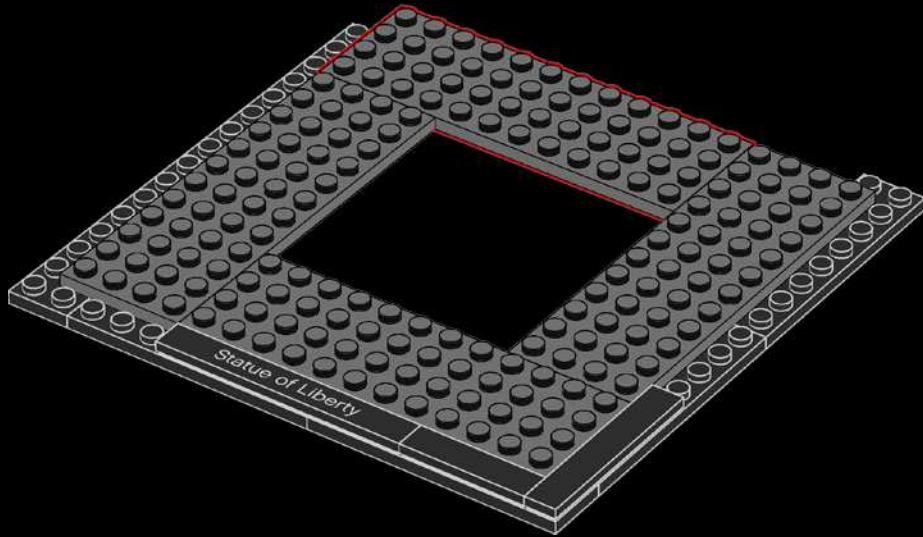

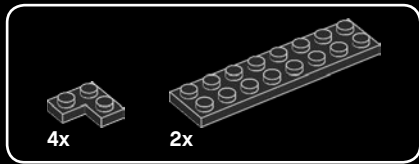

8

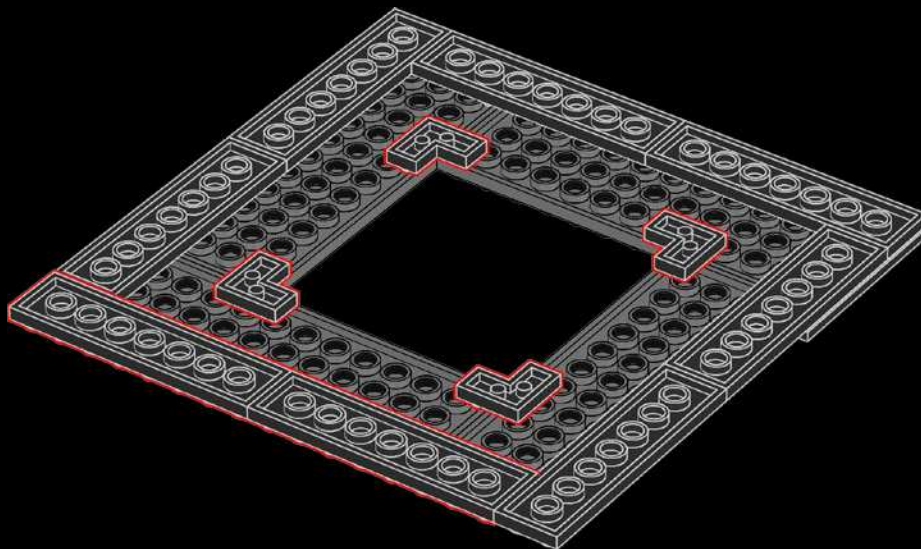

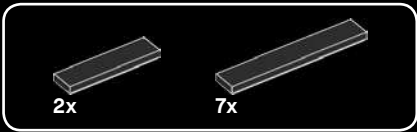

9

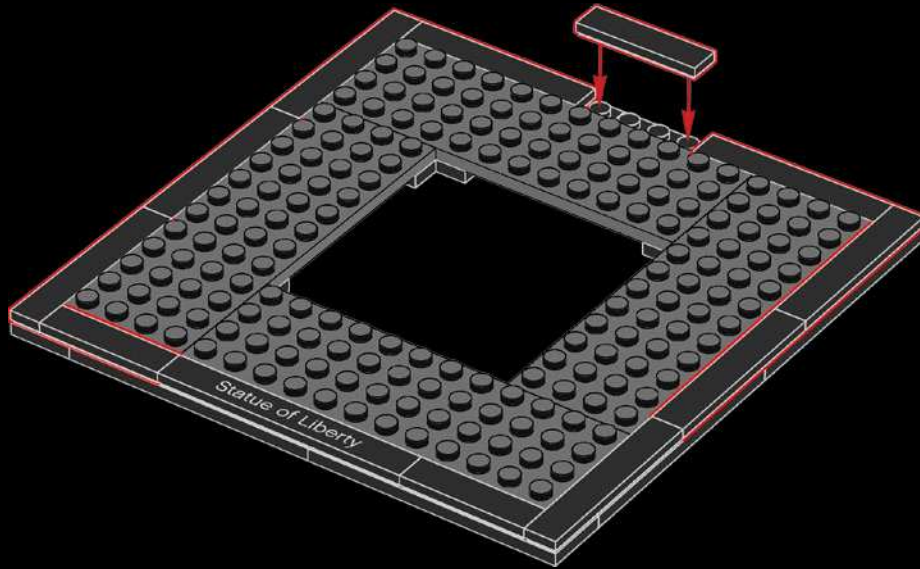
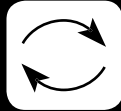

The Statue is thought to be hit by around 600 bolts of lightning every year.



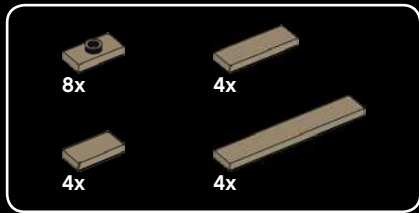

10

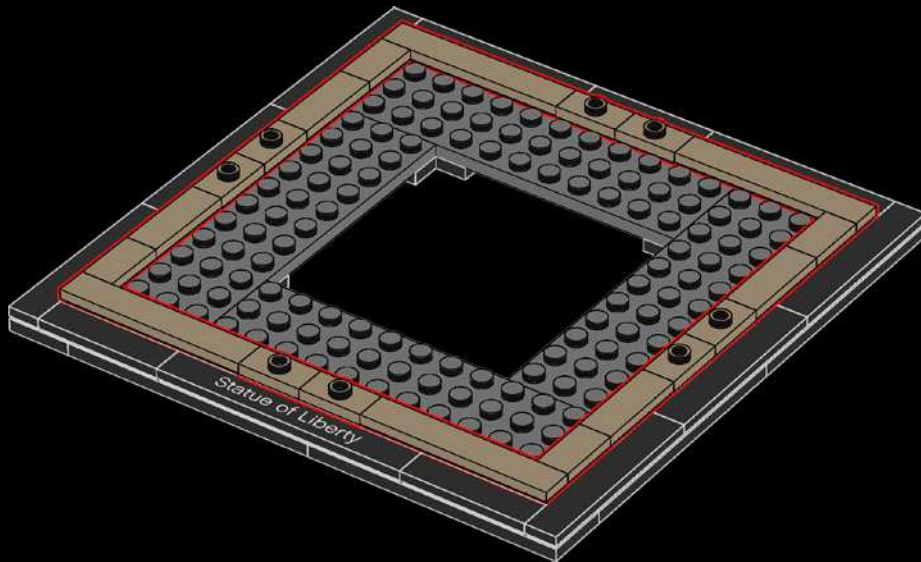

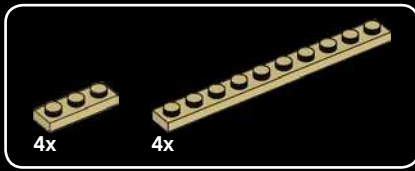

11

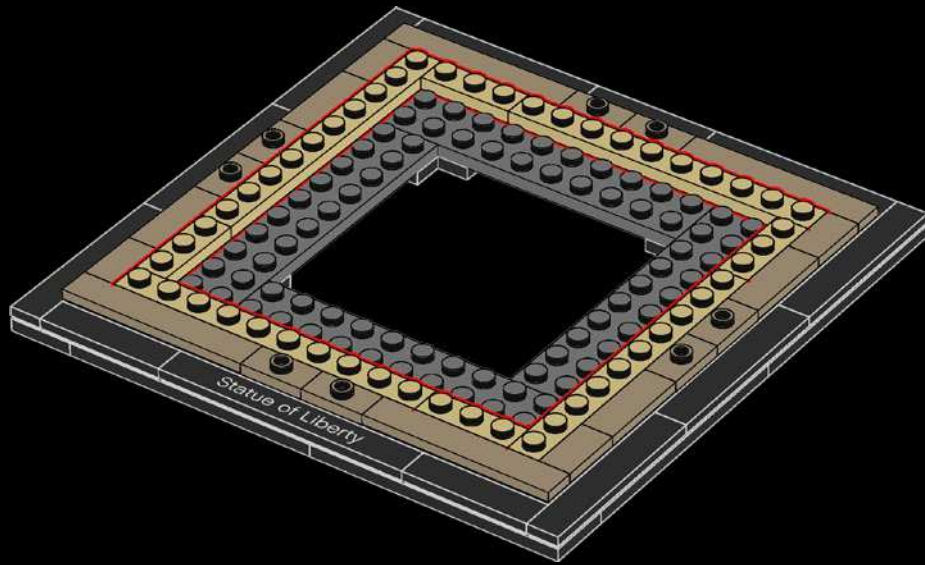



12x



16x

12

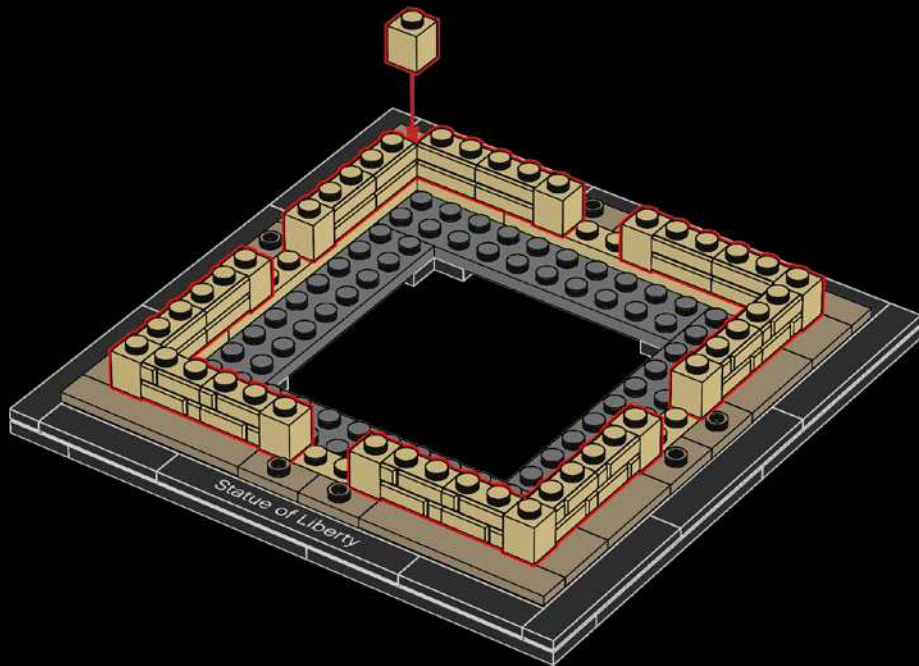

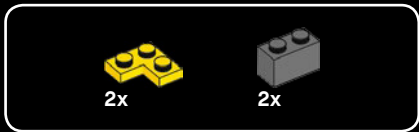

13

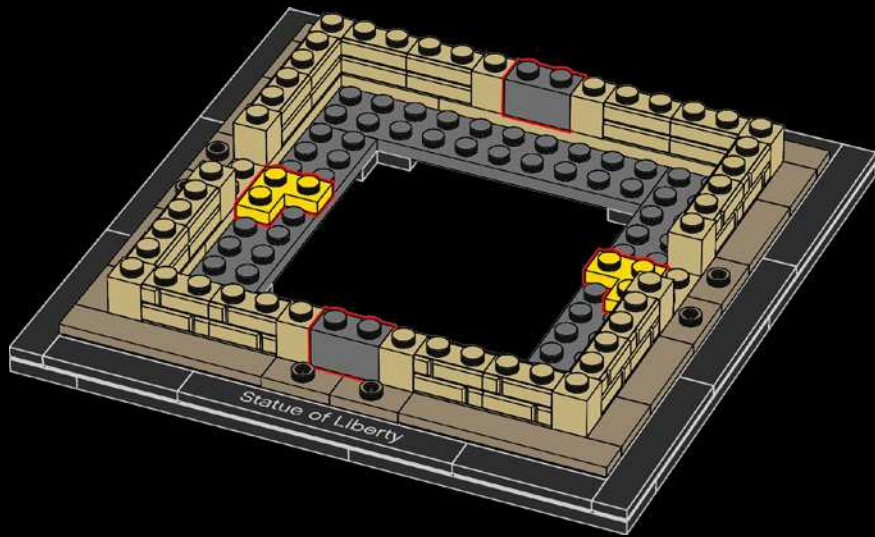

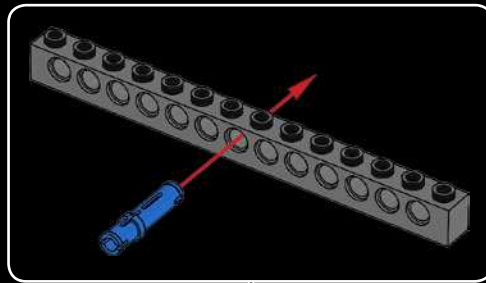
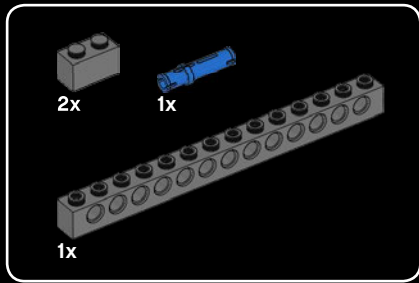

14

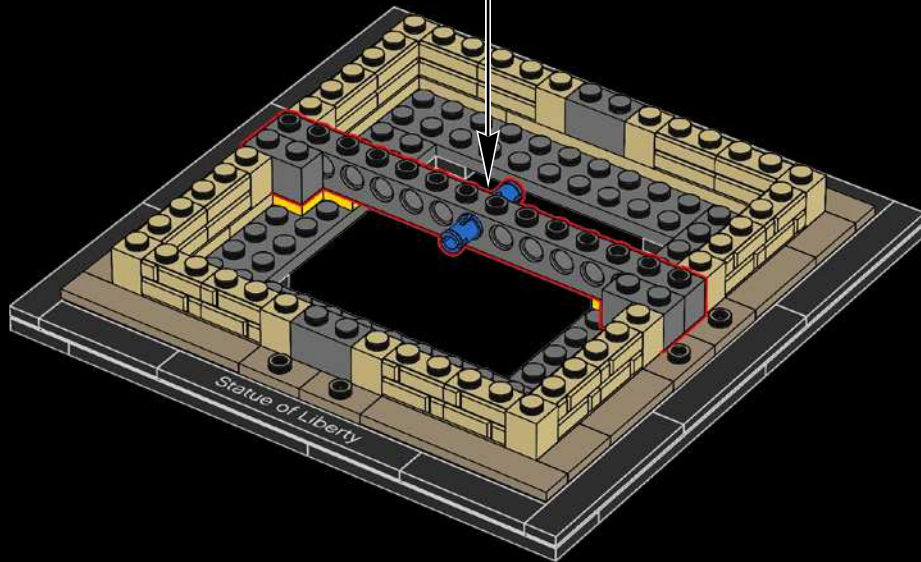



8x



8x

15



8x

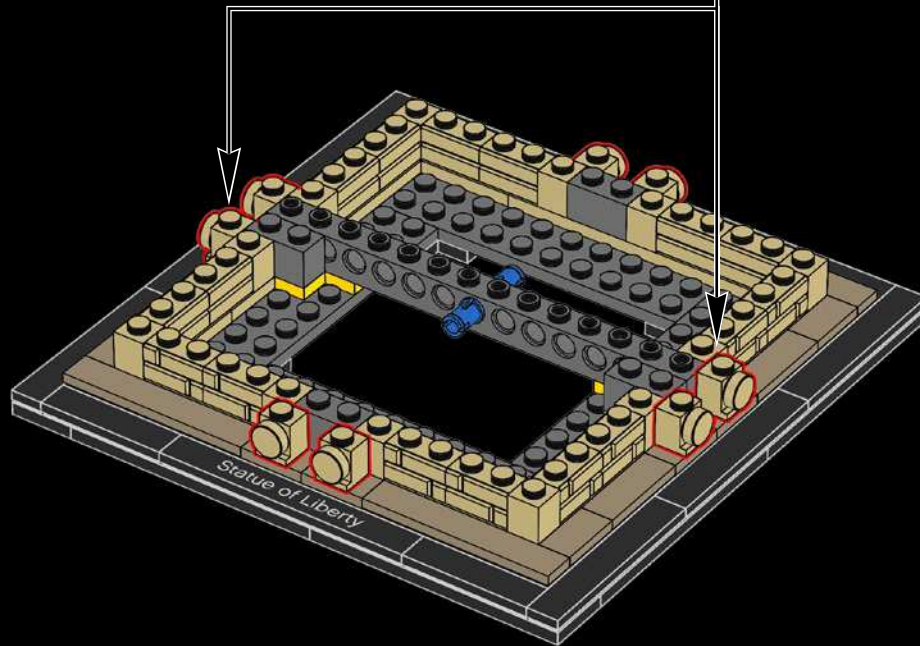



16

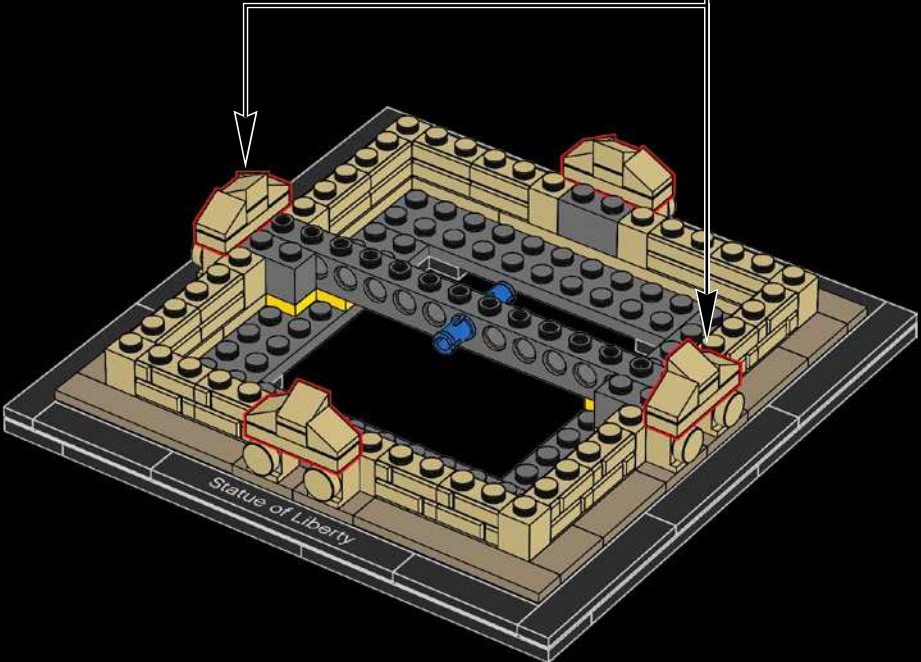
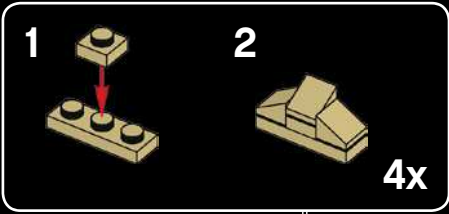

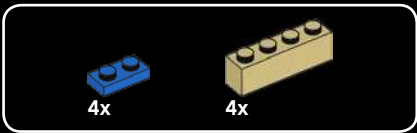

17

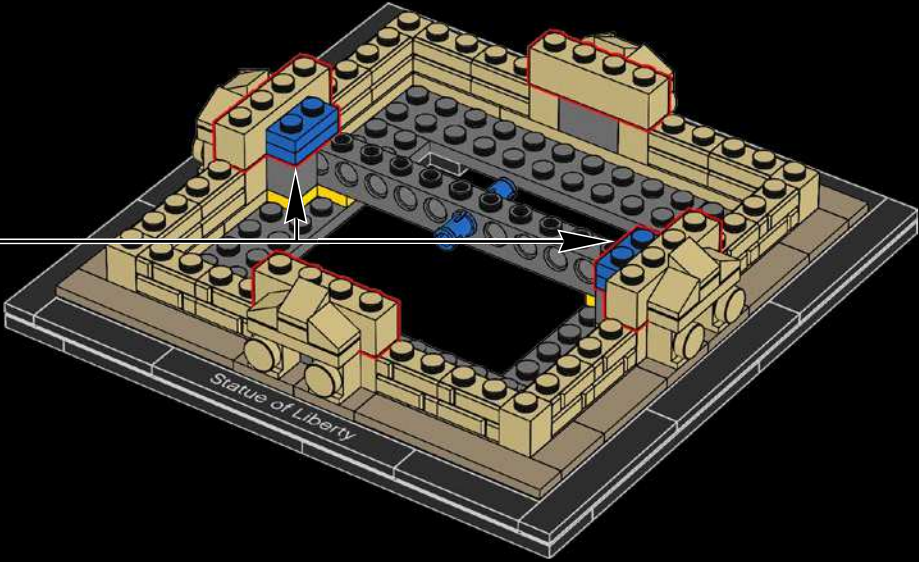
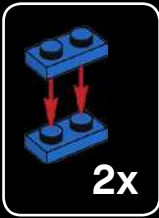



18

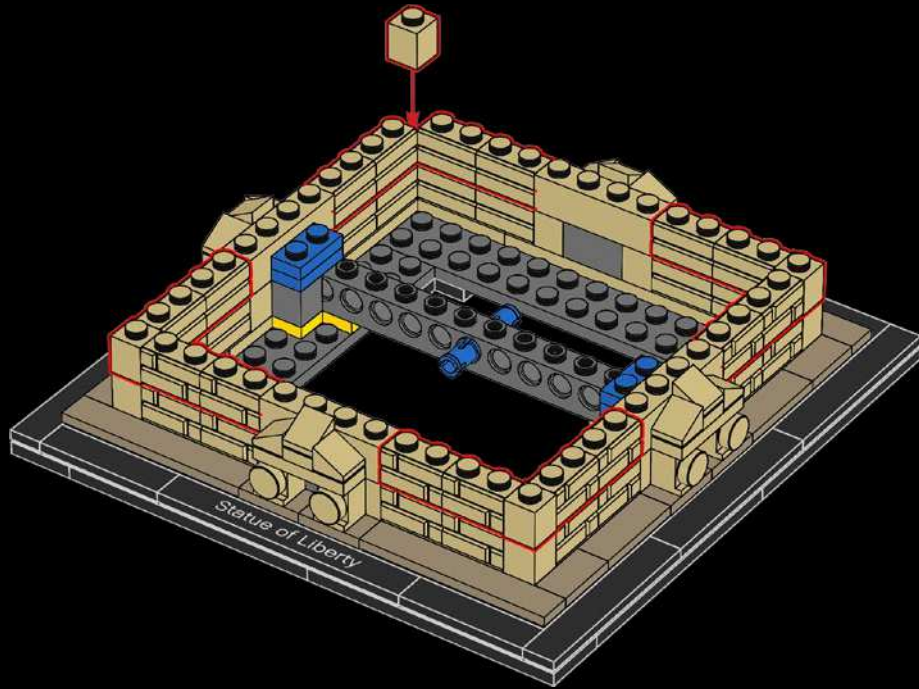

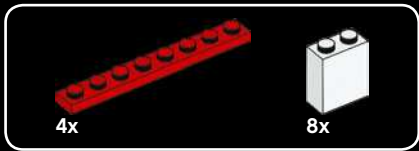

19

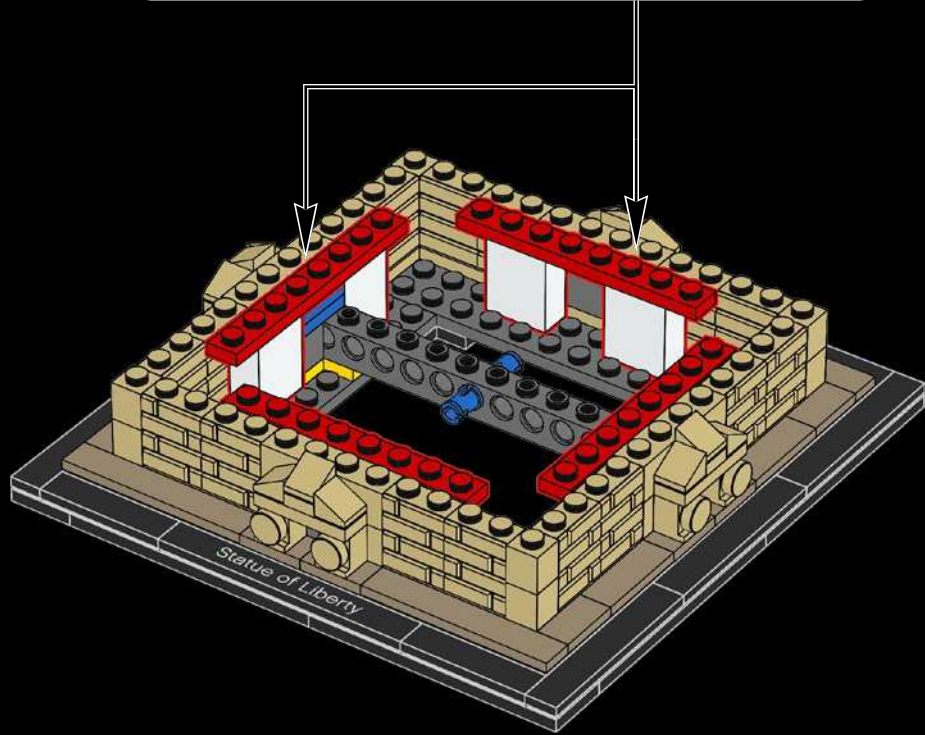
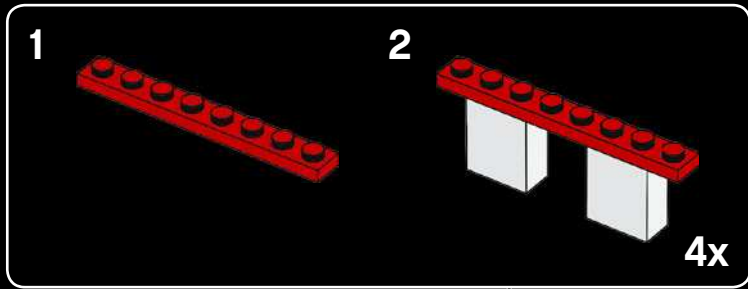



20

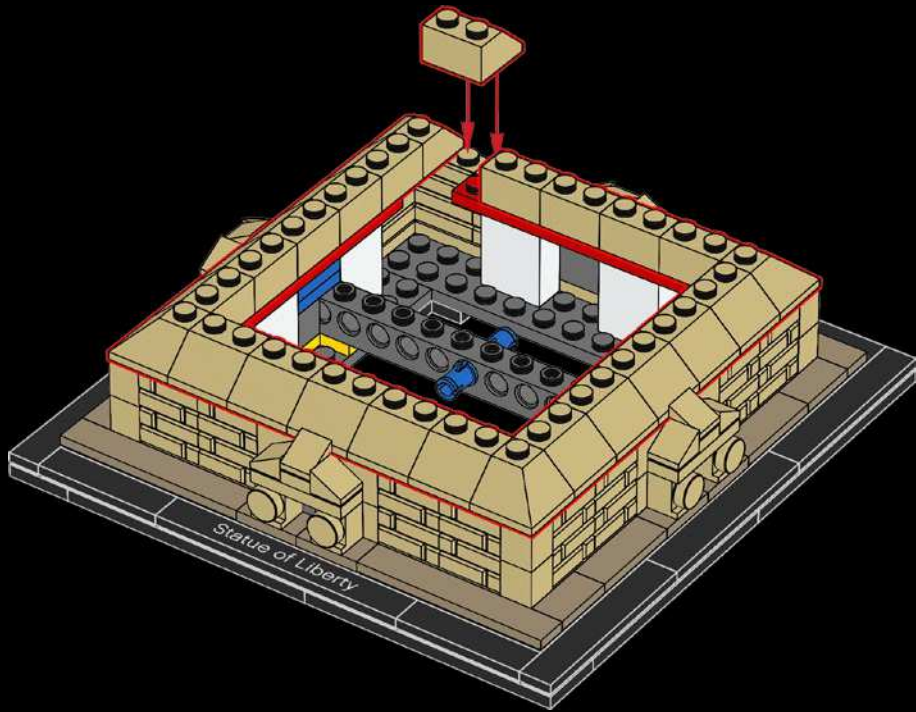



21

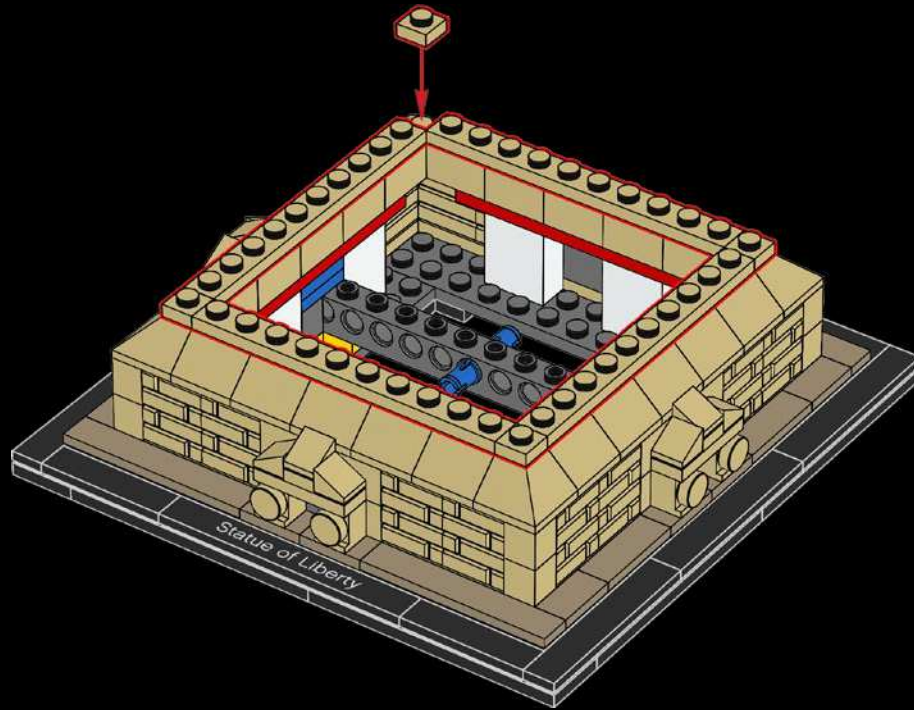



4x

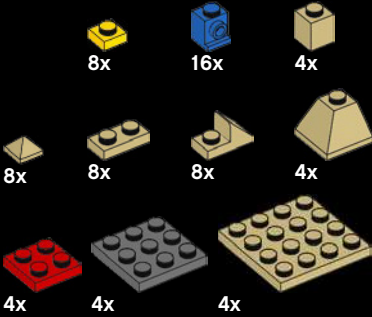

22

1



2

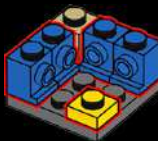

1

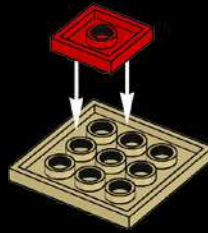

2



3

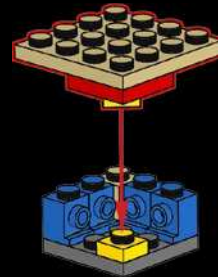

4

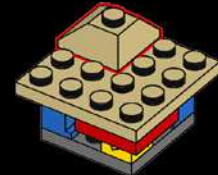

5

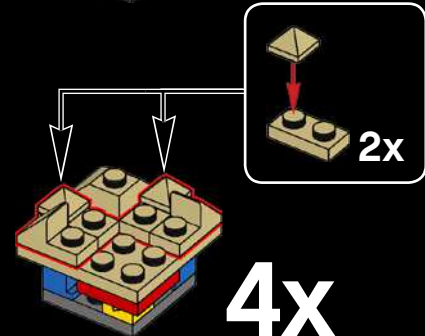

4x

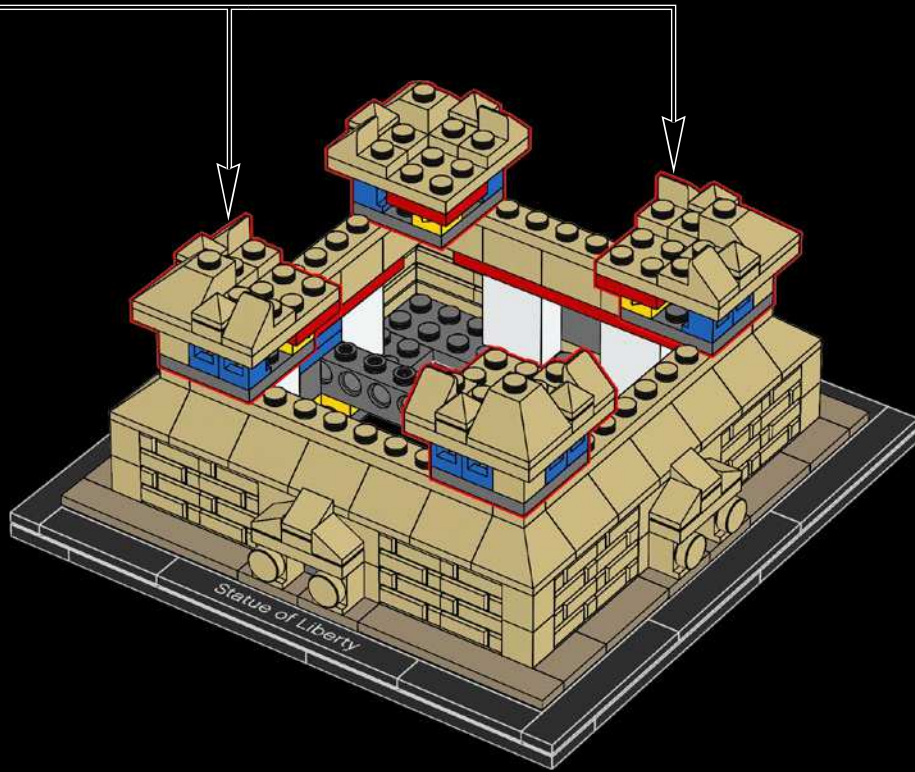

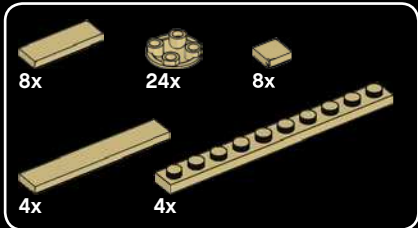
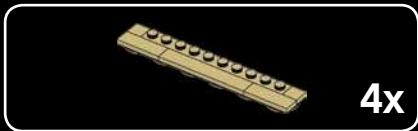

23

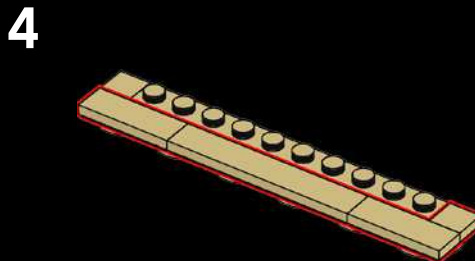
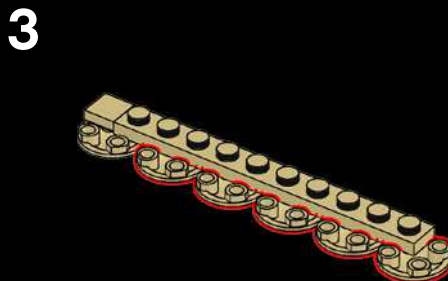
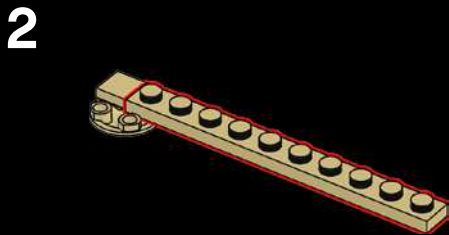
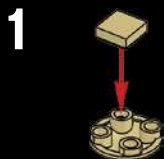

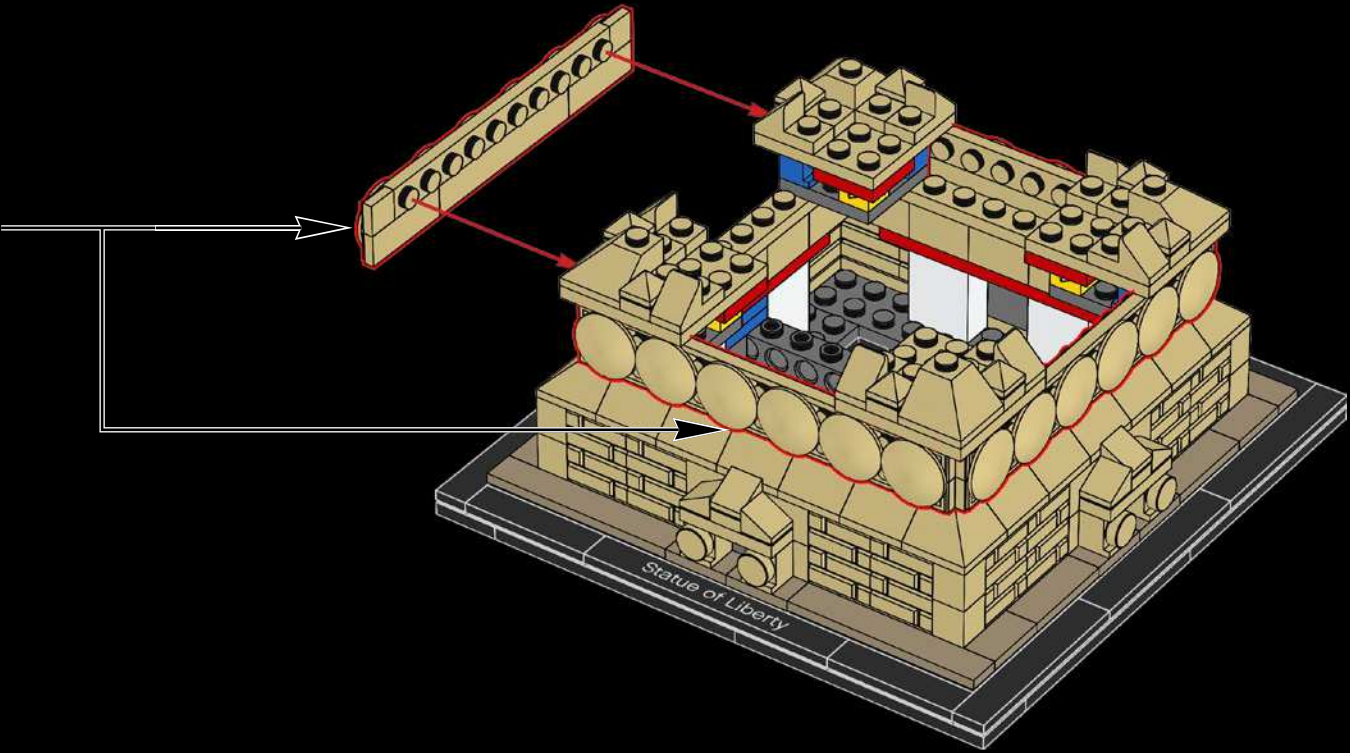

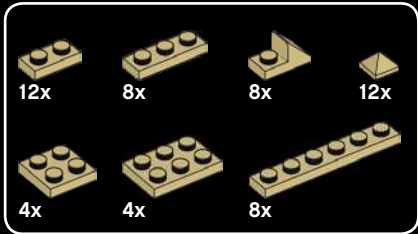
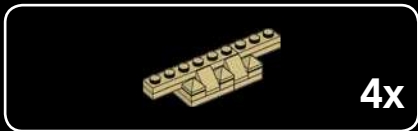

24

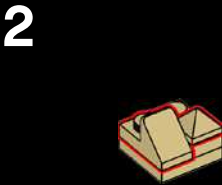
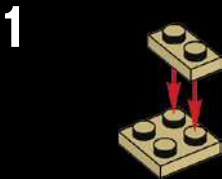

3

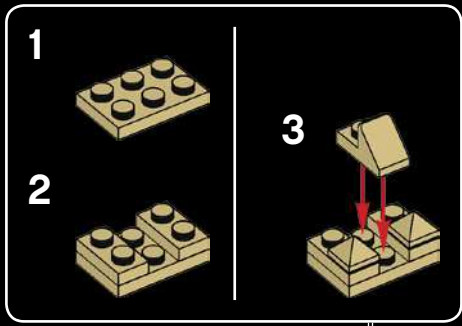
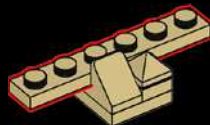

4

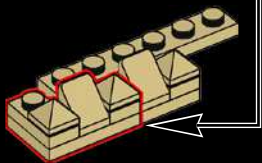

5

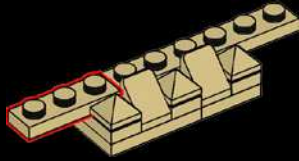

6

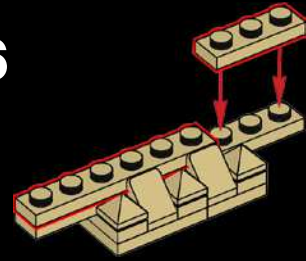

4x

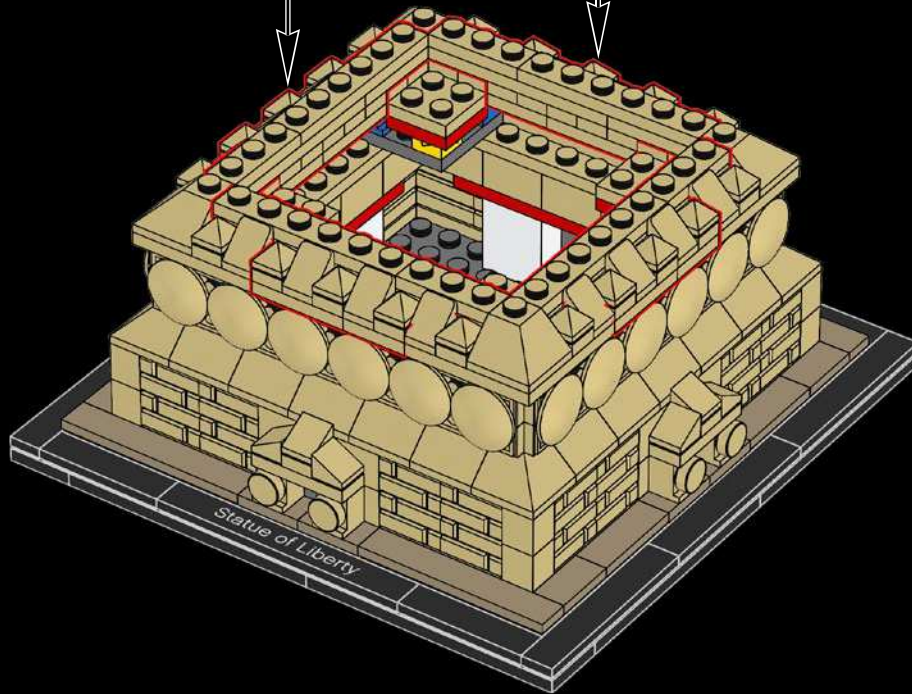

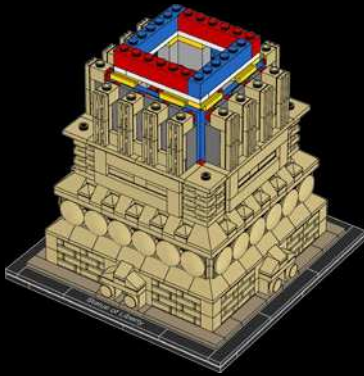
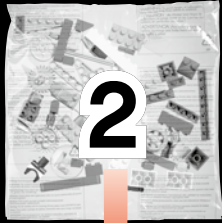

4x

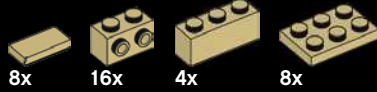

8x

16x

4x

8x

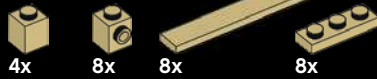

4x

8x

8x

8x

25

1

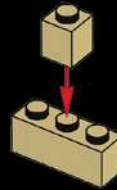

2

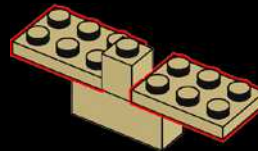

3

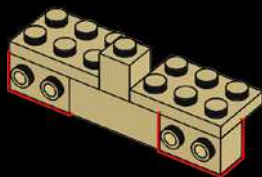

5

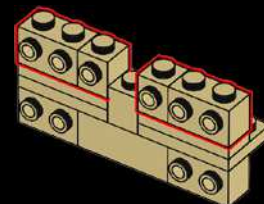

4

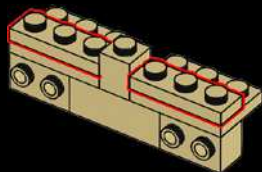

6

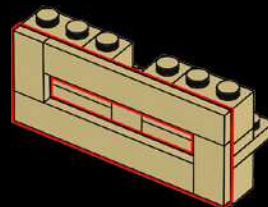

4x
41

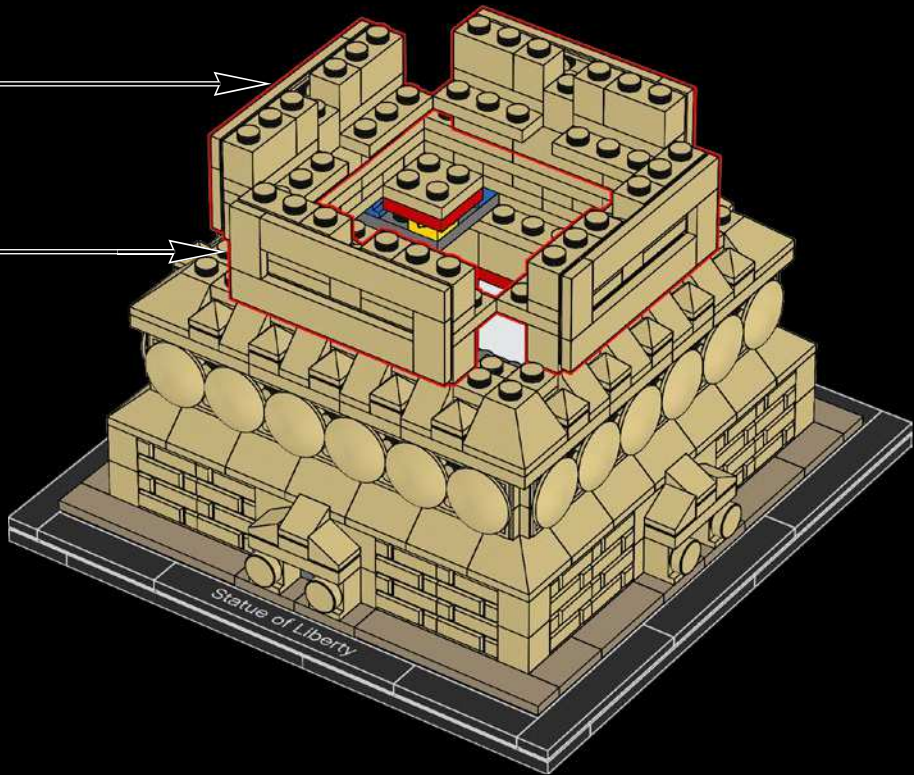

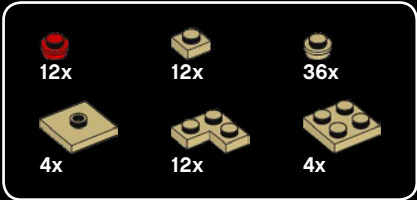

26

1

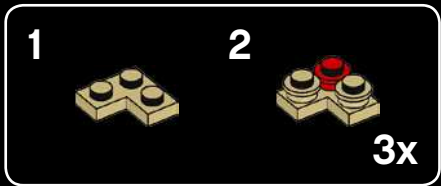

2



3



4



4x

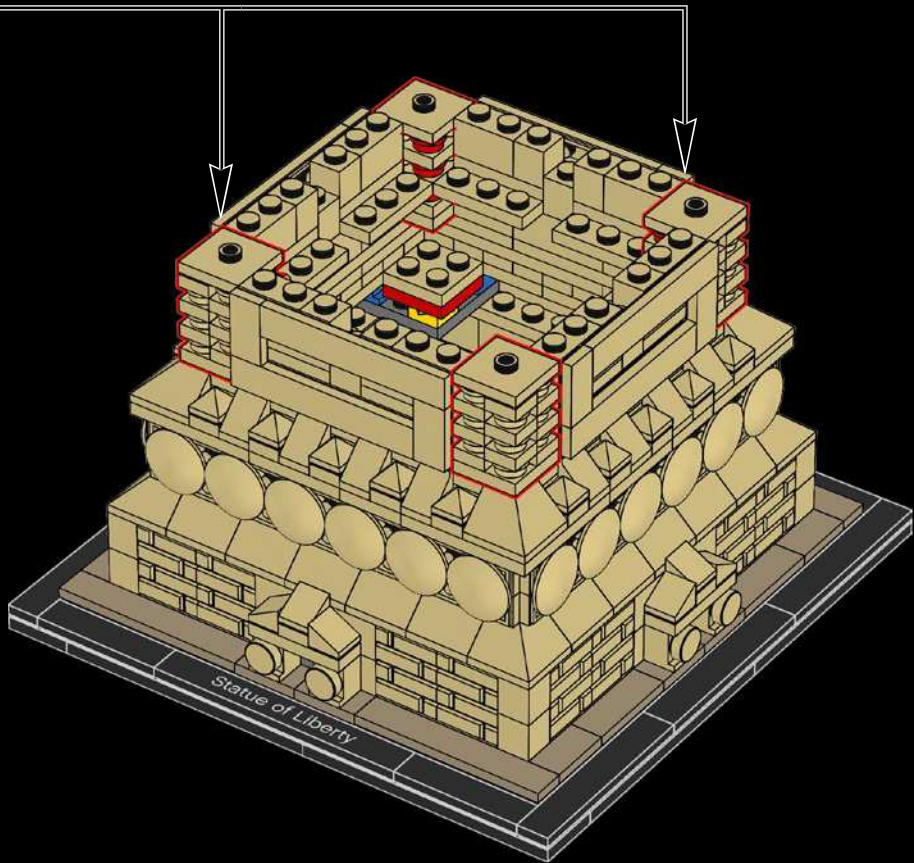

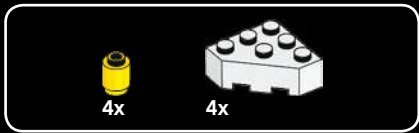

27

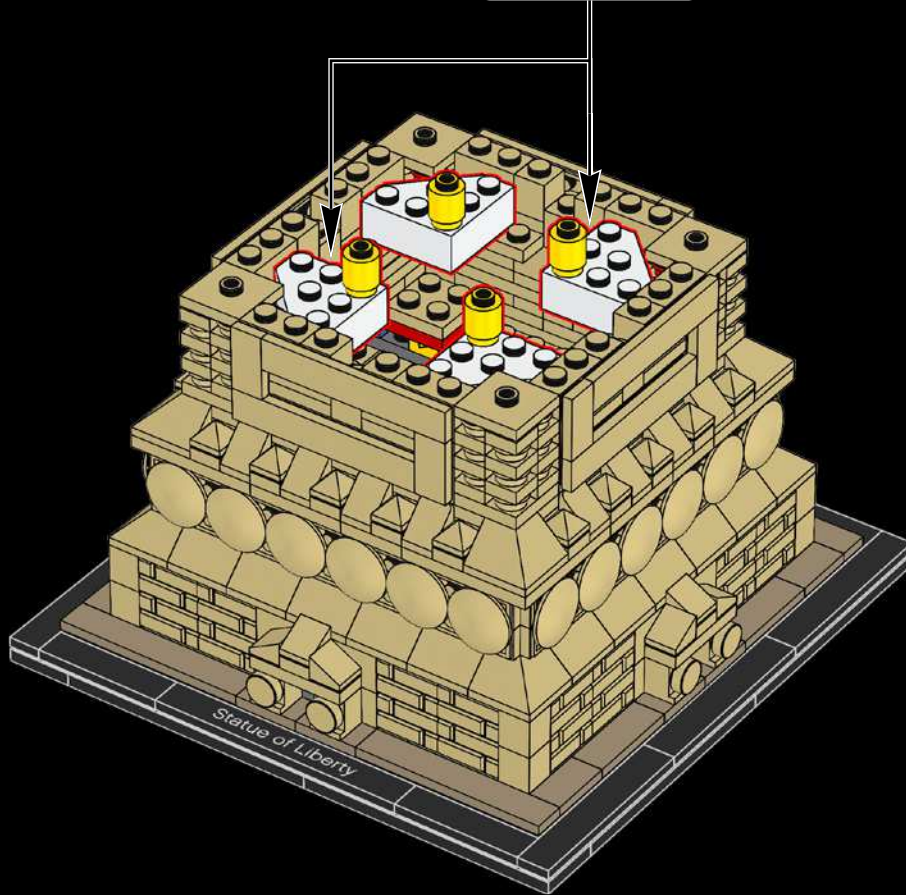
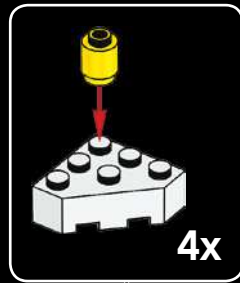

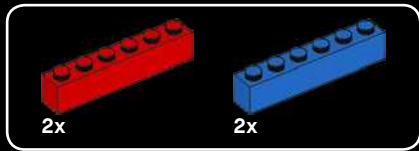

28

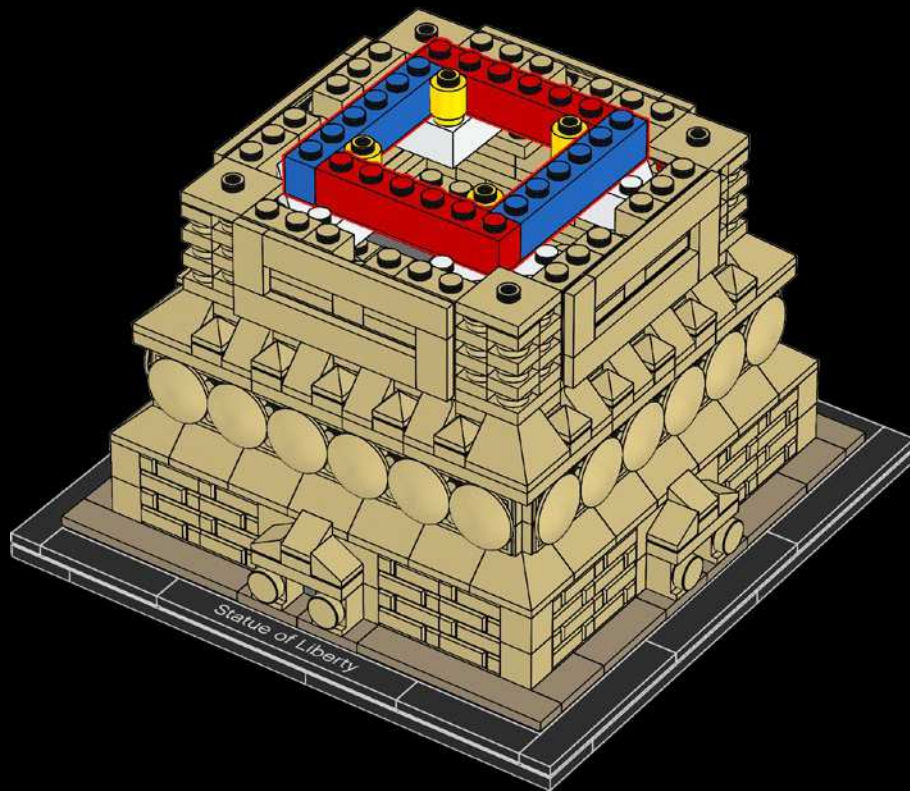



29

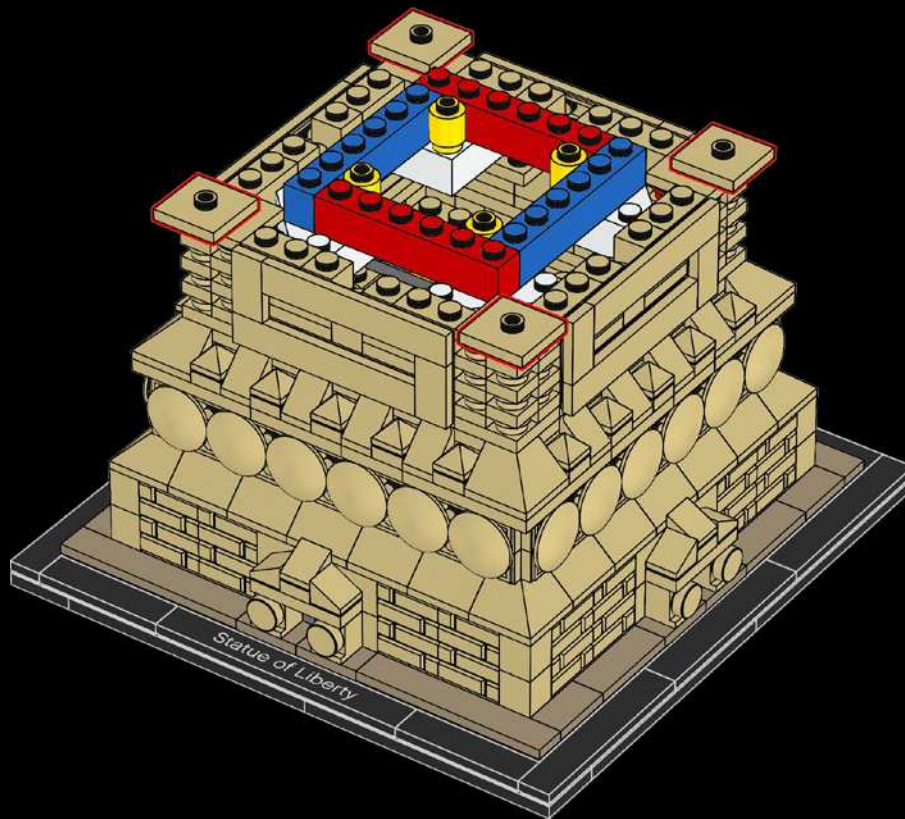



8x

30

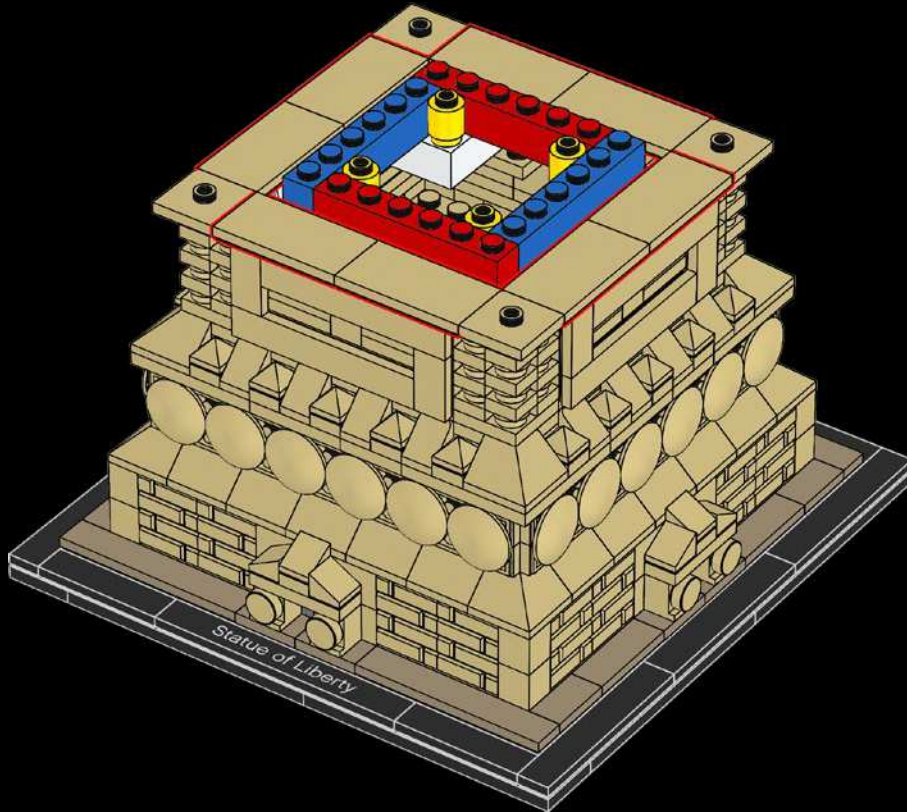

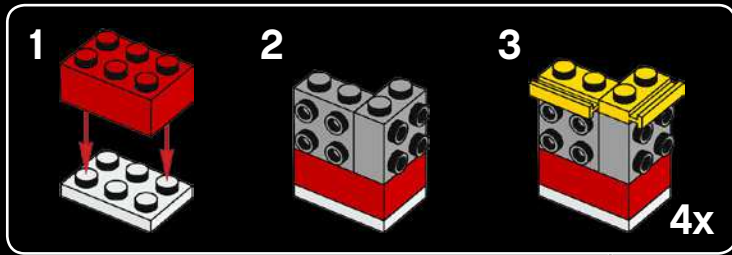
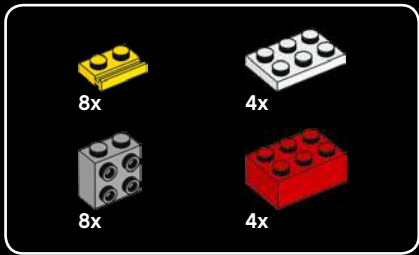

31

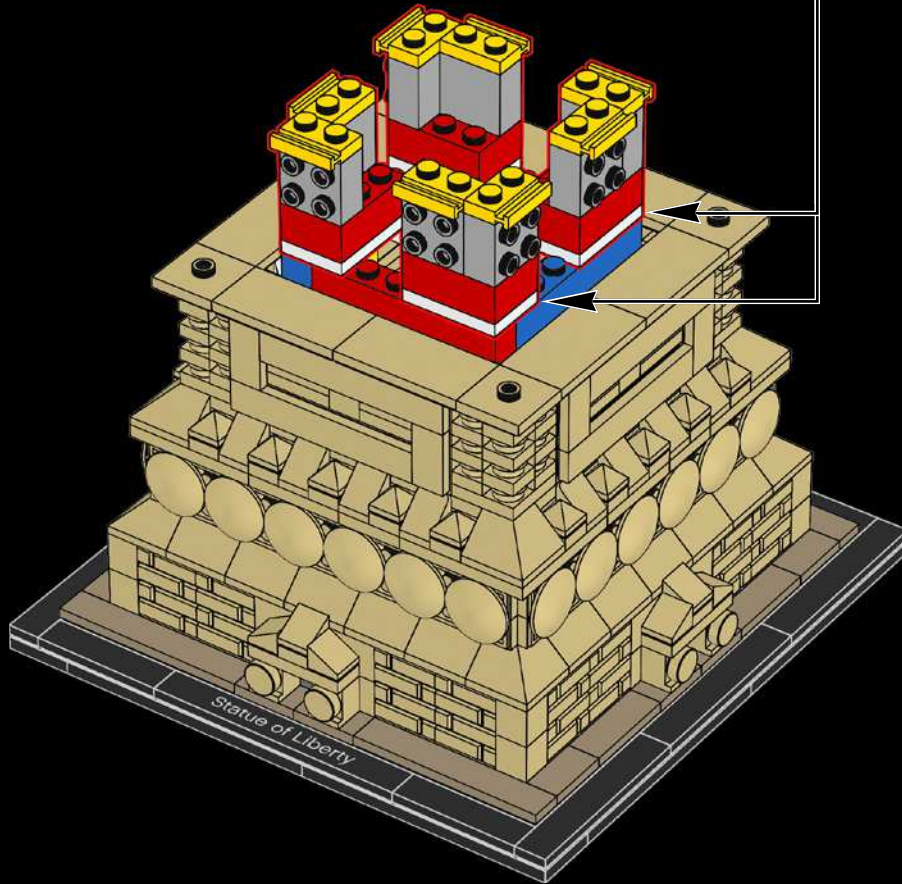



4x

32



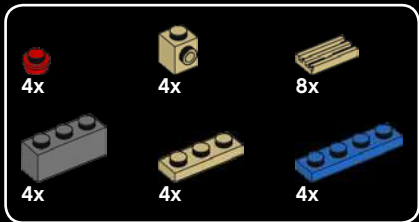

33

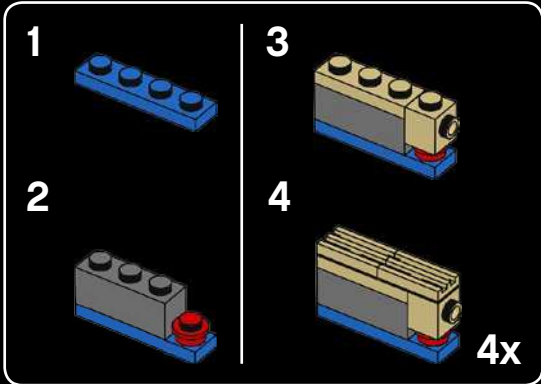
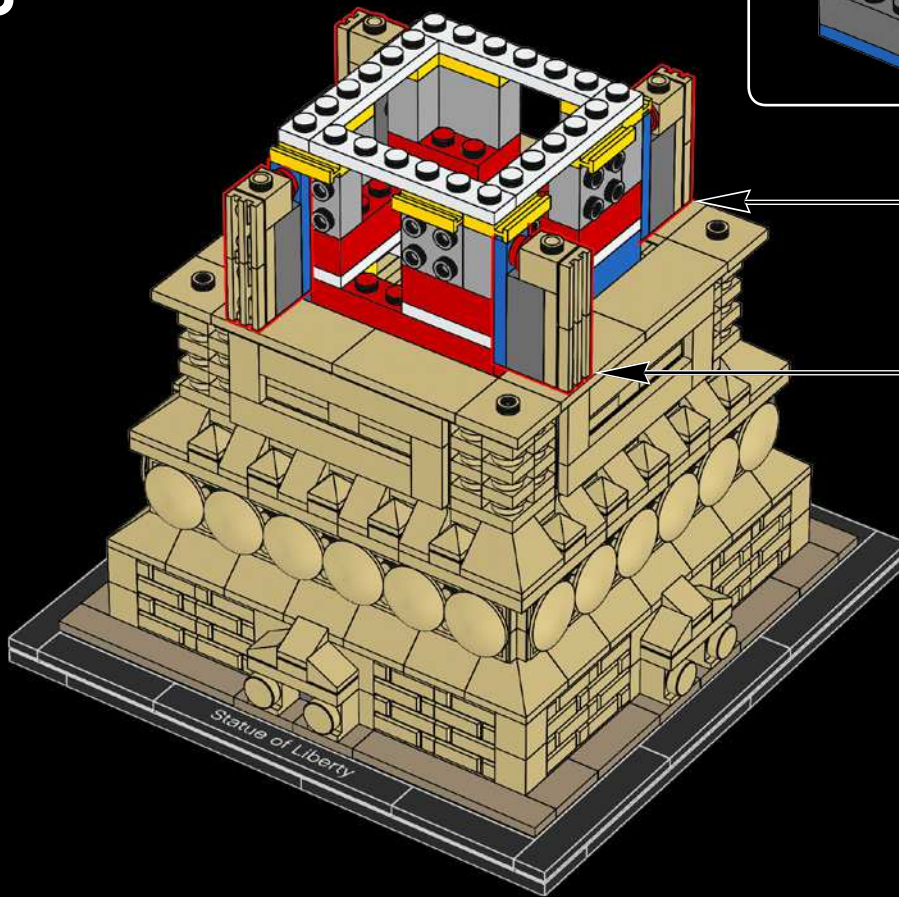

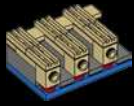

4x

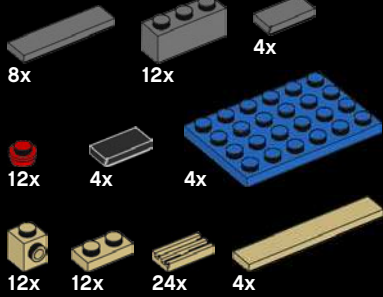

34

1



2

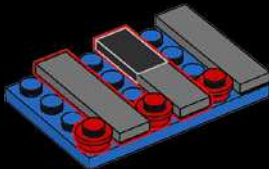

3

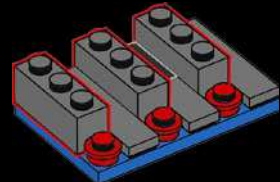

4

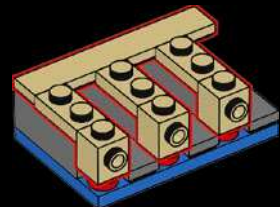

5

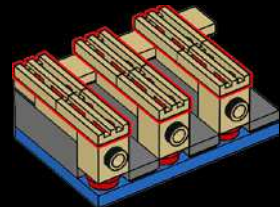

4x

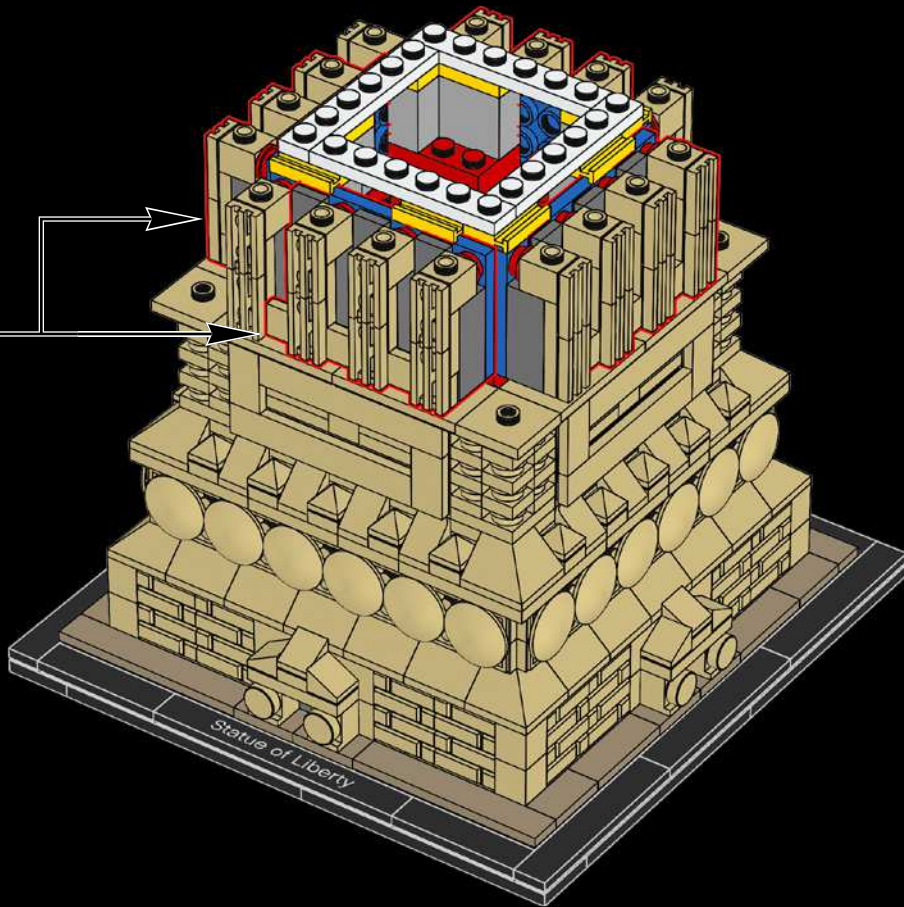

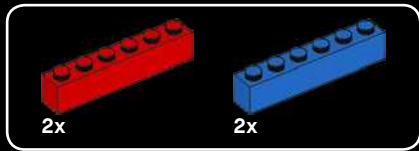

35

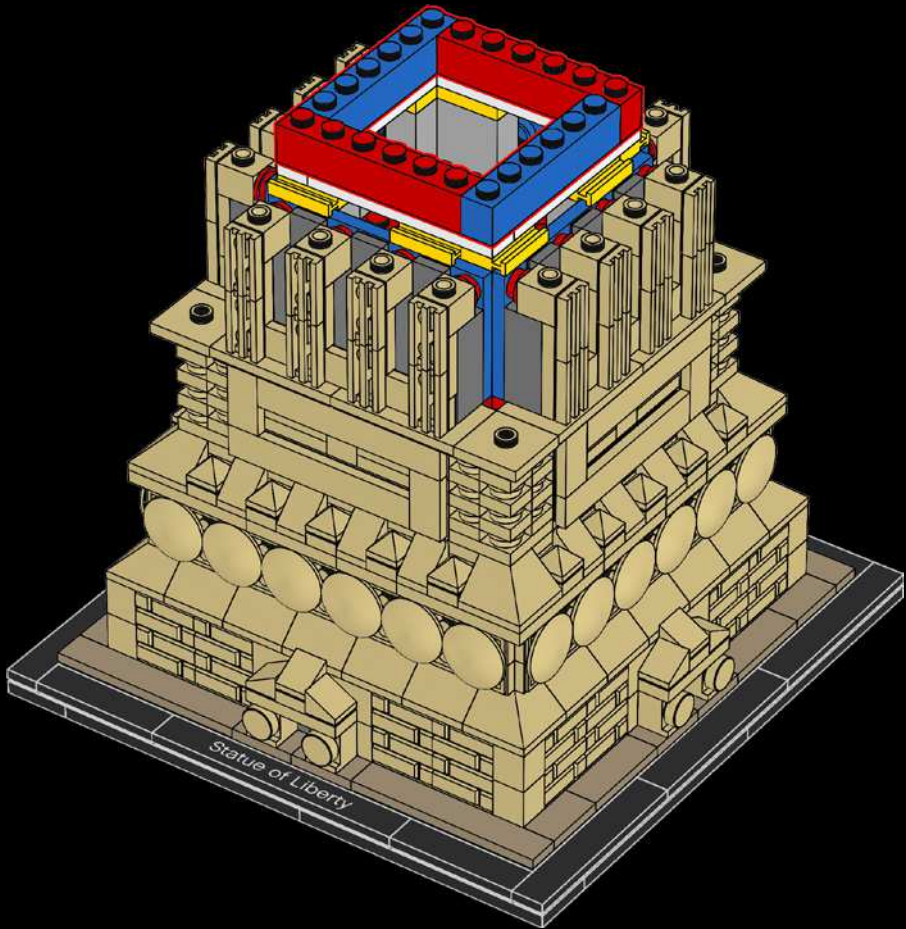

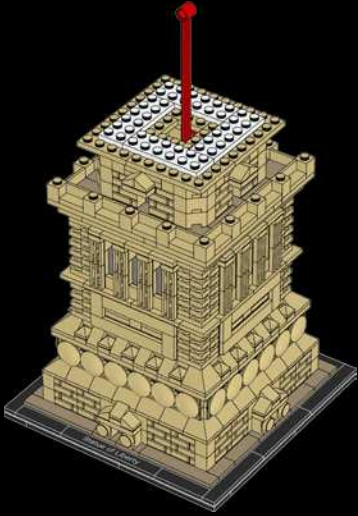
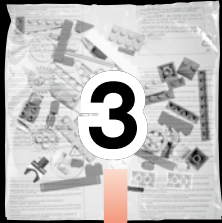

4x



4x

36

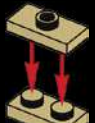

4x

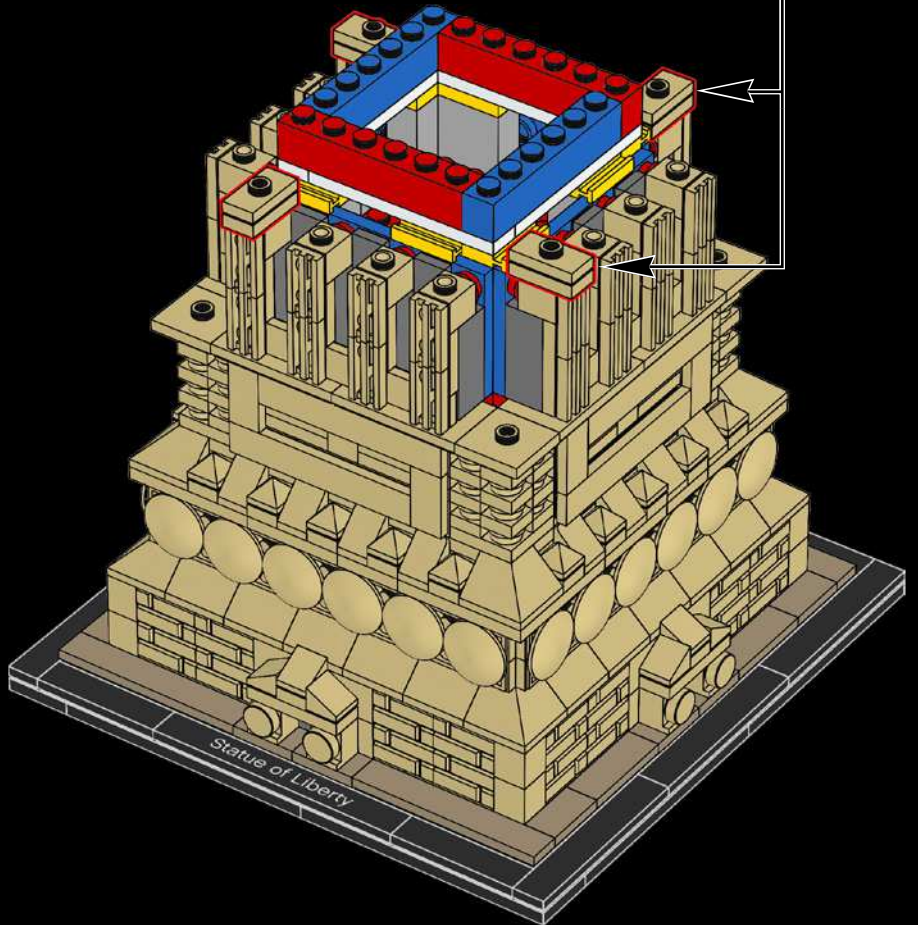

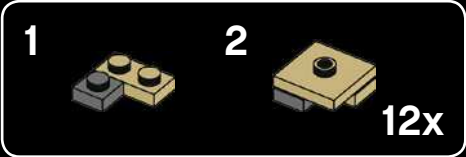

37

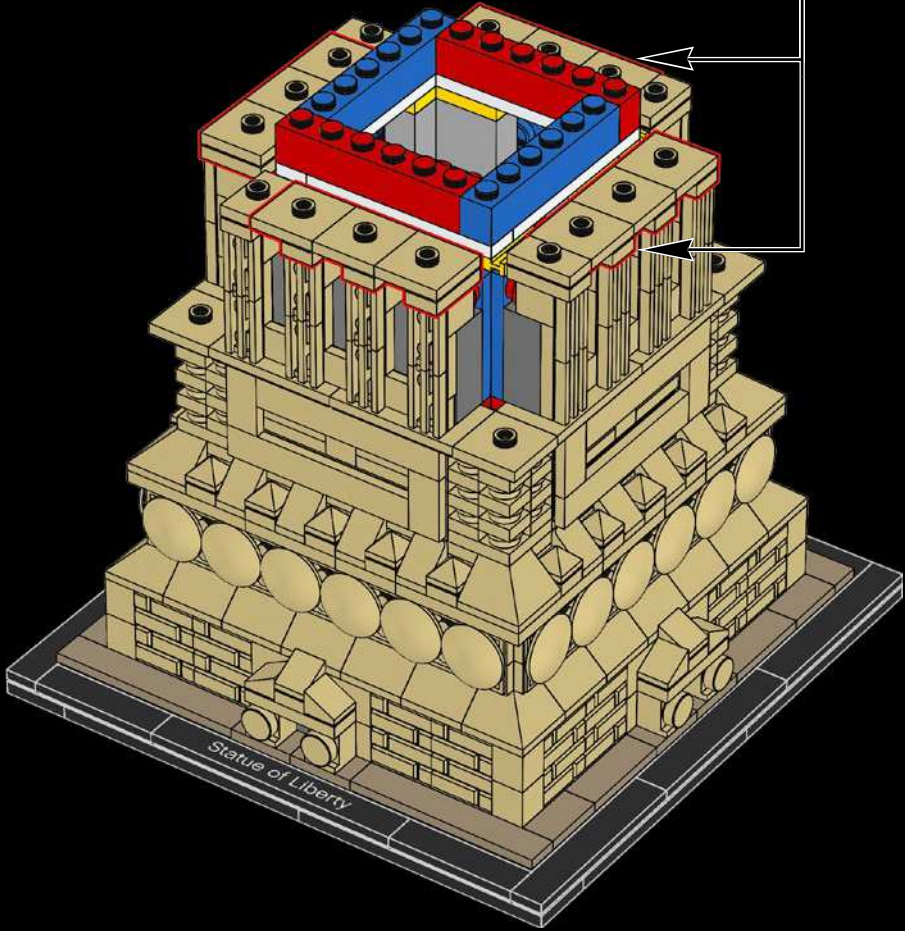



38

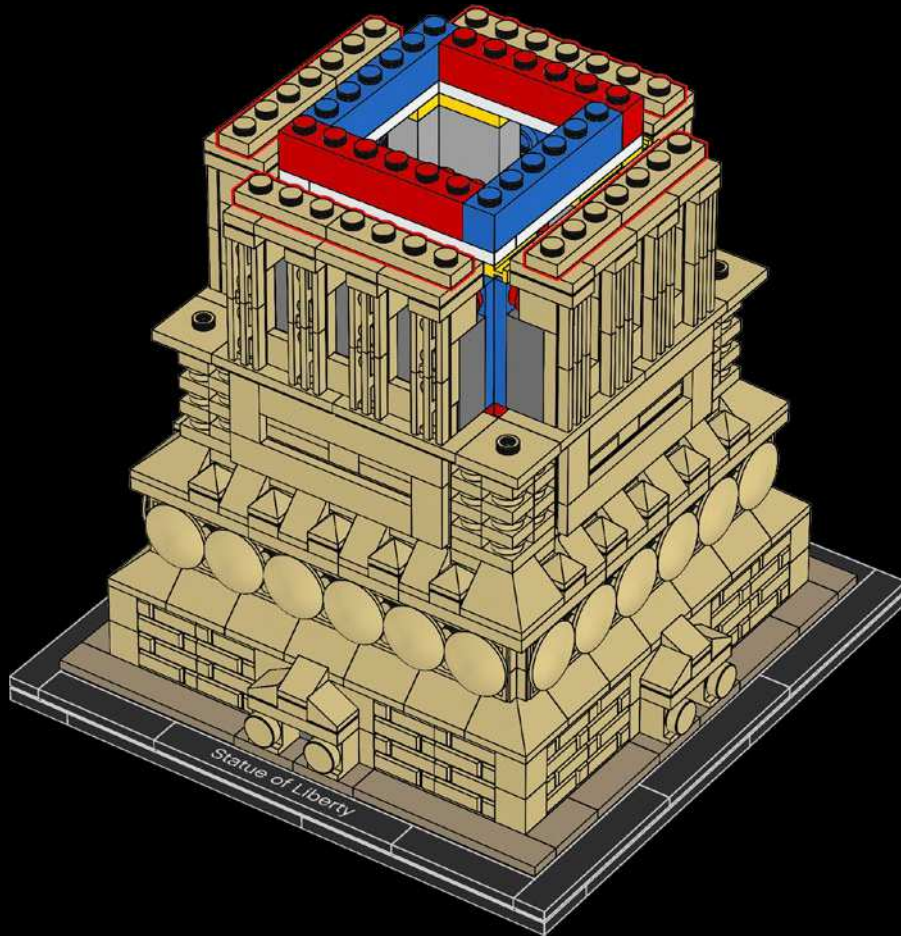

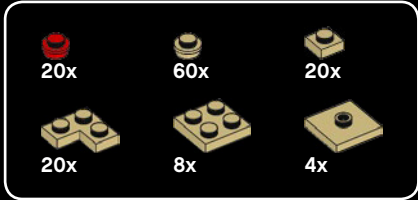

39

1

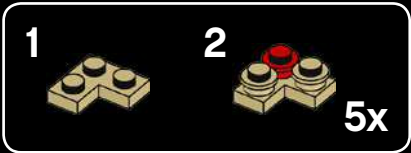

2



3



4



4x

In high winds of 50 mph (80 kph) or more, the Statue can sway by up to 3 in. (7.6 cm).

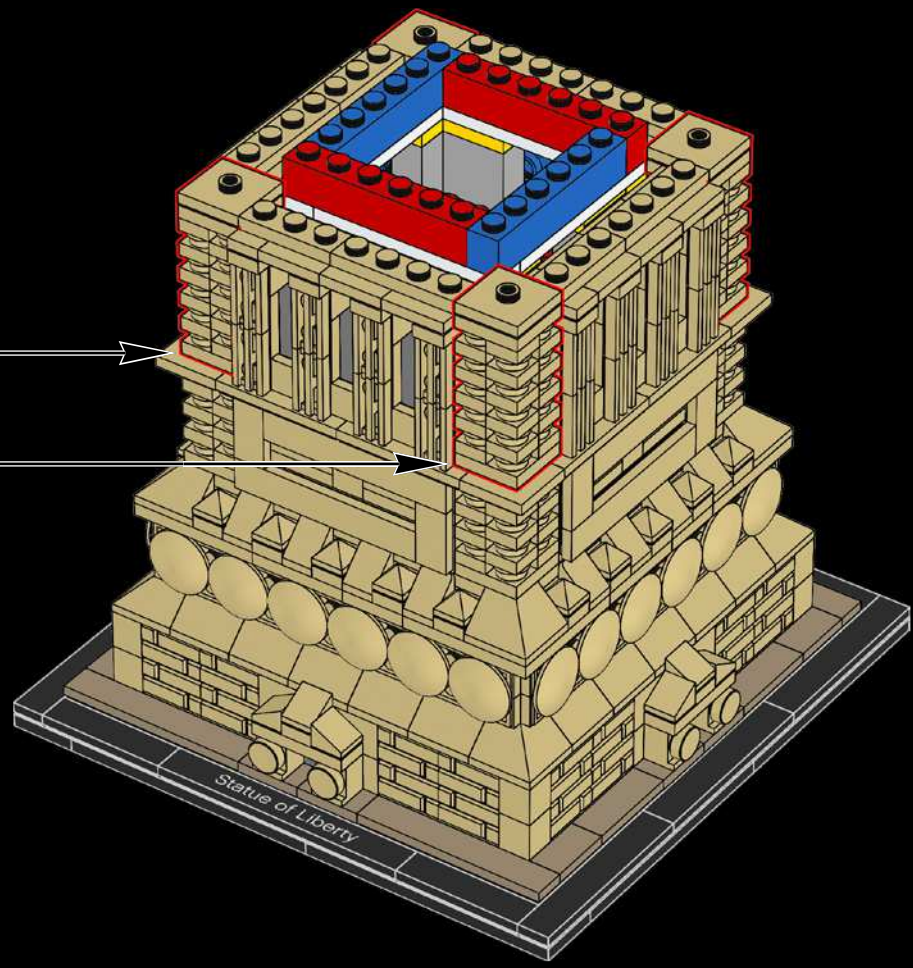

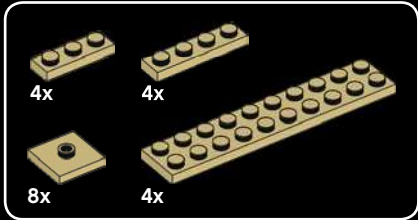
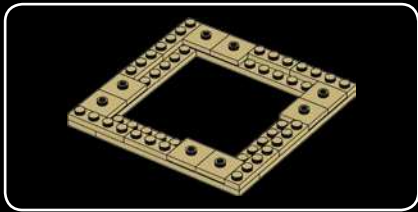

40

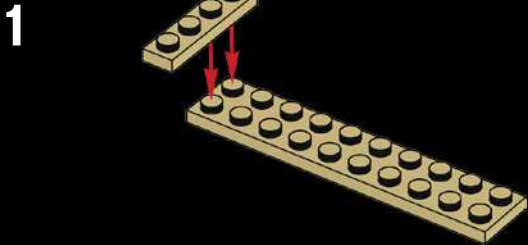

2

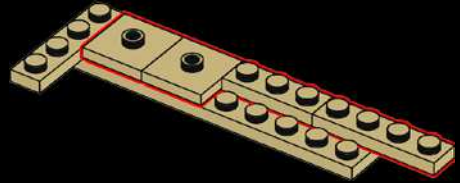

3

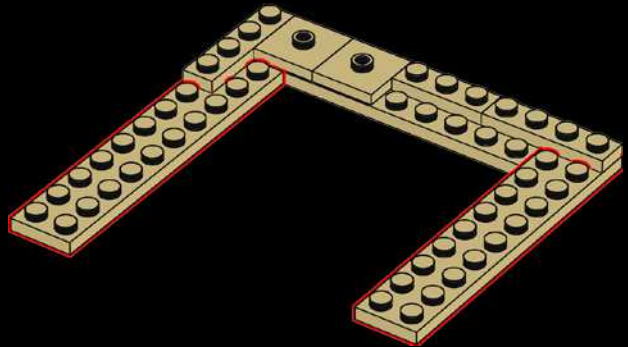

4

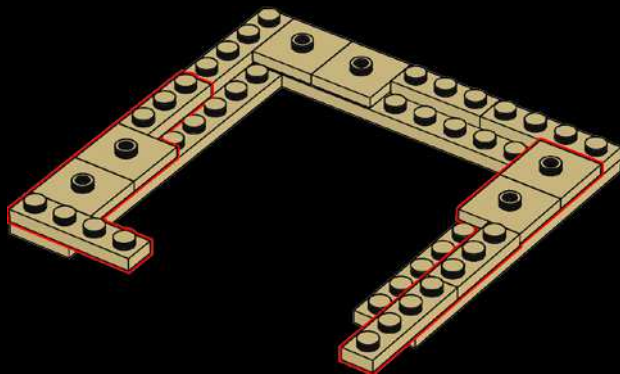

1

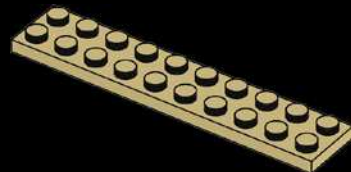

2

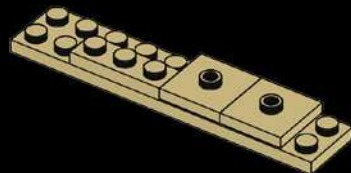

5

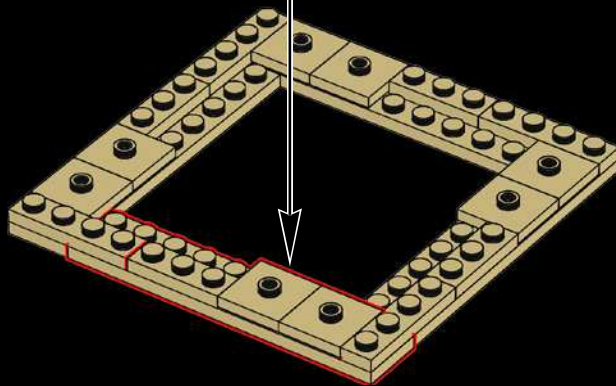

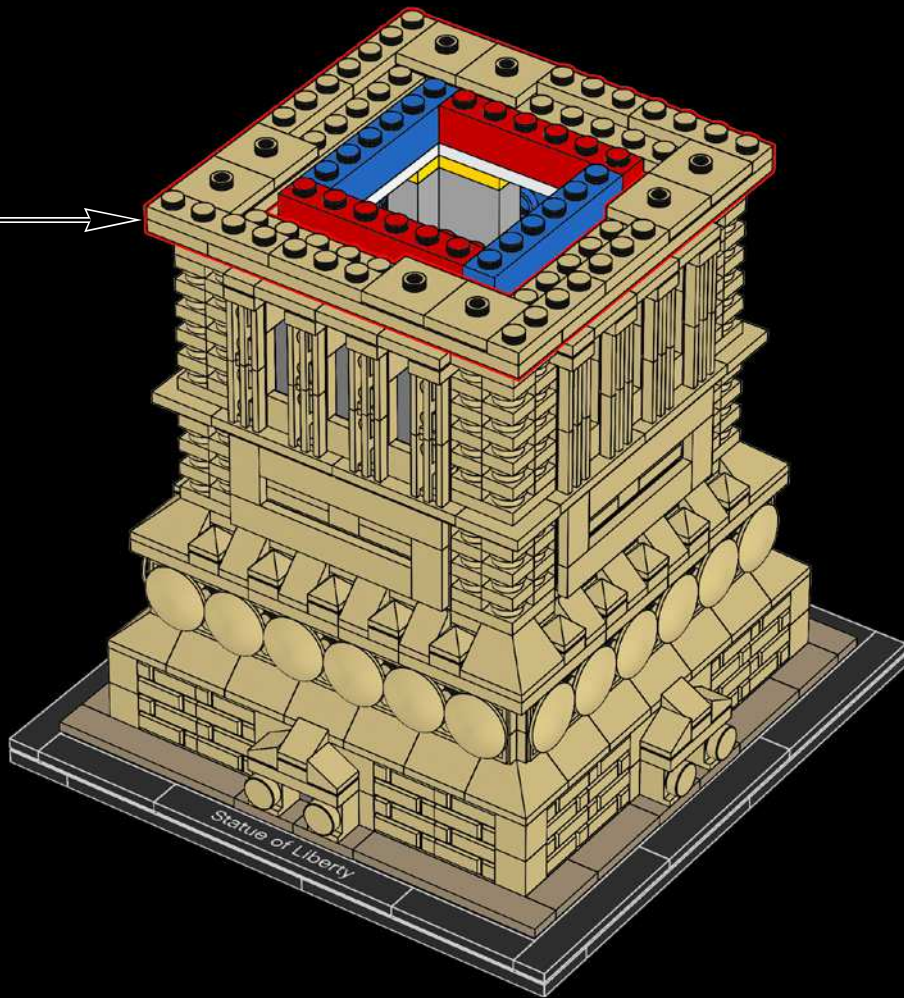

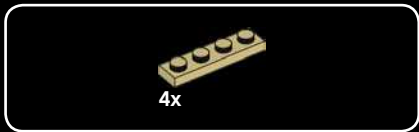

41

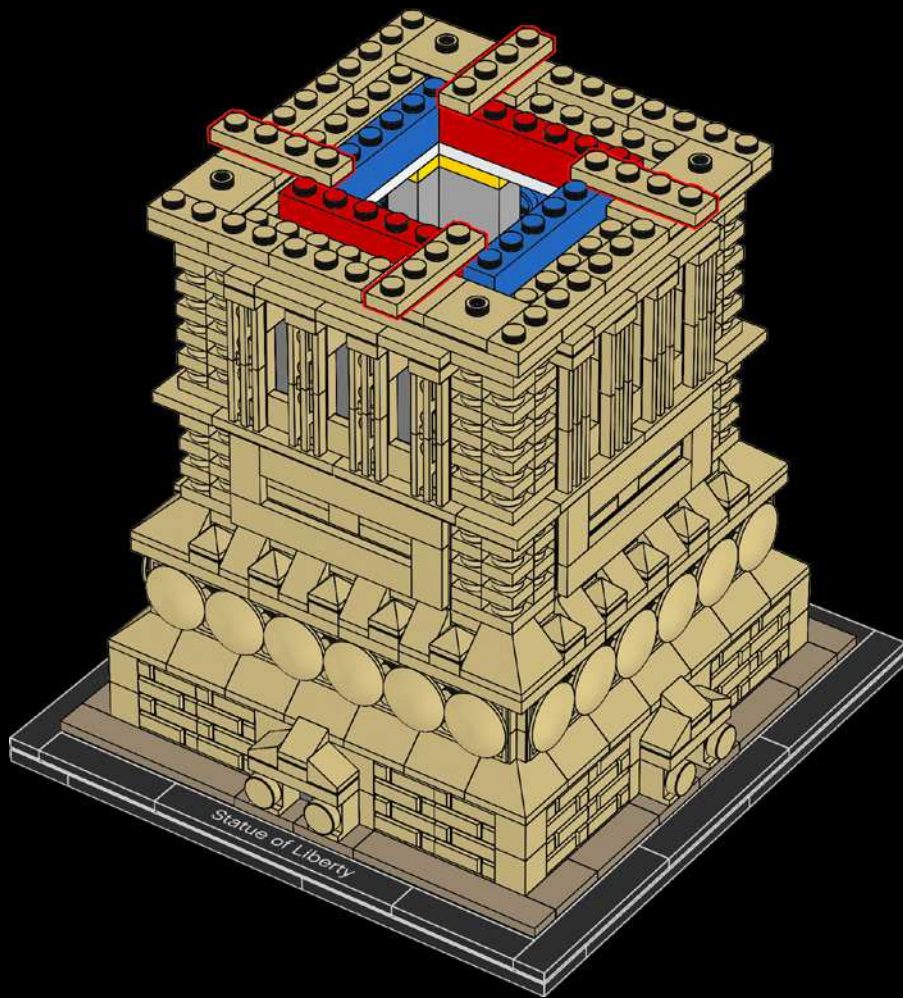

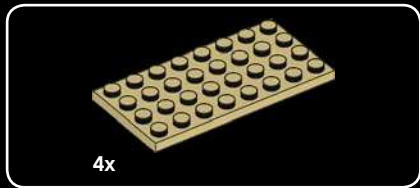

42

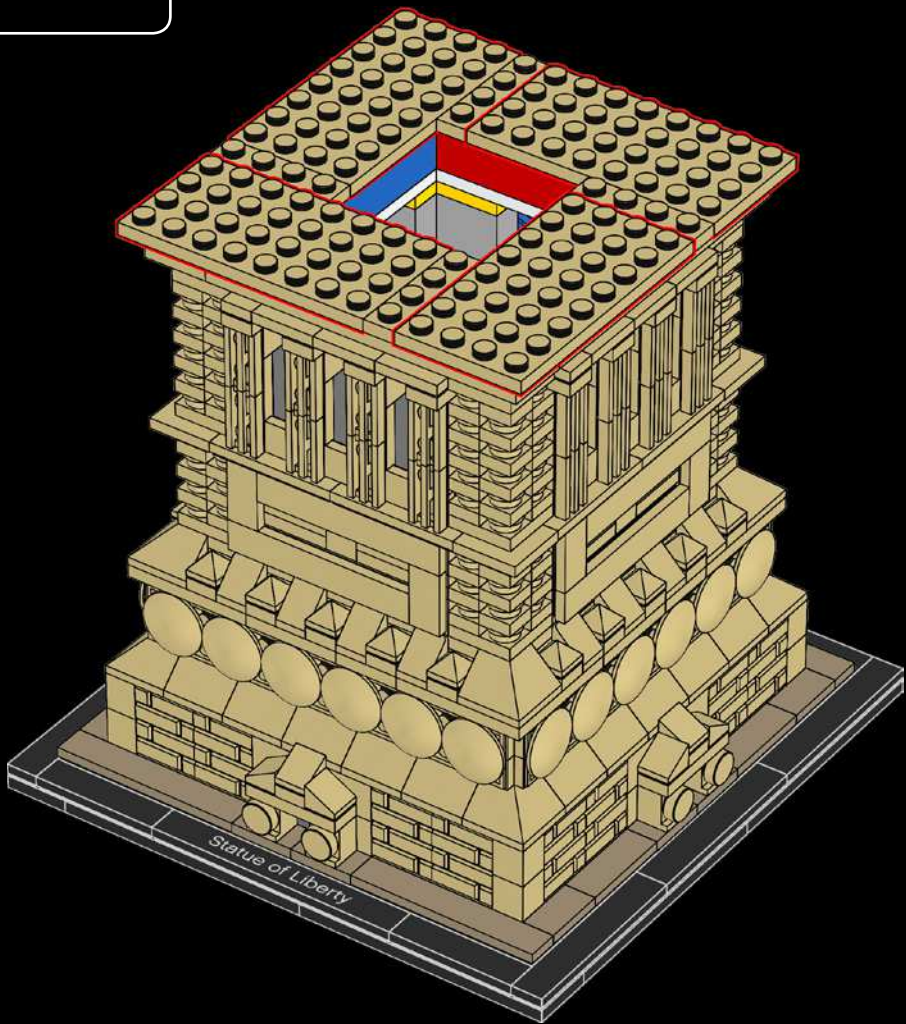

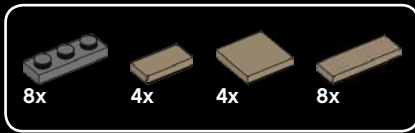

43





16x



16x

44

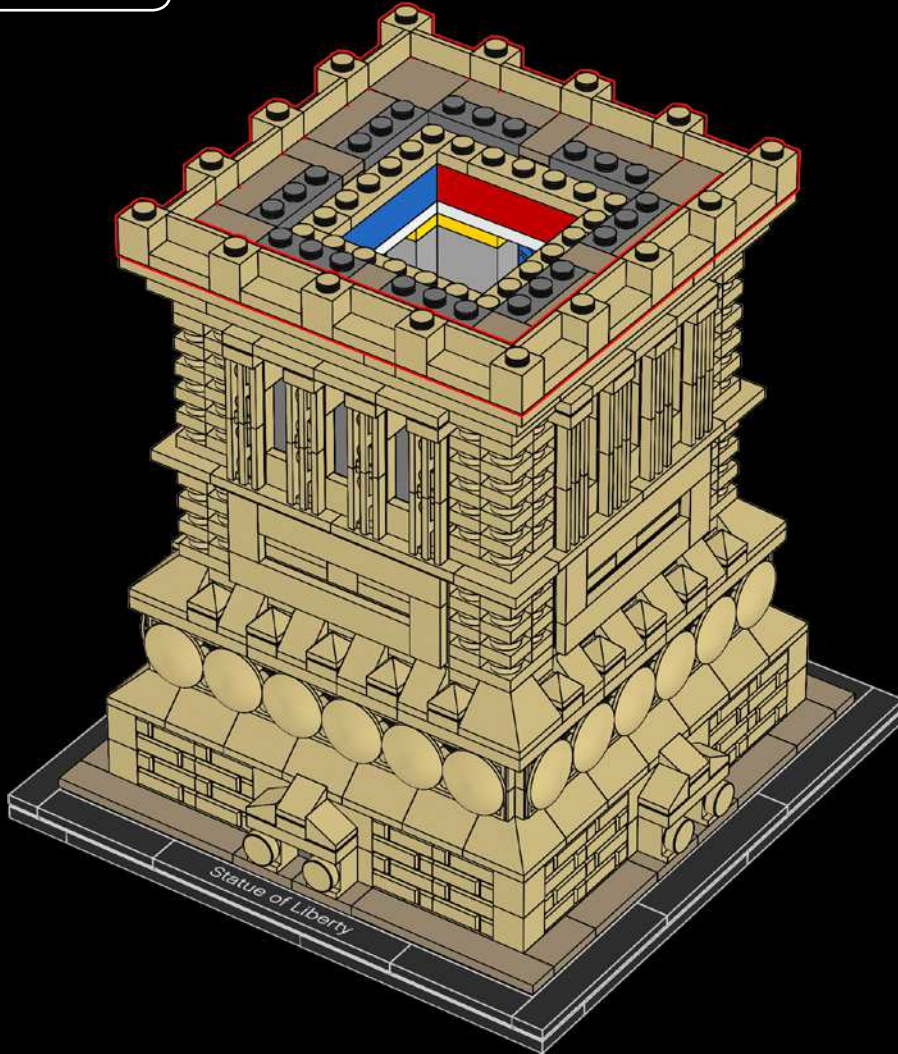



45

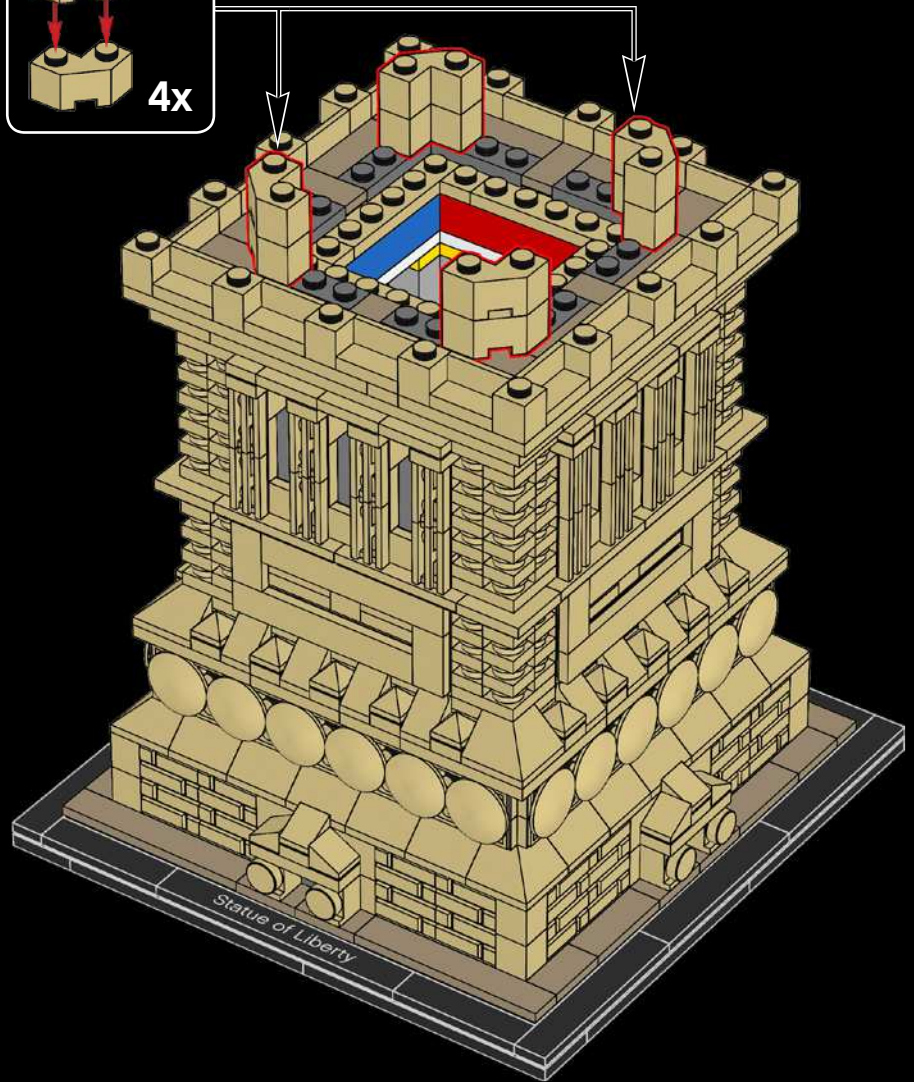
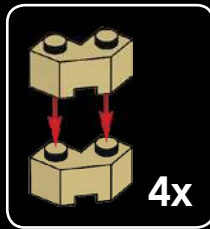



16x

46



8x

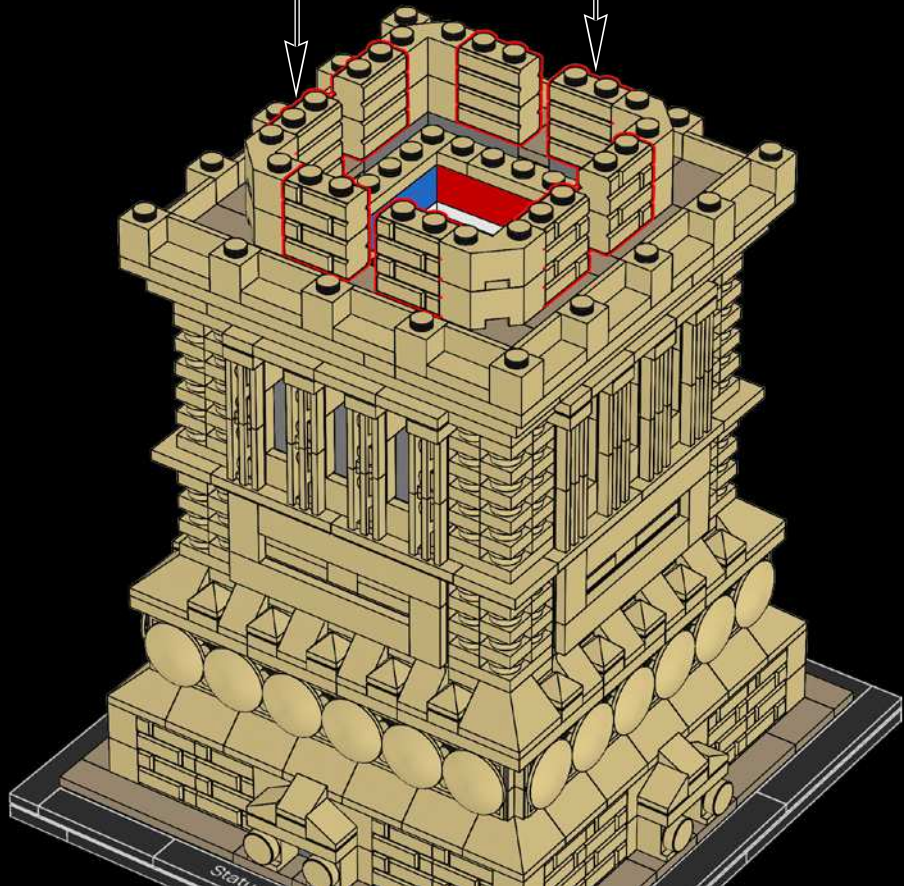

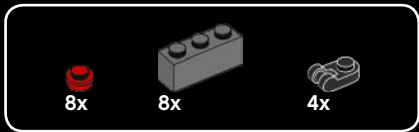

47

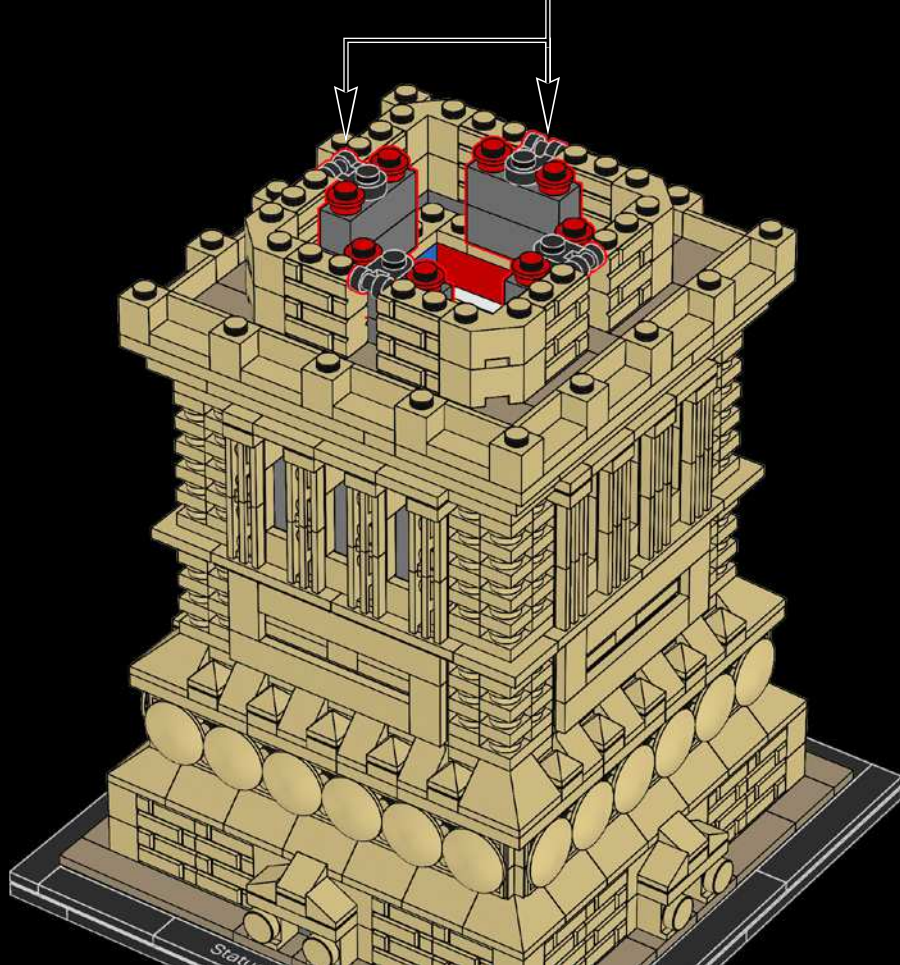
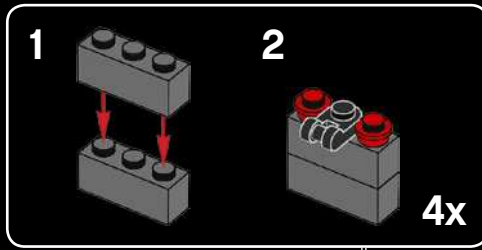

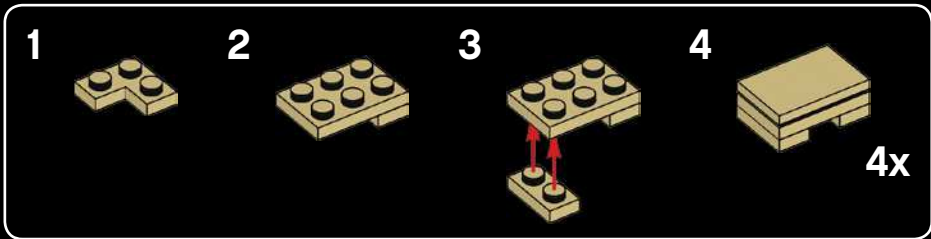
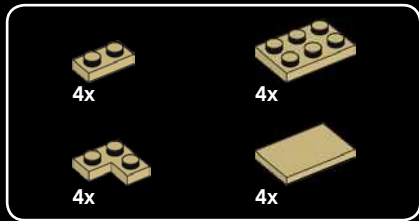

48

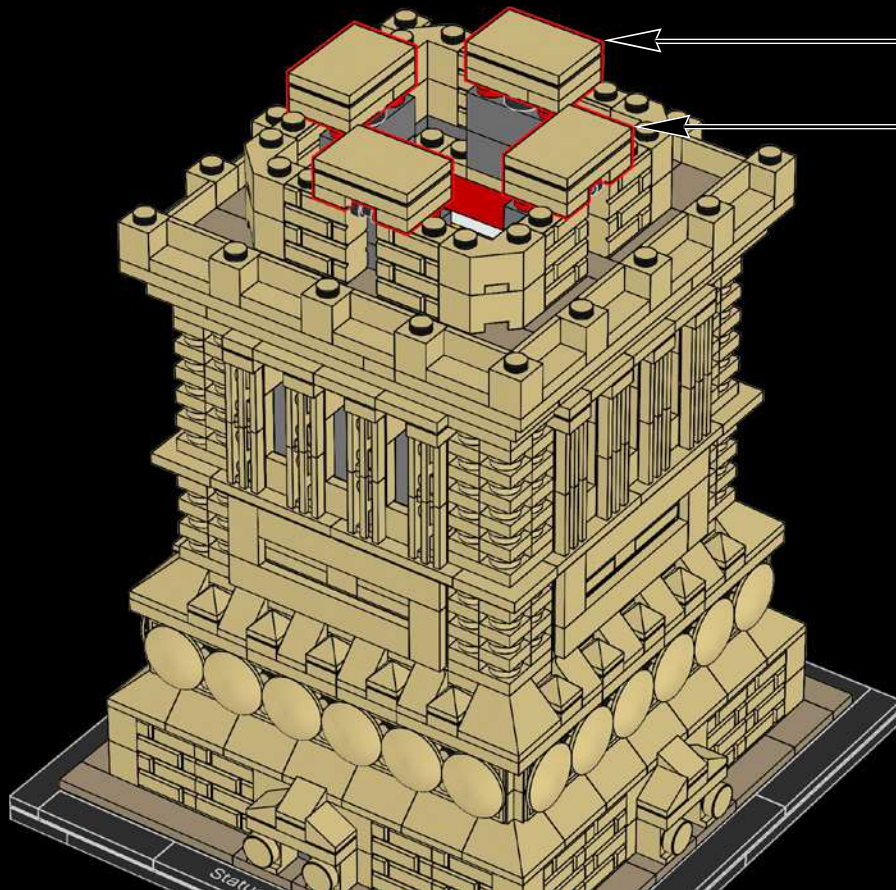

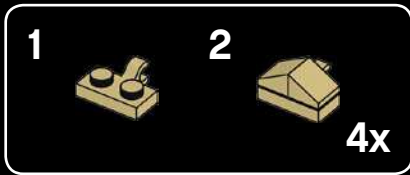

49

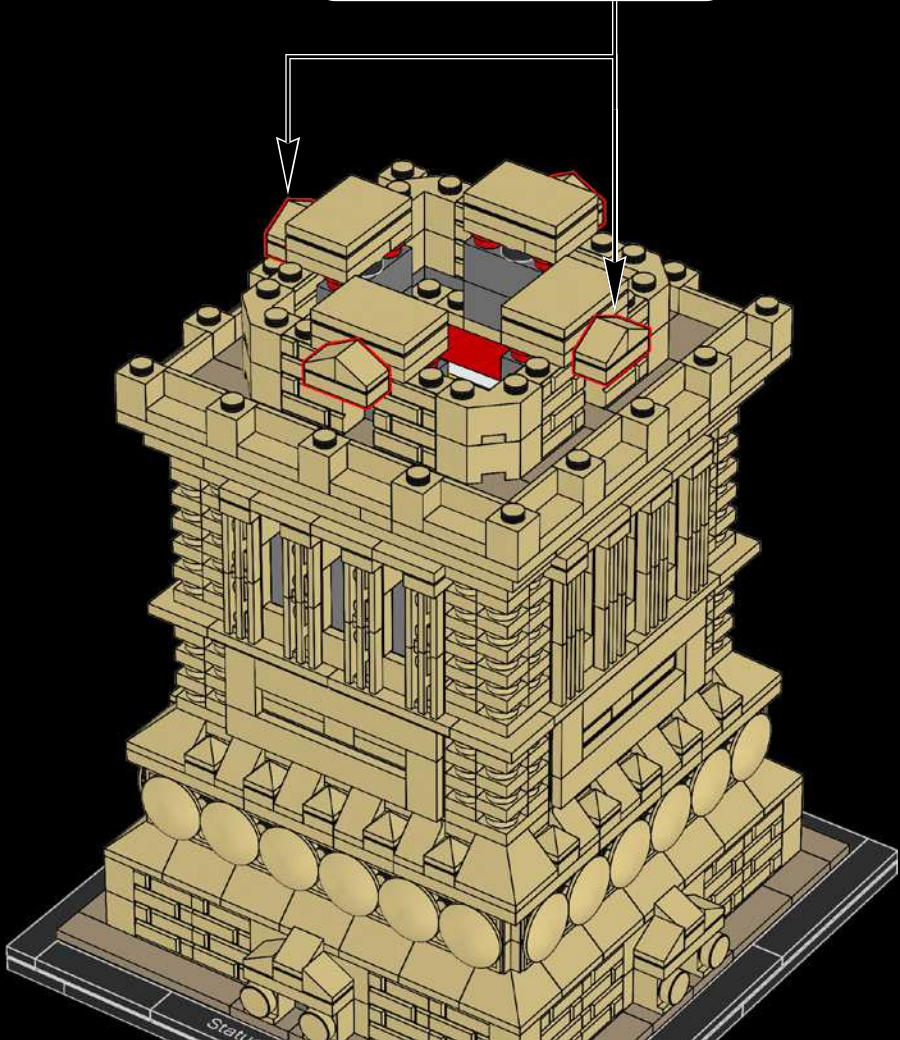



8x



4x

50

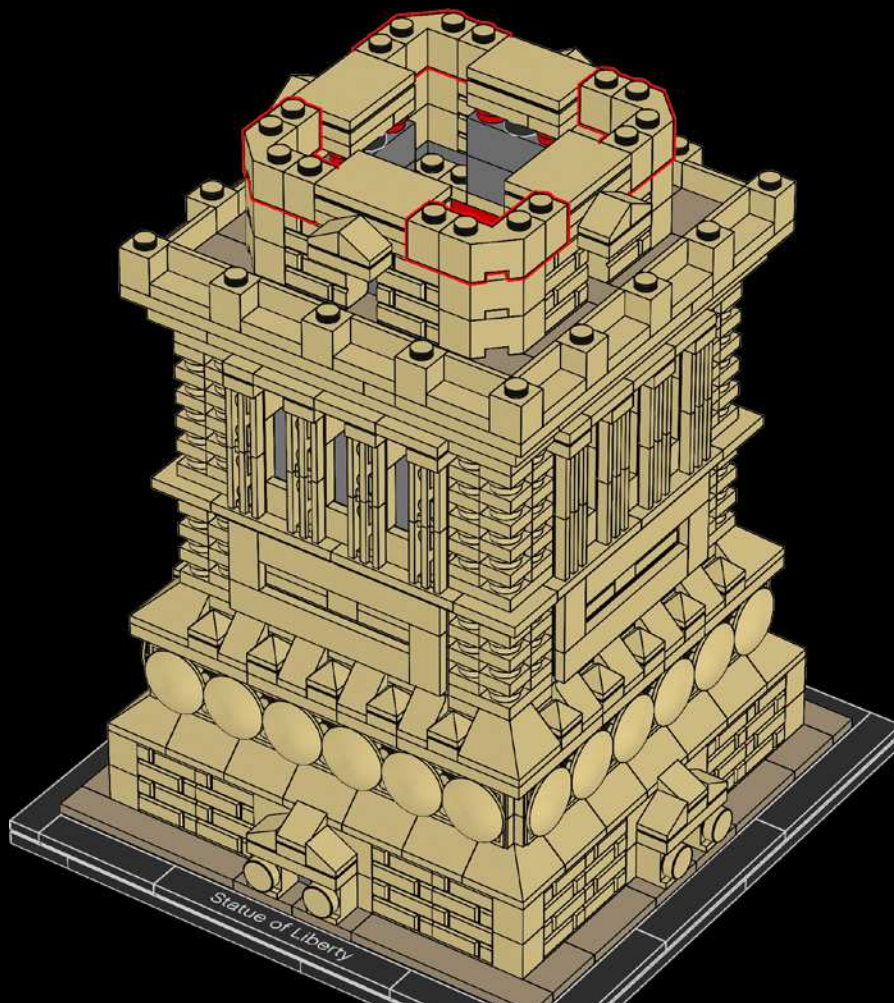

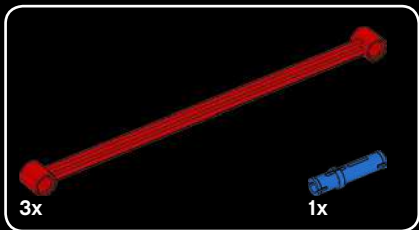

51

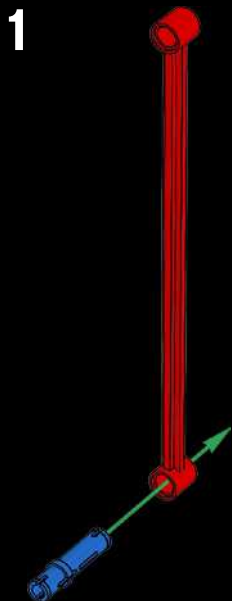

2



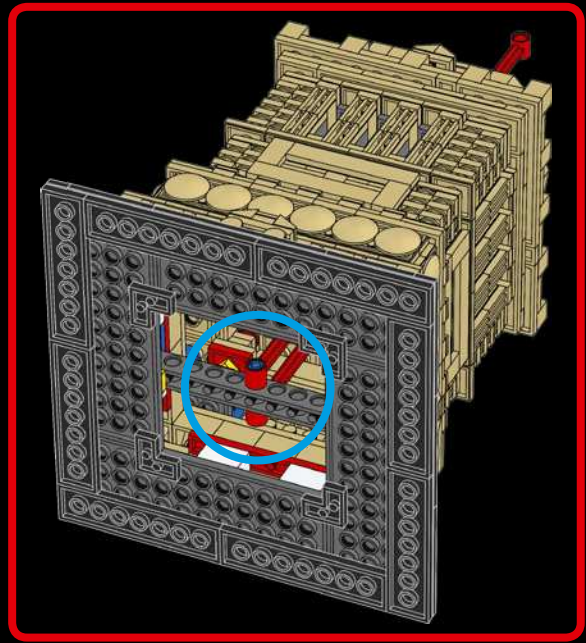
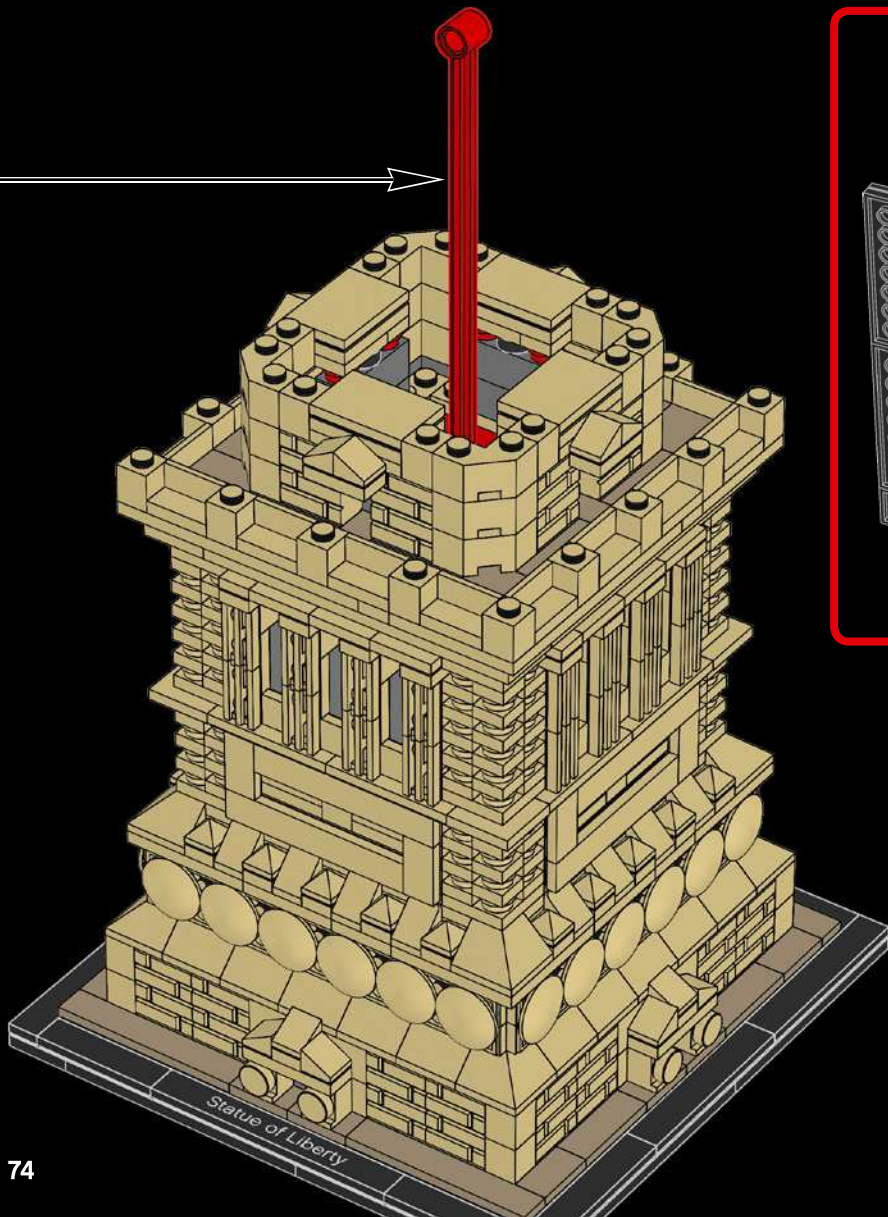

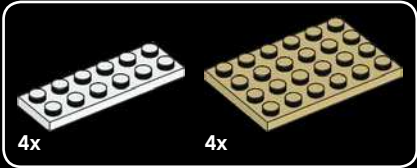
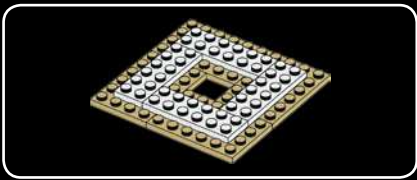

52

1

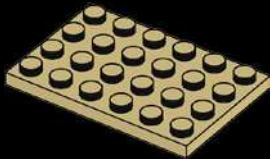

2

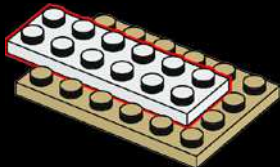

3

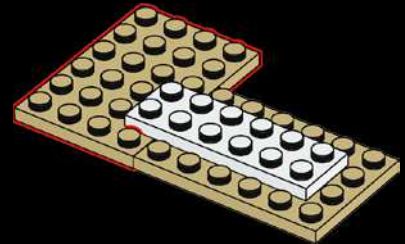

4

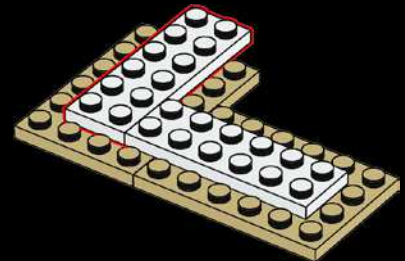

5

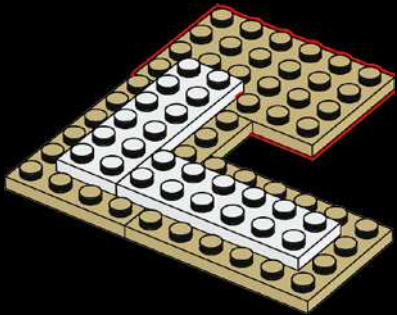

6

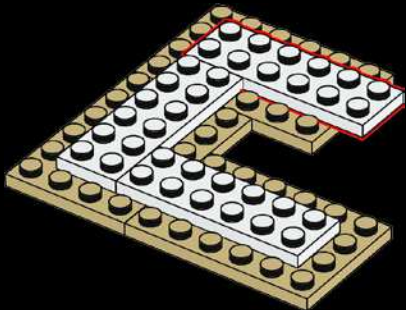

7

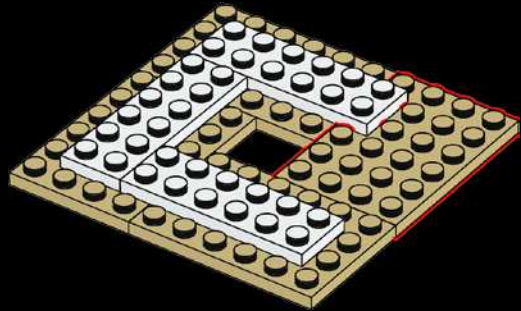

8

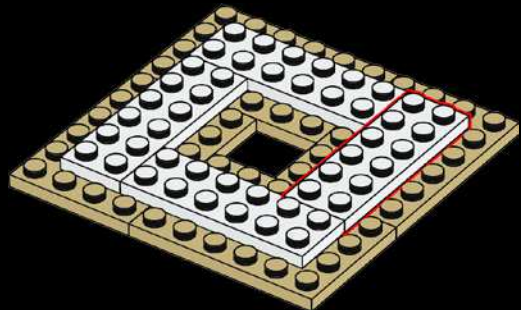

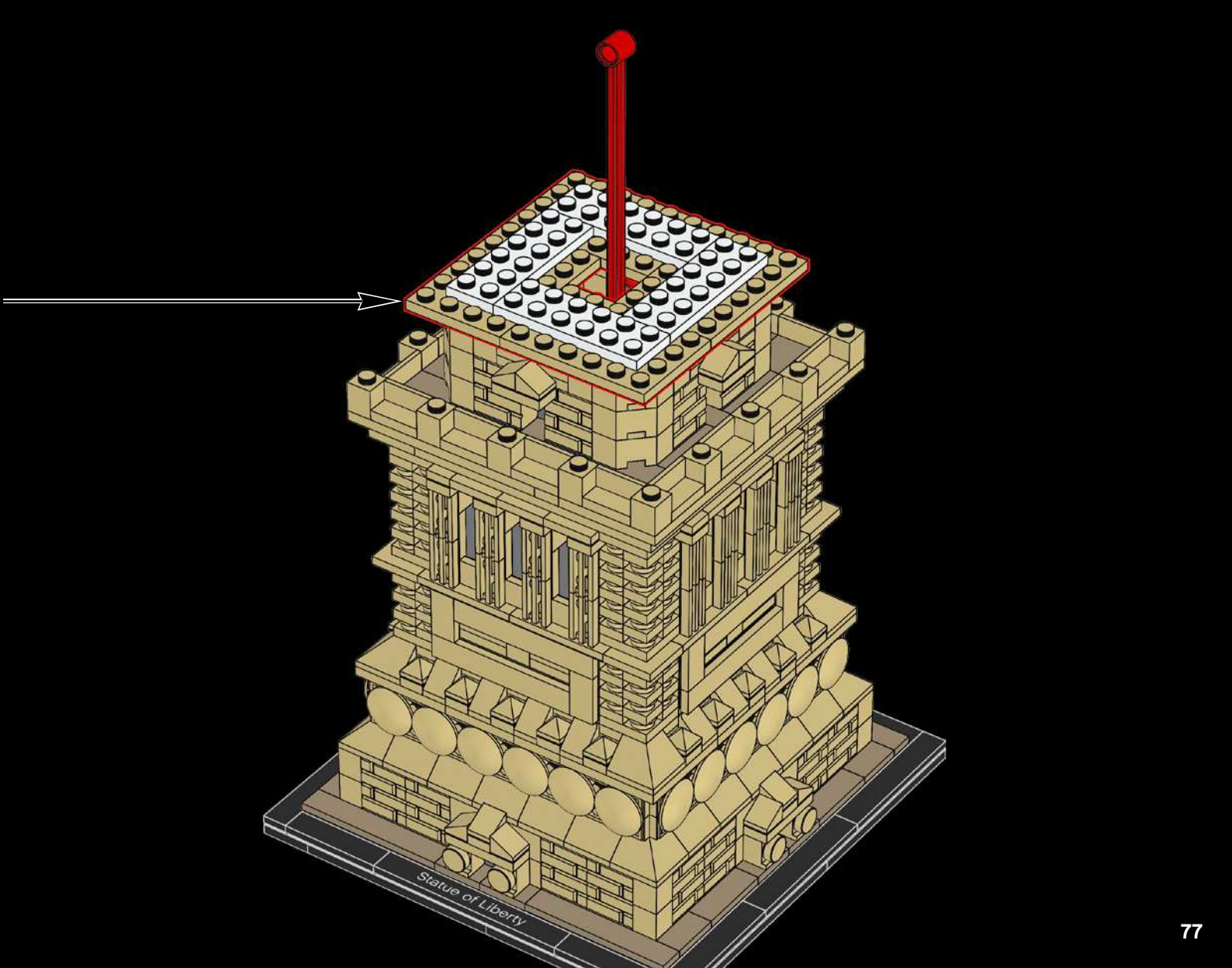

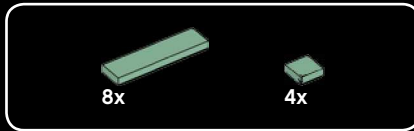
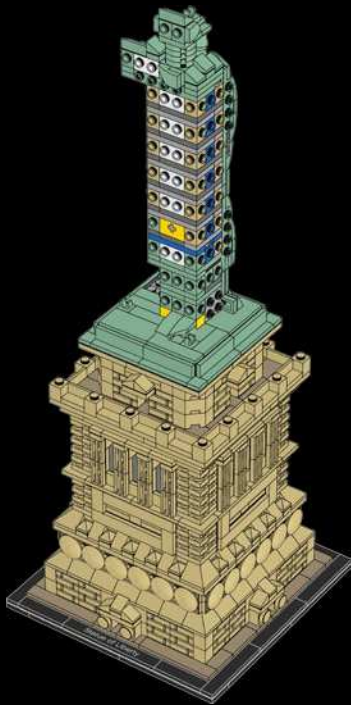
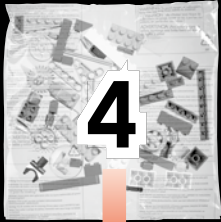

53

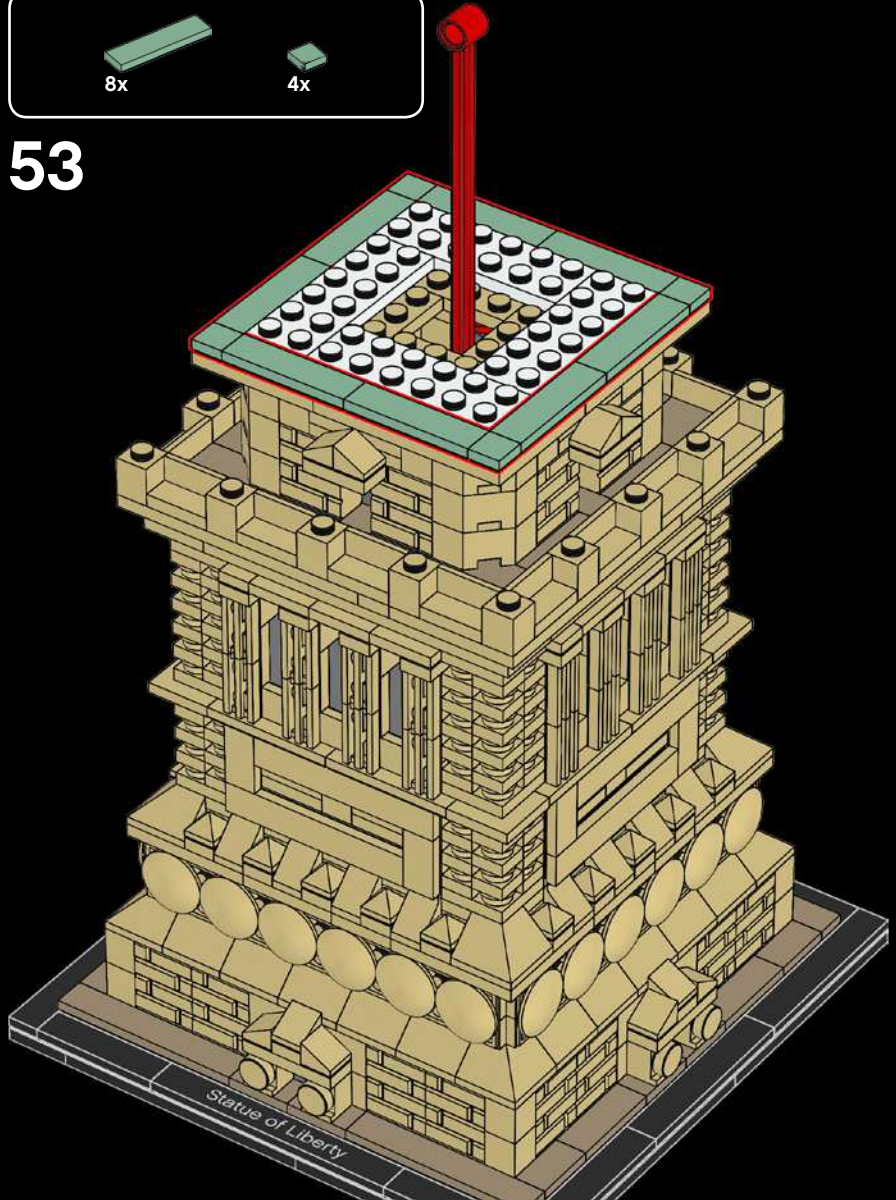

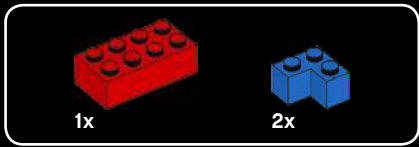

54

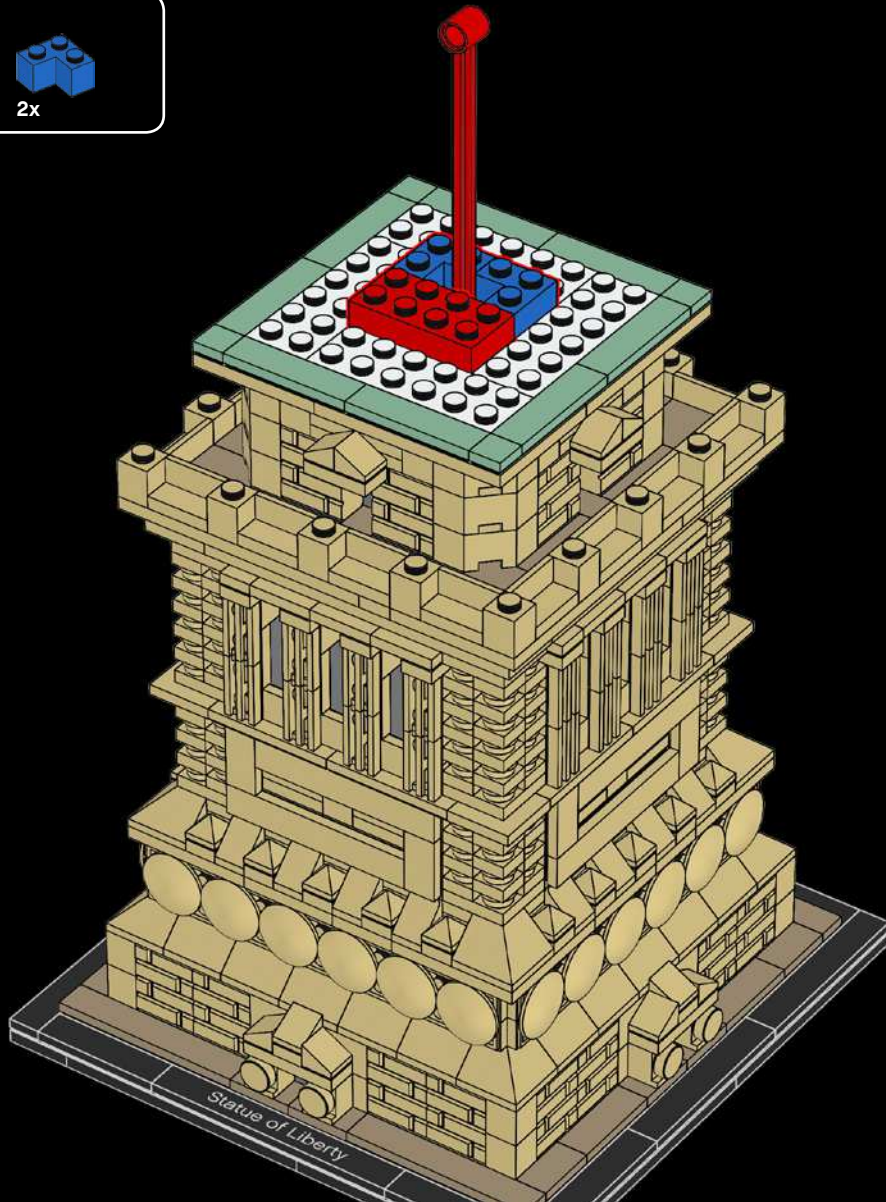

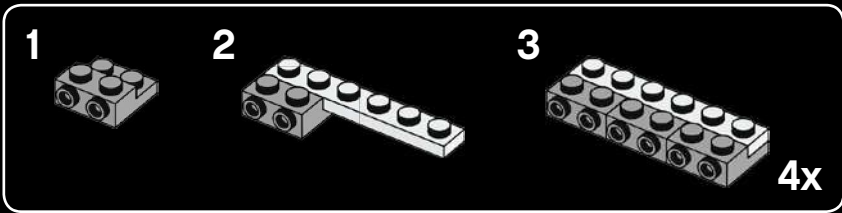
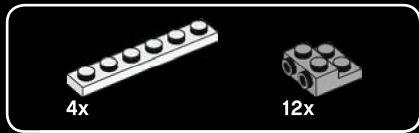

55

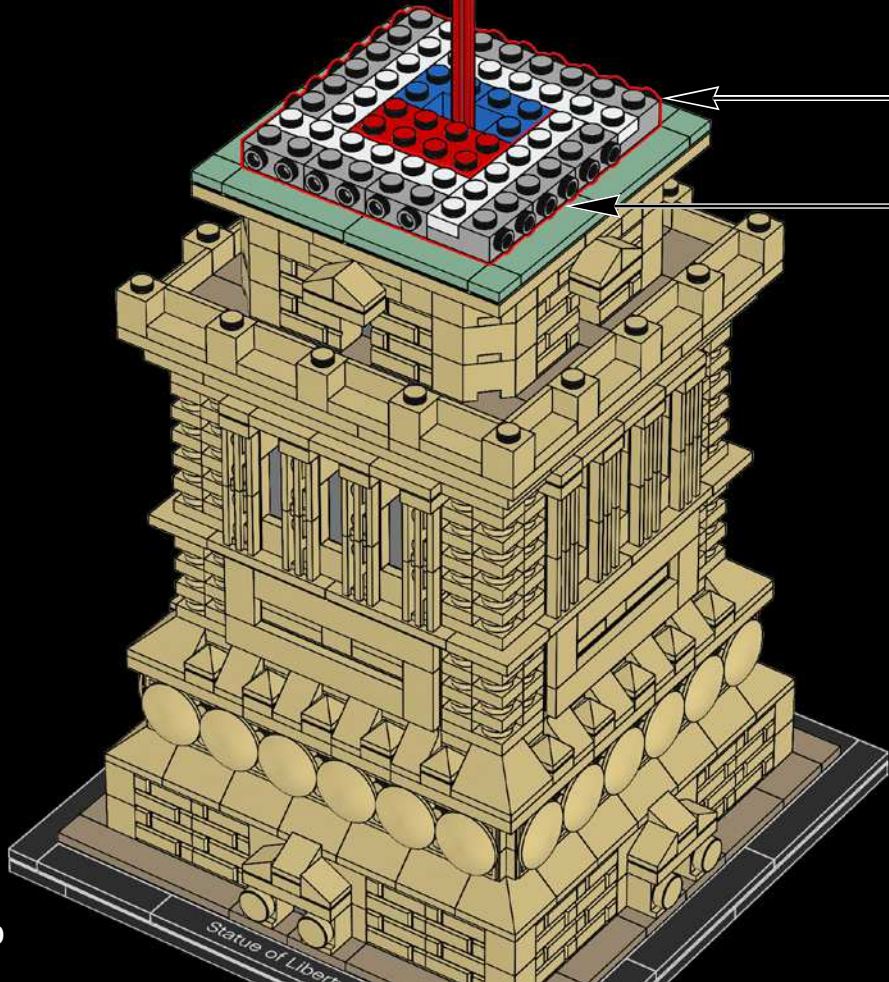

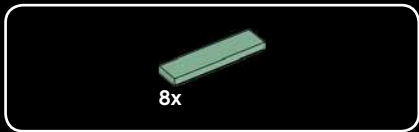

56

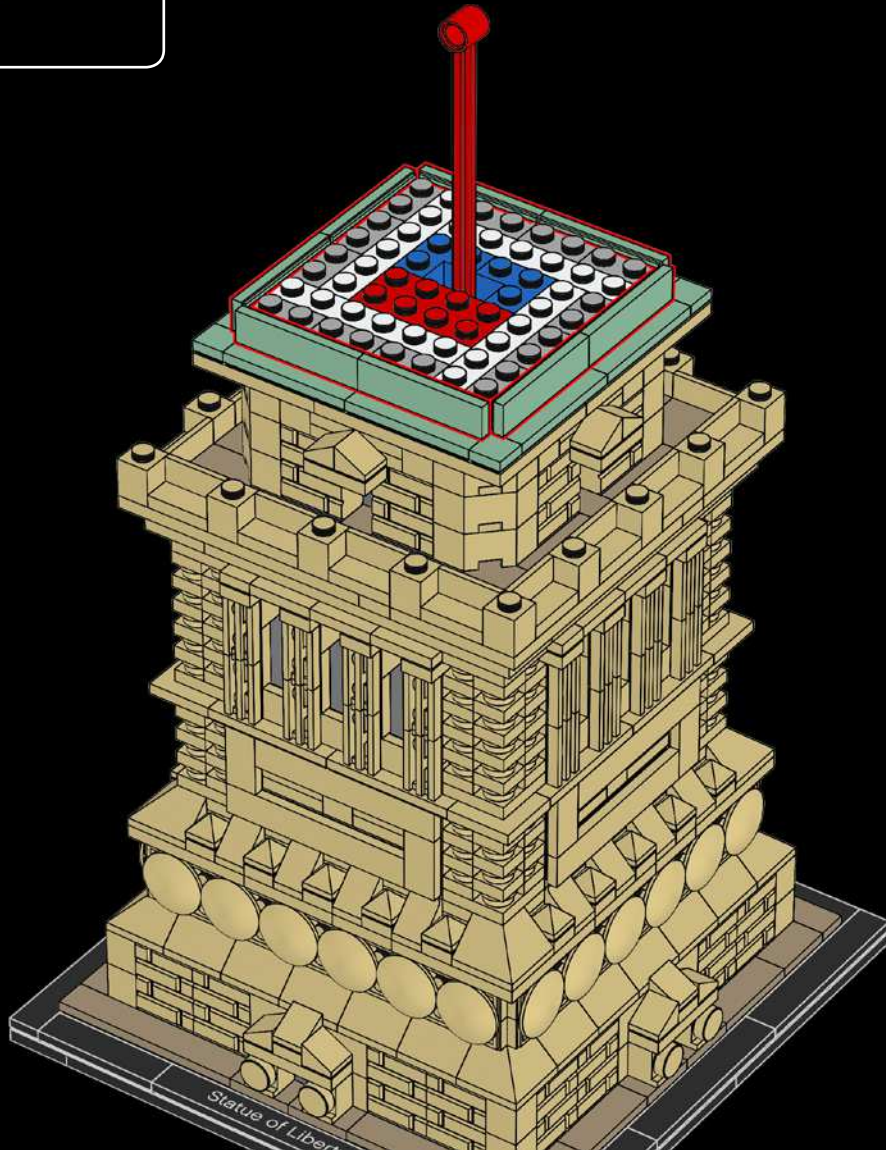

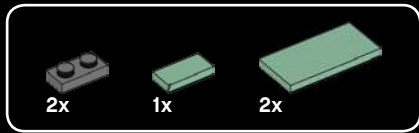

57

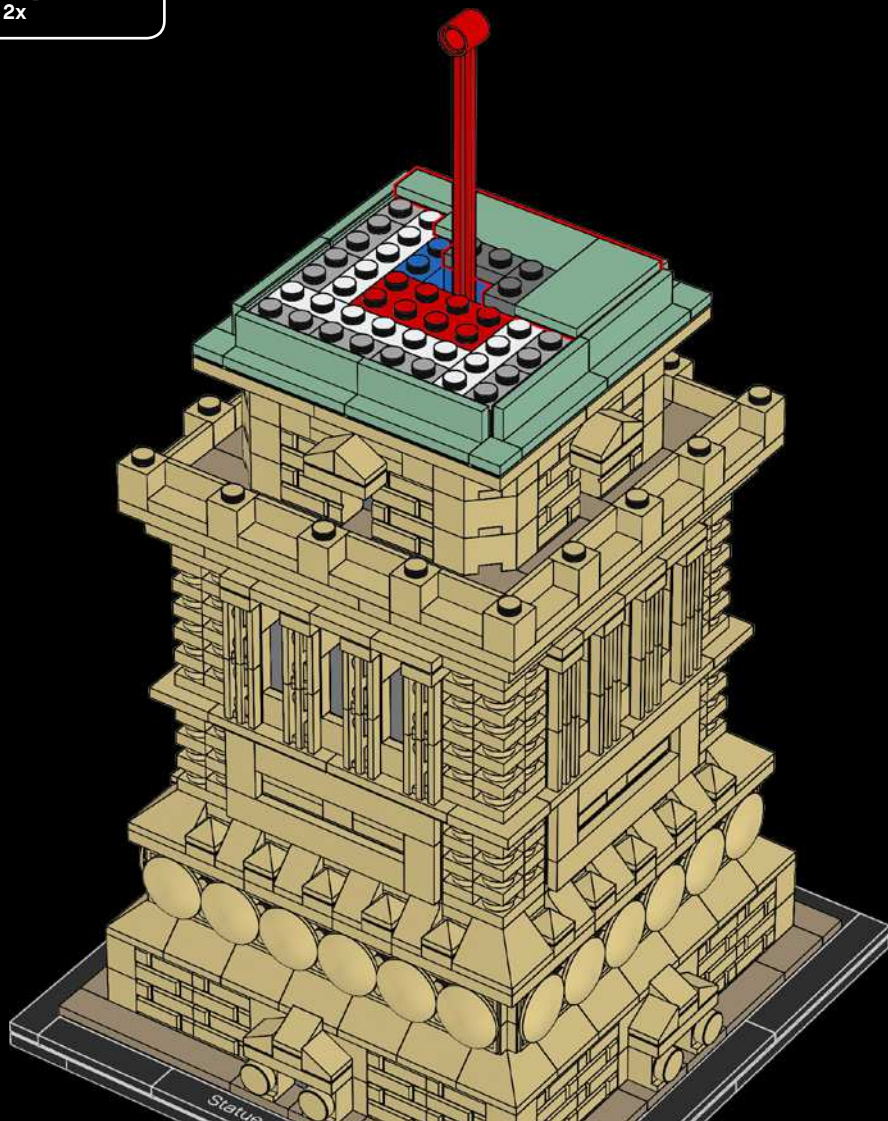

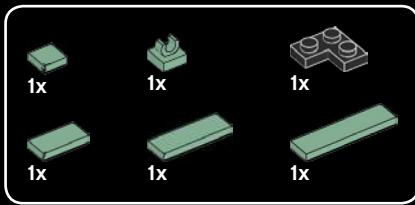

58

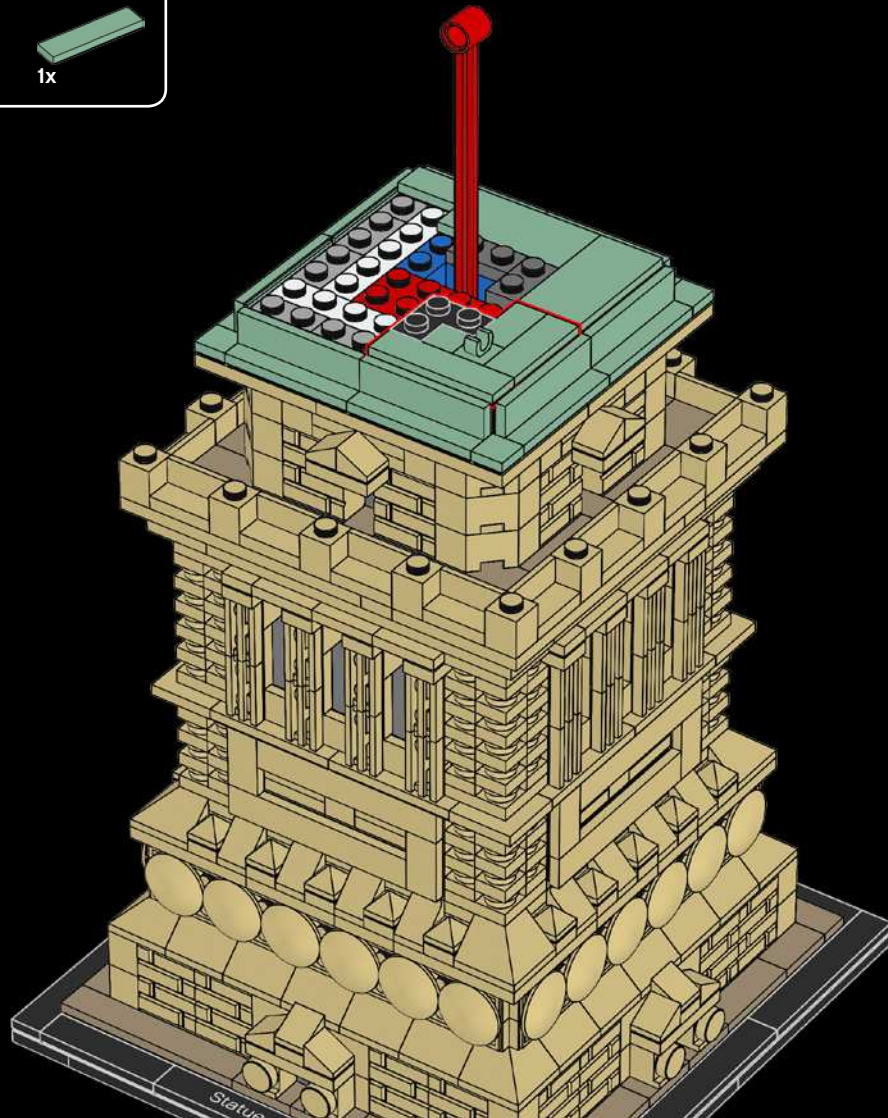

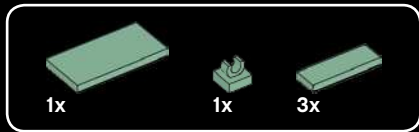

59

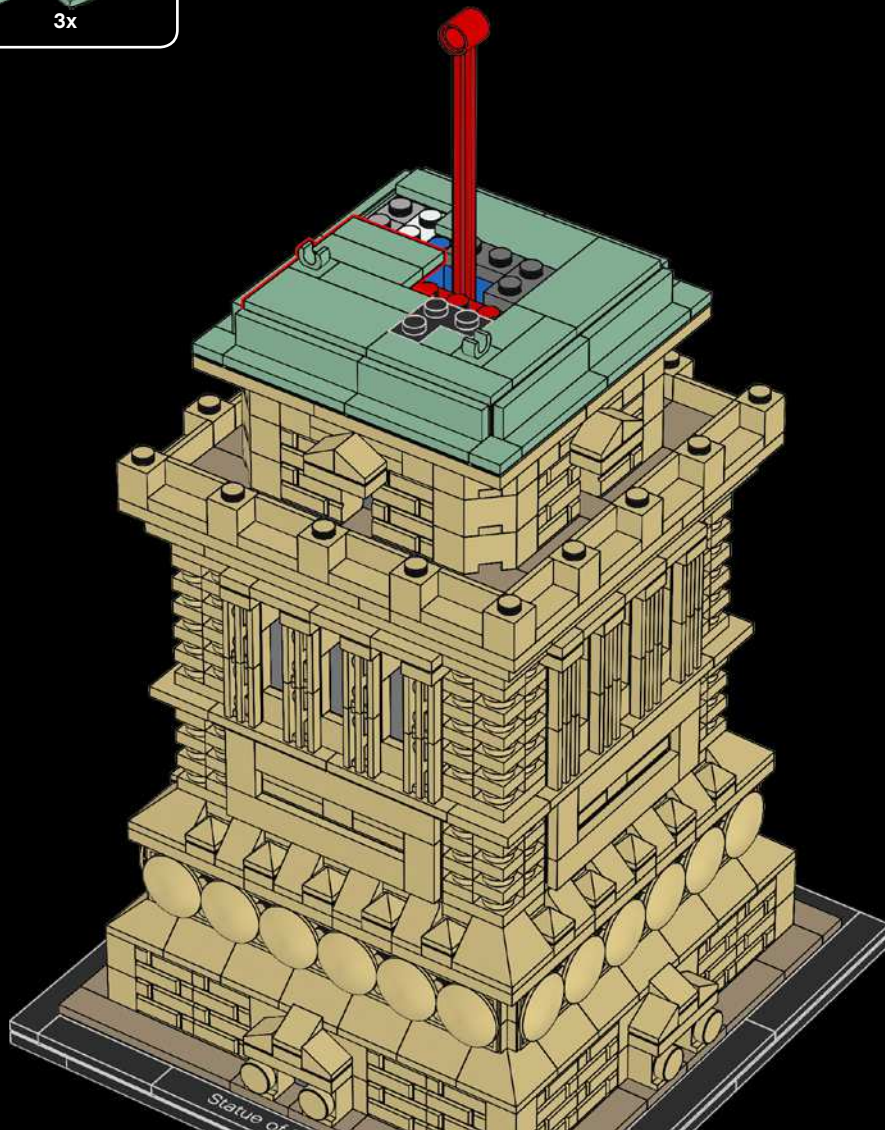

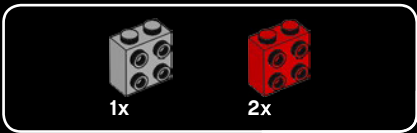

60

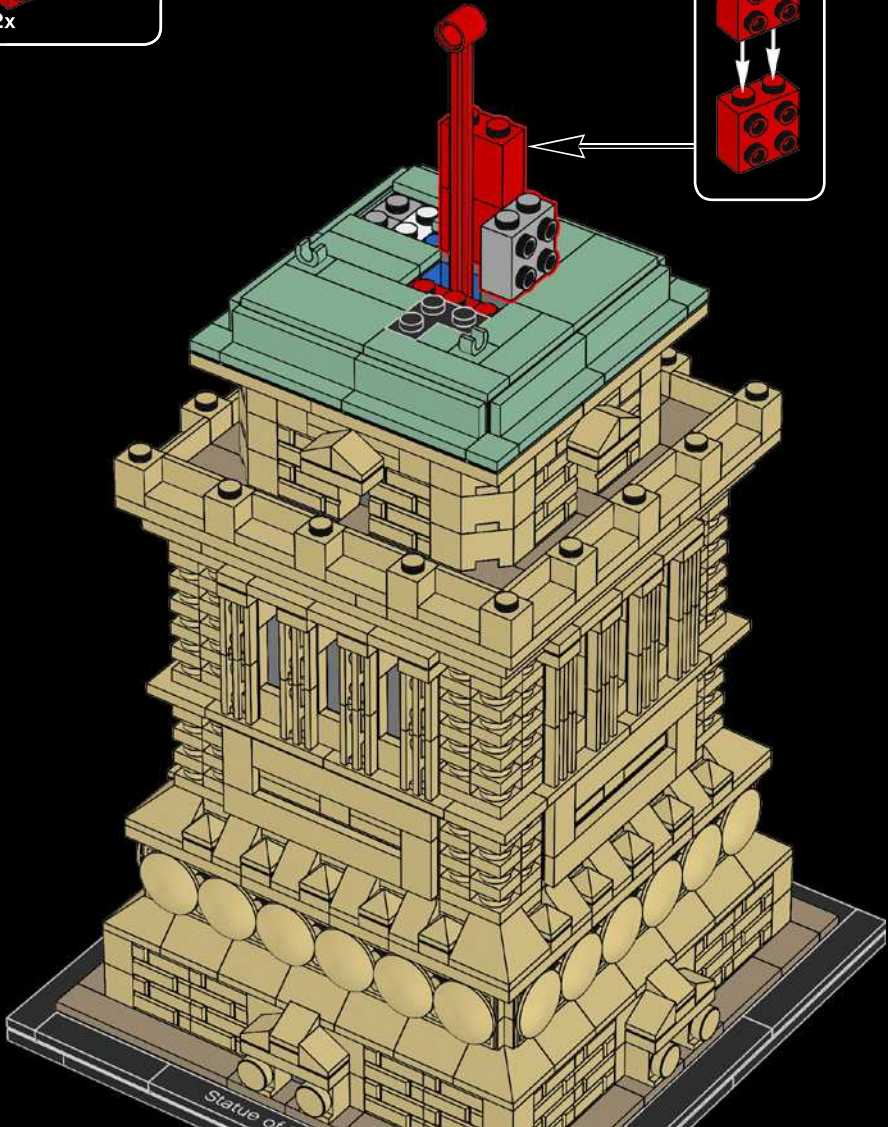
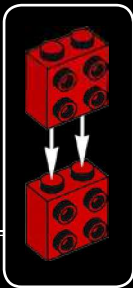

Statue of

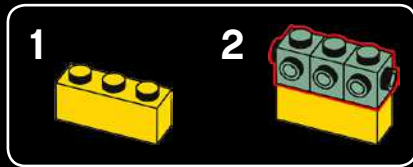
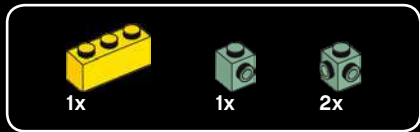

61

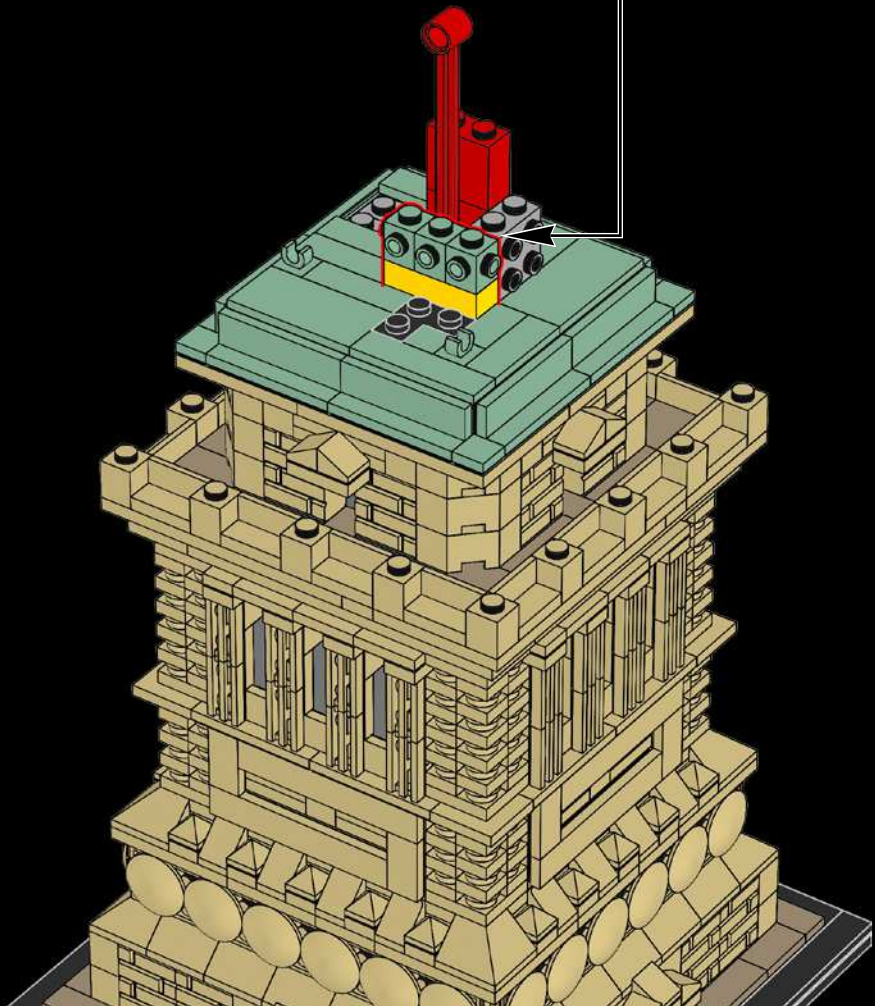



62

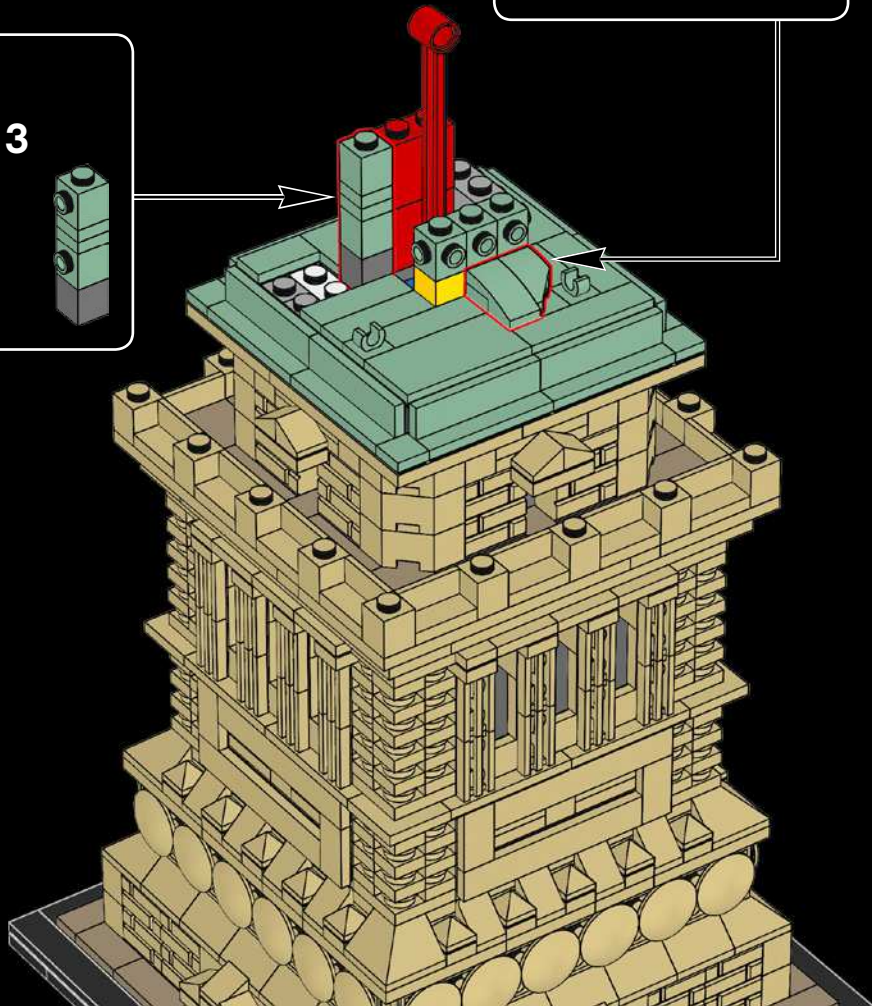
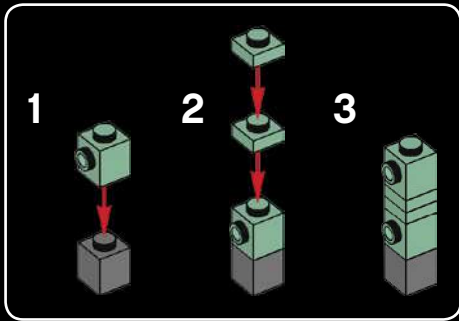
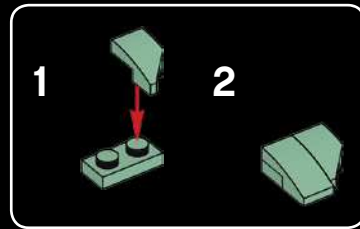



63

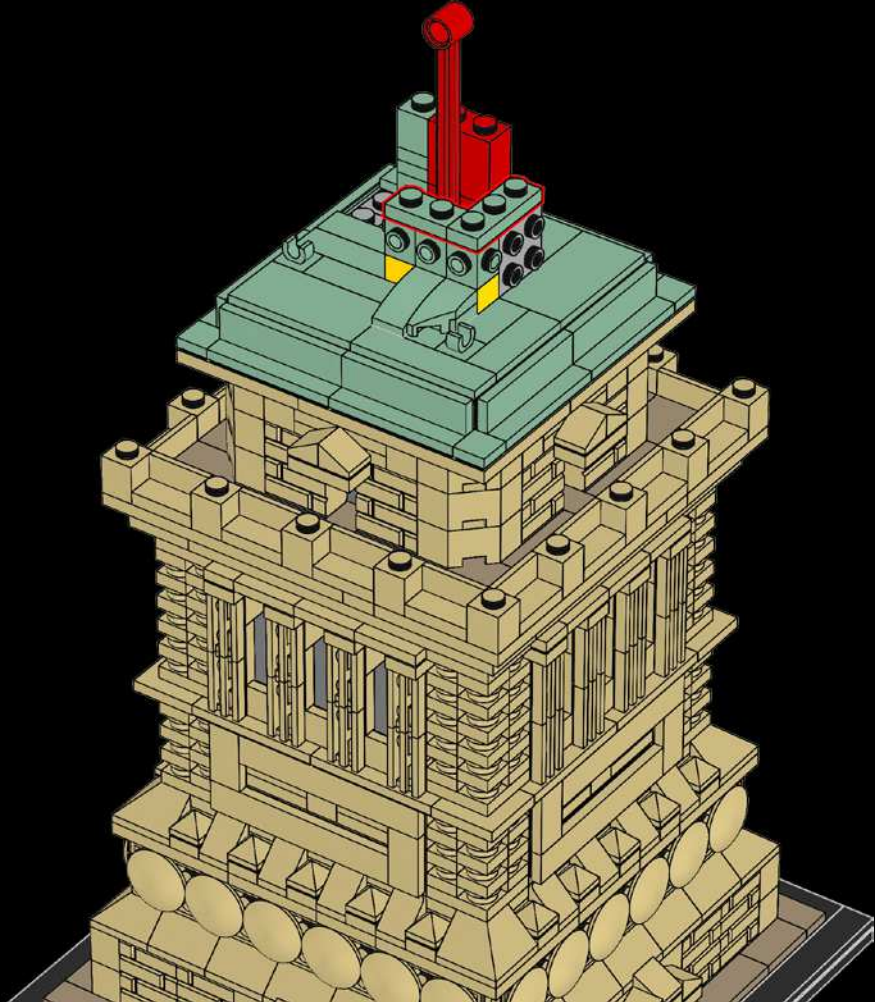

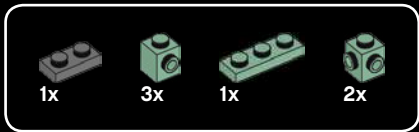

64

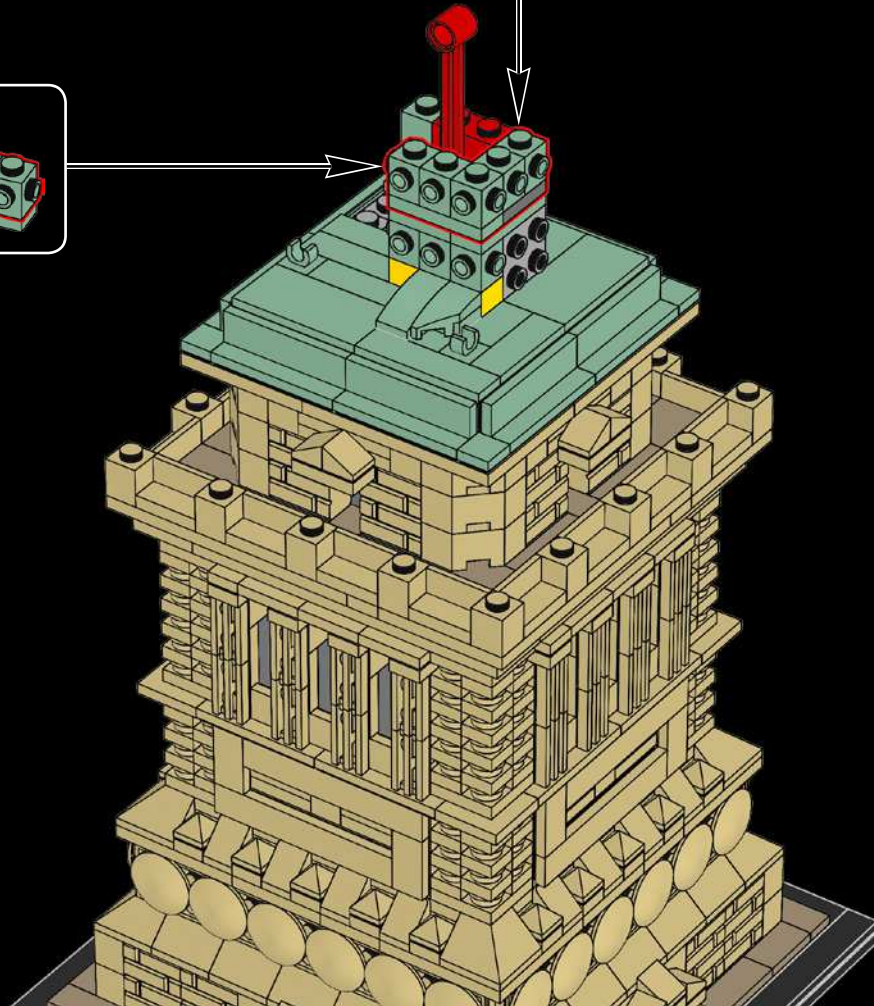
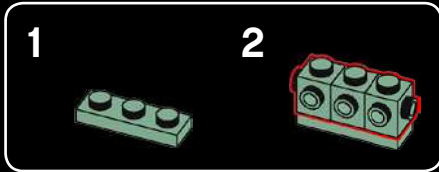
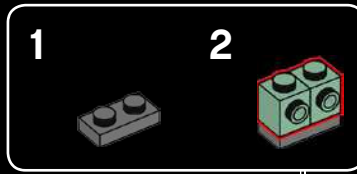



65

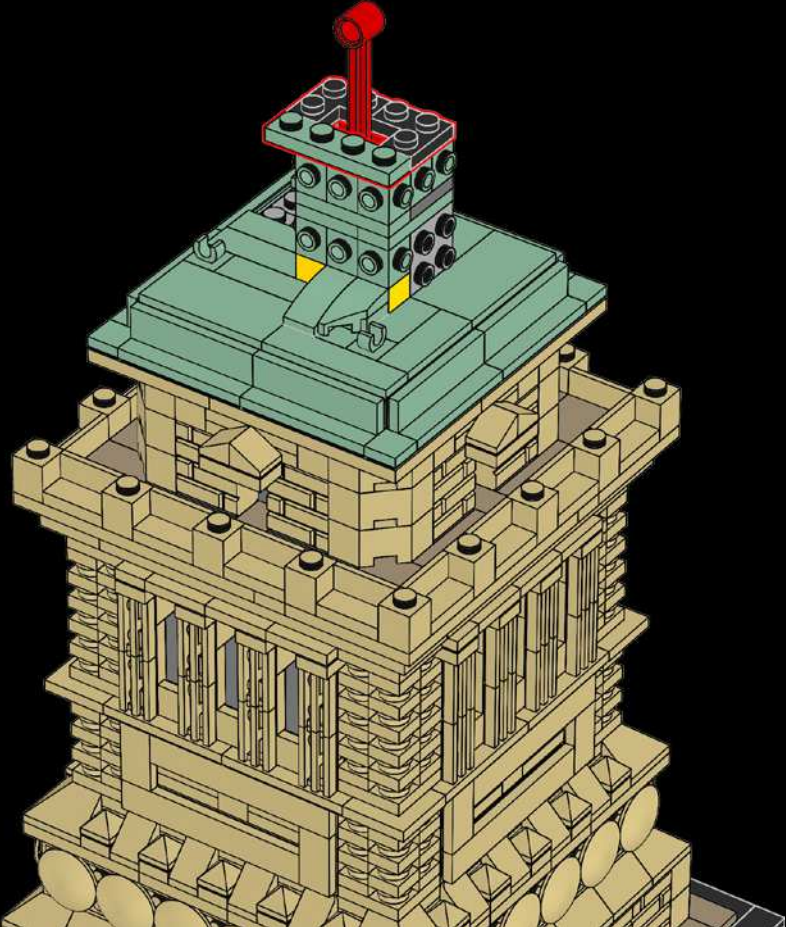



66

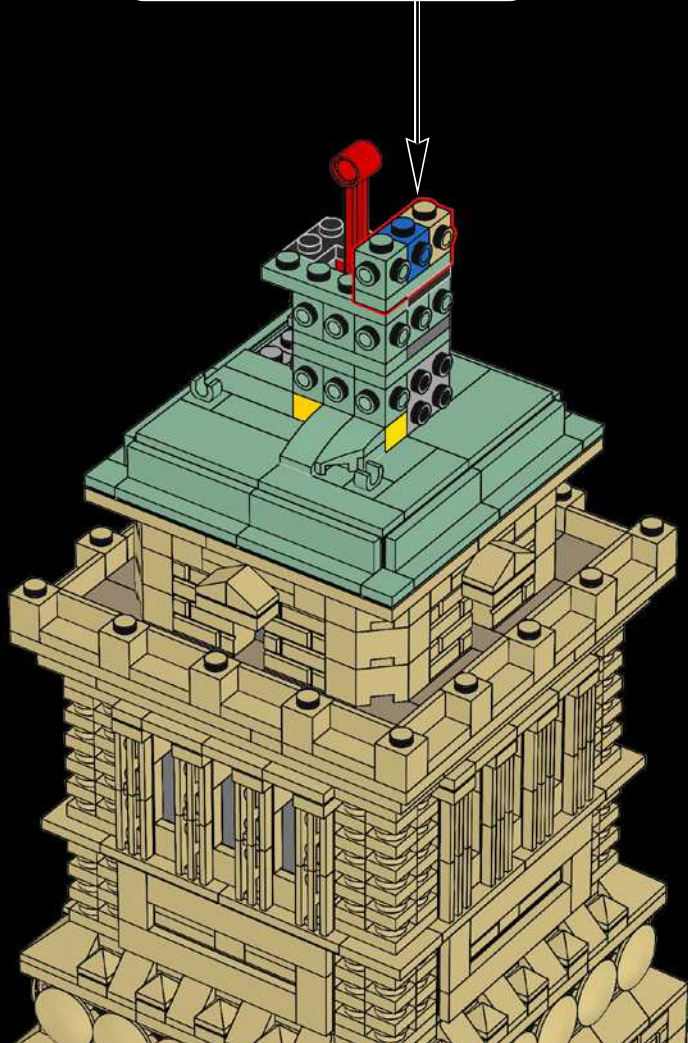
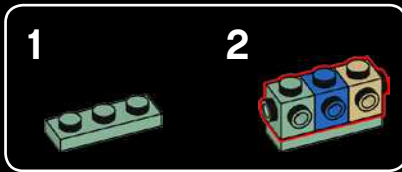



2x



1x

67

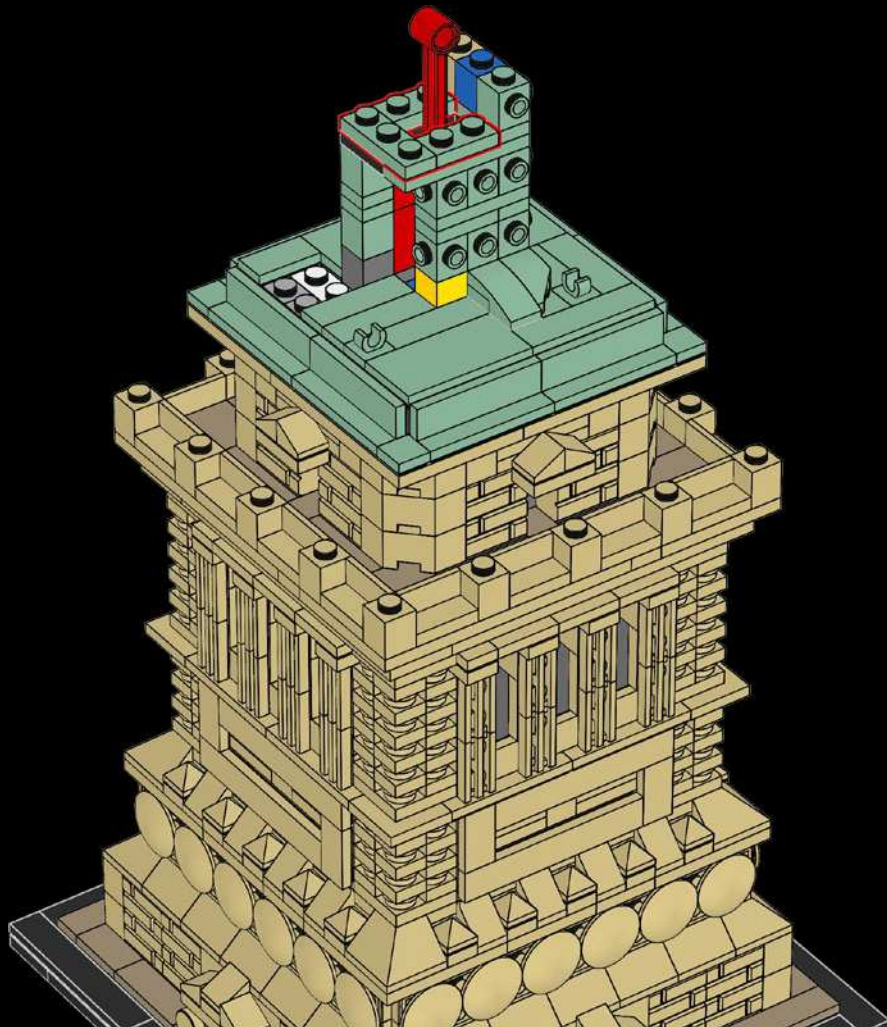

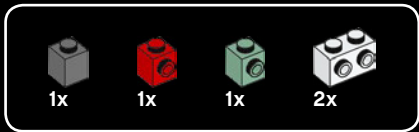

68



The Statue holds a tablet upon which is inscribed the date of the American Declaration of Independence (July 4, 1776).

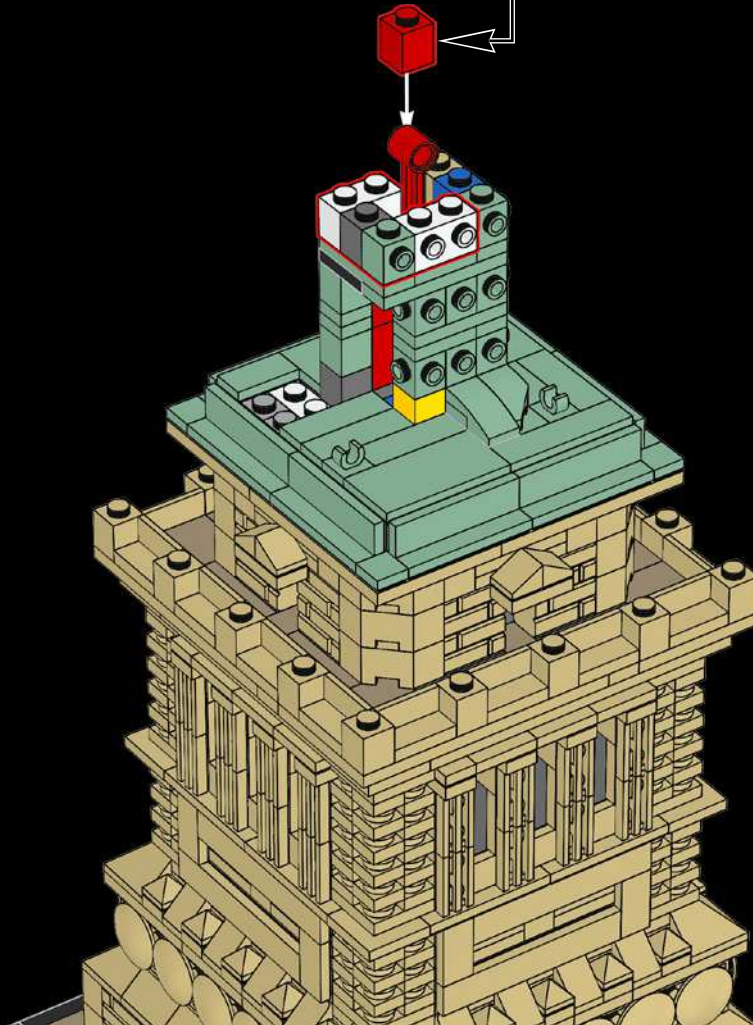

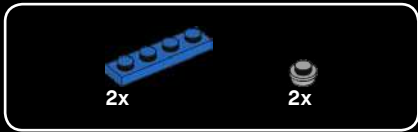

69

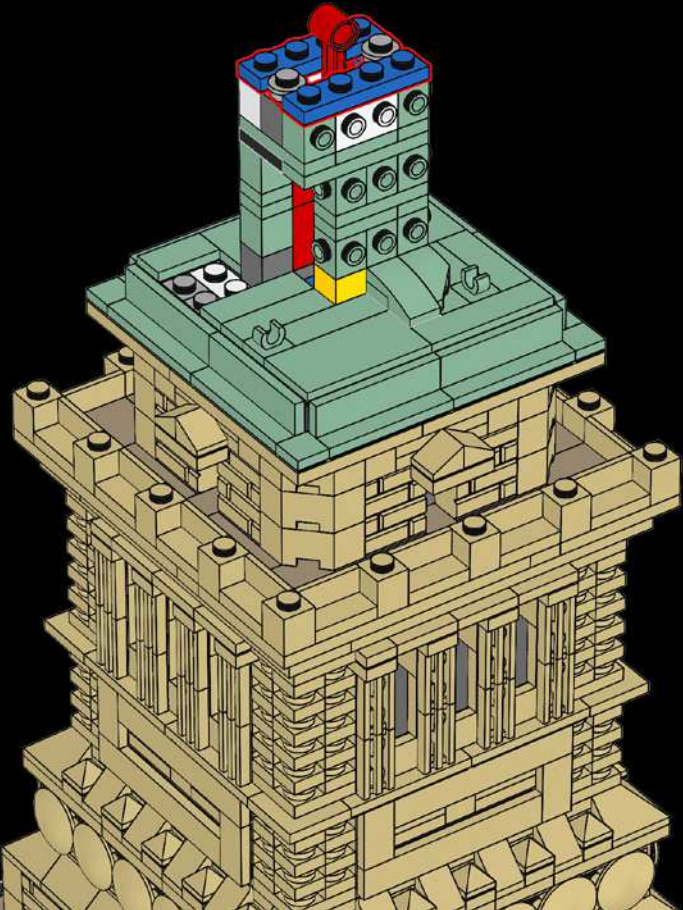



2x



1x

70

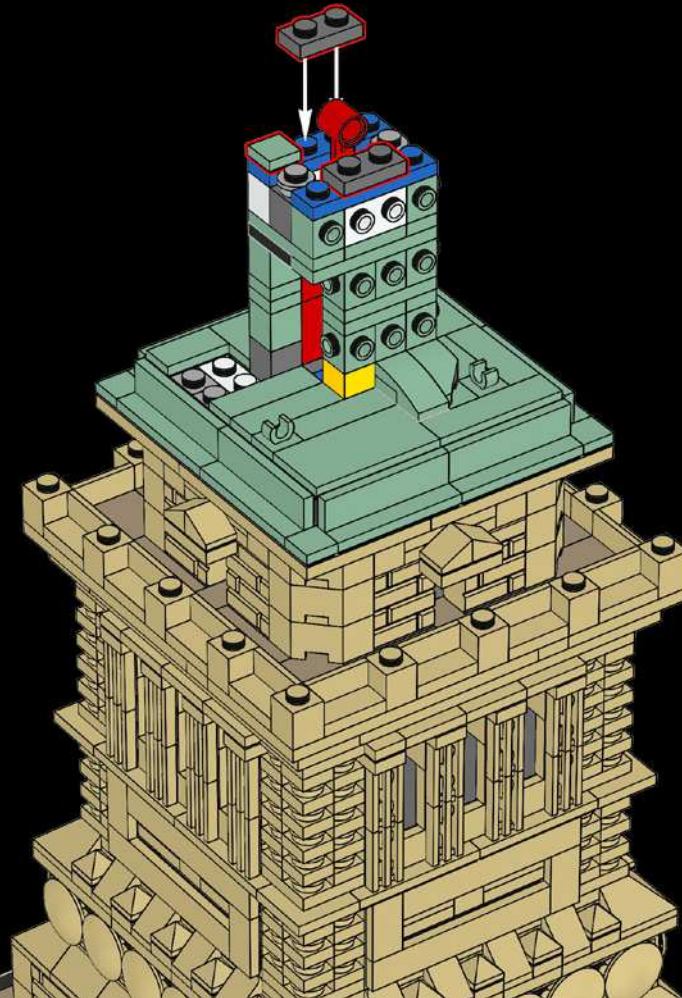

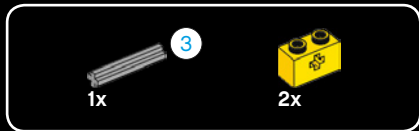

71

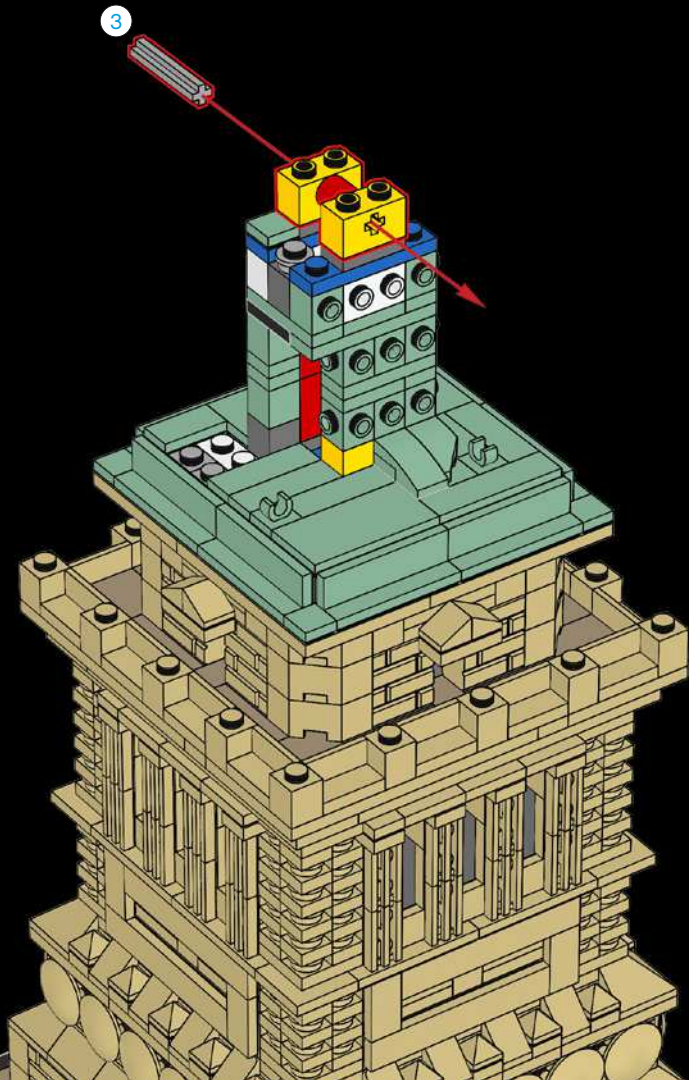

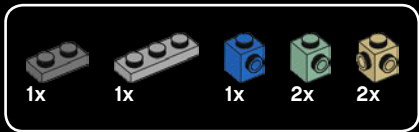

72

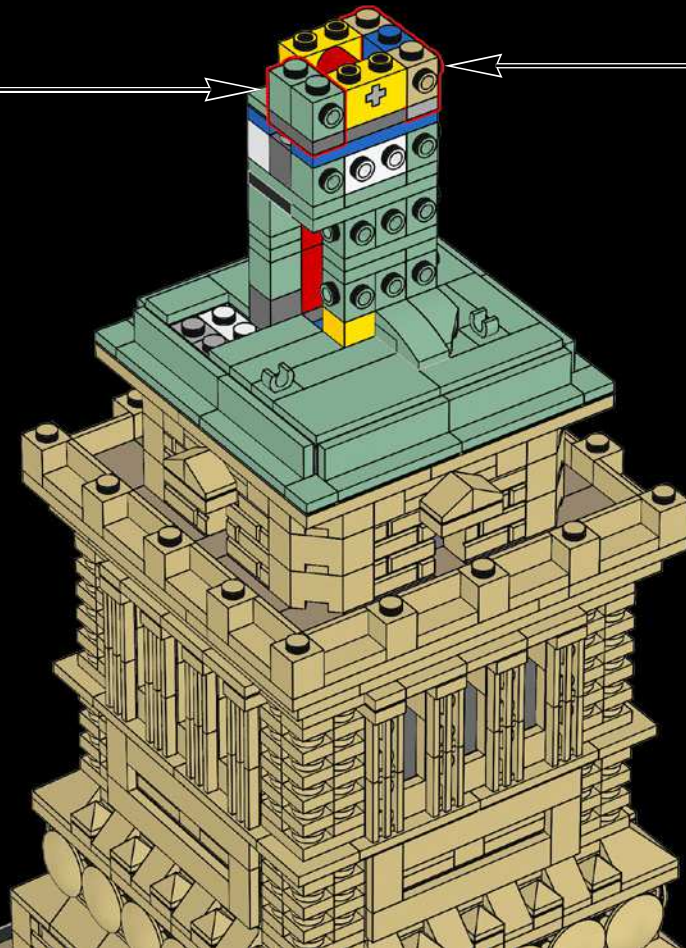



5x



5x



5x



5x



5x



5x



5x



20x



5x



5x

73

1



2



3

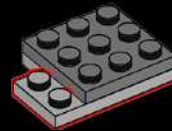

4

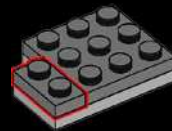

5

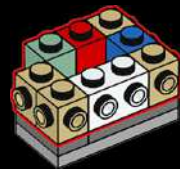

5x

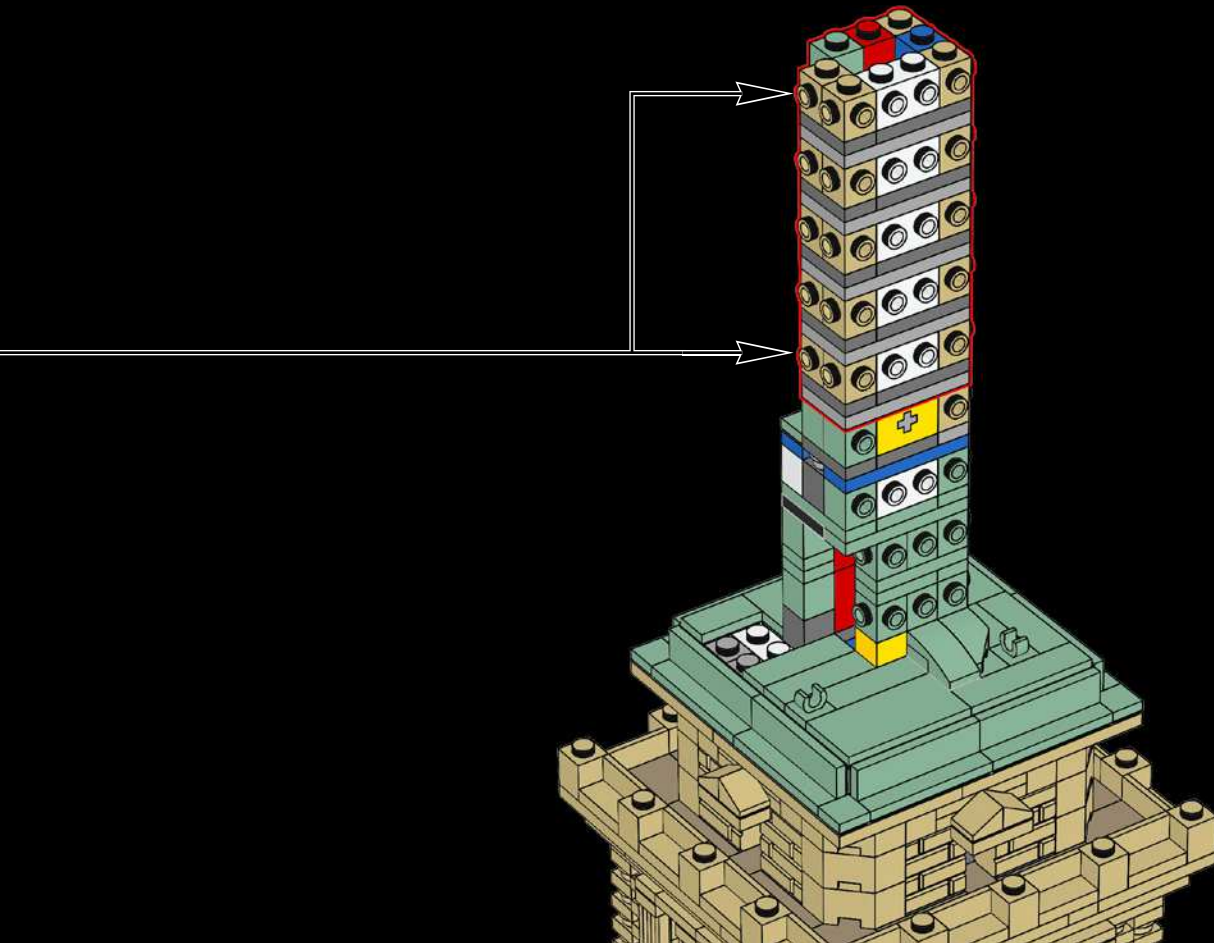



74

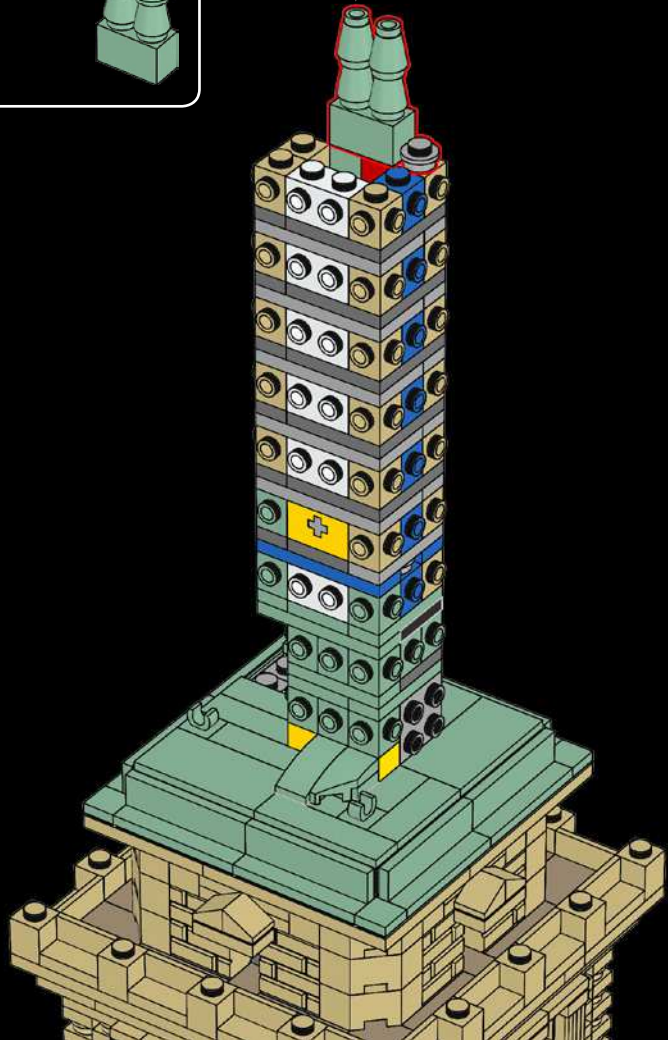
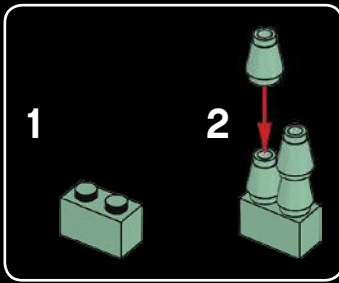

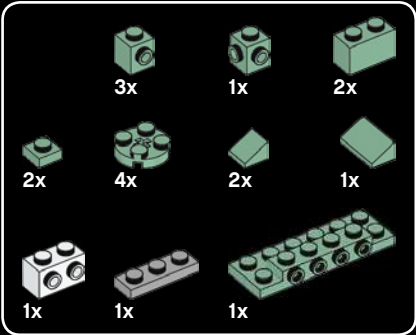
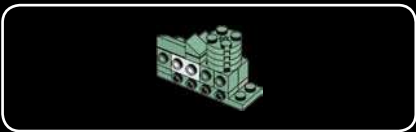

75

1

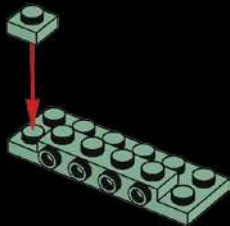

2

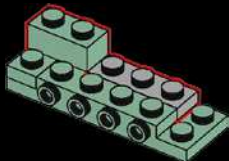

3

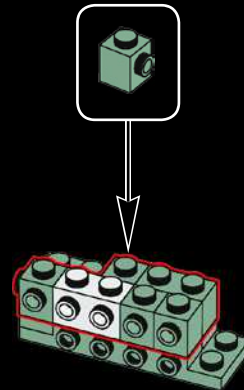

4

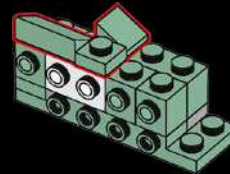

5

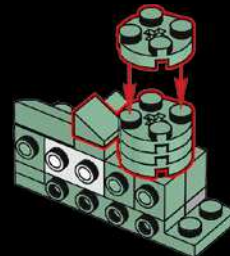

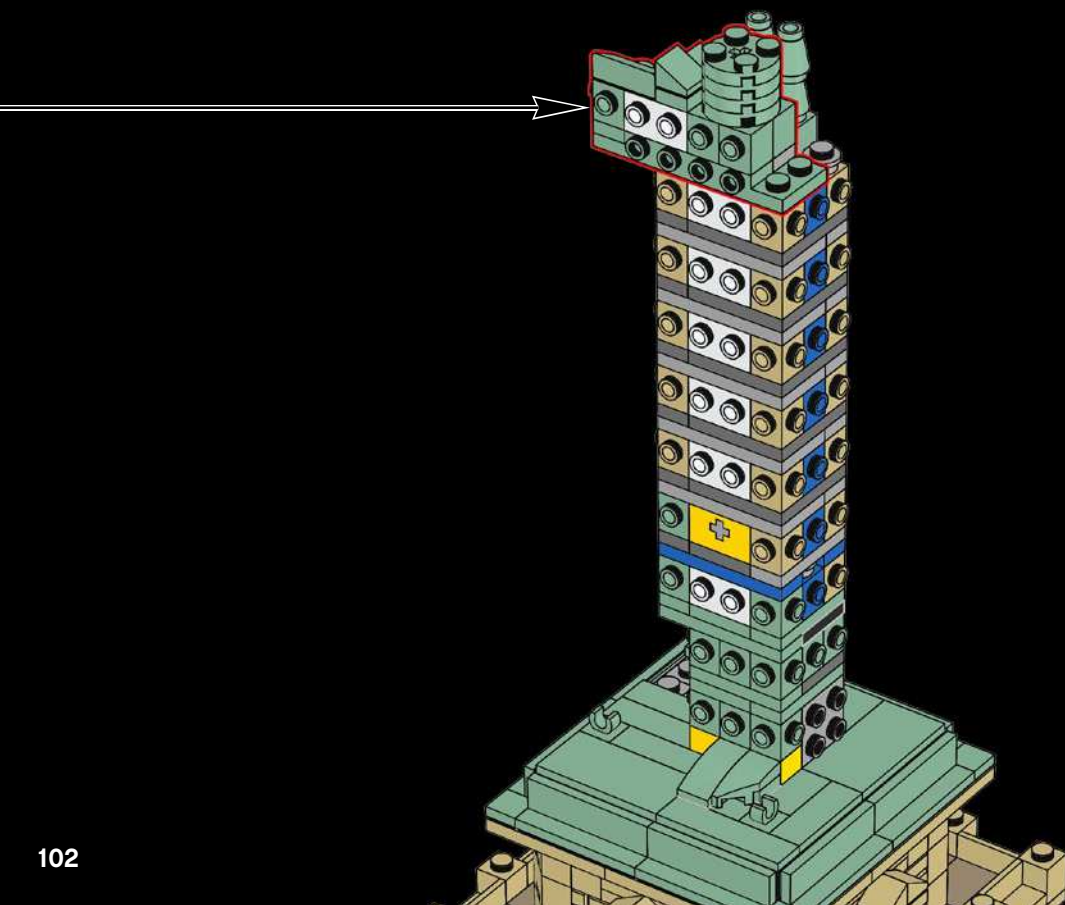

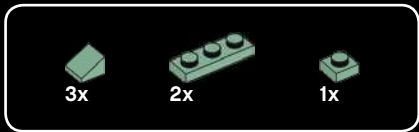

76

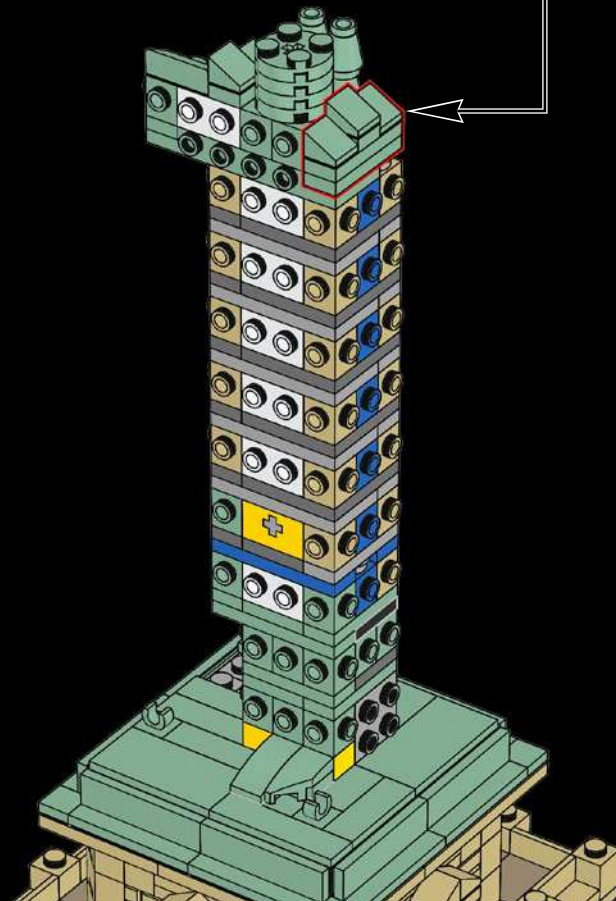
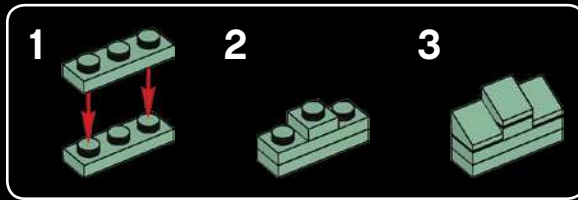

- 1x 
- 2x 
- 1x 

77

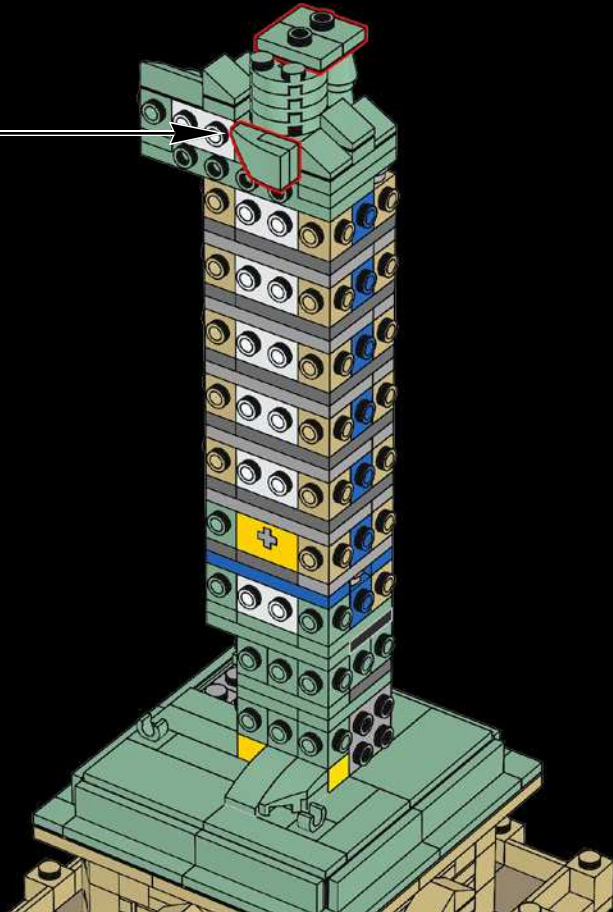



78

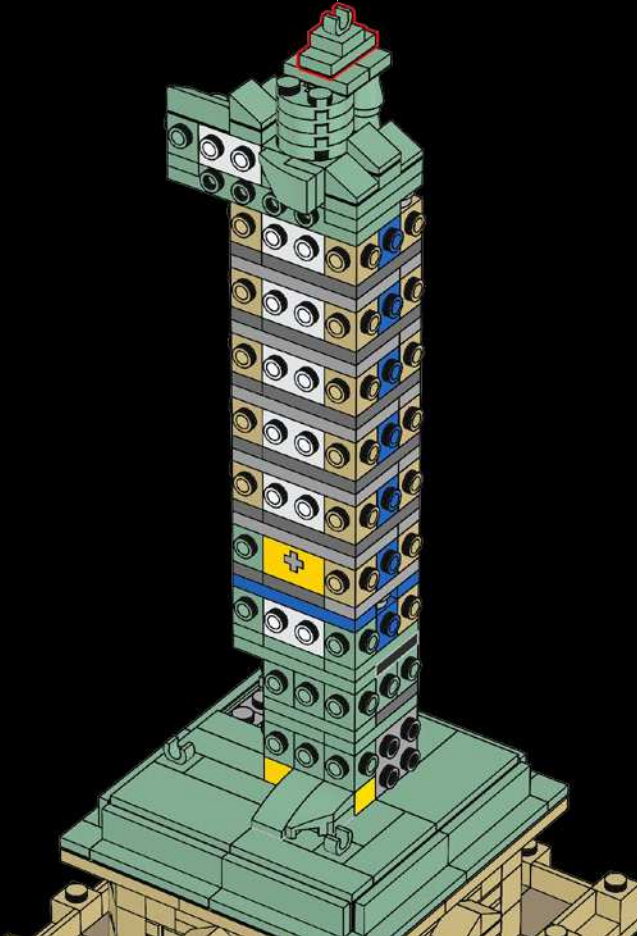
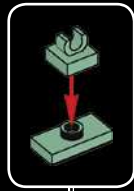



79

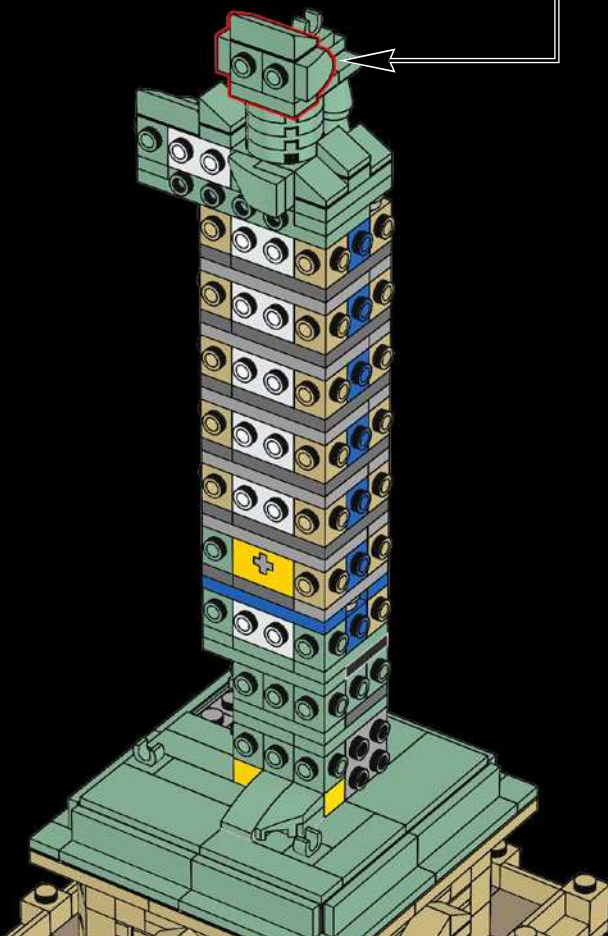
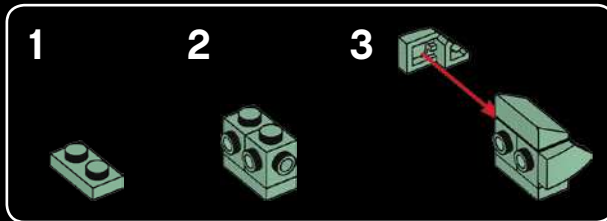

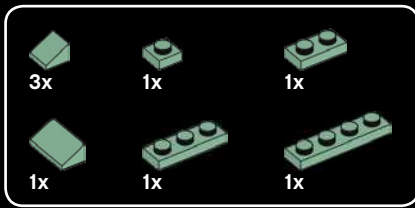

80

1



2



3

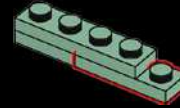

4

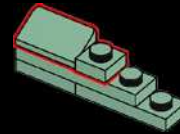

5

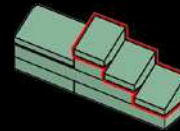

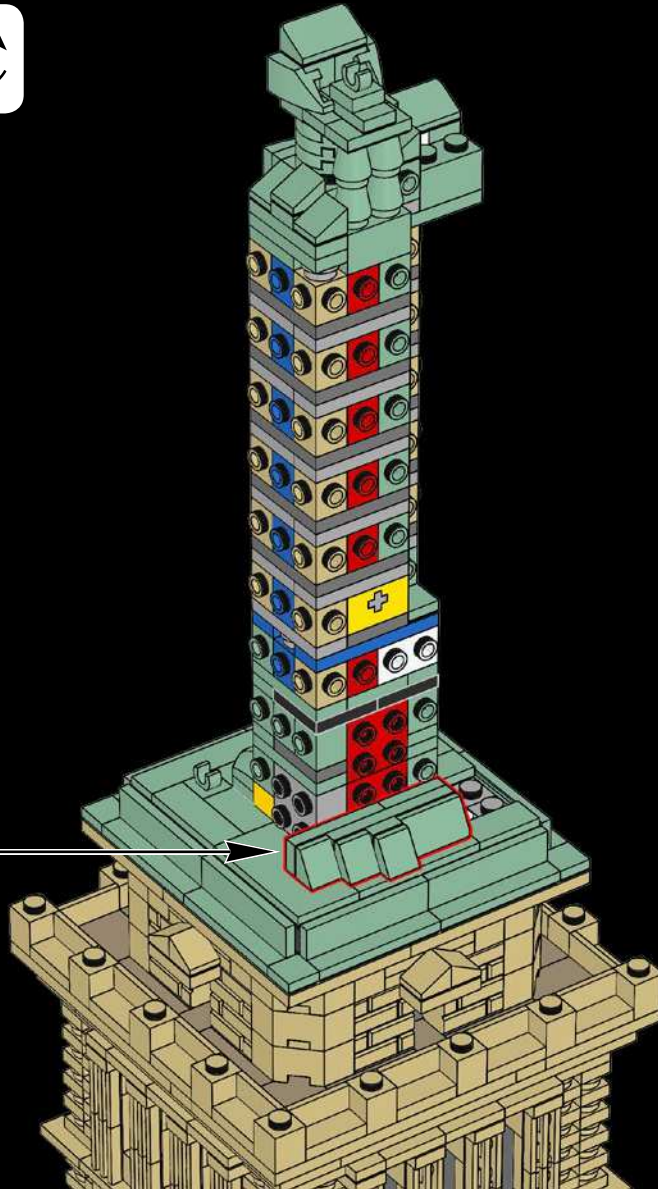



81

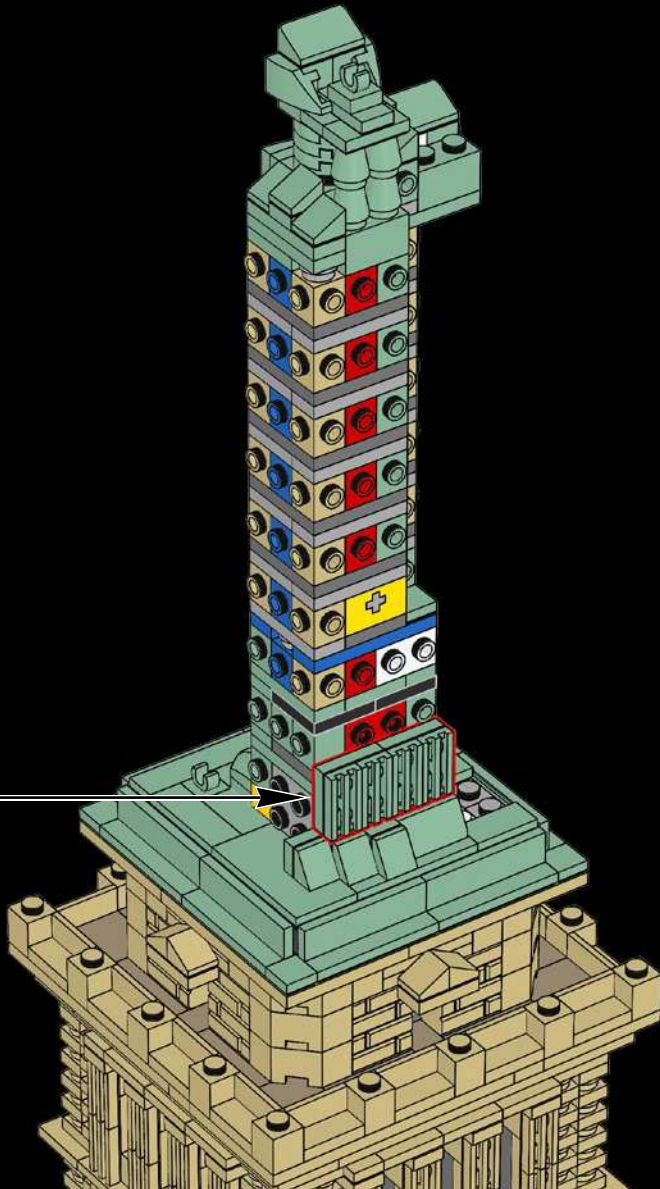
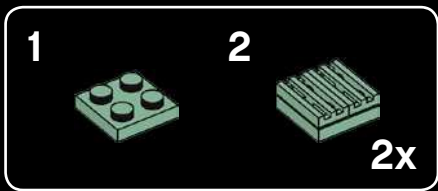

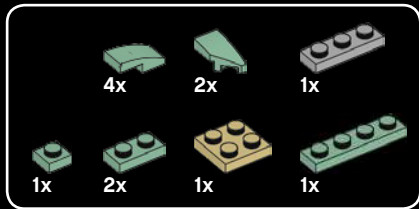

82

1



2



3

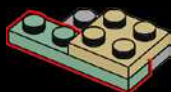

4

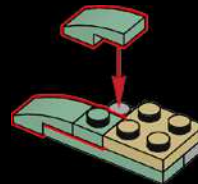

5

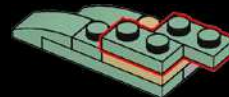

6

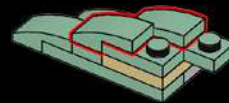

7

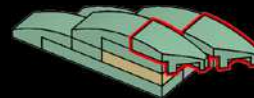

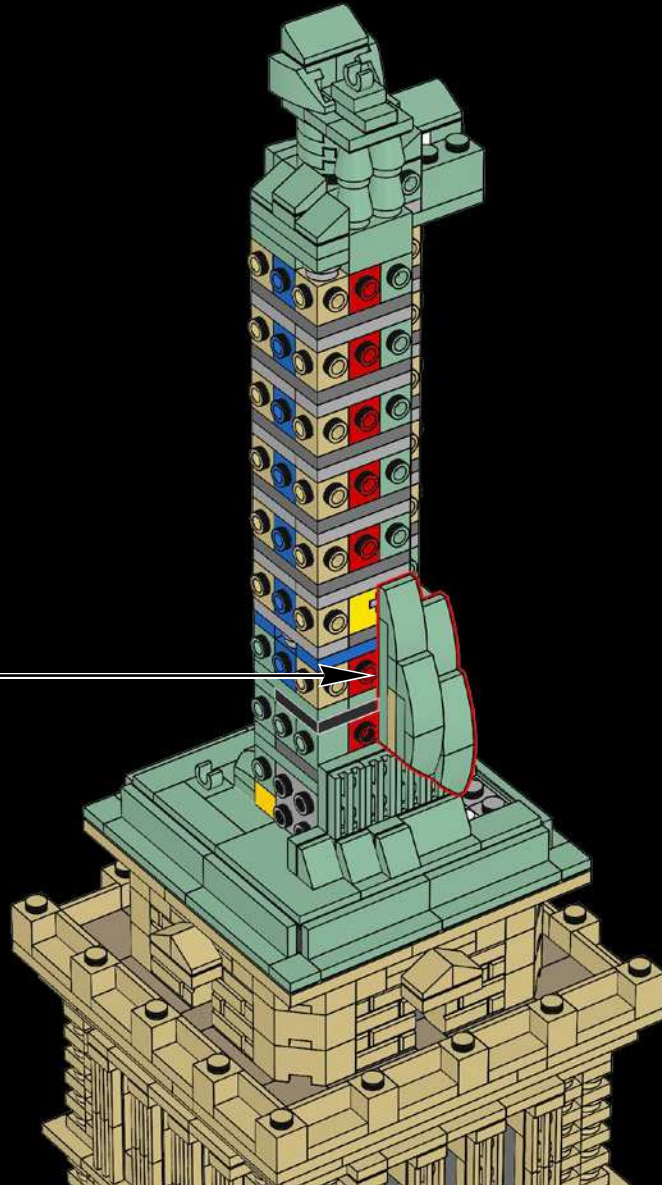

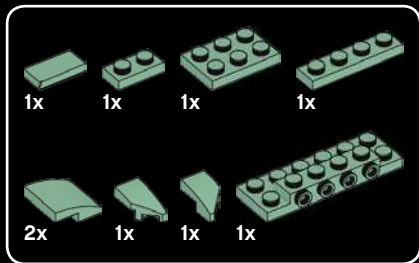

83

1

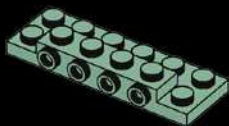

2



3

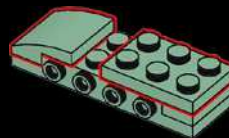

4

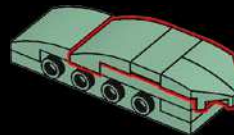

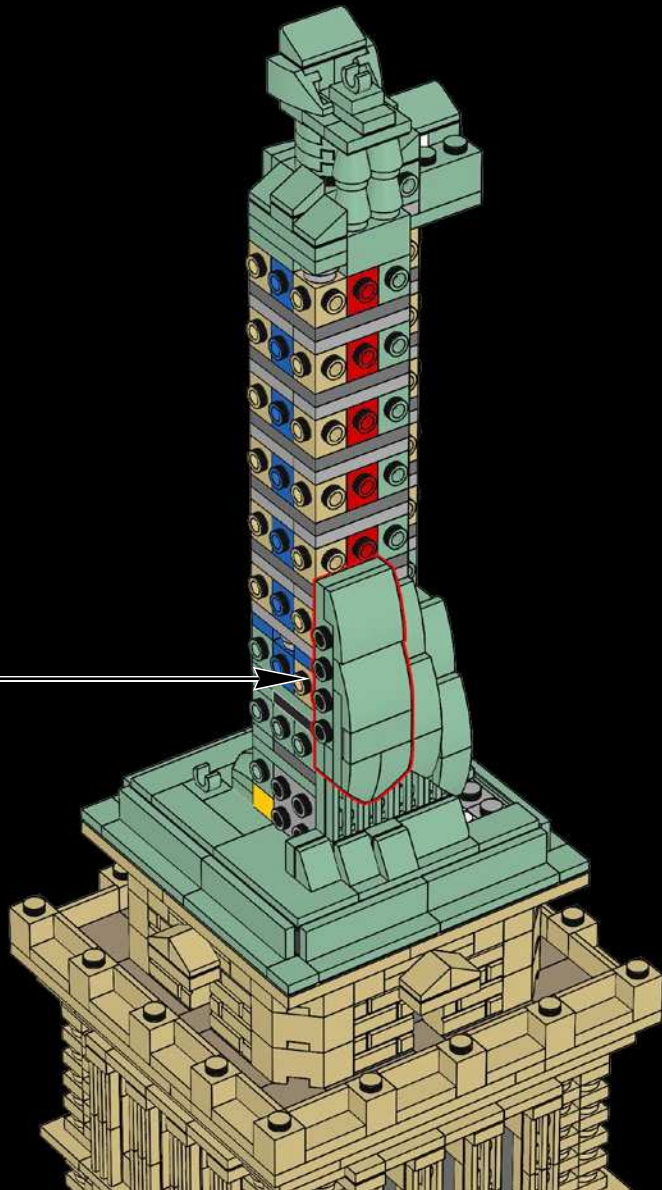

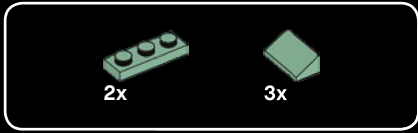

84

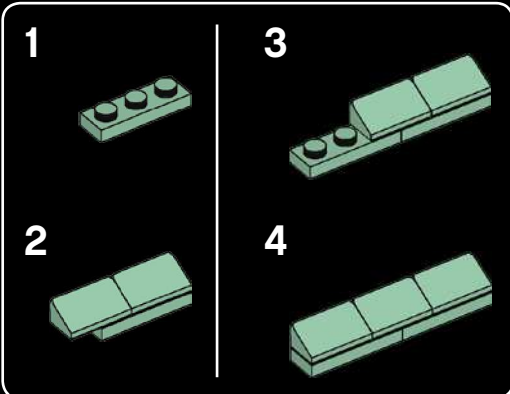
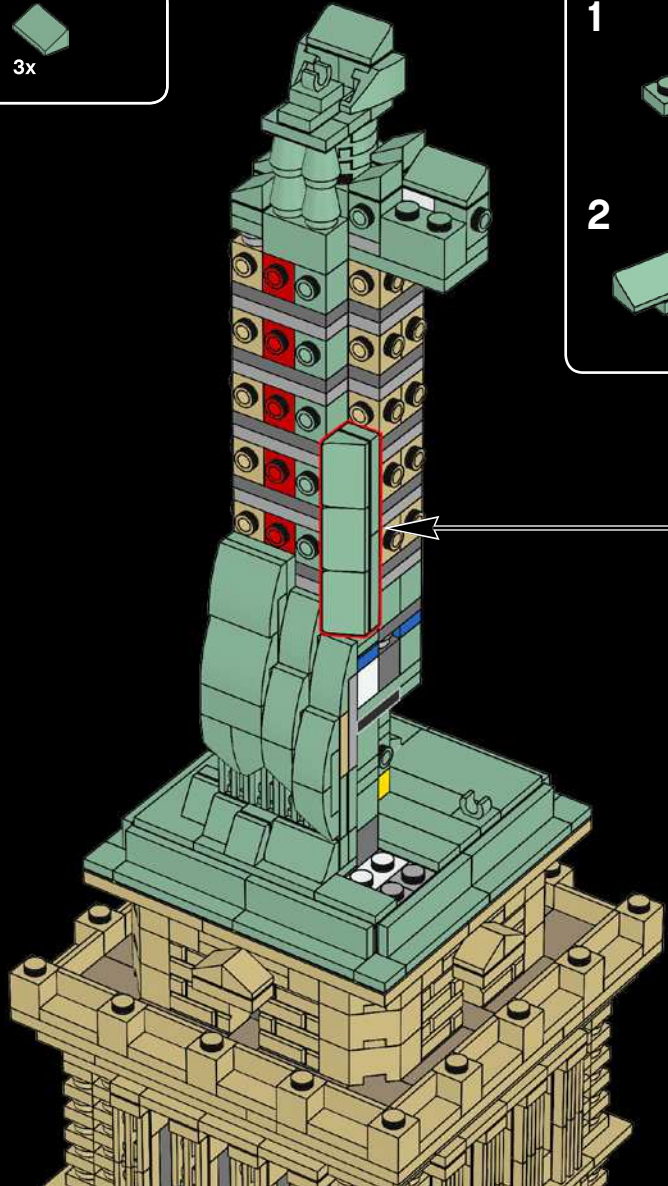

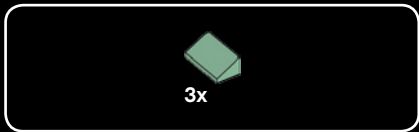

85

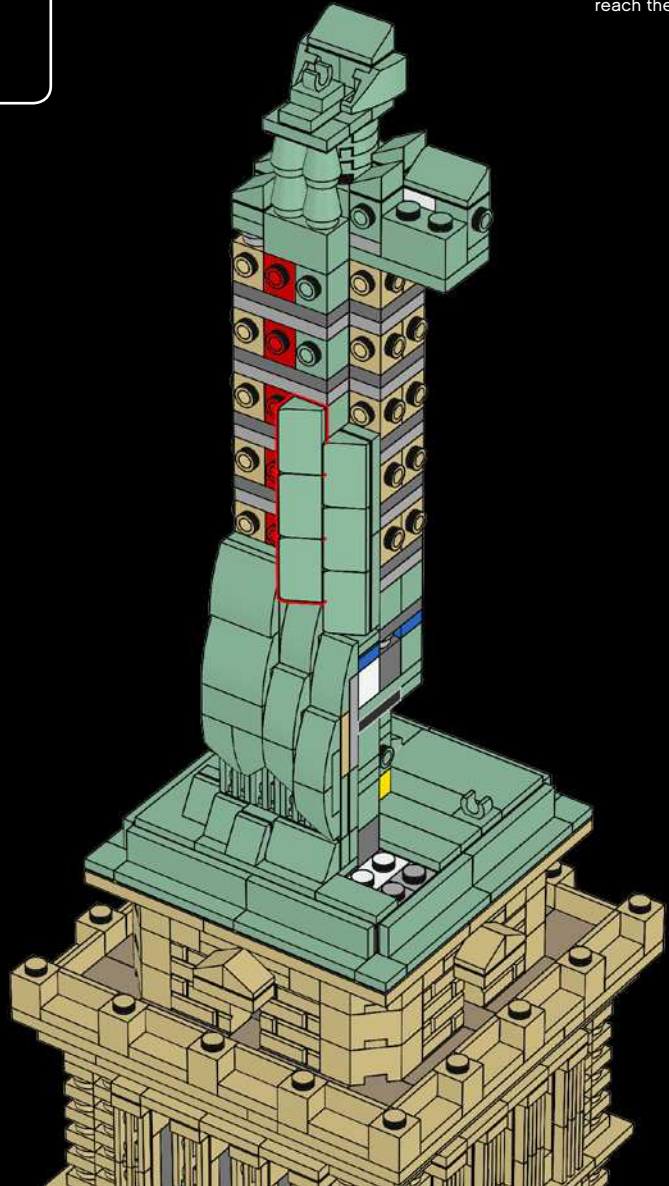

Visitors have to climb 354 stairs to reach the Statue's crown.



86

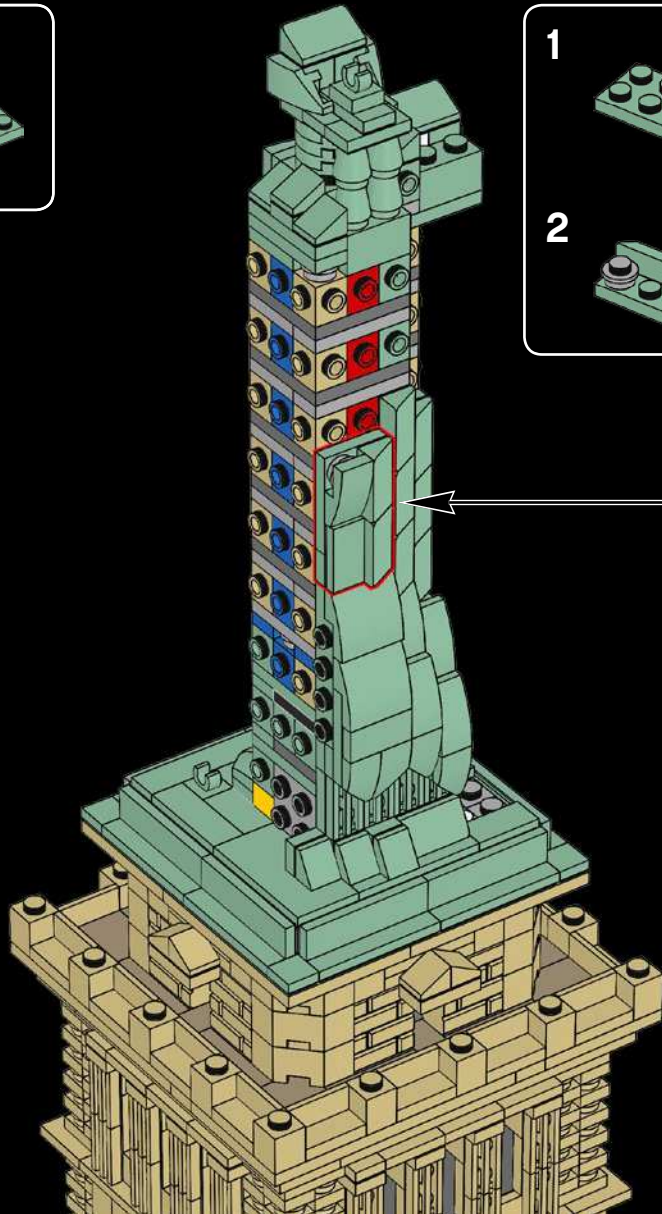
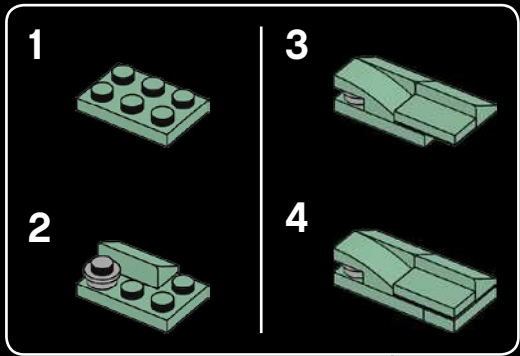
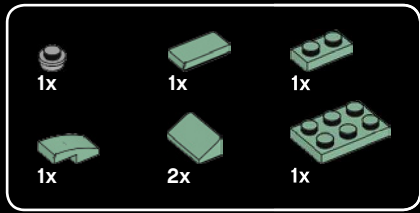

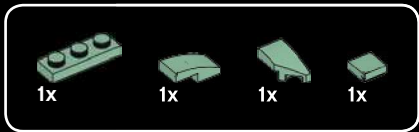

87

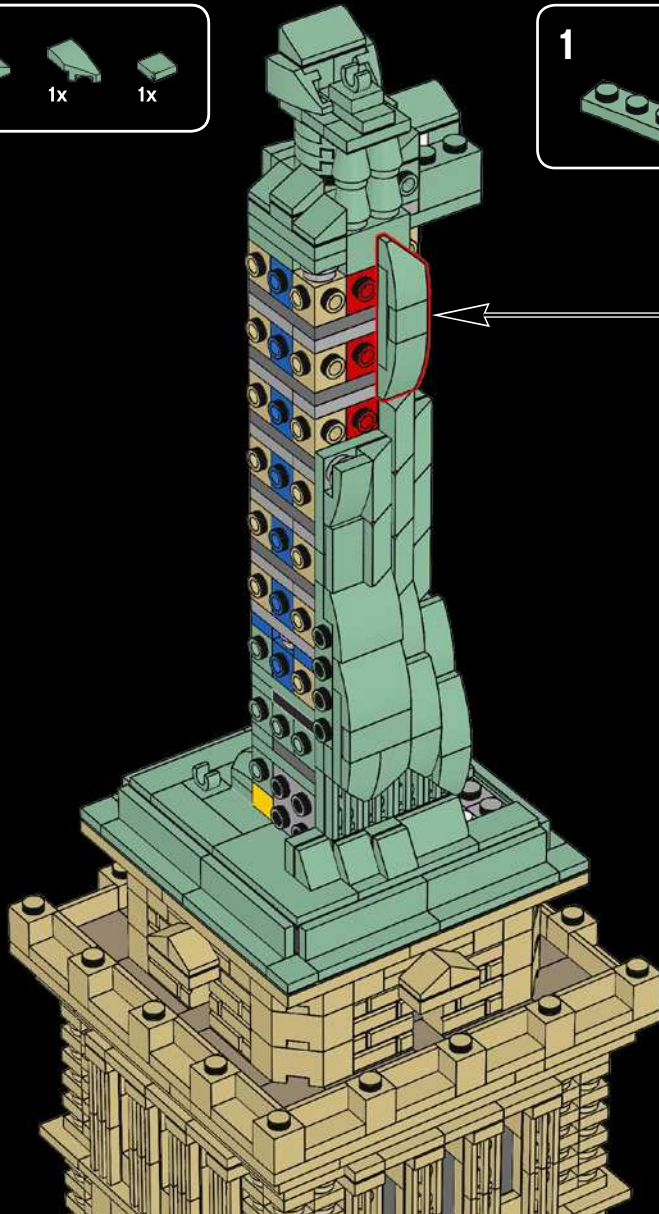
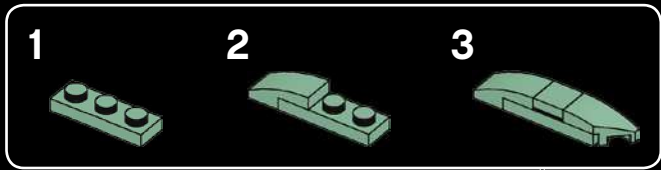

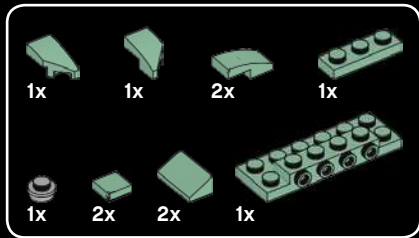

88

1



2

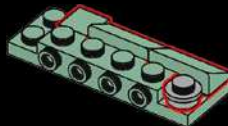

3

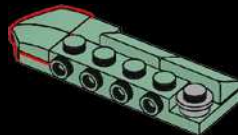

4

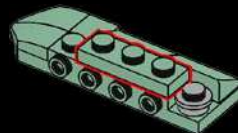

5

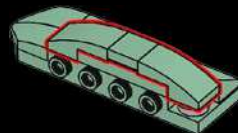

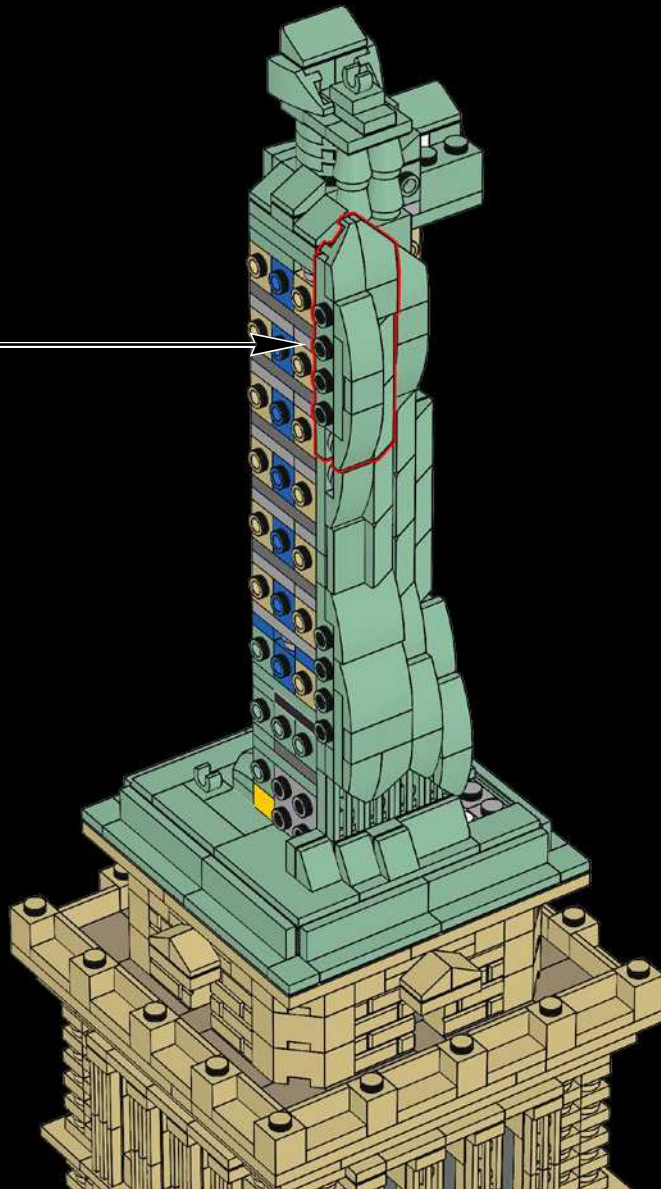

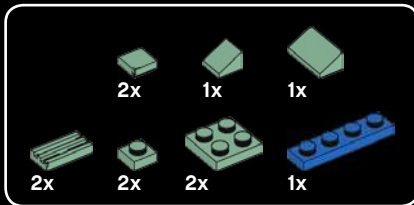
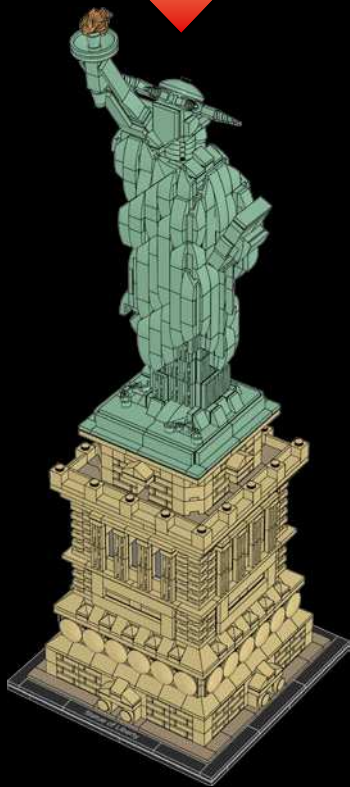

89

1



2



3

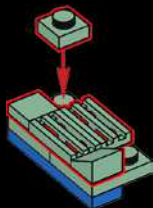

4

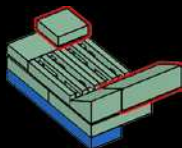

5

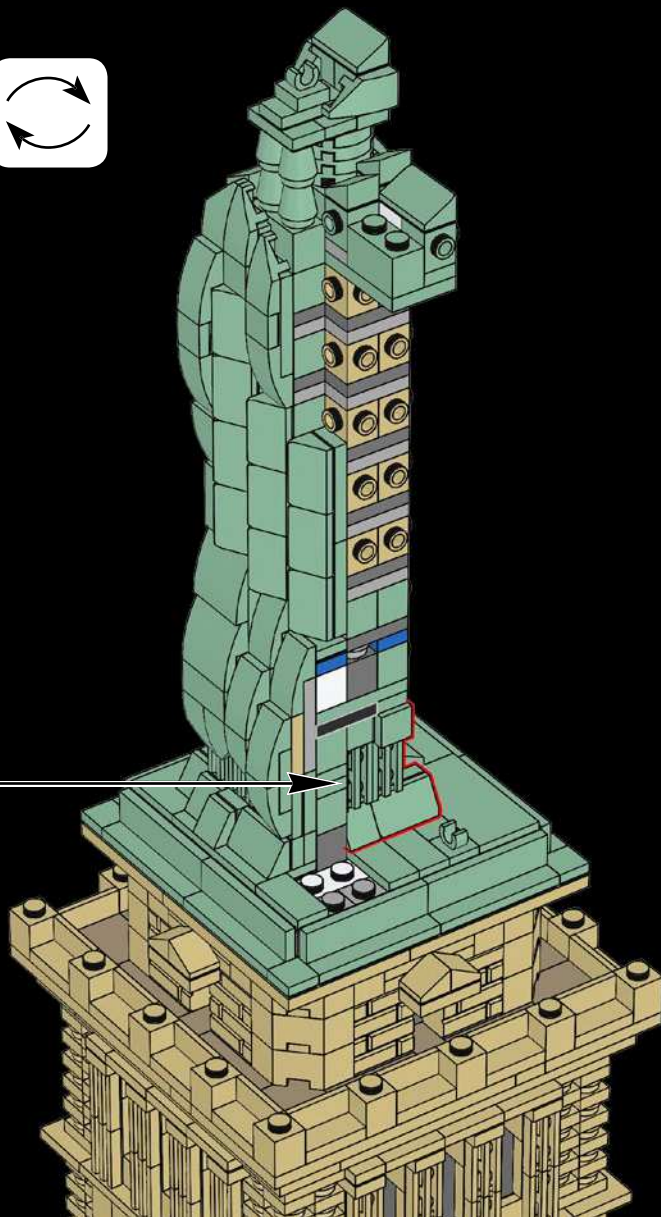
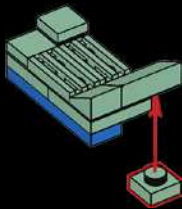

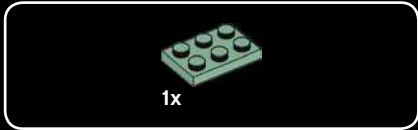
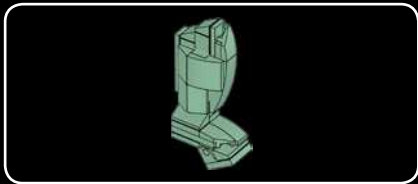

1x

90



1x

1x

1x

91



1x

1x

1x

92

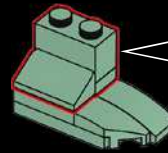
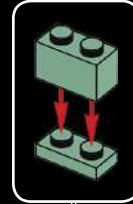

2x

93

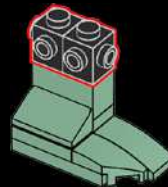



94

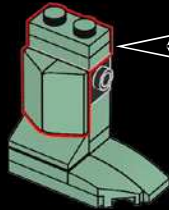
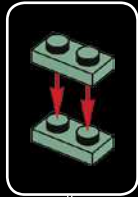

95

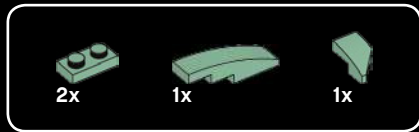
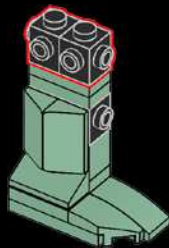

96

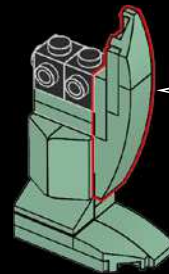
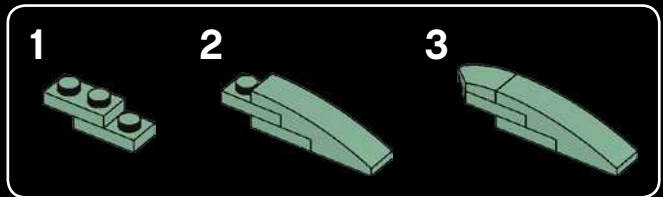



97

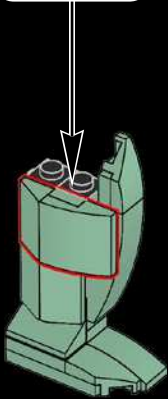
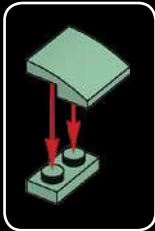

98

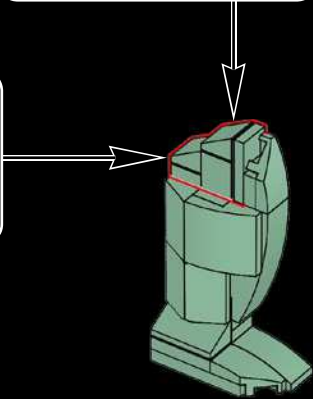
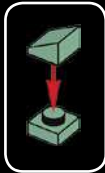
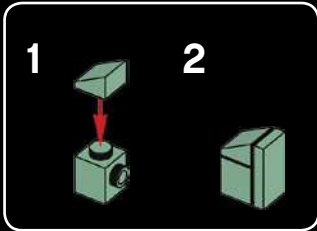

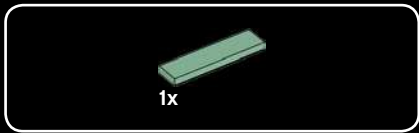

99

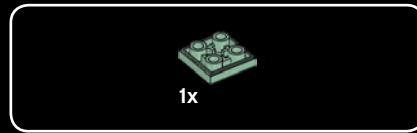
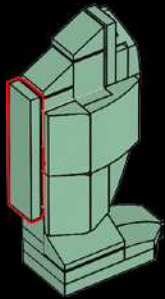

100

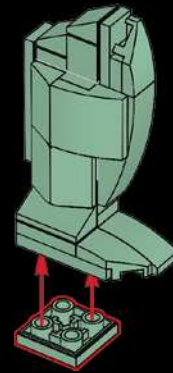



101

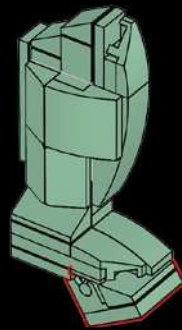
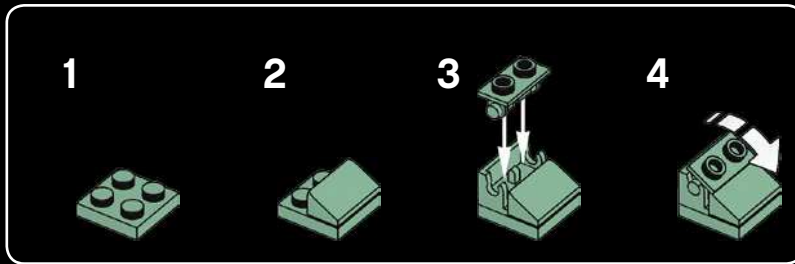



102

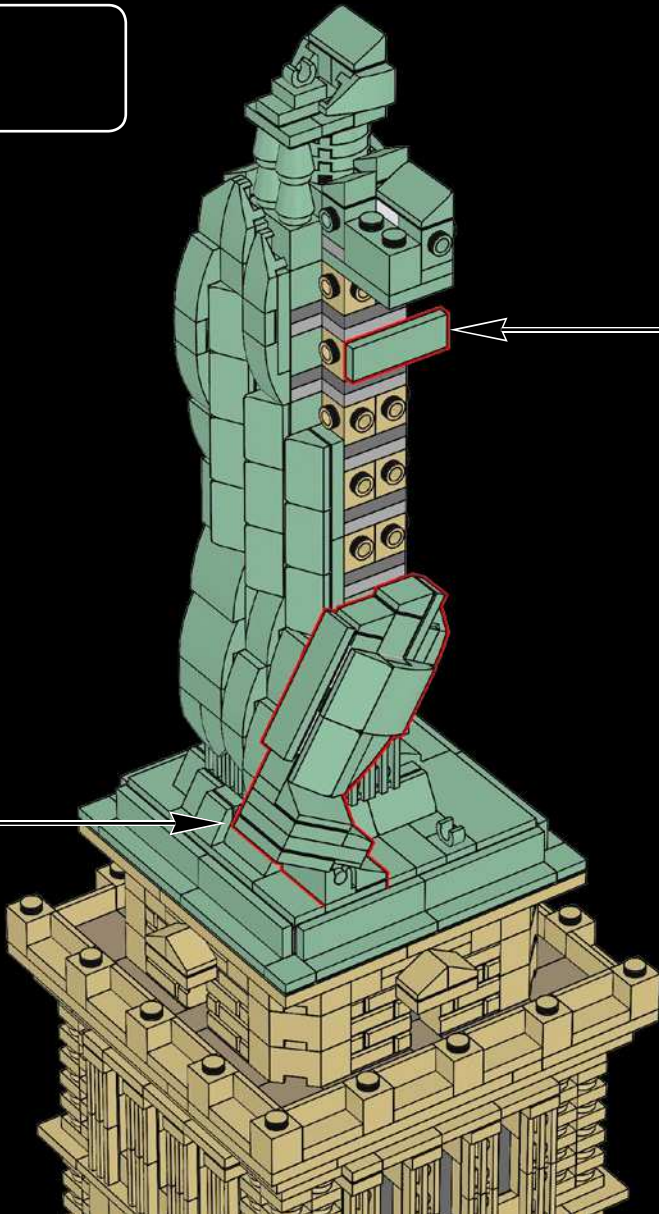

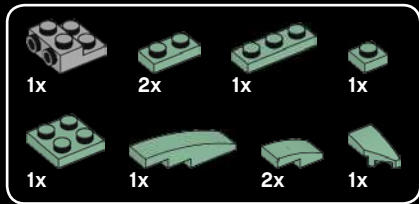

103

1

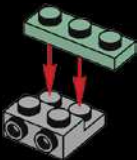

2



3



4

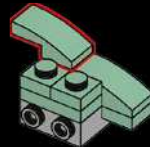

5

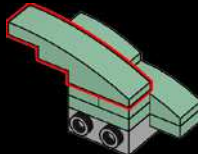

6

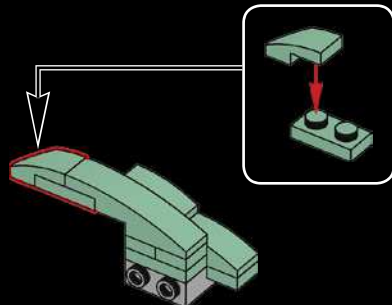

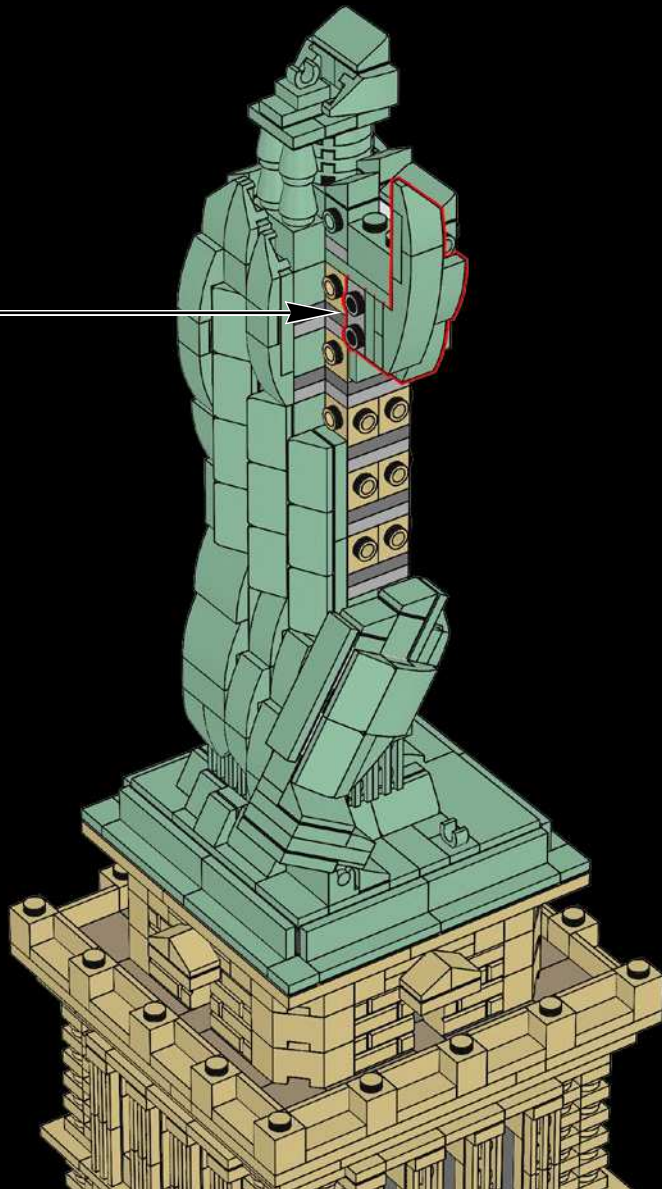

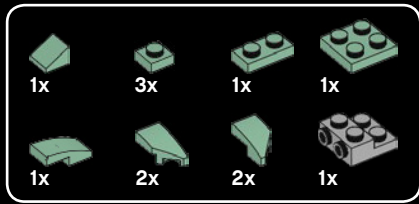

104

1



2

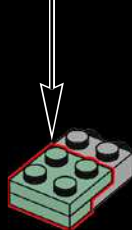
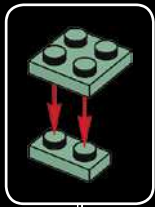

3



4



1



2



5

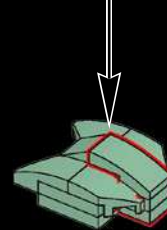

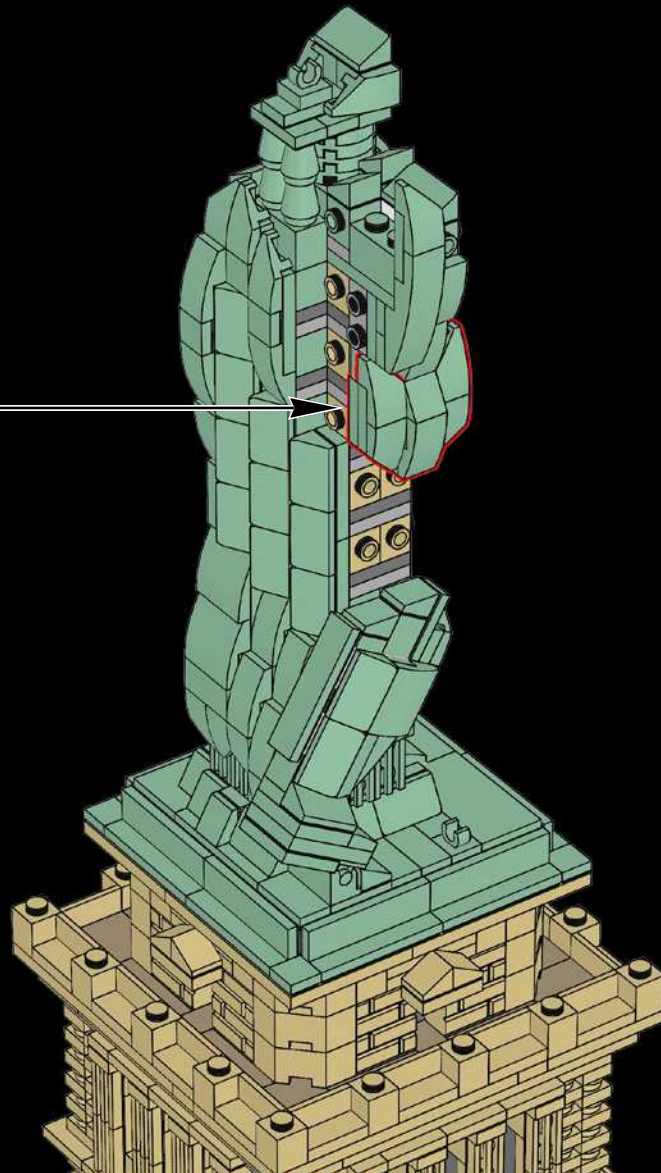

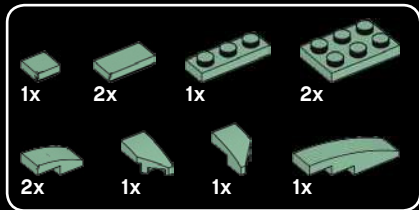

105

1

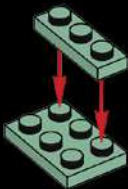

2



3



4

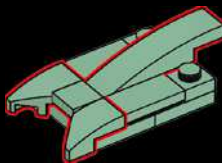

5

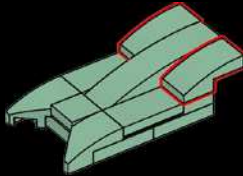

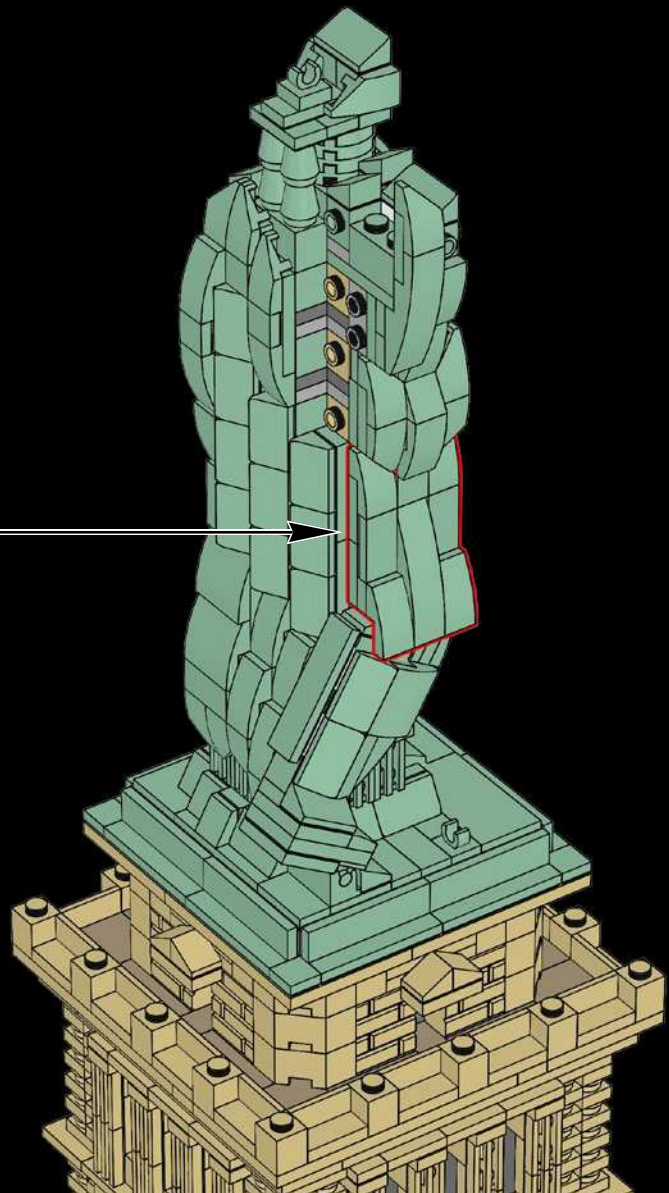

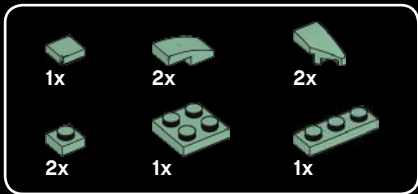

106

1

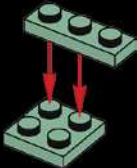

2



3

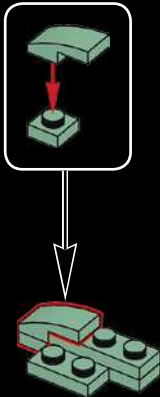

4



When the Statue was first erected in 1886 it was the tallest iron structure in the world.

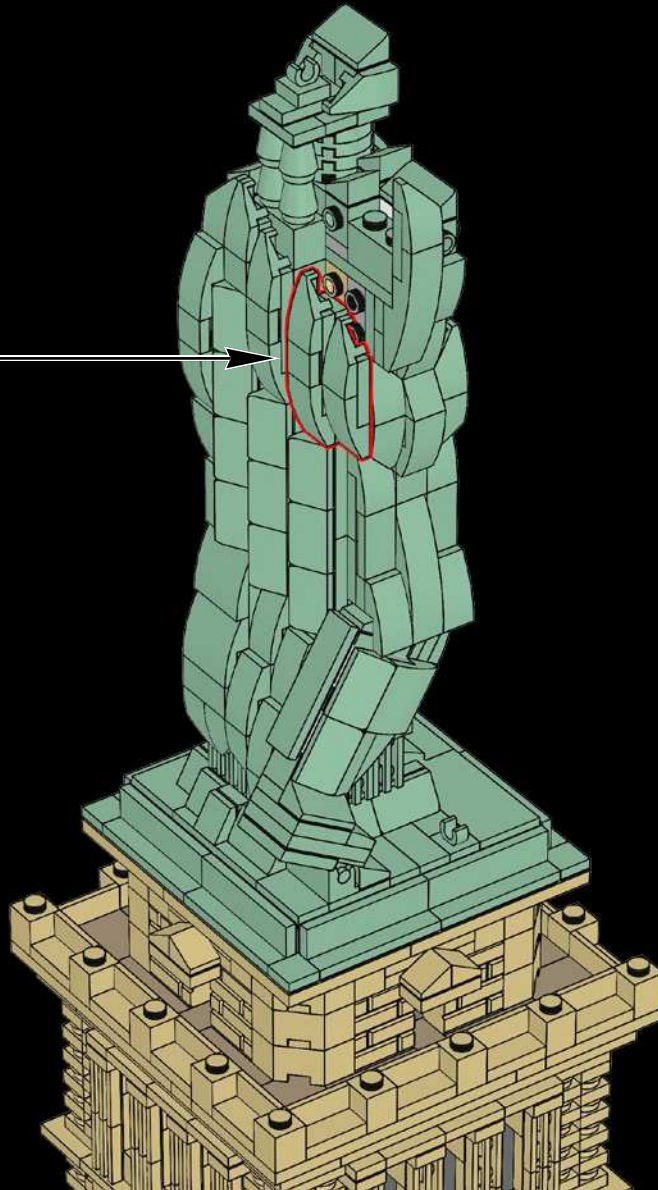

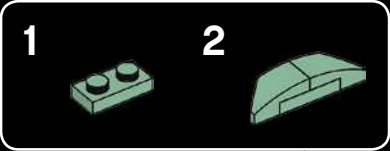

107

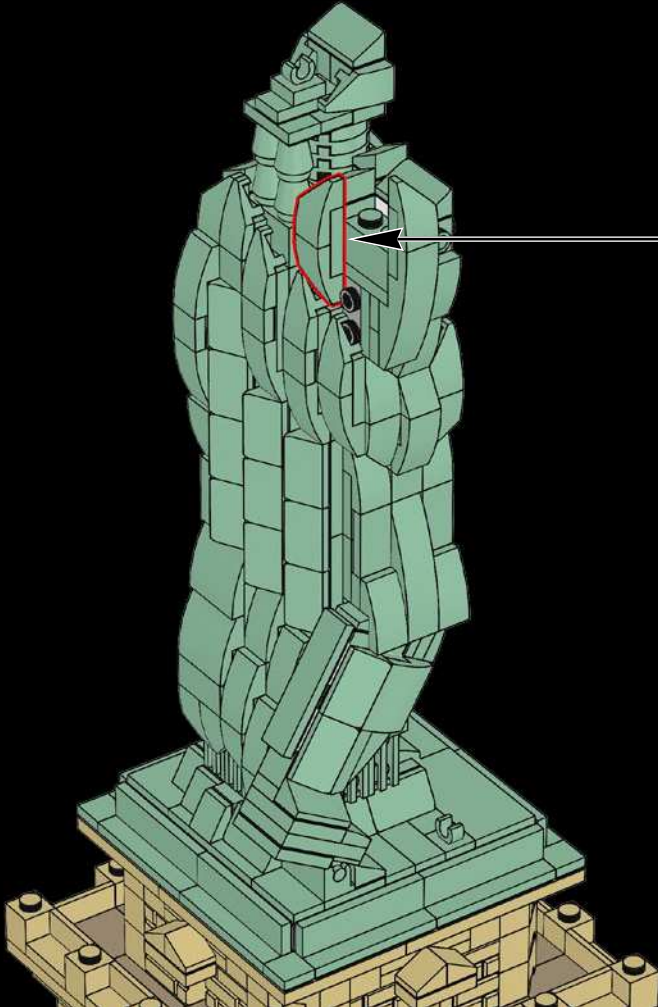

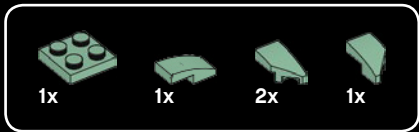

108

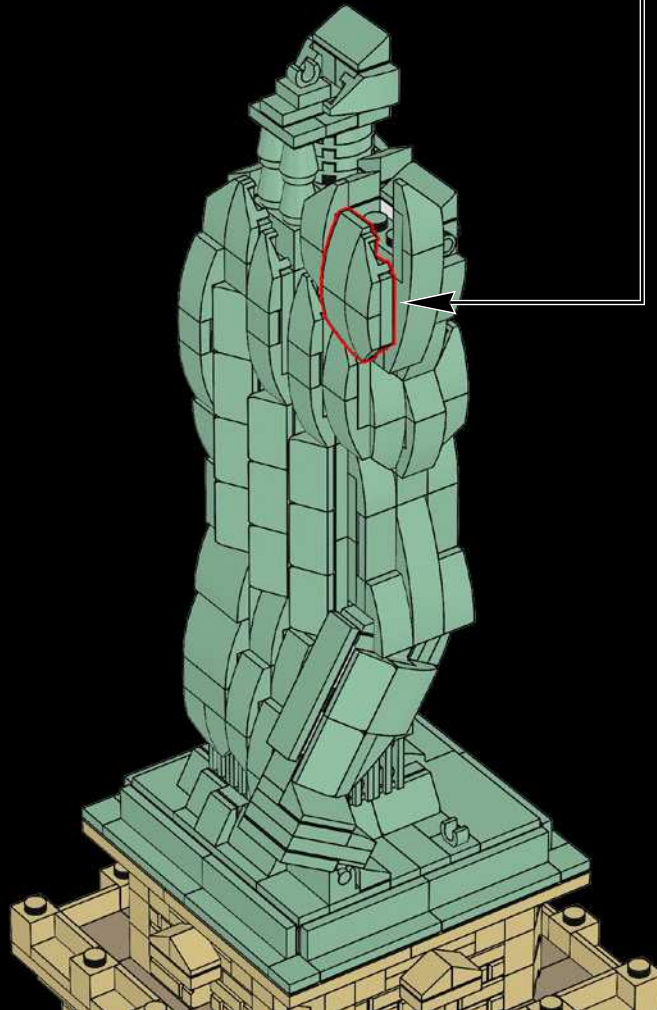

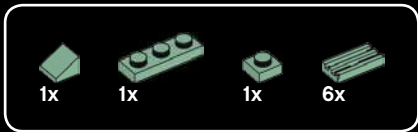

109

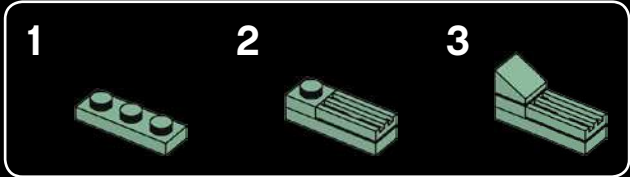
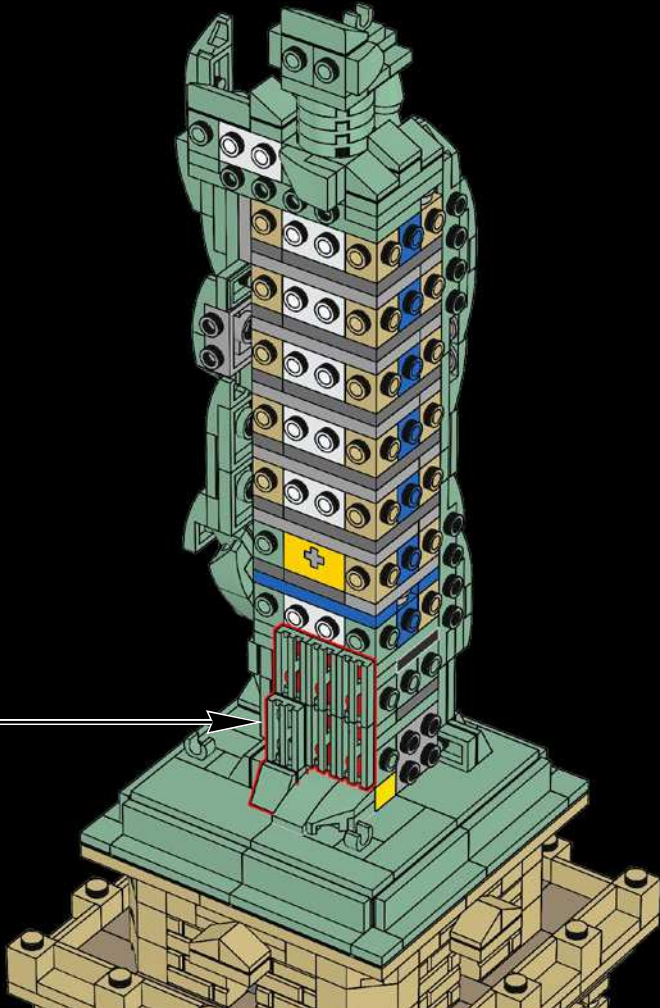

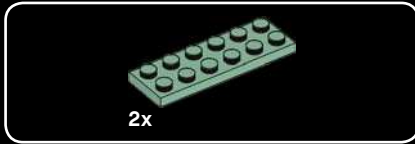
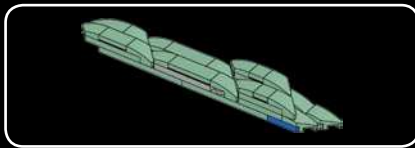

110

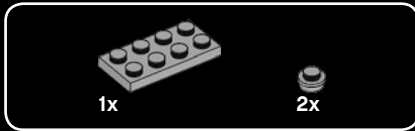
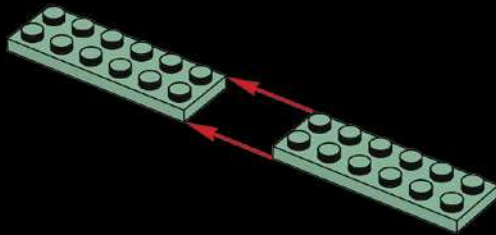

111

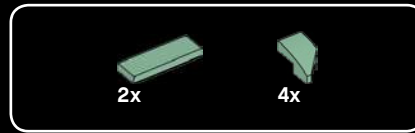
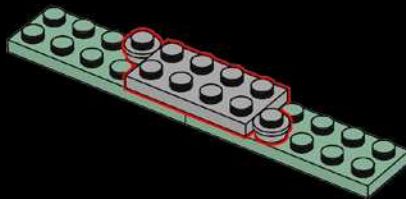

112

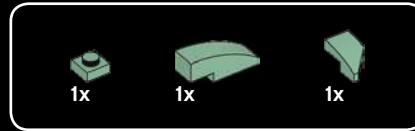
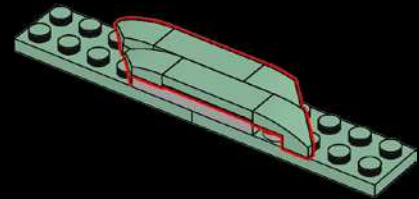

113

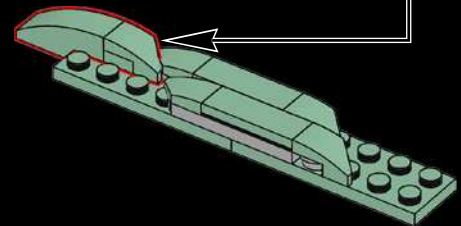
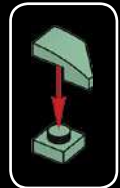

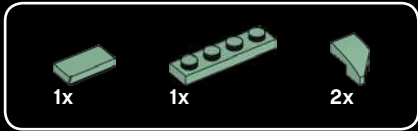

114

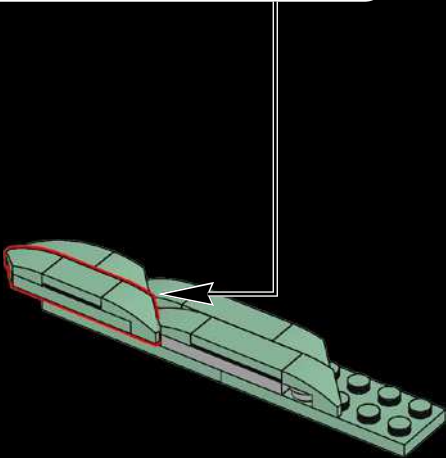
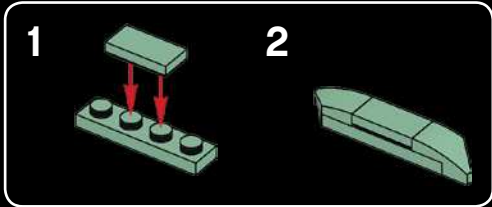

115

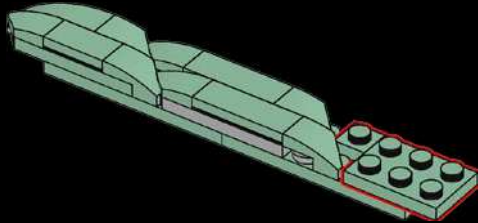

116

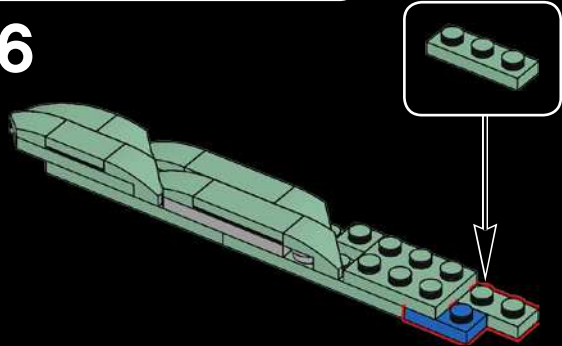

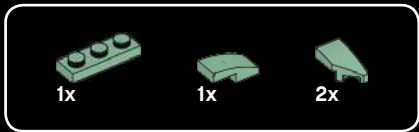

117

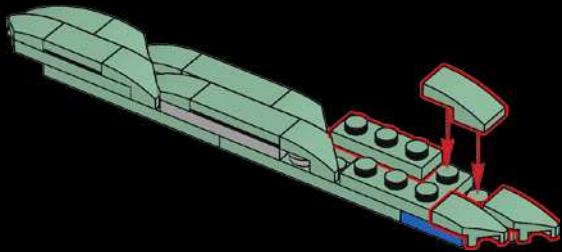

118

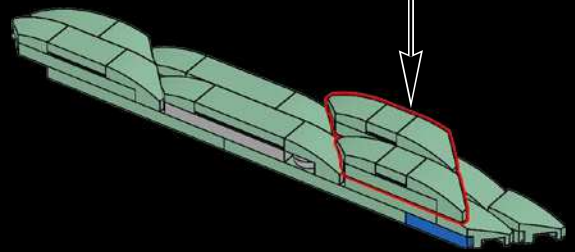
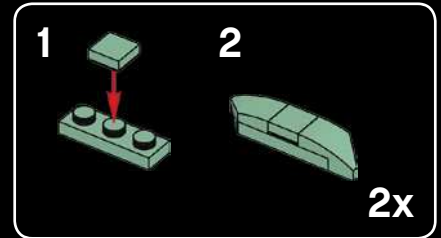

119

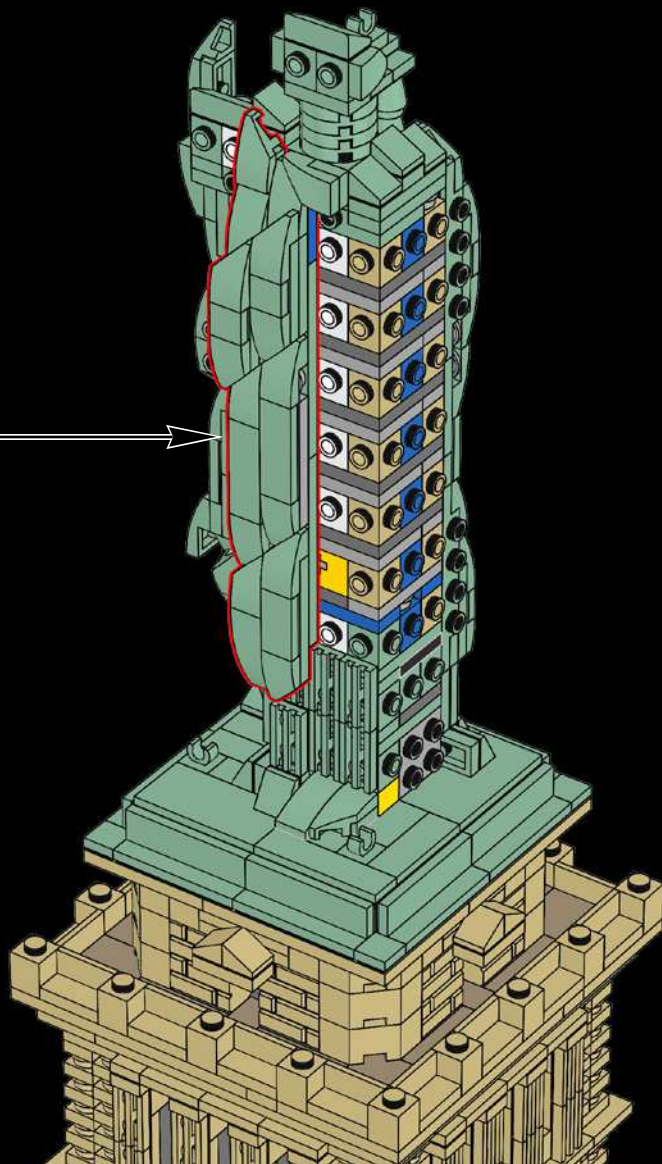

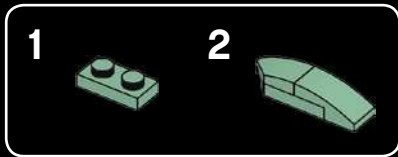

120

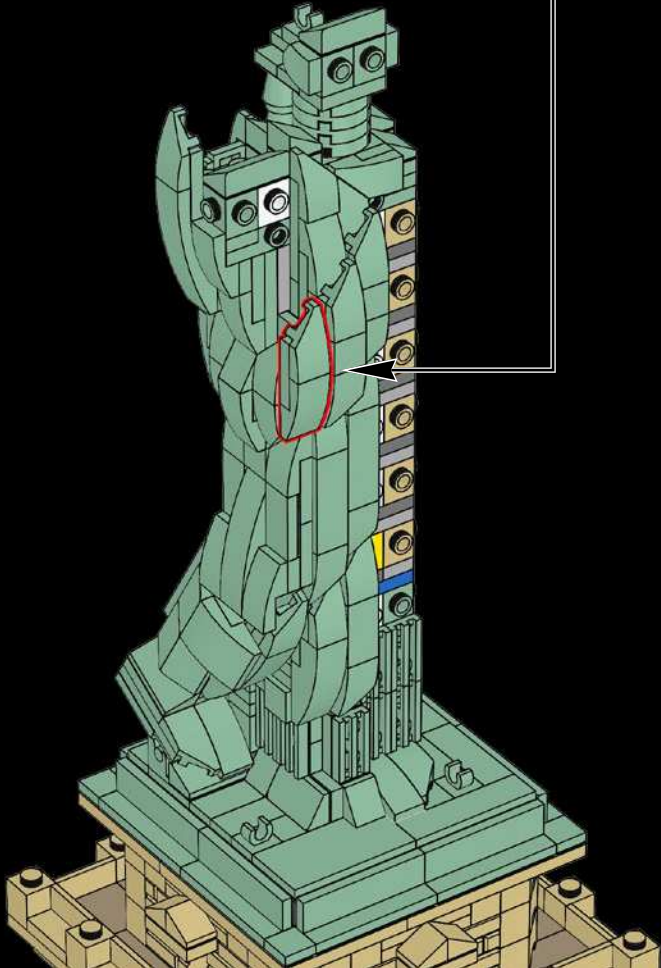

121

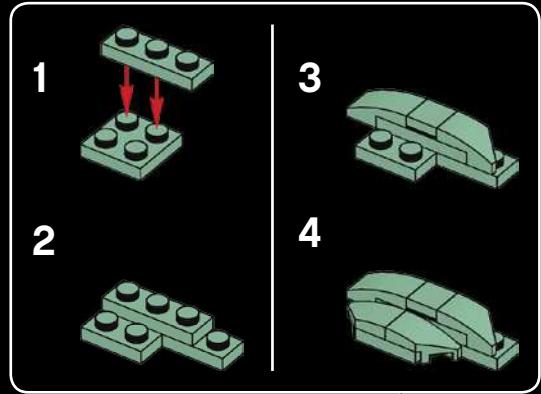
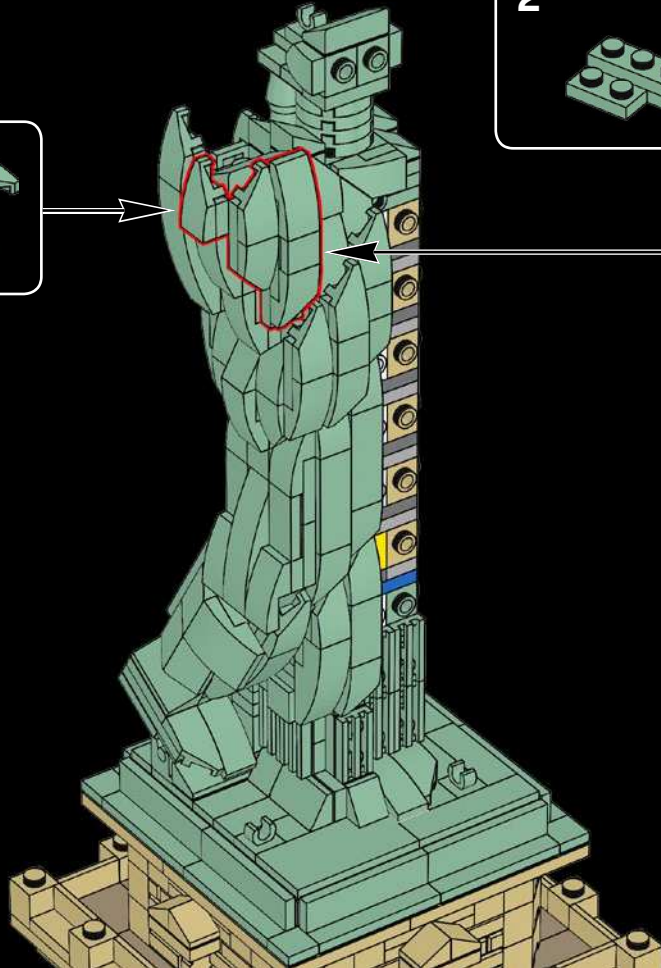
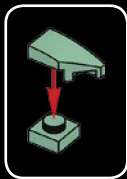
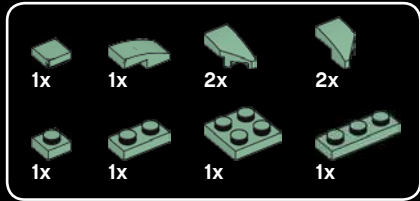

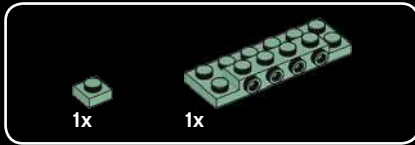
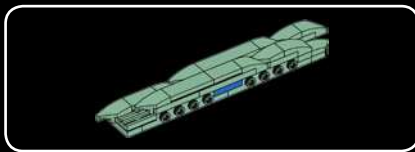

122

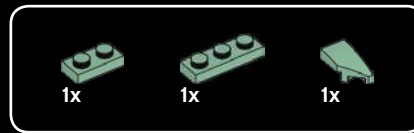
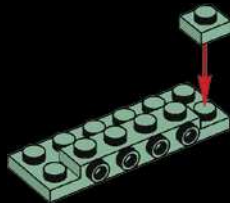

123

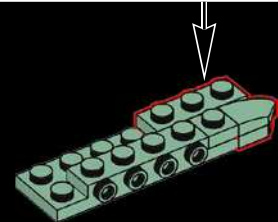
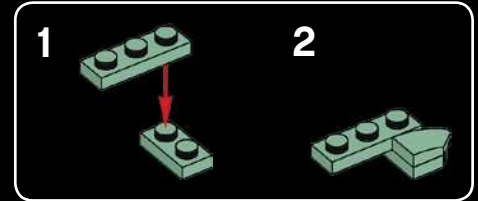

124

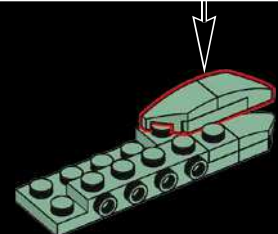
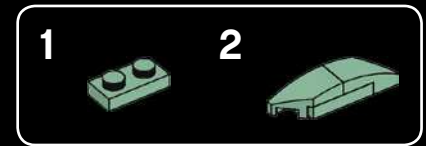

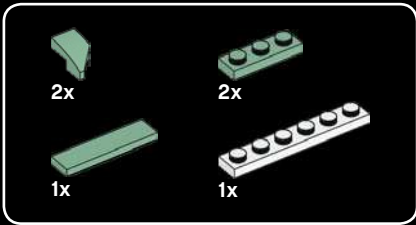

125

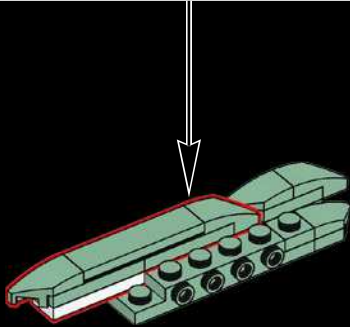
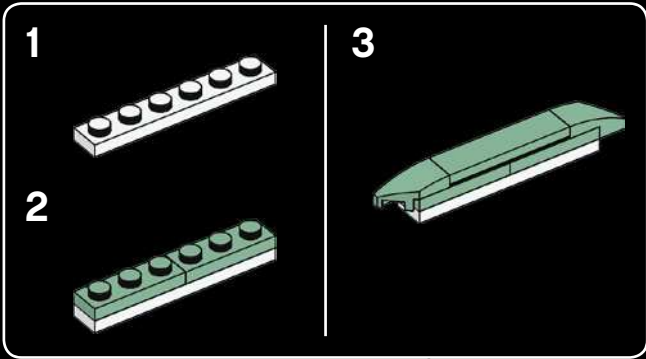

126

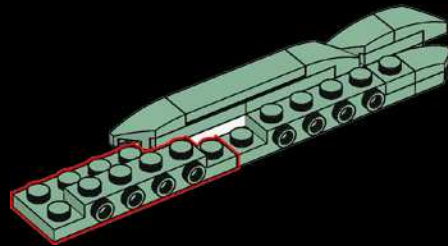

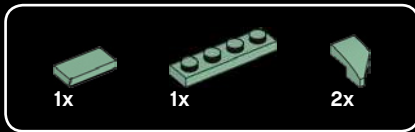

127

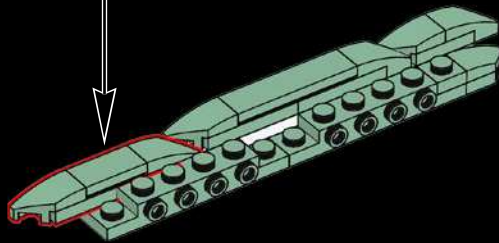
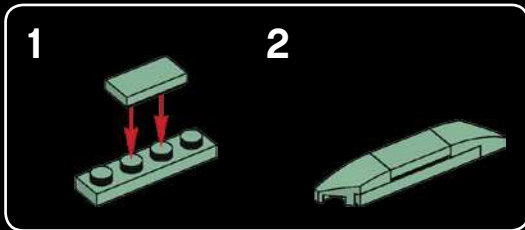

128

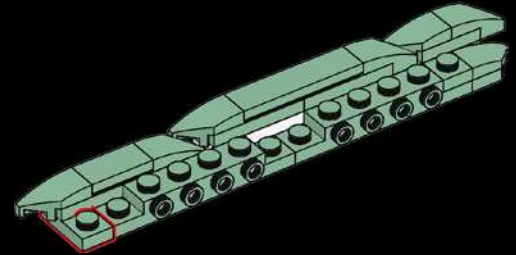

129

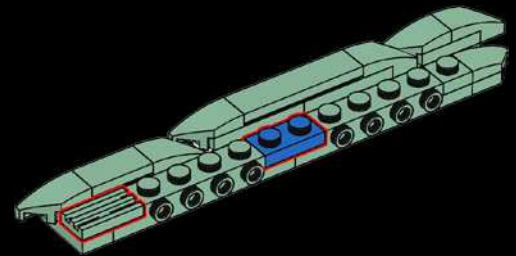

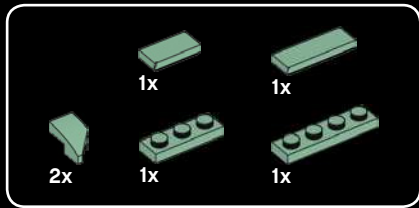

130

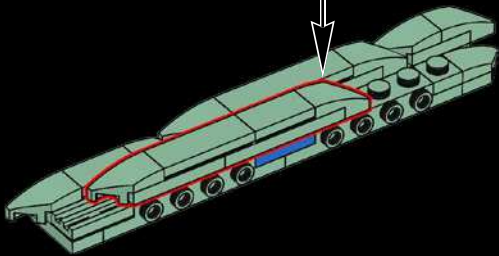
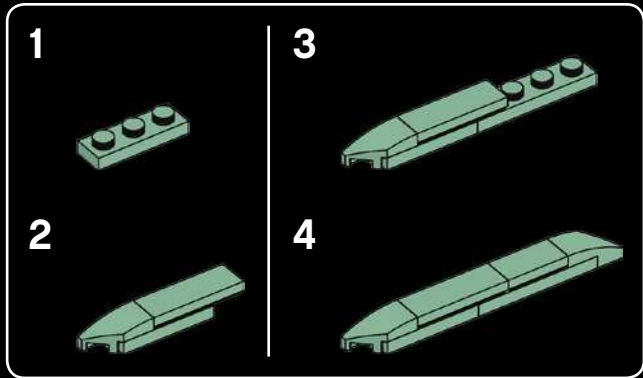

131

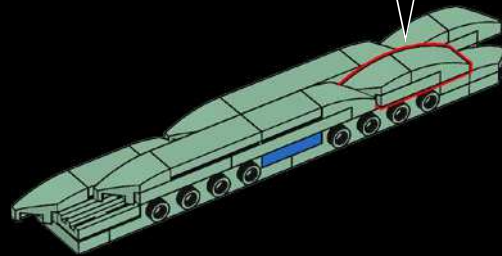

132

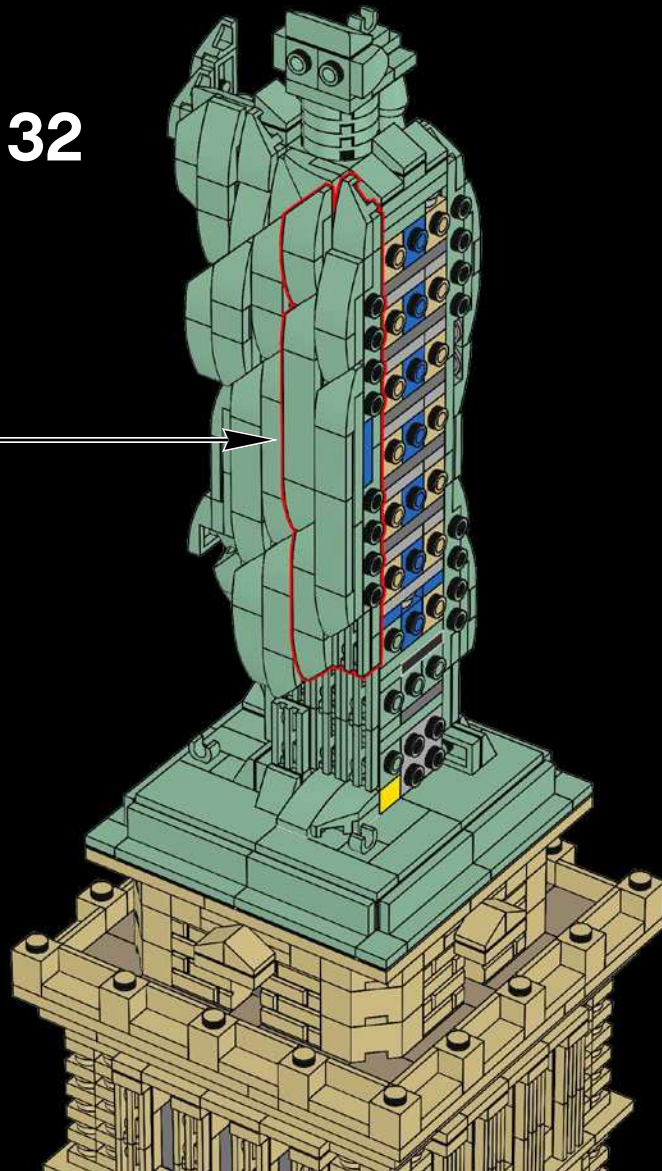

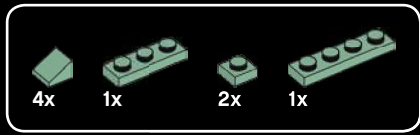

133

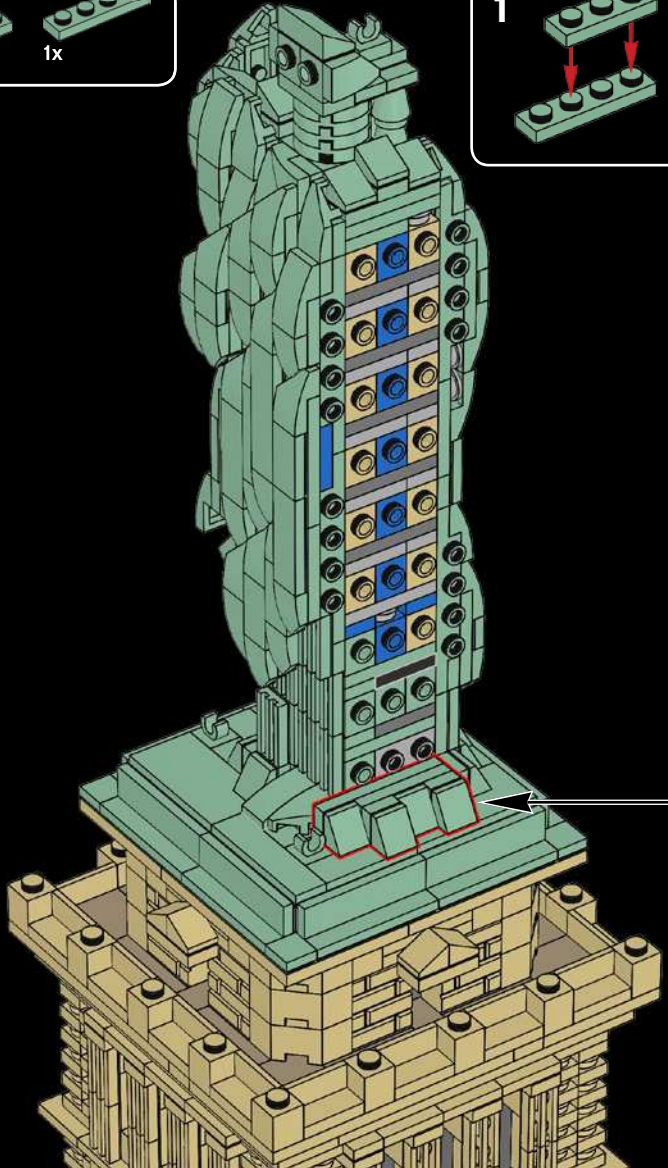
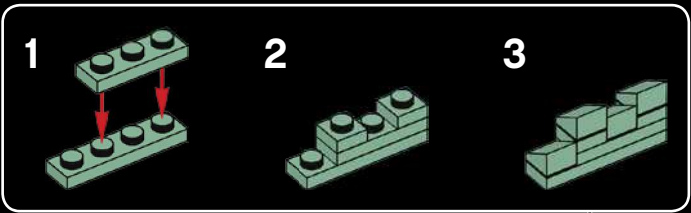

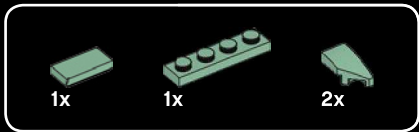

134

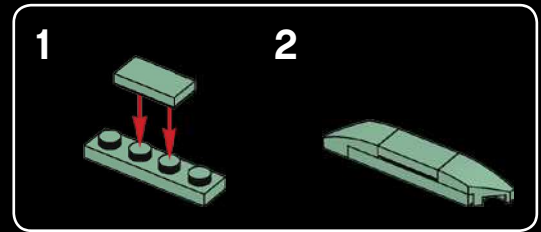
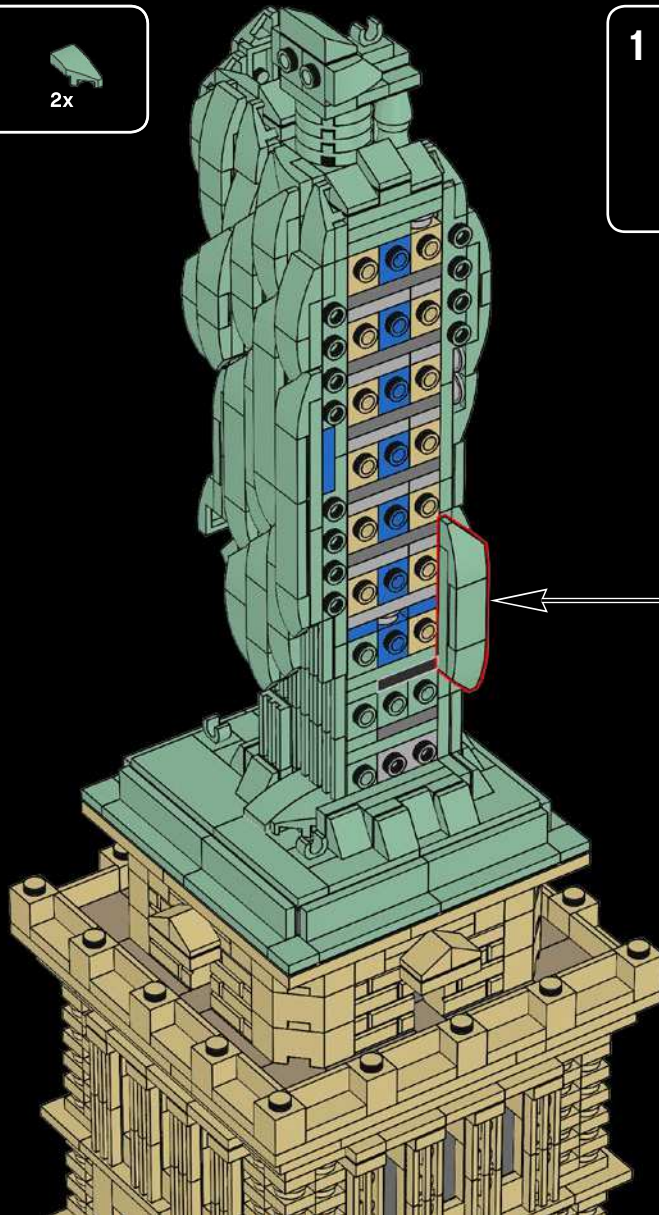

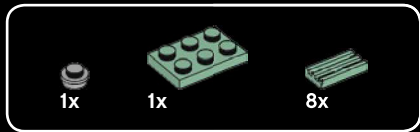

135

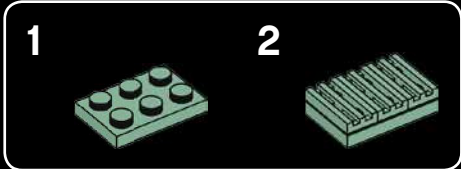
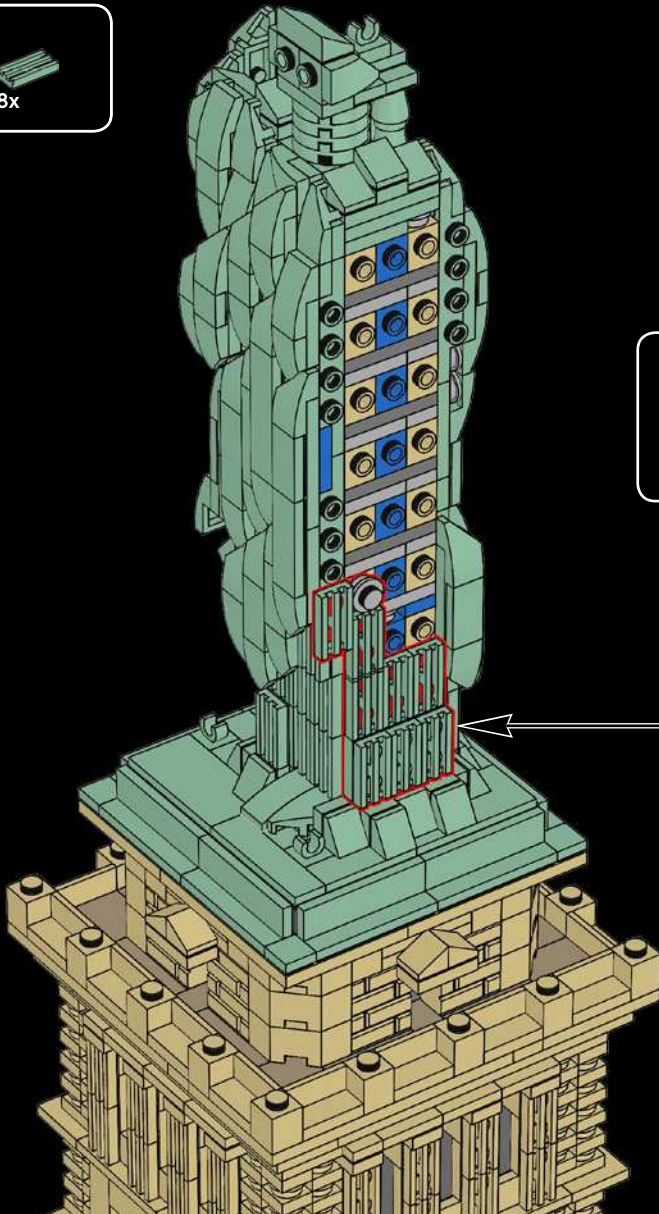

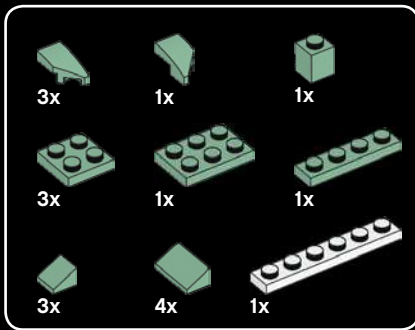

136

1



2

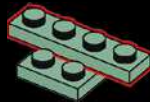

3

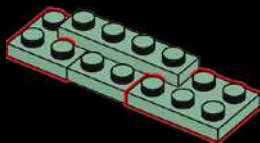

4

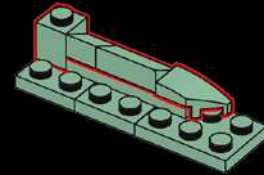

5

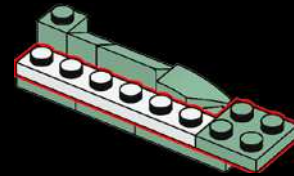

6

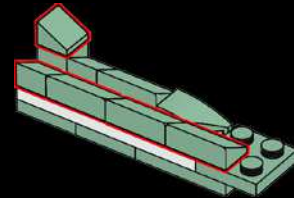

7

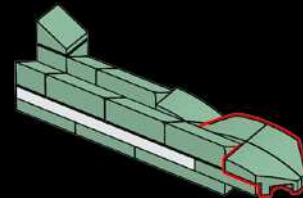

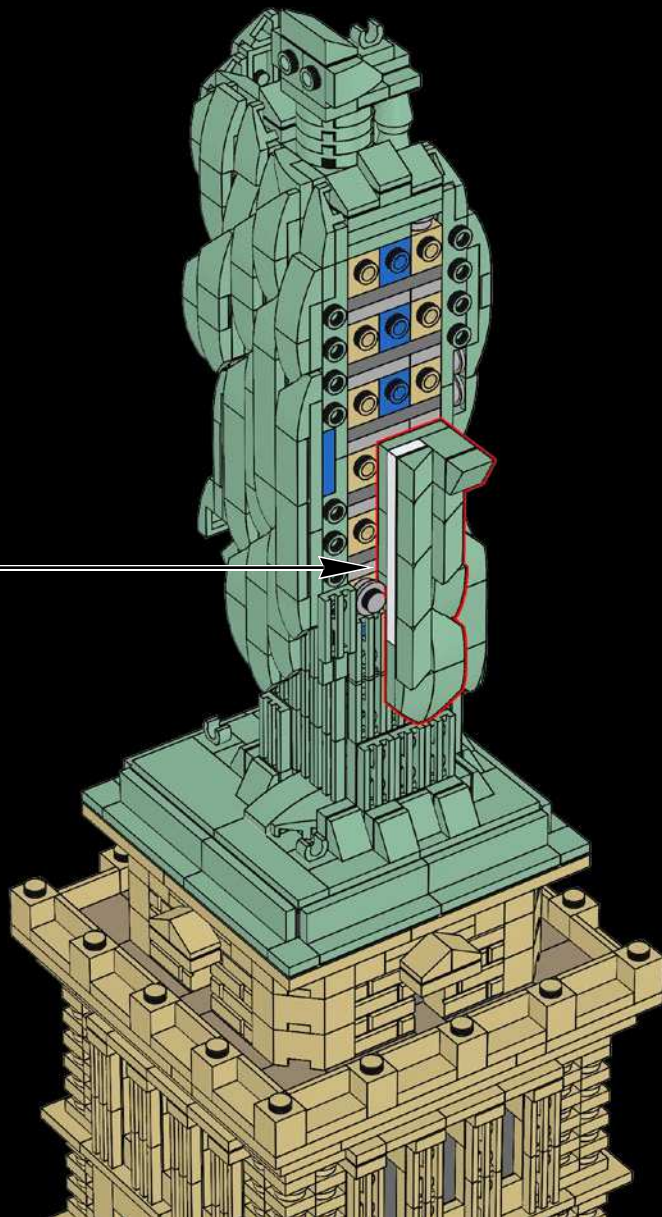

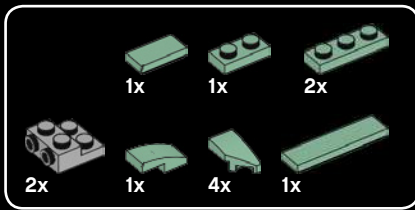

137

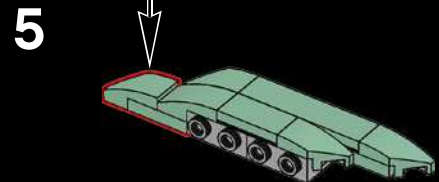
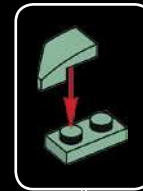
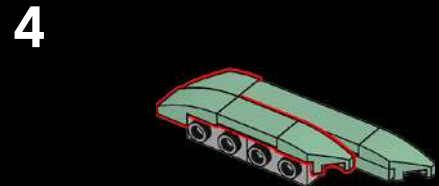
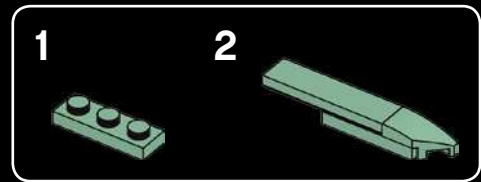
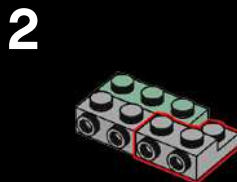
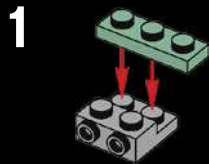

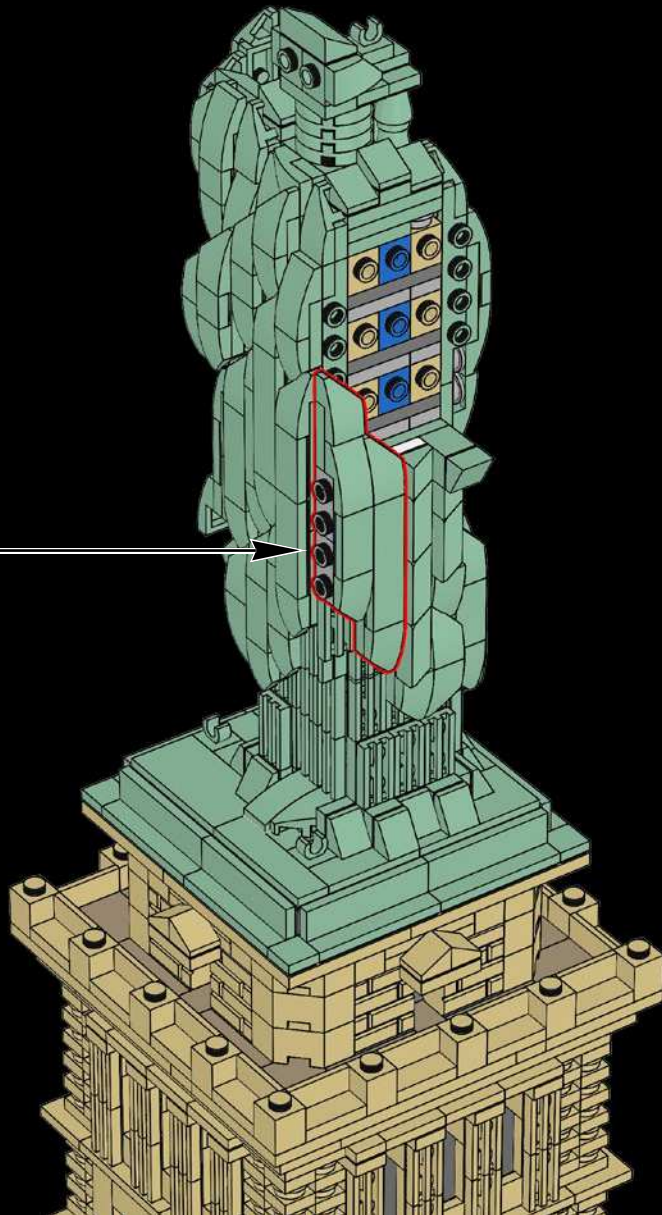

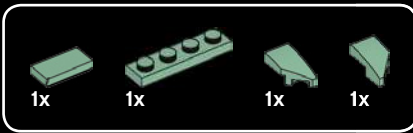

138

The Statue's face was said to be modeled on the sculptor Bartholdi's mother.

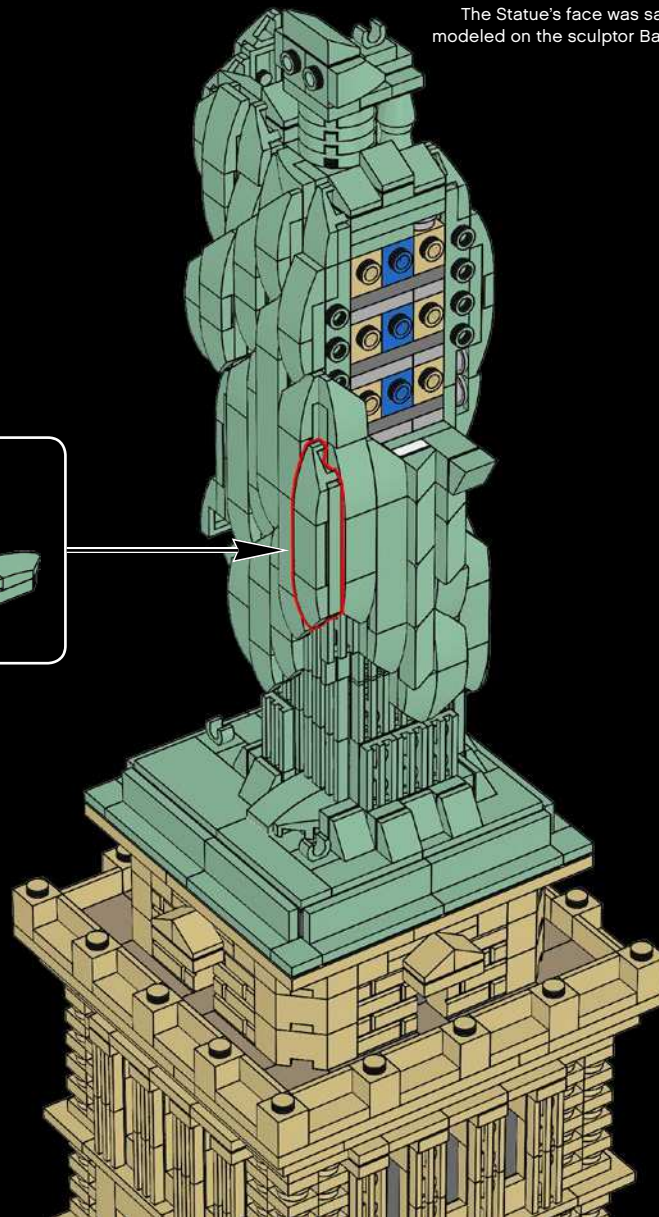
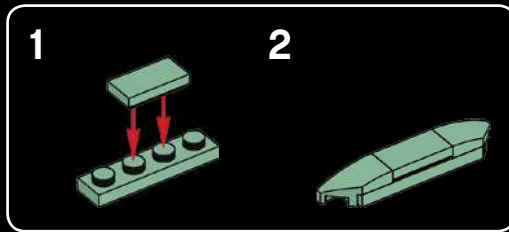



139

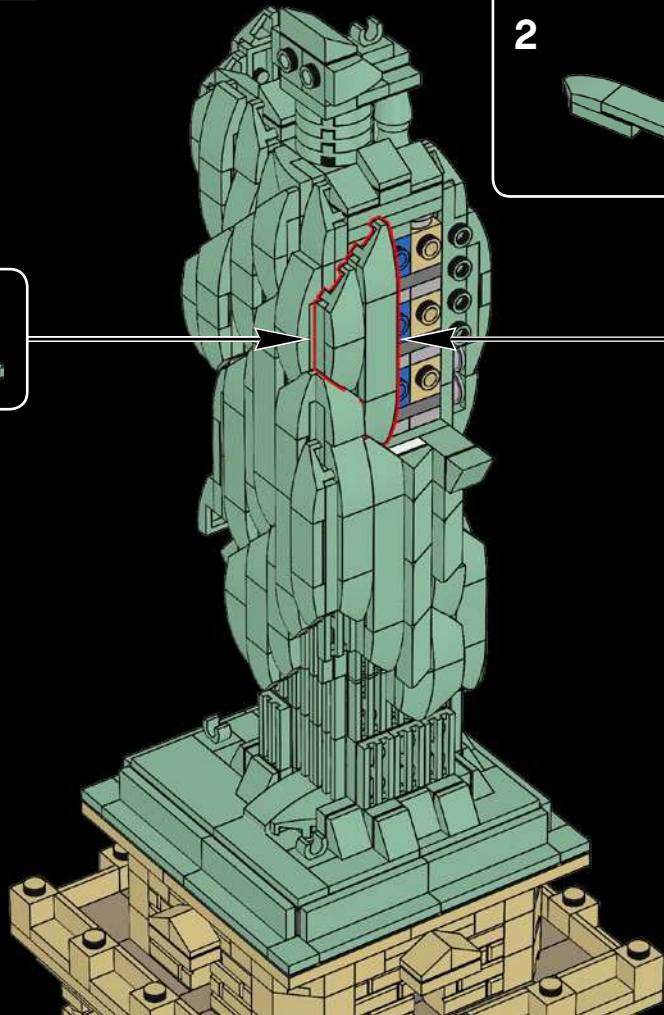
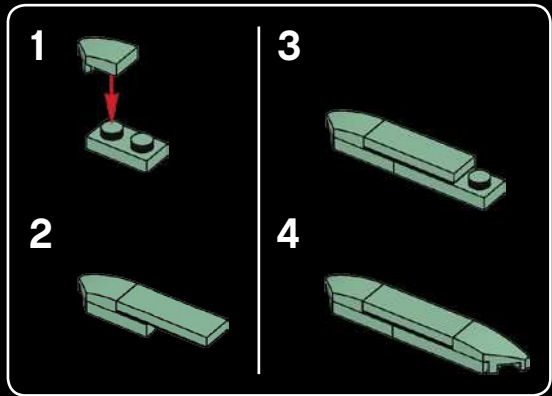

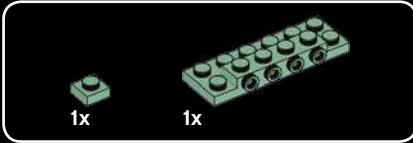

140

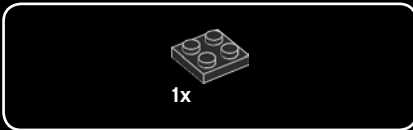
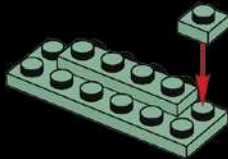

141

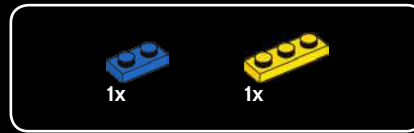
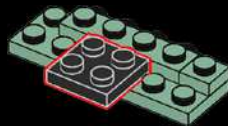

142

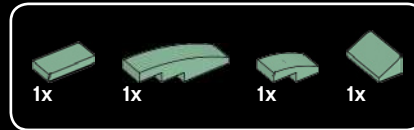
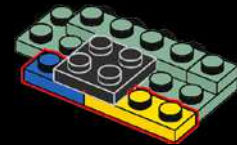

143

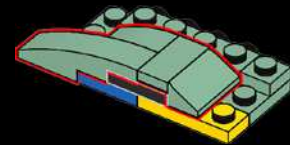



144

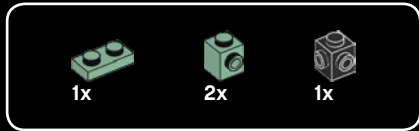
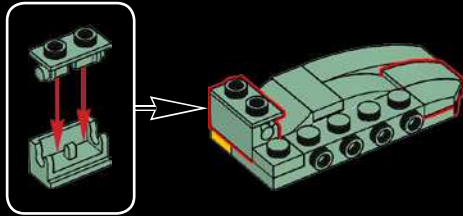

145

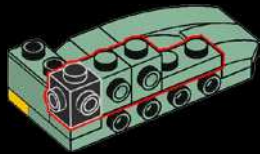

146

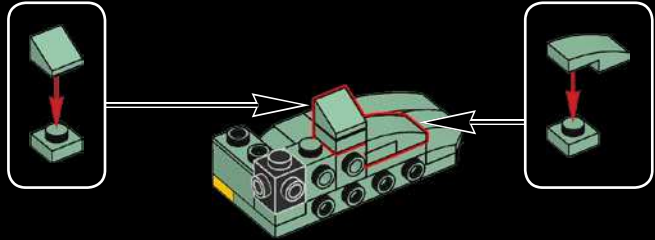

147

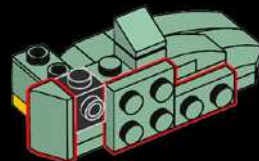



148

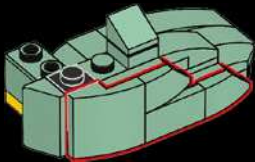

149

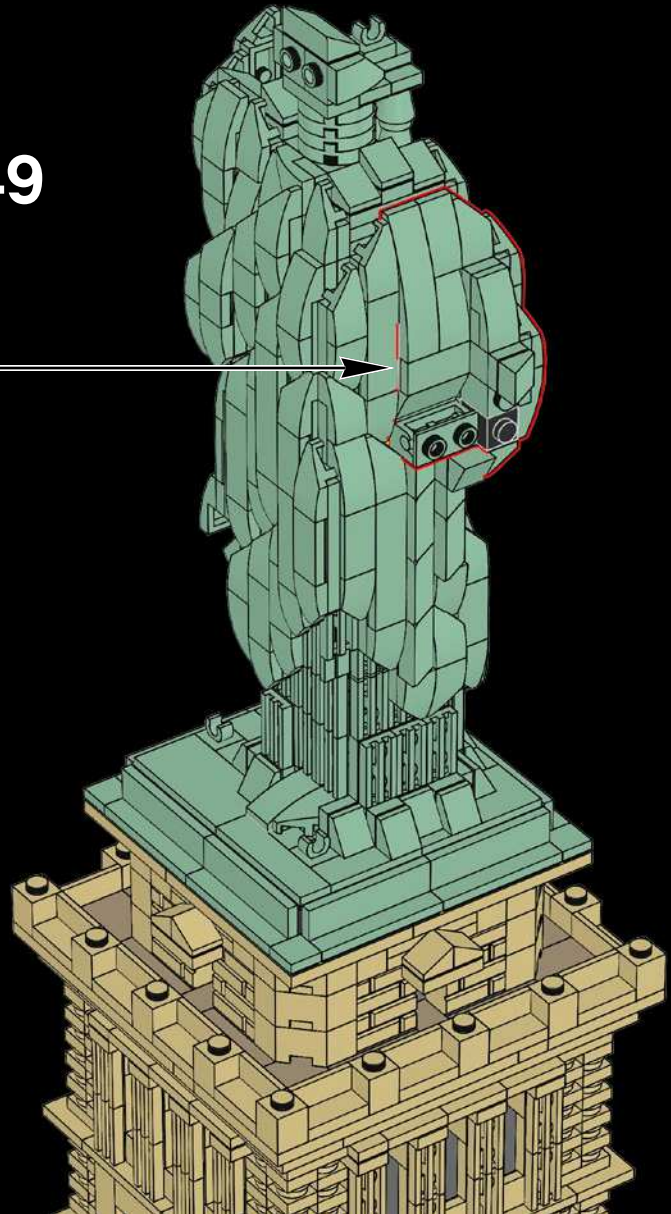

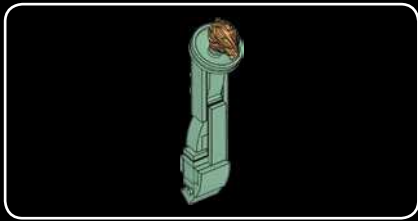

150



151



152



153





1x



1x

154



1x

155



3x



1x

156

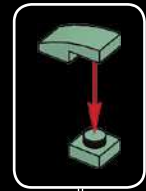
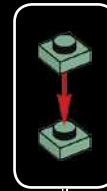



1x



1x

157

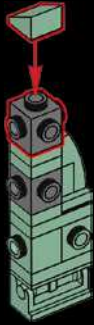

1x



1x

158



2x

159

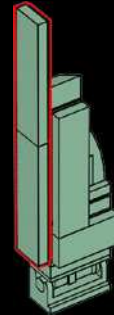

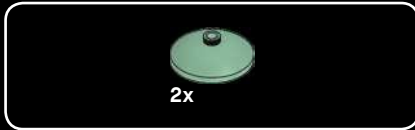

160

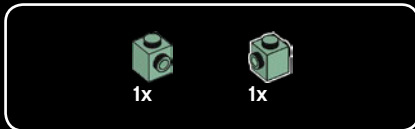
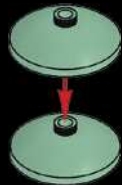

161

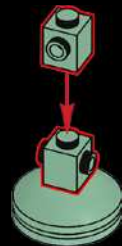

162

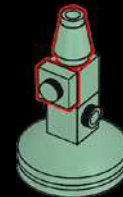

163

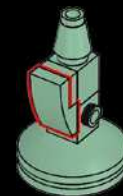



164

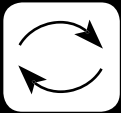
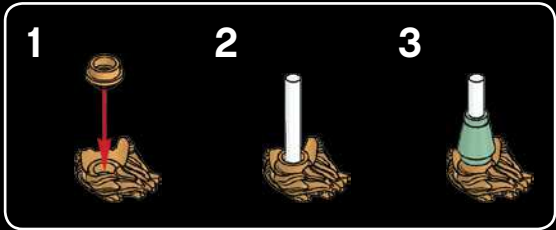

165

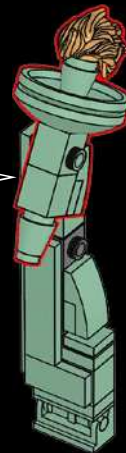

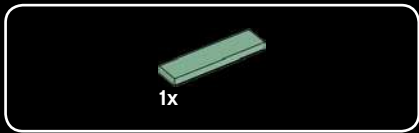

166

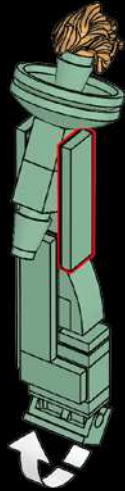

167

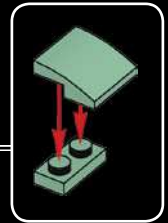
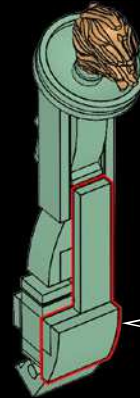
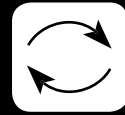

168

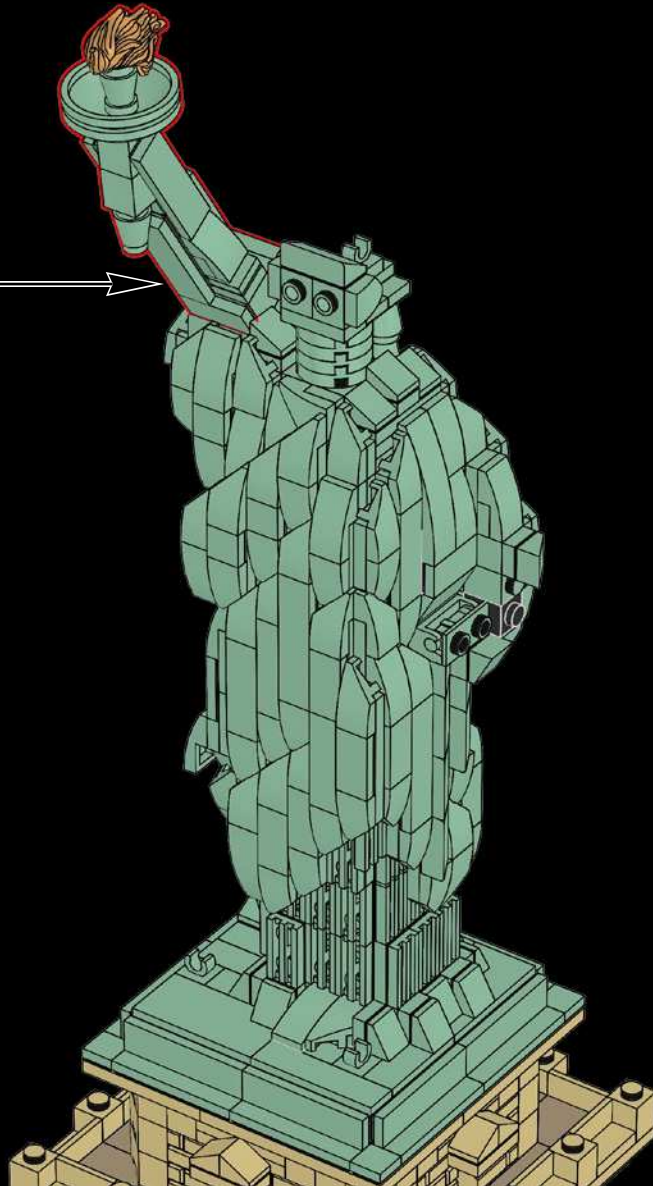

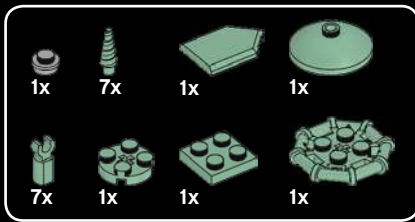

169

1



2



3

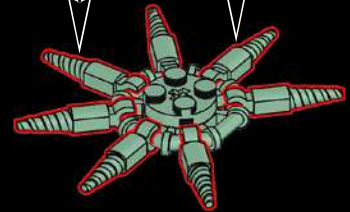

4

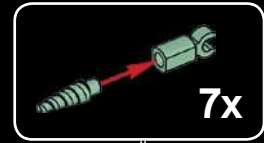
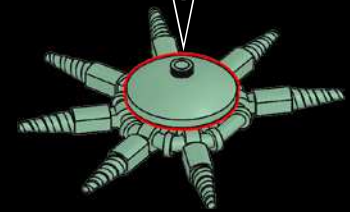

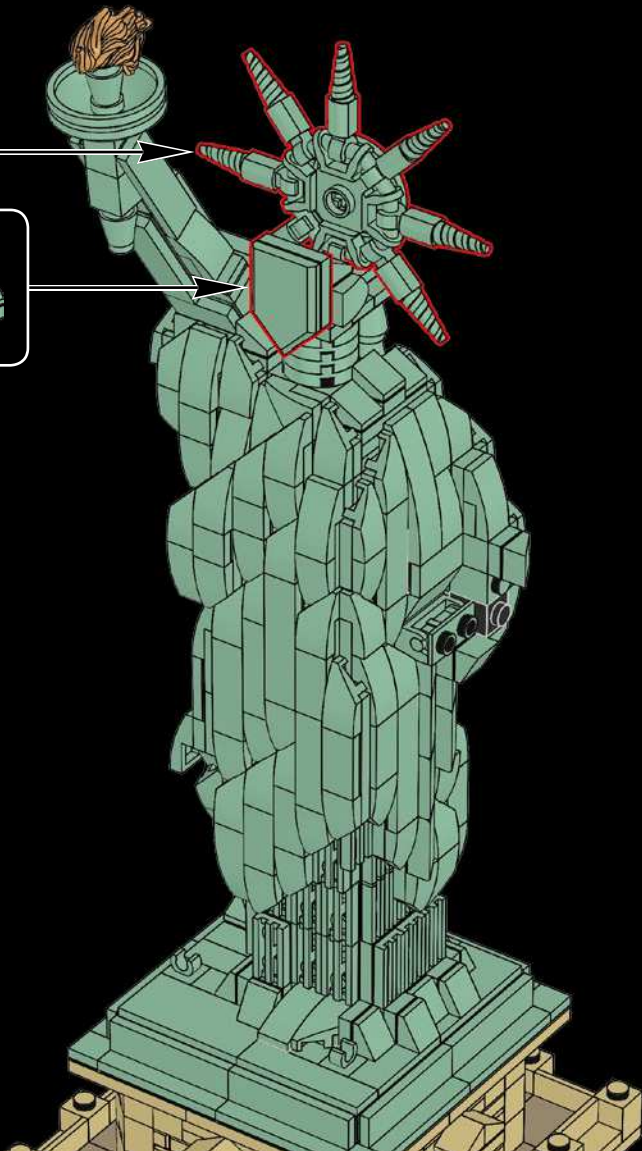
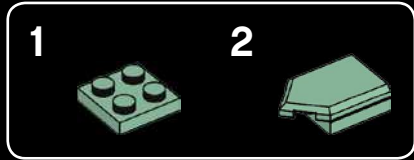

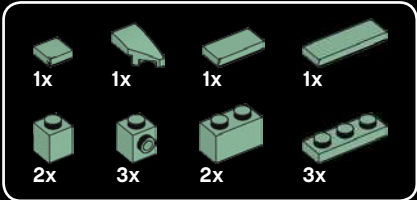
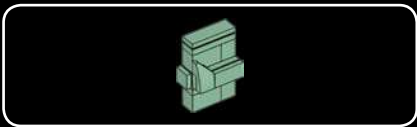

170

1

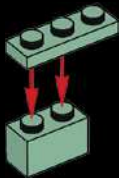

2



3

There are 25 windows in the crown.

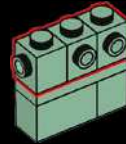

4

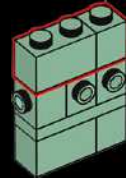

5

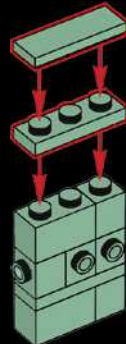

6

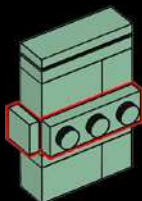

7

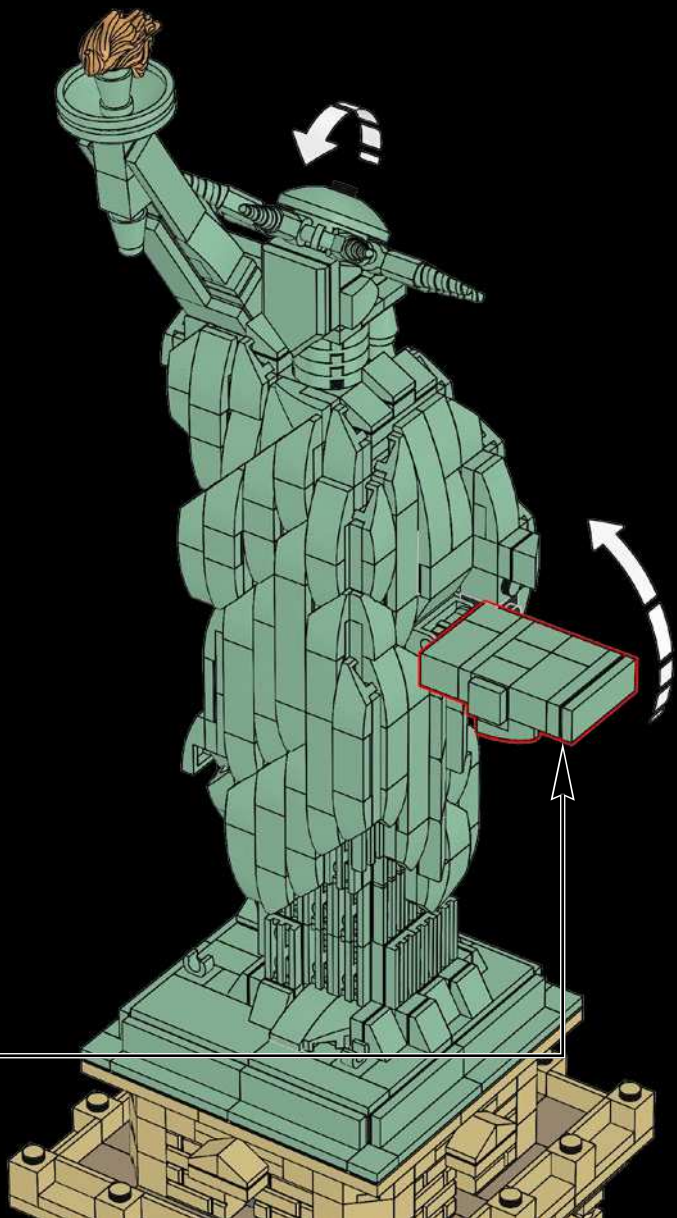
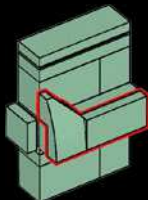



171

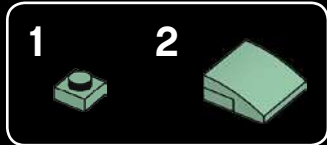
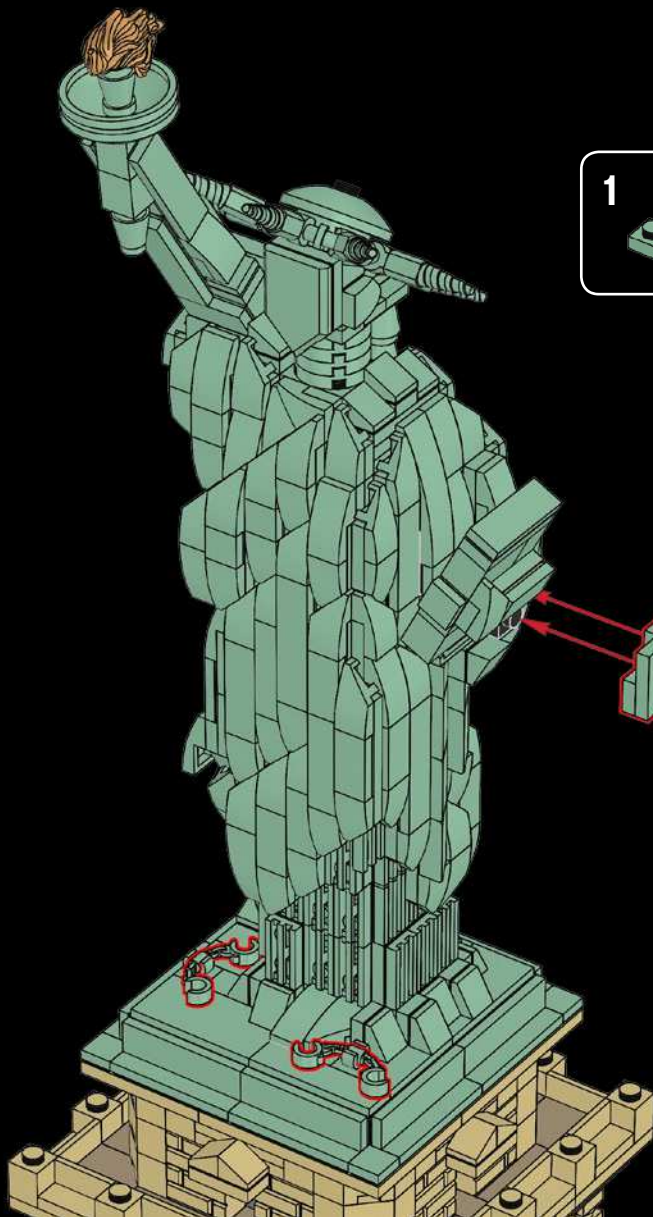

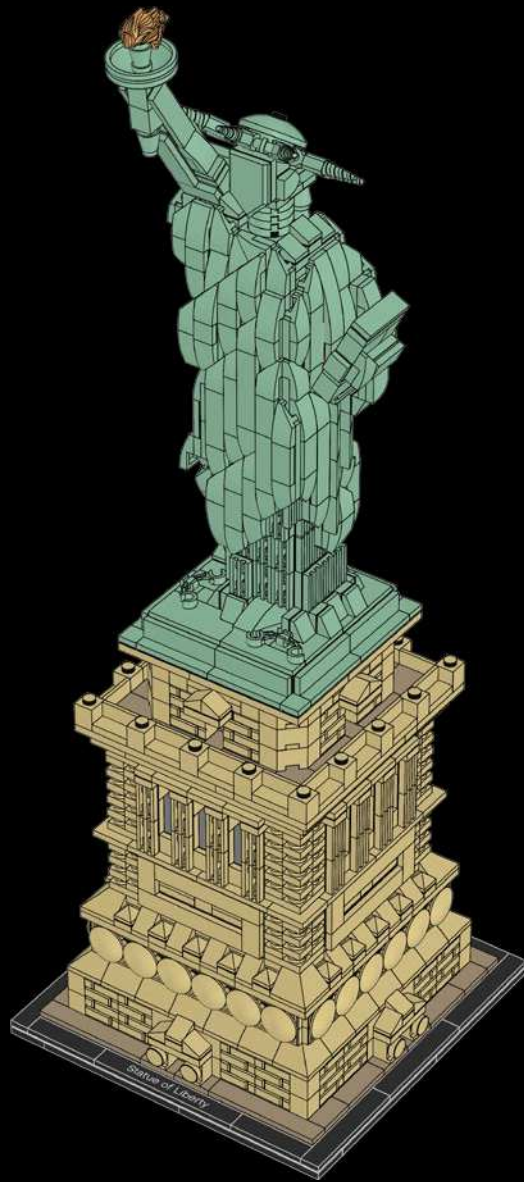

References

Pictures -

© Shutterstock

© Offset

Text -

www.nps.gov

Customer Service
Kundenservice
Service Consommateurs
Servicio Al Consumidor
LEGO.com/service or dial



00800 5346 5555 :

1-800-422-5346 :





LEGO® Architecture – do you like it?

The LEGO Group would like your opinion on the new product you have just purchased. Your feedback will help shape the future development of this product series. Please visit:

[LEGO.com/productfeedback](https://www.lego.com/productfeedback)

By completing our short feedback survey, you will be automatically entered into a drawing to win a LEGO® prize.





LEGO® Architecture

The LEGO® Architecture series creatively captures the essence of many of the world's most iconic landmarks while giving you an enjoyable and engaging LEGO building experience.

Whether your interest is in travel, design, history or architecture, these sets are a physical memento of great trip abroad, a famous building you know well, or a city you still dream of visiting.

Every LEGO Architecture set is designed to be displayed. Much more than just a photo, building and displaying your model on your desk, in the bookcase or on the shelf, lets you be transported every time you admire the view.

Follow us on  

Adam Reed Tucker is the co-developer of the LEGO Architecture product line.



Celebrate the world of architecture and collect all the models

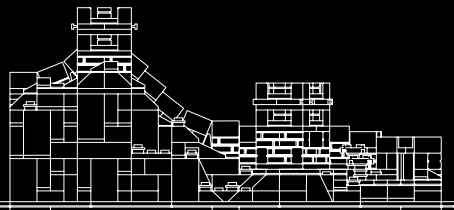

21041
Great Wall of China



21030
United States Capitol Building

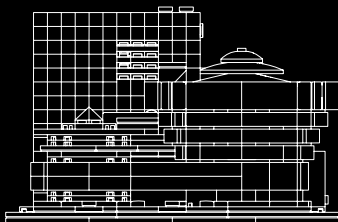

21035
Solomon R. Guggenheim Museum®

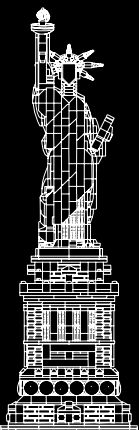

21042
Statue of Liberty

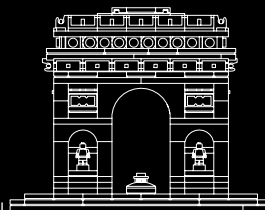

21036
Arc de Triomphe

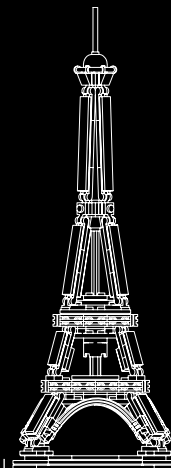

21019
The Eiffel Tower

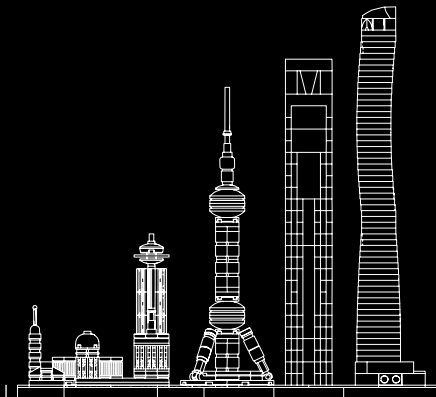

21039
Shanghai

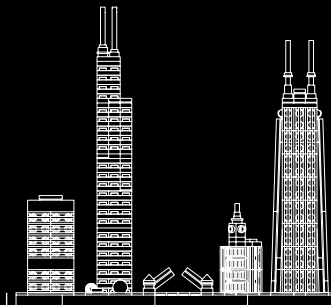

21033
Chicago

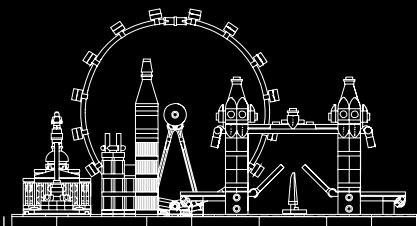

21034
London



21028
New York City

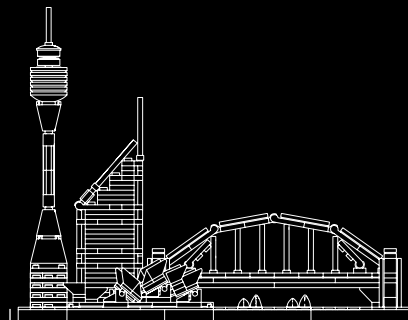

21032
Sydney

8x
4496699

40x
4159553

52x
4113917

12x
4113233

1x
6190252

5x
6187572

56x
614121

8x
6092591

48x
4113915

12x
6148265

4x
4113916

1x
6234261

4x
6157554

6x
4558886

4x
4507045

23x
6175968

32x
4565387

8x
6122047

4x
306224

4x
306926

2x
6135130

12x
6015452

24x
4278422

17x
4114084

8x
4124067

8x
302424

1x
302226

4x
302221

4x
4507047

16x
6069165

20x
4114322

16x
4157277

2x
6206240

7x
242026

4x
300221

96x
4161734

4x
6177314

36x
4114077

4x
4243824

8x
4141630

3x
243126

1x
300121

8x
6139649

48x
6148262

8x
6222431

4x
4114001

2x
242024

8x
663626

4x
300921

8x
4118793

32x
4124456

4x
4162465

12x
4143409

1x
362224

1x
6223269

4x
346021

20x
6177165

4x
6092587

8x
6131896

4x
4509897

1x
362324

8x
303426

3x
6212053

24x
4579260

16x
6146221

36x
4121921

4x
4249019

1x
6240515

8x
4125253

16x
6024495

16x
4118790

20x
4516055

8x
4114026

4x
6175367

7x
6223215

7x
6226411

6x
6134280

40x
6221730

18x
6223913

22x
4652205

25x
6009656

8x
6223225

2x
6125672

3x
6184432

3x
6125669

33x
6099189

3x
4521948

35x
6221729

25x
6210479

5x
6223237

34x
4655080

21x
6223126

6x
4616581

2x
6225000

3x
6223168

17x
4616578

3x
6223234

28x
6196591

6x
6080431

16x
6186823

1x
6186828

3x
6223166

10x
6202626

31x
6069257

1x
6100237

1x
6245273

8x
6184348

1x
6223219

11x
6100234

25x
6192923

4x
6187611

3x
4633693

2x
6194726

6x
6227190

9x
4211525

9x
6123809

1x
4211815

7x
4583862

16x
407023



7x
302323

2x
4558606

2x
4514553

7x
371023

4x
300923

4x
303223

16x
4654577

8x
4211429

6x
4211395

8x
6058177

8x
4113261

1x
6093526

4x
302101

4x
6210105

10x
366601

4x
379501

2x
4211098

12x
4210719

2x
4210700

4x
4211052

4x
4211088

11x
4211063



24x
4211104

8x
4211133

8x
4211053

9x
6039176

1x
4211137

4x
4210706

